

Lumi United Technology Co., Ltd.

CE TEST REPORT

SCOPE OF WORK:

Article 3.2 of RE directive (2014/53/EU) – RF report

Model:

HM1S-G02

REPORT NUMBER

220200836SHA-001

ISSUE DATE

March 17, 2022

DOCUMENT CONTROL NUMBER

TTRF300328-02_V2

© 2018 Intertek



Applicant : Lumi United Technology Co., Ltd.
Room 801-804, Building 1, Chongwen Park, Nanshan iPark, No.3370,
Liuxian Ave, Fuguang Community, Taoyuan Residential District,
Nanshan District, Shenzhen, China.

Manufacturer : Same as applicant

Manufacturing site : Same as applicant

Summary

The equipment complies with the requirements according to the following standard(s) or Specification:

EN 300 328 V2.2.2: Wideband transmission systems; Data transmission equipment operating in the 2,4 GHz band; Harmonised Standard for access to radio spectrum

PREPARED BY:

REVIEWED BY:



Project Engineer
Stephanie Zhang

Reviewer
Wakeyou Wang

This report is for the exclusive use of Intertek's Client and is provided pursuant to the agreement between Intertek and its Client. Intertek's responsibility and liability are limited to the terms and conditions of the agreement. Intertek assumes no liability to any party, other than to the Client in accordance with the agreement, for any loss, expense or damage occasioned by the use of this report. Only the Client is authorized to permit copying or distribution of this report and then only in its entirety. Any use of the Intertek name or one of its marks for the sale or advertisement of the tested material, product or service must first be approved in writing by Intertek. The observations and test results in this report are relevant only to the sample tested. This report by itself does not imply that the material, product, or service is or has ever been under an Intertek certification program.

Contents

REVISION HISTORY	5
MEASUREMENT RESULT SUMMARY	6
1 GENERAL INFORMATION	7
1.1 DESCRIPTION OF EQUIPMENT UNDER TEST (EUT)	7
1.2 RF TECHNICAL INFORMATION	8
1.3 DESCRIPTION OF TEST FACILITY	10
2 TEST SPECIFICATIONS	11
2.1 STANDARDS OR SPECIFICATION	11
2.2 MODE OF OPERATION DURING THE TEST	11
2.3 TEST PERIPHERALS USED	11
2.4 RECORD OF NORMAL AND EXTREME TEST CONDITIONS	12
2.5 INSTRUMENT LIST	13
2.6 MEASUREMENT UNCERTAINTY	14
3 RF OUTPUT POWER	15
3.1 LIMIT	15
3.2 BLOCK DIAGRAM OF TEST SETUP	15
3.2.1 For conducted method	15
3.2.2 For radiated method	16
3.3 TEST CONDITIONS AND TEST METHOD	17
3.4 TEST RESULT.....	18
4 POWER SPECTRAL DENSITY	19
4.1 LIMIT	19
4.2 BLOCK DIAGRAM OF TEST SETUP	19
4.2.1 For conducted method	19
4.2.2 For radiated method	19
4.3 TEST CONDITIONS AND TEST METHOD	20
4.4 TEST RESULT.....	20
<i>Test Graphs</i>	21
5 DUTY CYCLE, TX-SEQUENCE, TX-GAP	23
5.1 LIMIT	23
5.2 BLOCK DIAGRAM OF TEST SETUP	23
5.2.1 For conducted method	23
5.2.2 For radiated method	24
5.3 TEST CONDITIONS AND TEST METHOD	24
5.4 TEST RESULT.....	25
6 MEDIUM UTILISATION (MU) FACTOR	26
6.1 LIMIT	26
6.2 CALCULATION PROCEDURE	26
6.3 TEST RESULT.....	26
7 OCCUPIED CHANNEL BANDWIDTH	27
7.1 LIMIT	27
7.2 BLOCK DIAGRAM OF TEST SETUP	27
7.2.1 For conducted method	27
7.2.2 For radiated method	28
7.3 TEST CONDITIONS AND TEST METHOD	28

TEST REPORT

7.4 TEST RESULT..... 29
Test Graphs 29

8 TRANSMITTER UNWANTED EMISSIONS IN THE OUT-OF-BAND DOMAIN 30

8.1 LIMIT 30
8.2 BLOCK DIAGRAM OF TEST SETUP 30
8.2.1 *For conducted method* 30
8.2.2 *For radiated method* 31
8.3 TEST CONDITIONS AND TEST METHOD 32
8.4 TEST RESULT..... 32
Test Graphs 33

9 TRANSMITTER UNWANTED EMISSIONS IN THE SPURIOUS DOMAIN 35

9.1 LIMIT 35
9.2 BLOCK DIAGRAM OF TEST SETUP 35
9.2.1 *For conducted method* 35
9.2.2 *For radiated method* 36
9.3 TEST CONDITIONS AND TEST METHOD 37
9.4 TEST RESULT..... 38

10 ADAPTIVITY (NON-FHSS) 39

10.1 LIMIT 39
10.2 BLOCK DIAGRAM OF TEST SETUP 40
10.2.1 *For conducted method* 40
10.2.2 *For radiated method* 40
10.3 TEST CONDITIONS AND TEST METHOD..... 41
10.4 TEST RESULT 41

11 RECEIVER BLOCKING 42

11.1 LIMIT 42
11.2 BLOCK DIAGRAM OF TEST SETUP 44
11.2.1 *For conducted method* 44
11.2.2 *For radiated method* 44
11.3 TEST CONDITIONS AND TEST METHOD..... 45
11.4 TEST RESULT 46
Test Graphs 47

12 RECEIVER SPURIOUS EMISSION 48

12.1 LIMIT 48
12.2 BLOCK DIAGRAM OF TEST SETUP 48
12.2.1 *For conducted method* 48
12.2.2 *For radiated method* 49
12.3 TEST CONDITIONS AND TEST METHOD..... 50
12.4 TEST PROTOCOL..... 51
Test Graphs 52

13 GEO-LOCATION CAPABILITY 53

13.1 APPLICABILITY..... 53
13.2 REQUIREMENTS..... 53
13.3 DESCRIPTION 53

APPENDIX I: PHOTOGRAPH OF EQUIPMENT UNDER TEST 54

Revision History

Report No.	Version	Description	Issued Date
220200836SHA-001	Rev. 01	Initial issue of report	March 17, 2022

Measurement result summary

TEST ITEM	TEST RESULT	NOTE
RF Output Power	Pass	
Power Spectral Density	Pass	
Duty Cycle, Tx-sequence, Tx-gap	NA	Only for non-adaptive equipment or mode
Medium Utilization (MU) factor	NA	Only for non-adaptive equipment or mode
Occupied Channel Bandwidth	Pass	
Transmitter unwanted emissions in the out-of-band domain	Pass	
Transmitter unwanted emissions in the spurious domain	Pass	
Adaptivity (non-FHSS)	NA	Not applied for equipment with e.i.r.p. less than 10dBm
Receiver Blocking	Pass	
Receiver spurious emission	Pass	
Geo-location capability	NA	

Notes: 1: NA =Not Applicable

2: Determination of the test conclusion is based on IEC Guide 115 in consideration of measurement uncertainty.

3: Additions, Deviations and Exclusions from Standards: None.

1 GENERAL INFORMATION

1.1 Description of Equipment Under Test (EUT)

Product name : Hub M1S Gen 2

Type/Model : HM1S-G02

Description of EUT : It is a product with WiFi & Zigbee function, there is one model only.
We tested Zigbee in this report.

Rating : 100-240Vac, 50/60Hz,0.2A, Class II

Category of EUT: : Class B

EUT type: : Table top Floor standing

Hardware version : /

Software version : /

Sample received date : 2022.3.3

Date of test : 2022.3.7-2022.3.17

1.2 RF Technical Information

No.	Protocol	Channel Frequency (MHz)	Channel No.
1	Zigbee	2405 - 2475	15

Modulation: GFSK

Antenna information:

No.	Antenna Type	Gain (dBi)	Note
1	PCB	1.00	-

Equipment types

Modulation types:

<input type="checkbox"/>	Frequency Hopping Spread Spectrum (FHSS) equipment, further referred to as FHSS equipment.
<input checked="" type="checkbox"/>	Other types of Wideband Data Transmission equipment, further referred to as non-FHSS equipment (e.g. DSSS, OFDM, etc.).

Adaptive and non-adaptive equipment:

<input type="checkbox"/>	Non-Adaptive Equipment:
<input checked="" type="checkbox"/>	Adaptive Equipment without the possibility to switch to a non-adaptive mode:
<input type="checkbox"/>	Adaptive Equipment which can also operate in non-adaptive mode

Receiver categories:

<input type="checkbox"/>	Receiver category 1: Adaptive equipment with a maximum RF output power greater than 10 dBm e.i.r.p.
<input checked="" type="checkbox"/>	Receiver category 2: <ul style="list-style-type: none"> Non-adaptive equipment with a Medium Utilization (MU) factor greater than 1 % and less than or equal to 10 % (irrespective of the maximum RF output power); or equipment (adaptive or non-adaptive) with a maximum RF output power greater than 0 dBm e.i.r.p. and less than or equal to 10 dBm e.i.r.p.
<input type="checkbox"/>	Receiver category 3: <ul style="list-style-type: none"> Non-adaptive equipment with a maximum Medium Utilization (MU) factor of 1 % (irrespective of the maximum RF output power) or equipment (adaptive or non-adaptive) with a maximum RF output power of 0 dBm e.i.r.p.

Channel	Frequency	Channel	Frequency
11	2405 MHz	19	2445 MHz
12	2410 MHz	20	2450 MHz
13	2415 MHz	21	2455 MHz
14	2420 MHz	22	2460 MHz
15	2425 MHz	23	2465 MHz
16	2430 MHz	24	2470 MHz
17	2435 MHz	25	2475 MHz
18	2440 MHz		

1.3 Description of Test Facility

Name : Intertek Testing Services Shanghai
Address : Building 86, No. 1198 Qinzhou Road(North), Shanghai 200233, P.R. China
Telephone : 86 21 61278200
Telefax : 86 21 54262353

The test facility is recognized, certified, or accredited by these organizations :

- CNAS Accreditation Lab
Registration No. CNAS L0139
- FCC Accredited Lab
Designation Number: CN1175
- IC Registration Lab
CAB identifier.: CN0051
- VCCI Registration Lab
Registration No.: R-14243, G-10845, C-14723, T-12252
- A2LA Accreditation Lab
Certificate Number: 3309.02

Subcontractor

Name : Fangguang Inspection & Testing Co., Ltd.
Address : G9 Building, China Sensor Network International innovation Park, No.200, Linghu Avenue, Wuxi, Jiangsu, China
Telephone : 0510-68790033
Telefax : 0510-68790022

The test facility is recognized, certified, or accredited by these organizations :

- CNAS Accreditation Lab
Registration No. CNAS L9092
- FCC Accredited Lab
Designation Number: CN5037
- NVLAP Lab CODE: 600222-0

2 TEST SPECIFICATIONS

2.1 Standards or specification

EN 300 328 V2.2.2: Wideband transmission systems; Data transmission equipment operating in the 2,4 GHz band; Harmonised Standard for access to radio spectrum

2.2 Mode of operation during the test

While testing transmitting mode of EUT, the continuously transmission was applied by following software.

Software name	Manufacturer	Version	Supplied by
FCC assist	-	V1.0.0.2	Client

The lowest, middle and highest channel were tested as representatives.

Frequency Band (MHz)	Modulation	Lowest (L) (MHz)	Middle (M) (MHz)	Highest (H) (MHz)
2400-2483.5	OQPSK	2405	2440	2475

2.3 Test peripherals used

Item No	Description	Band and Model	S/No
1	Laptop computer	DELL, 5480	NA

2.4 Record of normal and extreme test conditions

Test Item	Normal Temperature (°C)	Relative Humidity (%)
RF Output Power	16	51
Duty Cycle, Tx-sequence, Tx-gap		
Medium Utilization (MU) factor		
Occupied Channel Bandwidth		
Transmitter unwanted emissions in the out-of-band domain		
Hopping Frequency Separation, Accumulated Transmit time, Frequency Occupation and Hopping Sequence		
Adaptivity (non-FHSS)		
Receiver Blocking	15	51
Transmitter unwanted emissions in the spurious domain		
Receiver spurious emission		

Extremes of the operating temperature range as declared by the manufacturer
-10 °C to 40 °C

Abbreviations	
Tnom	Normal Temperature
Tmin	Extreme Low Temperature
Tmax	Extreme High Temperature

2.5 Instrument list

Radiated Emission					
Used	Equipment	Manufacturer	Type	Internal no.	Due date
<input checked="" type="checkbox"/>	Test Receiver	R&S	ESIB 26	EC 3045	2022-09-11
<input checked="" type="checkbox"/>	Bilog Antenna	TESEQ	CBL 6112D	EC 4206	2022-05-29
<input checked="" type="checkbox"/>	Pre-amplifier	R&S	Pre-amp 18	EC5262	2022-06-19
<input type="checkbox"/>	Horn antenna	R&S	HF 906	EC 3049	2022-11-17
<input type="checkbox"/>	Horn antenna	ETS	3117	EC 4792-1	2023-01-09
<input type="checkbox"/>	Horn antenna	TOYO	HAP18-26W	EC 4792-3	2022-07-08
<input type="checkbox"/>	Pre-amplifier	R&S	Pre-amp 18	EC5262	2022-06-19
<input type="checkbox"/>	Active loop antenna	Schwarzbeck	FMZB1519	EC 5345	2023-03-07
RF test					
Used	Equipment	Manufacturer	Type	Internal no.	Due date
<input checked="" type="checkbox"/>	PXA Signal Analyzer	Keysight	N9030A	EC 5338	2023-03-05
<input checked="" type="checkbox"/>	Power sensor	Agilent	U2021XA	EC 5338-1	2023-03-05
<input checked="" type="checkbox"/>	MXG Analog Signal Generator	Agilent	N5181A	EC 5338-2	2023-03-05
<input checked="" type="checkbox"/>	Vector Signal Generator	Agilent	N5182B	EC 5175	2023-03-05
<input checked="" type="checkbox"/>	Power meter	Keysight	N1911A	EC 4318	2022-05-11
<input type="checkbox"/>	Wideband Radio Communication Tester	R&S	CMW500	EC 5944	2022-12-07
<input type="checkbox"/>	Mobile Test System	LitePoint	IQxel	EC 5176	2023-01-09
<input type="checkbox"/>	Test Receiver	R&S	ESCI 7	EC 4501	2022-09-11
<input type="checkbox"/>	Spectrum analyzer	Agilent	E7402A	EC 2254	2022-09-11
Additional instrument					
Used	Equipment	Manufacturer	Type	Internal no.	Due date
<input type="checkbox"/>	Therom-Hygrograph	ZJ1-2A	S.M.I.F.	EC 3323	2022-06-13
<input checked="" type="checkbox"/>	Therom-Hygrograph	ZJ1-2A	S.M.I.F.	EC 3324	2022-04-08
<input type="checkbox"/>	Therom-Hygrograph	ZJ1-2A	S.M.I.F.	EC 3325	2023-03-22
<input checked="" type="checkbox"/>	Therom-Hygrograph	ZJ1-2A	S.M.I.F.	EC 3326	2023-03-27

2.6 Measurement Uncertainty

Item No.	Test Items	Expanded Uncertainty (k=2)
1	Radio frequency	$\pm 0.84 \times 10^{-7}$
2	RF power, conducted	± 0.74 dB
3	RF power, radiated	± 5.92 dB
4	Maximum Frequency Deviation	± 2.77 %
5	Adjacent channel power	± 1.45 dB
6	Spurious emissions of transmitter, conducted	± 2.89 dB
7	Spurious emissions of receiver, conducted	± 2.80 dB
8	Spurious emissions, radiated	± 5.93 dB
9	Power Spectral Density, conducted	± 2.99 dB
10	Occupied Channel Bandwidth	± 0.88 %
11	Time	± 1.15 %
12	Temperature	± 1 °C
13	Humidity	± 5 %
14	DC and low frequency voltages	± 1.3 %

3 RF output power

Test result: Pass

3.1 Limit

Mode	Limit	
	(mW)	(dBm)
Adaptive	100	20
Non-adaptive	100	20

Note: the limit for non-adaptive device is declared by the applicant.

3.2 Block Diagram of Test Setup

3.2.1 For conducted method

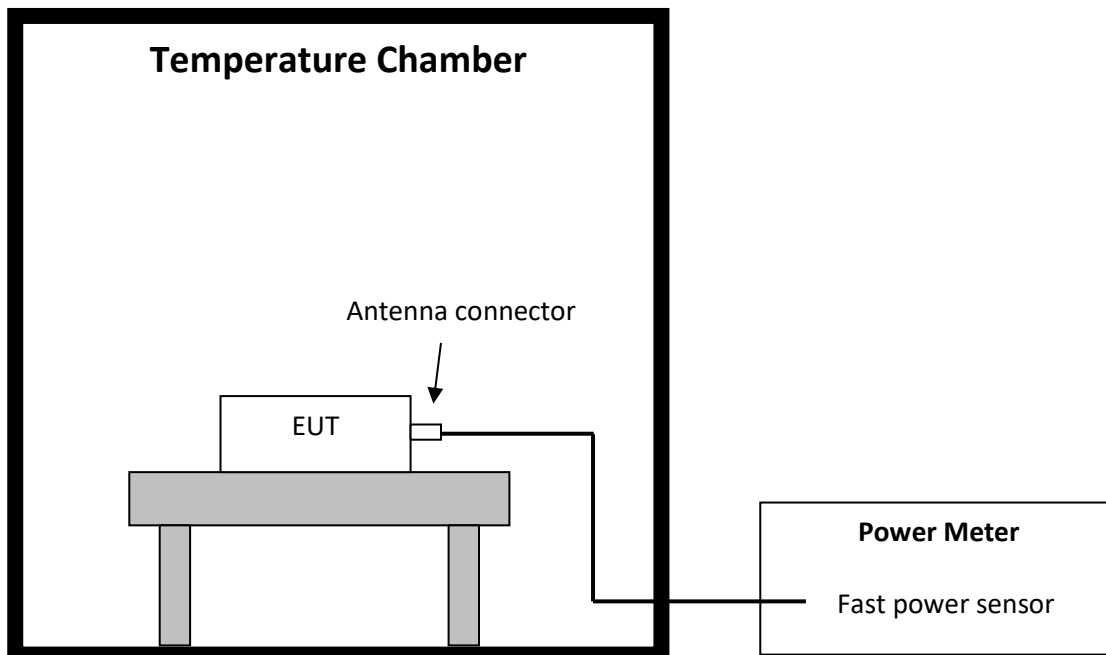

3.2.2 For radiated method

Step one

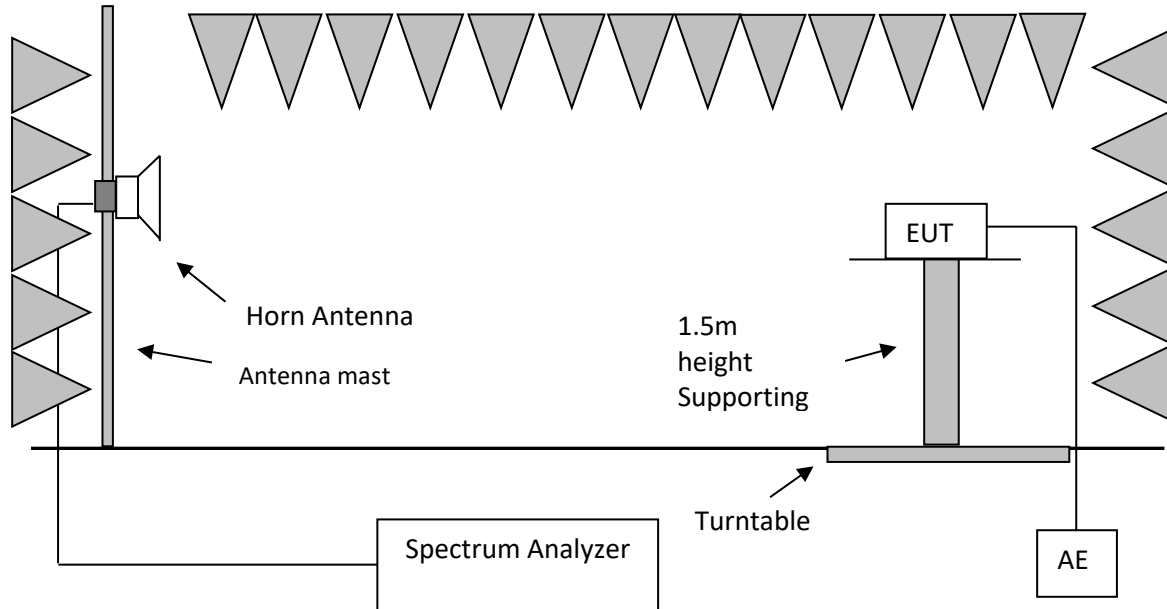

Step two

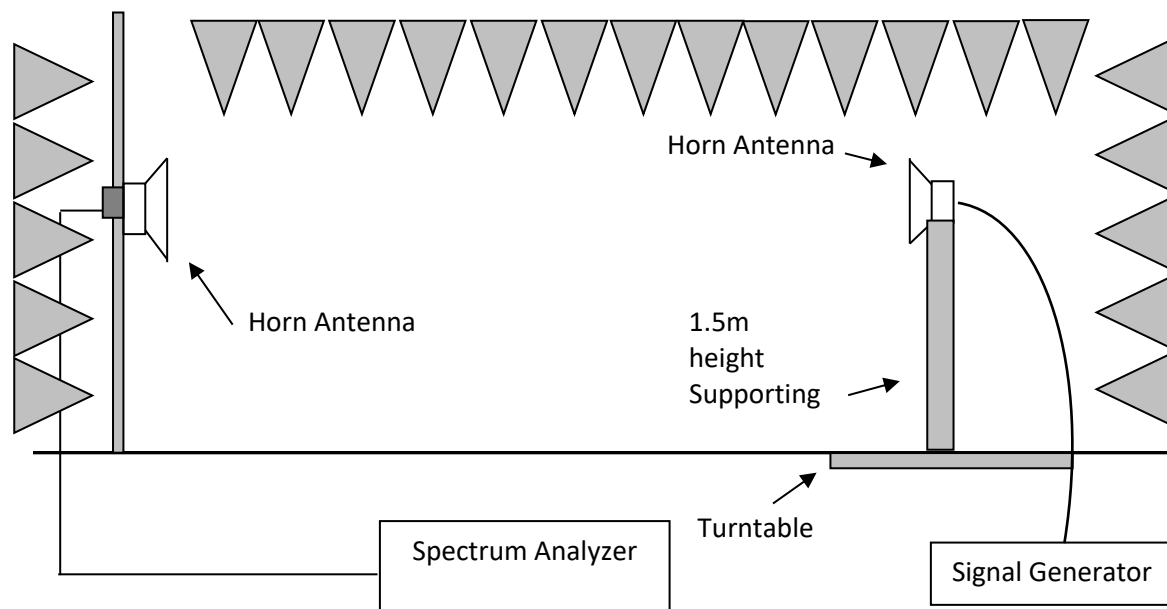

Step three

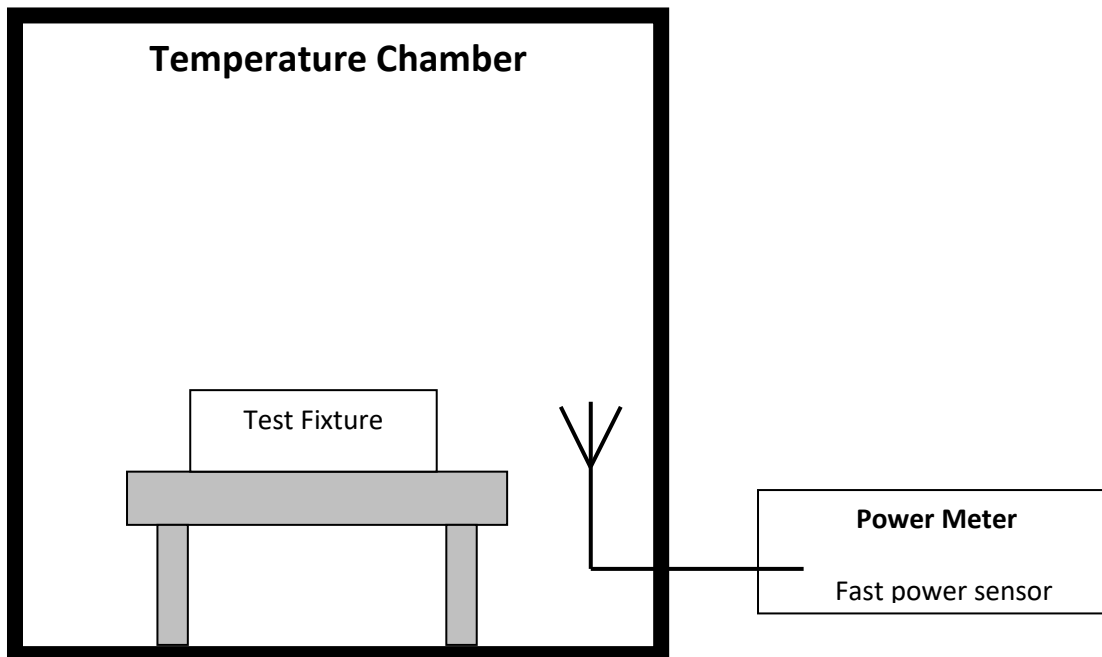

3.3 Test Conditions and Test Method

The measurements for RF output power shall be performed at both normal environmental conditions and at the extremes of the operating temperature range.

In case of Adaptive equipment, the equipment shall be operated under its worst case configuration w.r.t. RF output power. In case of non-Adaptive equipment, the equipment shall be operated under its worst case configuration w.r.t. Medium Utilization factor.

For FHSS equipment, the measurements shall be performed during normal operation (hopping) and the equipment is assumed to have no blacklisted frequencies (operating on all hopping frequencies).

For non-FHSS equipment, the measurement shall be performed at the lowest, the middle, and the highest channel on which the equipment can operate. These frequencies shall be recorded.

For conducted method

The EUT was connected to the power meter directly. Please refer to EN 300 328 Clause 5.4.2.2.1 for test method.

For radiated method

The measurement was applied in a semi-anechoic chamber. Please refer to EN 300 328 Clause 5.4.2.2.2 and for test method.

3.4 Test Result

Mode	Channel	Condition	EIRP (dBm)	Limit (dBm)	Pass/Fail
Zigbee	L	Tnom	9.43	20	Pass
		Tmin	9.08		
		Tmax	9.11		
	M	Tnom	9.60	20	Pass
		Tmin	9.22		
		Tmax	9.44		
	H	Tnom	9.81	20	Pass
		Tmin	9.32		
		Tmax	9.79		

4 Power Spectral Density

Test result: Pass

4.1 Limit

The maximum Power Spectral Density for non-FHSS equipment is 10 dBm per MHz.

4.2 Block Diagram of Test Setup

4.2.1 For conducted method

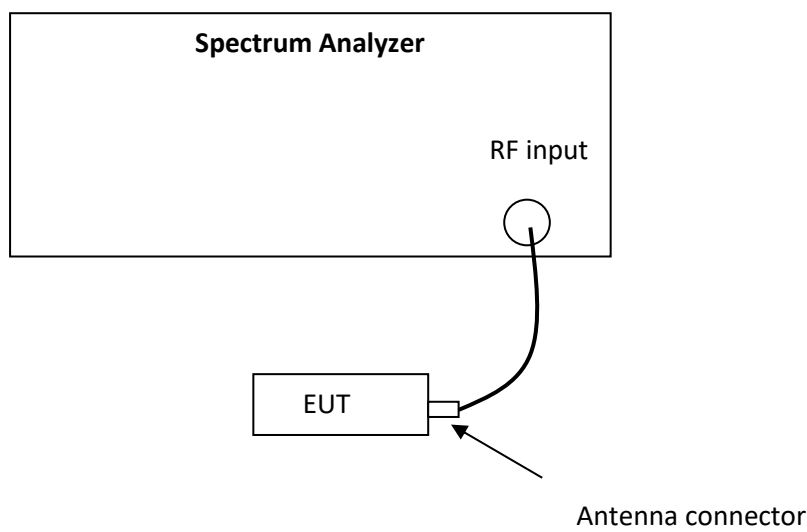

4.2.2 For radiated method

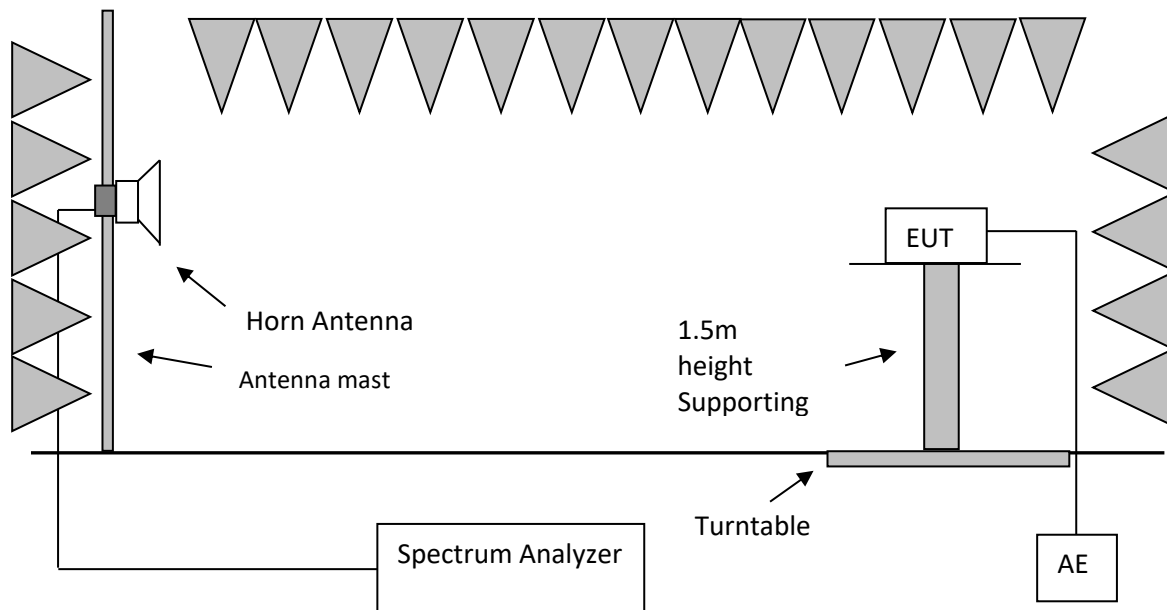

4.3 Test Conditions and Test Method

These measurements shall only be performed at normal test conditions.

The measurement shall be repeated for the equipment being configured to operate at the lowest, the middle, and the highest frequency of the stated frequency range. These frequencies shall be recorded.

For conducted method

The EUT was connected to the spectrum analyzer directly. Please refer to EN 300 328 Clause 5.4.3.2.1 for test method.

For radiated method

The measurement was applied in a semi-anechoic chamber. Please refer to EN 300 328 Clause 5.4.3.2.2 for test method.

4.4 Test Result

Mode	Channel	Power Density (dBm/MHz)	Limit (dBm/MHz)	Pass/Fail
Zigbee	L	7.58	10	Pass
	M	7.77	10	Pass
	H	8.22	10	Pass

Test Graphs

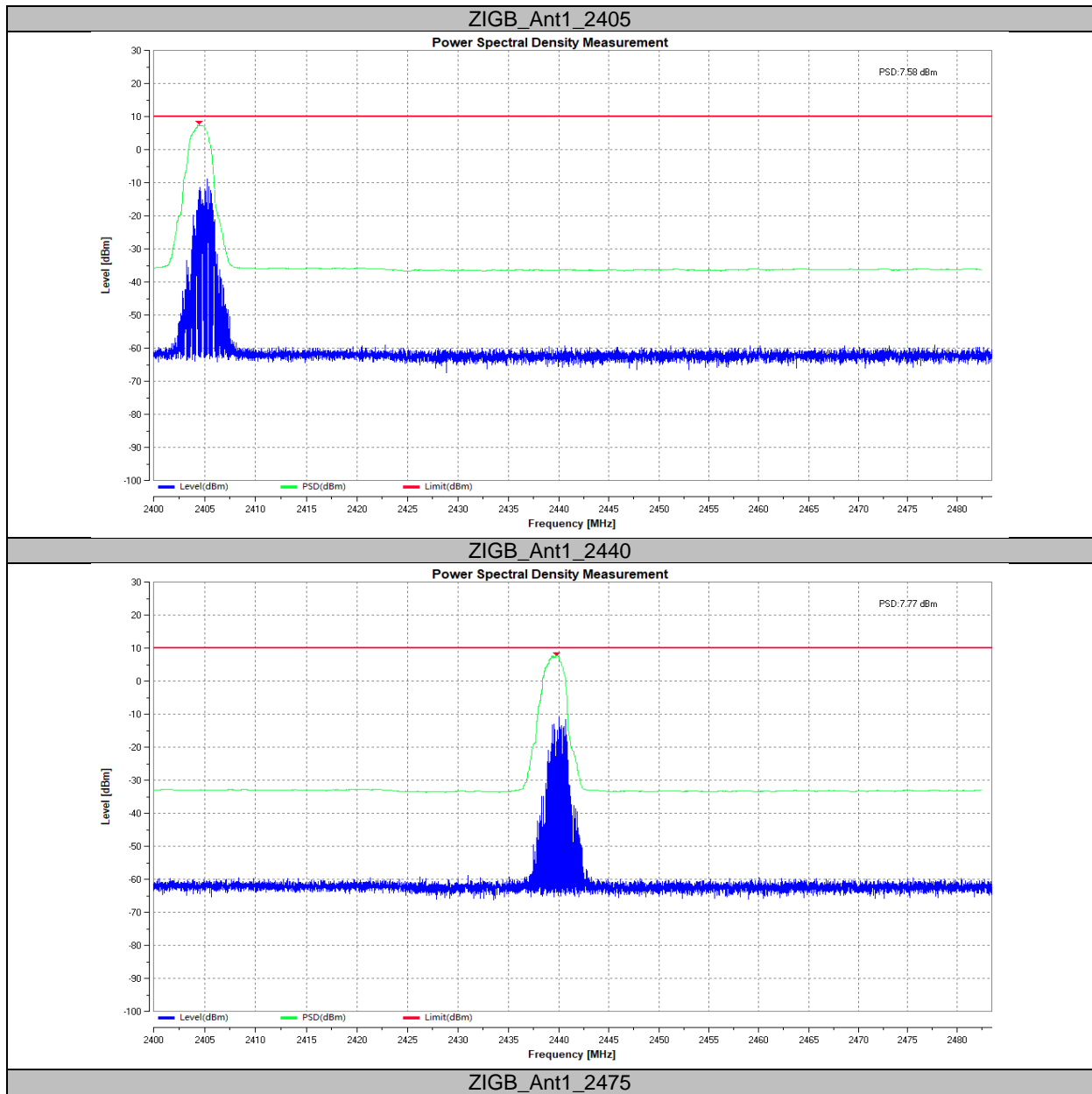

TEST REPORT

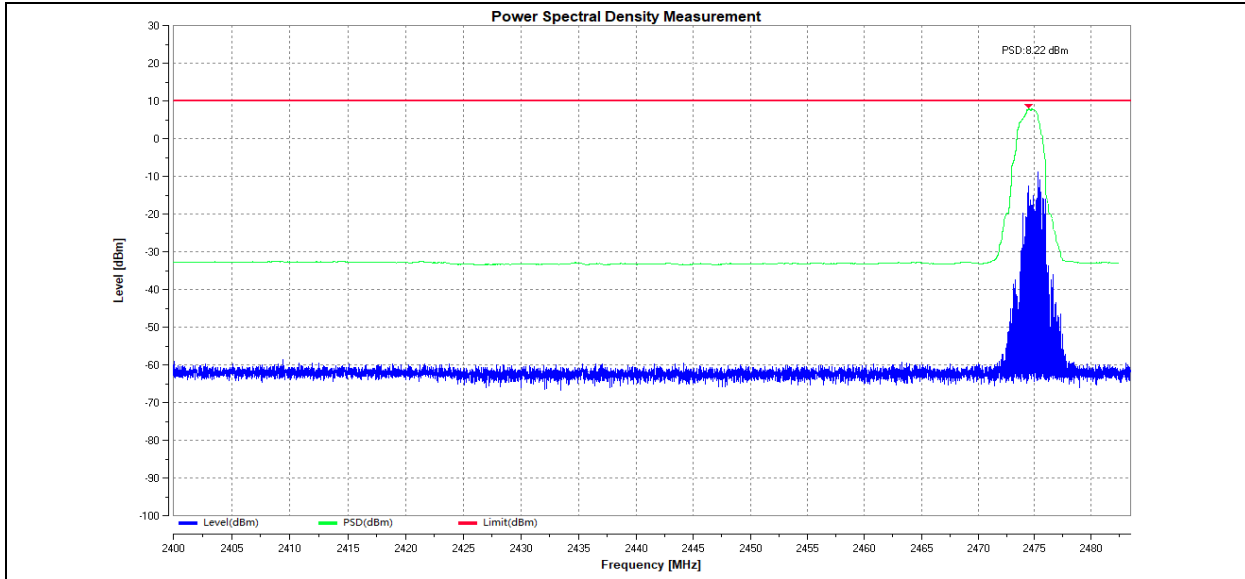

5 Duty Cycle, Tx-sequence, Tx-gap

Test result: NA

5.1 Limit

Mode	Maximum Duty Cycle (%)	Maximum Tx-sequence (ms)	Minimum Tx-gap (ms)
Non-adaptive	100	10	3.5

Note: 1. The limit for maximum duty cycle is declared by the applicant.
 2. This test is not applied to the device / mode with EIRP less than 10dBm.

5.2 Block Diagram of Test Setup

5.2.1 For conducted method

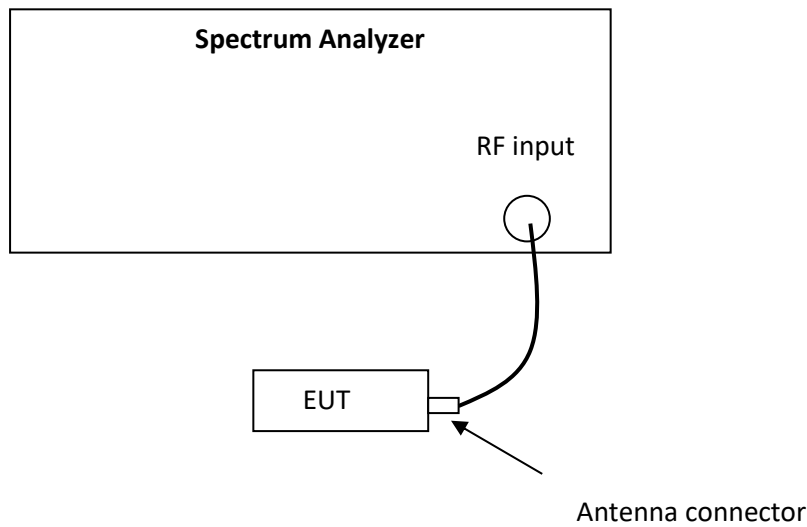

5.2.2 For radiated method

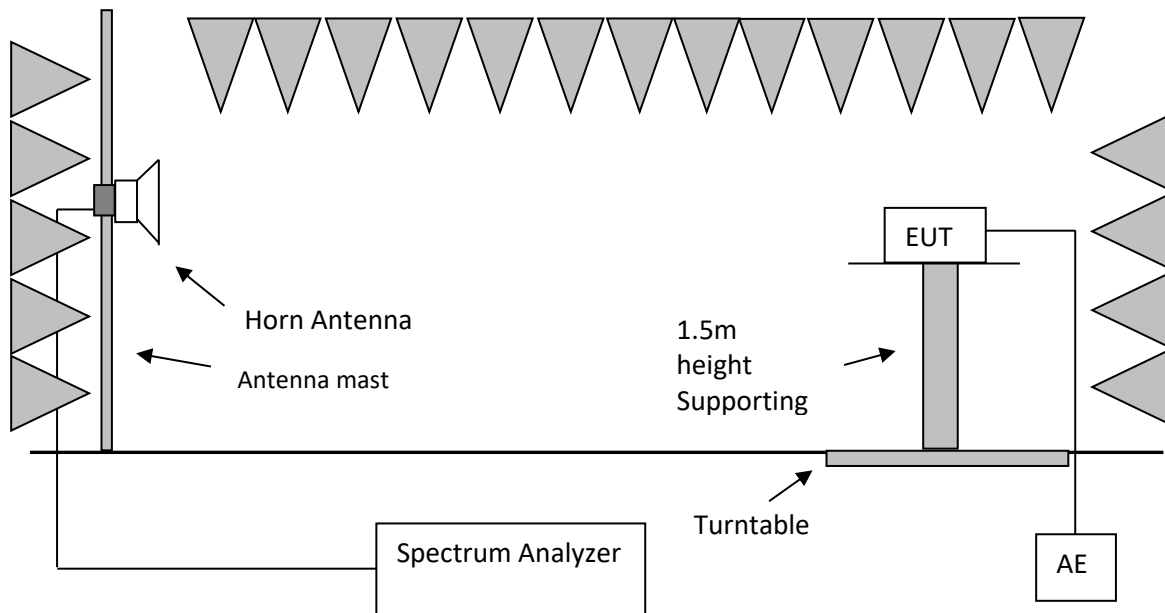

5.3 Test Conditions and Test Method

These measurements shall only be performed at normal test conditions.

In case of Adaptive equipment, the equipment shall be operated under its worst case configuration w.r.t. RF output power.

In case of non-Adaptive equipment, the equipment shall be operated under its worst case configuration w.r.t. Medium Utilization factor.

For FHSS equipment, the measurements shall be performed during normal operation (hopping) and the equipment is assumed to have no blacklisted frequencies (operating on all hopping frequencies).

For non-FHSS equipment, the measurement shall be performed at the lowest, the middle, and the highest channel on which the equipment can operate. These frequencies shall be recorded.

For conducted method

The EUT was connected to the power meter directly. Please refer to EN 300 328 Clause 5.4.2.2.1 for test method.

For radiated method

The measurement was applied in a semi-anechoic chamber. Please refer to EN 300 328 Clause 5.4.2.2.2 and for test method.

5.4 Test Result

Maximum Duty Cycle			
Channel	Observed value (%)	Limit (%)	Pass/Fail
L		100	
M			
H			

Maximum Tx-sequence			
Channel	Observed value (ms)	Limit (ms)	Pass/Fail
L		10	
M			
H			

Minimum Tx-gap			
Channel	Observed value (ms)	Limit (ms)	Pass/Fail
L		3.5	
M			
H			

6 Medium Utilisation (MU) factor

Test result: NA

6.1 Limit

Mode	Maximum MU factor (%)
Non-adaptive	10

Note: this requirement does not apply for non-FHSS equipment with a maximum declared RF Output power level of less than 10 dBm e.i.r.p. or for non-FHSS equipment when operating in a mode where the RF Output power is less than 10 dBm e.i.r.p.

6.2 Calculation Procedure

MU factor = (RF output power / 100 mW) * Duty Cycle

6.3 Test Result

MU factor			
Channel	Calculated value (%)	Limit (%)	Pass/Fail
L		≤ 10	
M			
H			

7 Occupied Channel Bandwidth

Test result: Pass

7.1 Limit

- Occupied channel Bandwidth shall fall within the band 2400-2483.50MHz.
- For non-adaptive non-FHSS equipment with e.i.r.p. greater than 10 dBm, the Occupied Channel Bandwidth shall be equal to or less than 20 MHz.

7.2 Block Diagram of Test Setup

7.2.1 For conducted method

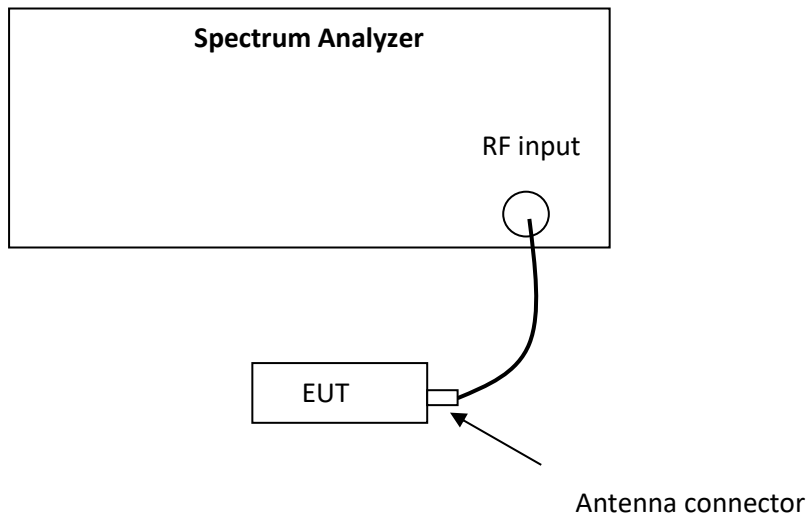

7.2.2 For radiated method

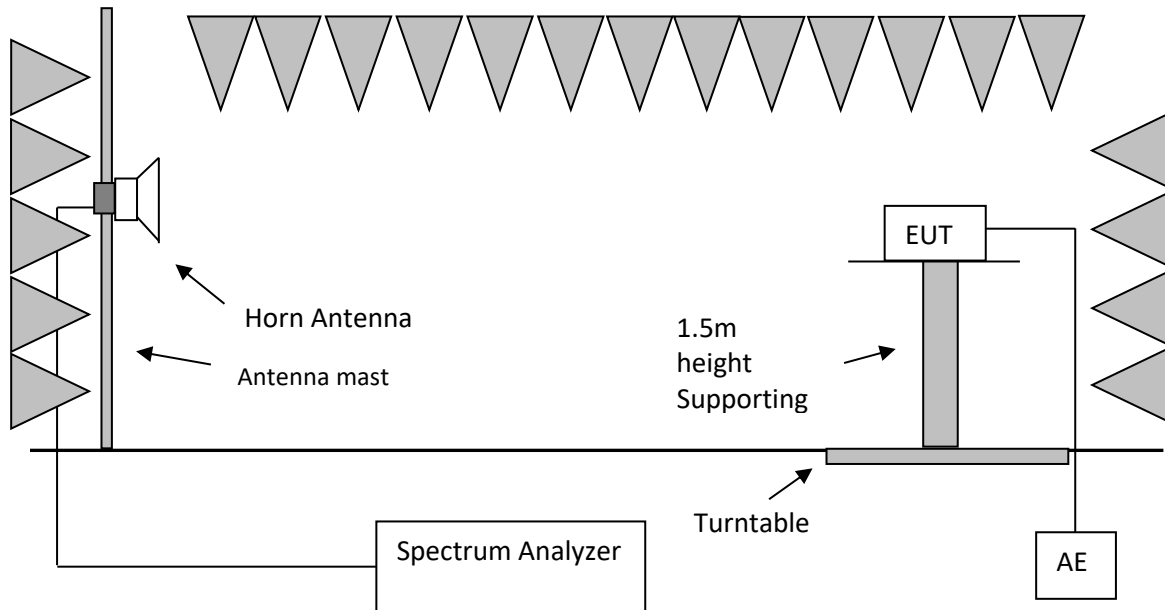

7.3 Test Conditions and Test Method

These measurements shall only be performed at normal test conditions.

In case of conducted measurements on smart antenna systems (equipment with multiple transmit chains) measurements need only to be performed on one of the active transmit chains (antenna outputs).

For FHSS equipment having overlapping channels, special software might be required to force the UUT to hop or transmit on a single Hopping Frequency.

The measurement shall be performed only on the lowest and the highest frequency within the stated frequency range. The frequencies on which the tests were performed shall be recorded.

If the equipment can operate with different Nominal Channel Bandwidths (e.g. 20 MHz and 40 MHz), then each channel bandwidth shall be tested separately.

For conducted method

The EUT was connected to the spectrum analyzer directly. Please refer to EN 300 328 Clause 5.4.7.2.1 for test method.

For radiated method

The measurement was applied in a semi-anechoic chamber. Please refer to EN 300 328 Clause 5.4.7.2.2 and for test method.

7.4 Test Result

Mode	Channel	99% Bandwidth (MHz)	F _L at 99% BW (MHz)	F _H at 99% BW (MHz)	Limit (MHz)	Pass/Fail
Zigbee	L	2.1572	2403.8459	2406.0031	2400 to 2483.5	Pass
	H	2.1648	2473.8413	2476.0061		Pass

Test Graphs



8 Transmitter unwanted emissions in the out-of-band domain

Test result: Pass

8.1 Limit

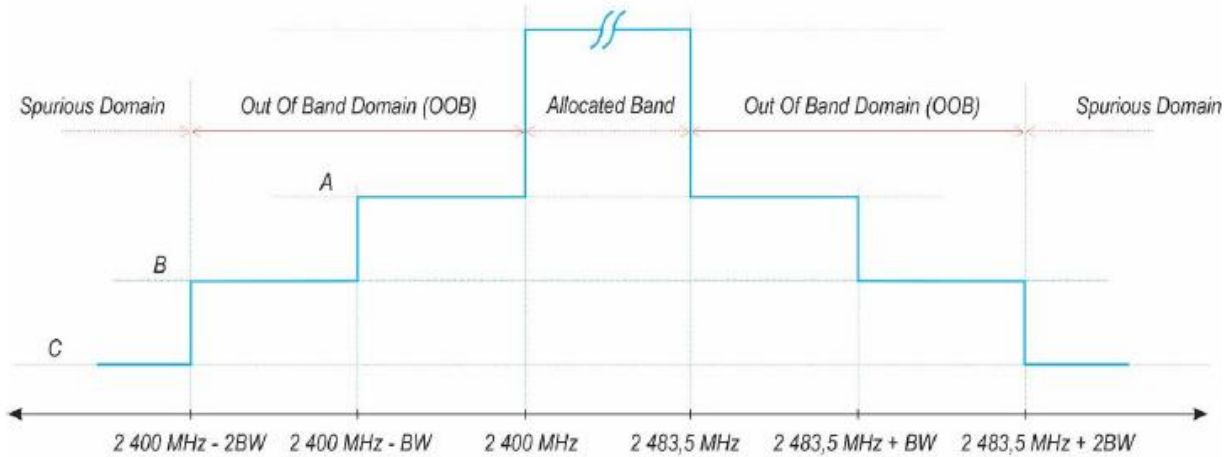

A: -10 dBm/MHz e.i.r.p.
B: -20 dBm/MHz e.i.r.p.
C: Spurious Domain limits

BW = Occupied Channel Bandwidth in MHz or 1 MHz whichever is greater

8.2 Block Diagram of Test Setup

8.2.1 For conducted method

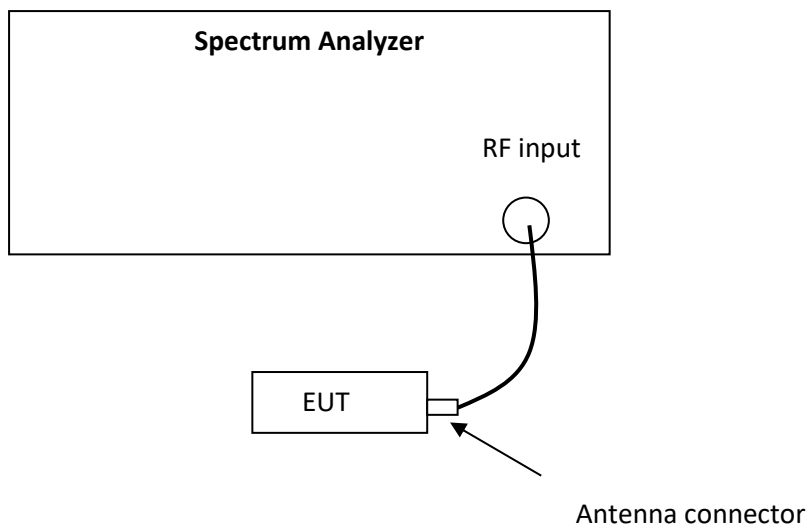

8.2.2 For radiated method

Step one

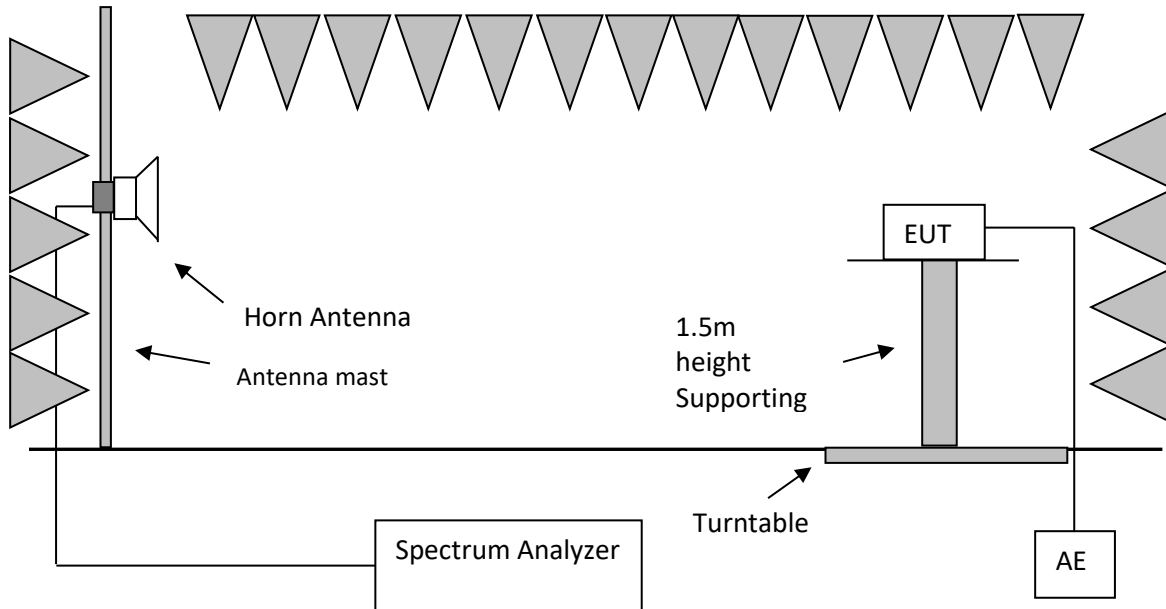

Step two

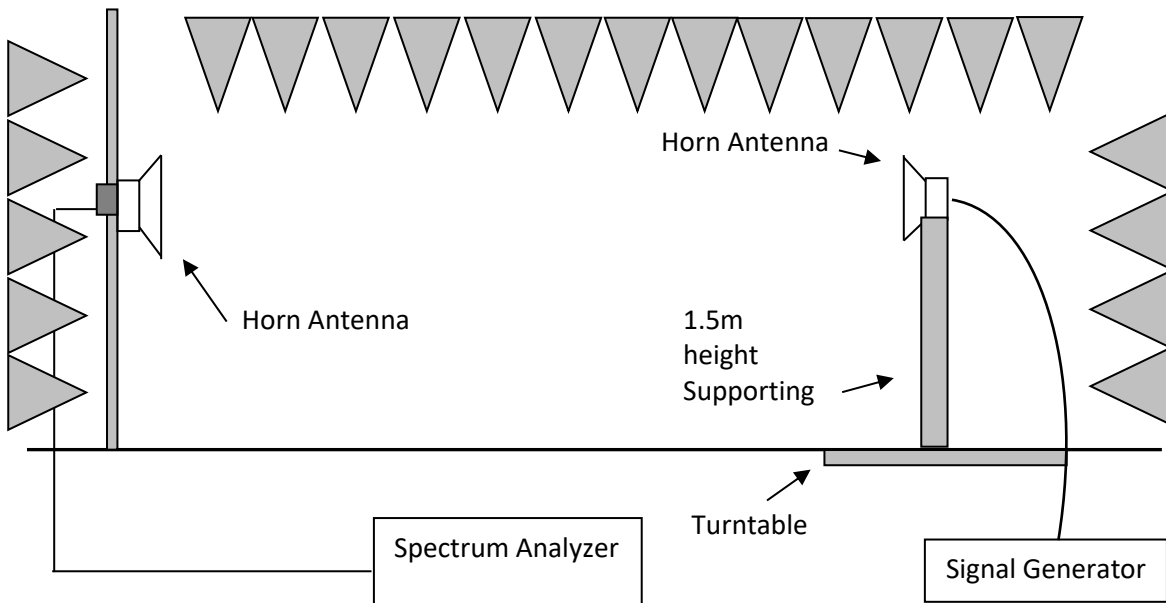

8.3 Test Conditions and Test Method

These measurements shall only be performed at normal test conditions.

For FHSS equipment, the measurements shall be performed during normal operation (hopping).

For non-FHSS equipment, the measurement shall be performed at the lowest and the highest channel on which the equipment can operate. These operating channels shall be recorded.

The equipment shall be configured to operate under its worst case situation with respect to output power.

If the equipment can operate with different Nominal Channel Bandwidths (e.g. 20 MHz and 40 MHz), then each channel bandwidth shall be tested separately.

For conducted method

The EUT was connected to the spectrum analyzer directly. Please refer to EN 300 328 Clause 5.4.8.2.1 for test method.

For radiated method

The measurement was applied in a semi-anechoic chamber. Please refer to EN 300 328 Clause 5.4.8.2.2 for test method.

8.4 Test Result

Mode	Channel	Out-of-band emission			
		Test Frequency (MHz)	OOB Emission (dBm/MHz)	Limit (dBm/MHz)	Pass/Fail
Zigbee	L	2400-BW ~ 2400	-56.36	-10	Pass
		2400-2BW ~ 2400-BW	-59.12	-20	Pass
	H	2483.5 ~ 2483.5+BW	-59.68	-10	Pass
		2483.5+BW ~ 2483.5+2*BW	-60.36	-20	Pass

Test Graphs

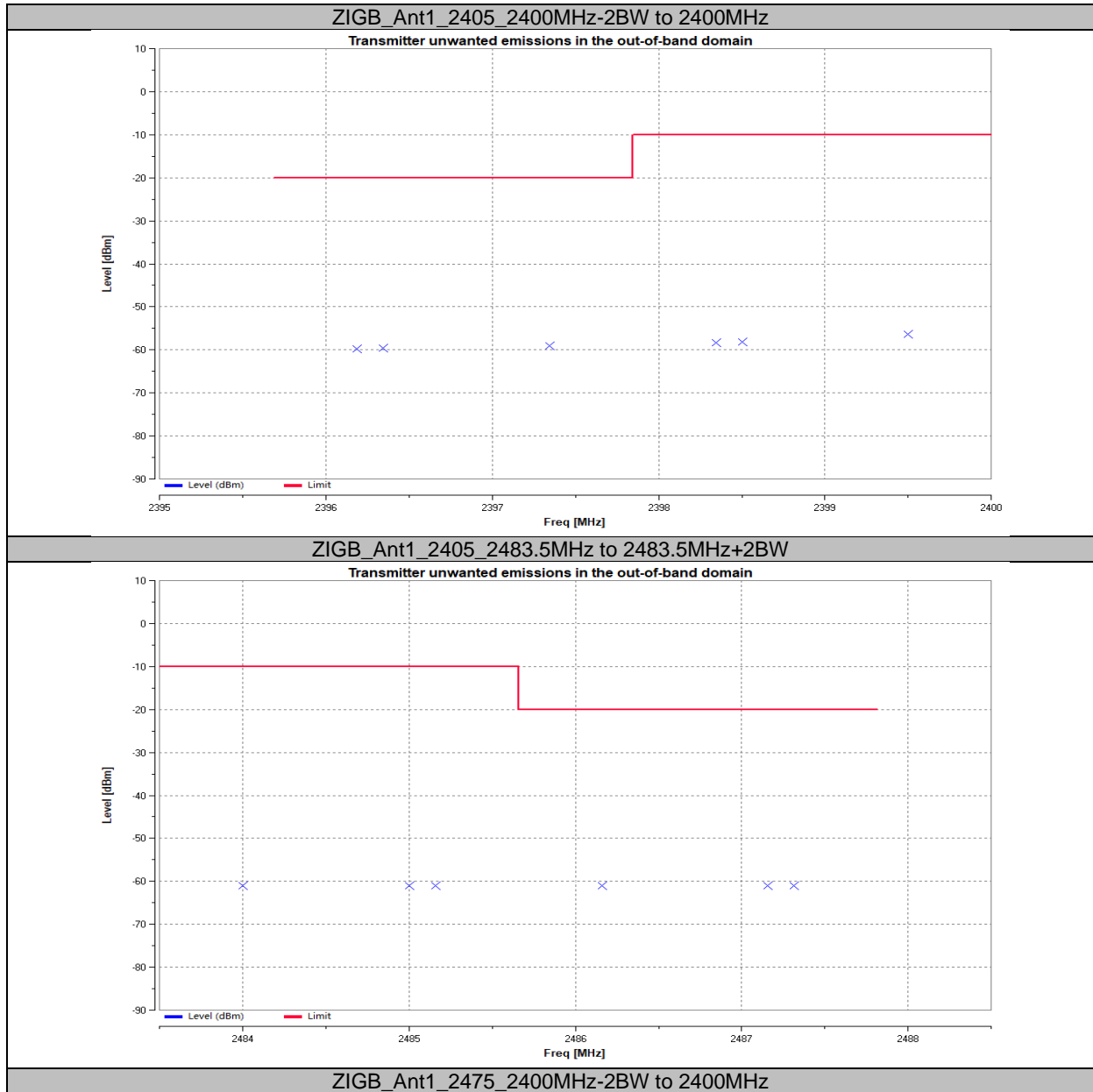

TEST REPORT

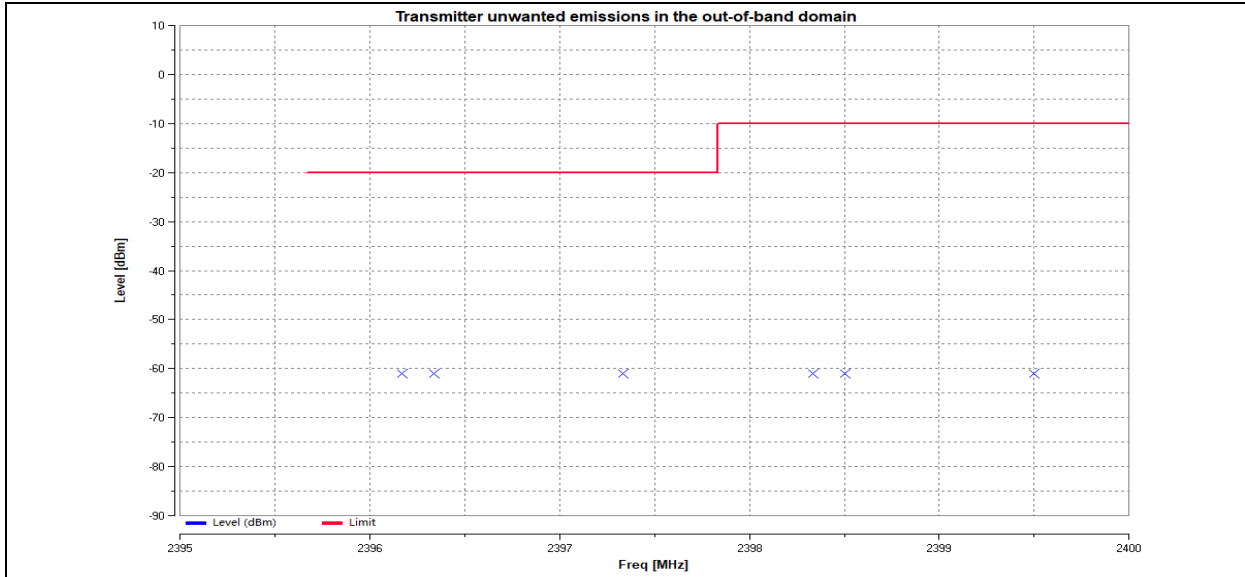

ZIGB_Ant1_2475_2483.5MHz to 2483.5MHz+2BW

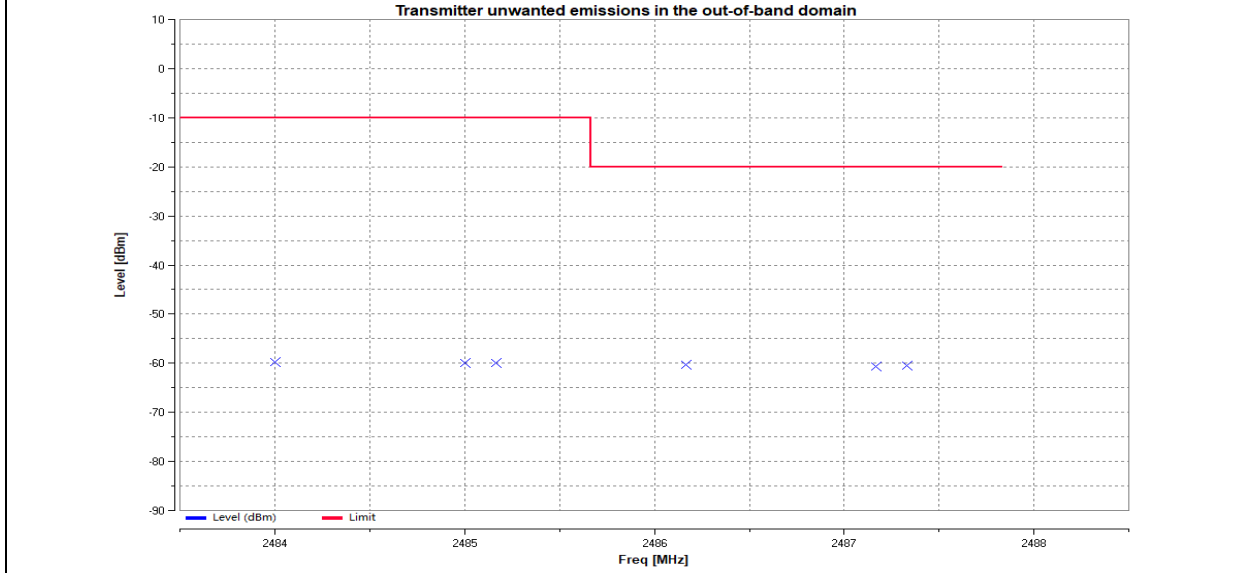

9 Transmitter unwanted emissions in the spurious domain

Test result: Pass

9.1 Limit

Frequency range	Maximum power, e.r.p. (≤ 1 GHz) e.i.r.p. (> 1 GHz)	Bandwidth
30 MHz to 47 MHz	-36 dBm	100 kHz
47MHz to 74MHz	-54 dBm	100 kHz
74 MHz to 87,5 MHz	-36 dBm	100 kHz
87,5 MHz to 118 MHz	-54 dBm	100 kHz
118 MHz to 174 MHz	-36 dBm	100 kHz
174 MHz to 230 MHz	-54 dBm	100 kHz
230 MHz to 470 MHz	-36 dBm	100 kHz
470 MHz to 694 MHz	-54 dBm	100 kHz
694 MHz to 1 GHz	-36 dBm	100 kHz
1 GHz to 12,75 GHz	-30 dBm	1 MHz

9.2 Block Diagram of Test Setup

9.2.1 For conducted method

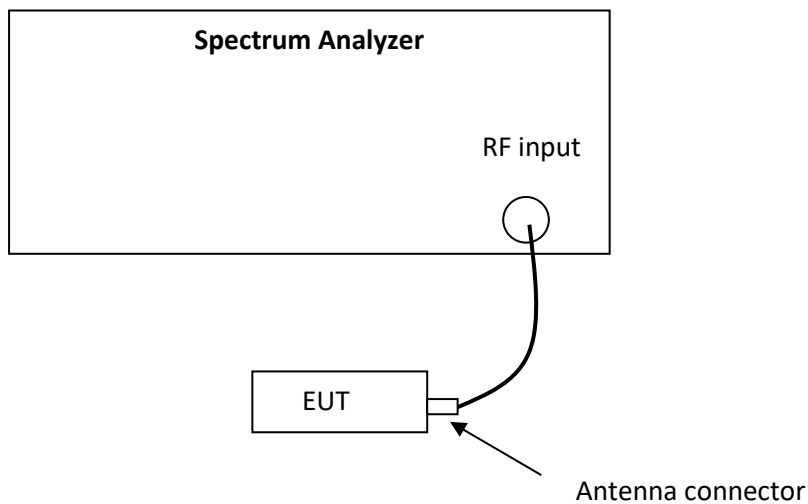

9.2.2 For radiated method

Step one

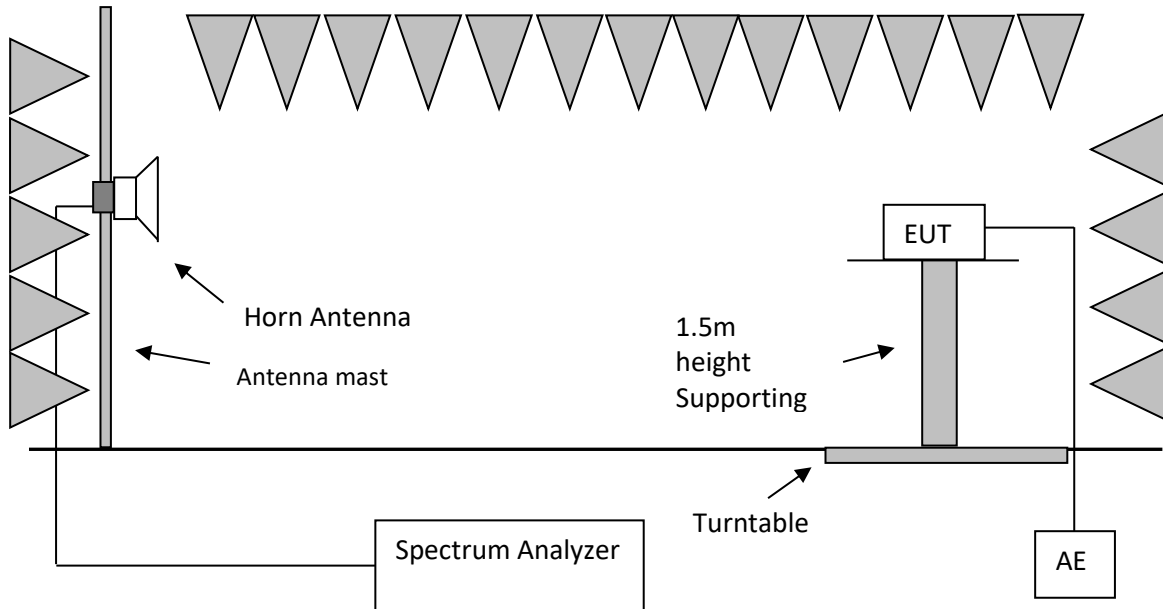

Step two

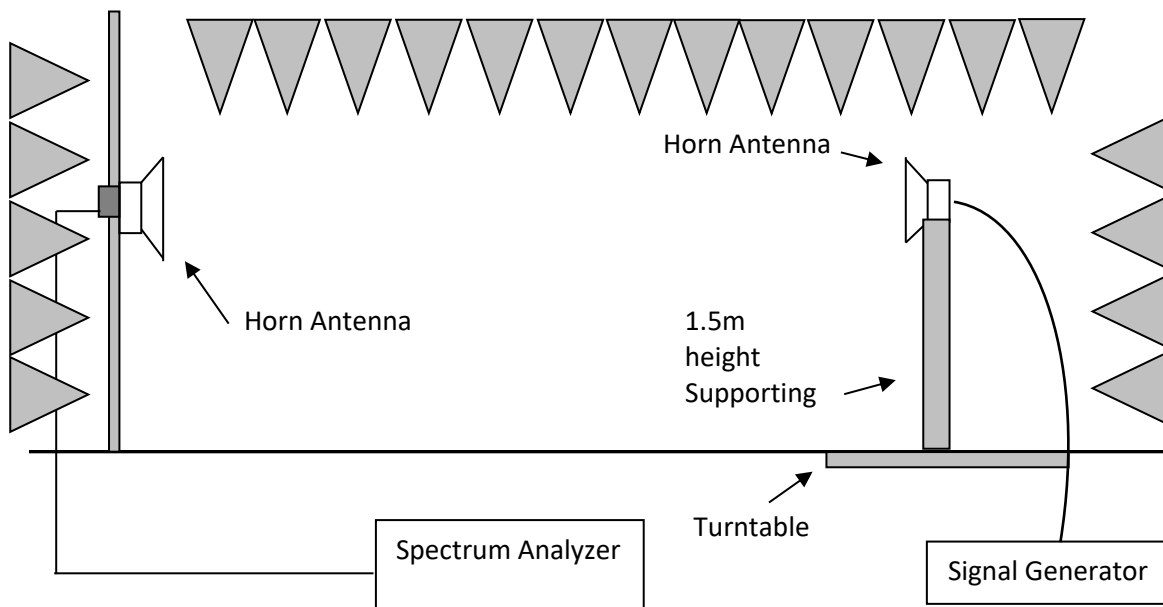

Note: for frequency lower than the 1GHz, the horn antennas among the two block diagrams above should be replaced with dipole antennas (or other antennas provided they can be referenced to a dipole).

9.3 Test Conditions and Test Method

These measurements shall only be performed at normal test conditions.

For FHSS equipment, the measurements may be performed when normal hopping is disabled. In this case measurements need to be performed when operating at the lowest and the highest hopping frequency. When this is not possible, the measurement shall be performed during normal operation (hopping).

For non-FHSS equipment, the measurement shall be performed at the lowest and the highest channel on which the equipment can operate. These operating channels shall be recorded.

The equipment shall be configured to operate under its worst case situation with respect to output power.

If the equipment can operate with different Nominal Channel Bandwidths (e.g. 20 MHz and 40 MHz), then the equipment shall be configured to operate under its worst case situation with respect to spurious emissions.

For conducted method

The EUT was connected to the spectrum analyzer directly. Please refer to EN 300 328 Clause 5.4.9.2.1 for test method.

For radiated method

The measurement was applied in a semi-anechoic chamber. Please refer to EN 300 328 Clause 5.4.9.2.2 for test method.

9.4 Test Result

Channel	Frequency (MHz)	Measured Level (dBm)	Limit (dBm)	Antenna Polarization	Pass/Fail
L	505.99	-61.18	-54.00	H	Pass
	4808.79	-42.49	-30.00	V	Pass
	10380.22	-43.76	-30.00	H	Pass
H	504.22	-60.90	-54.00	H	Pass
	5123.64	-40.15	-30.00	V	Pass
	12054.5	-42.75	-30.00	H	Pass

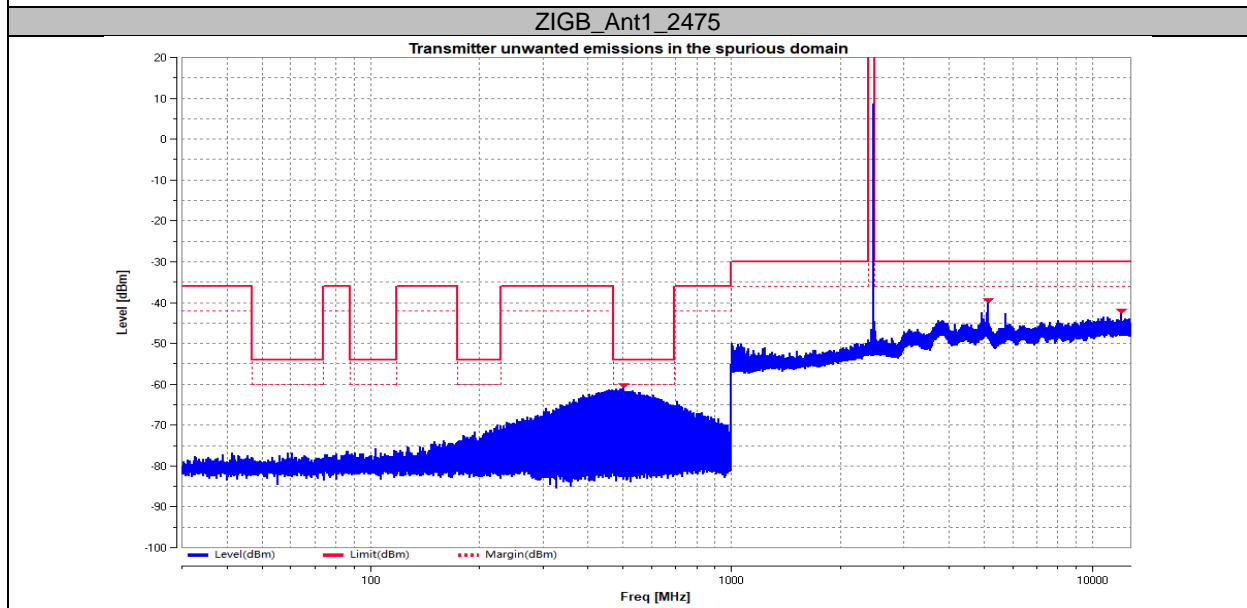
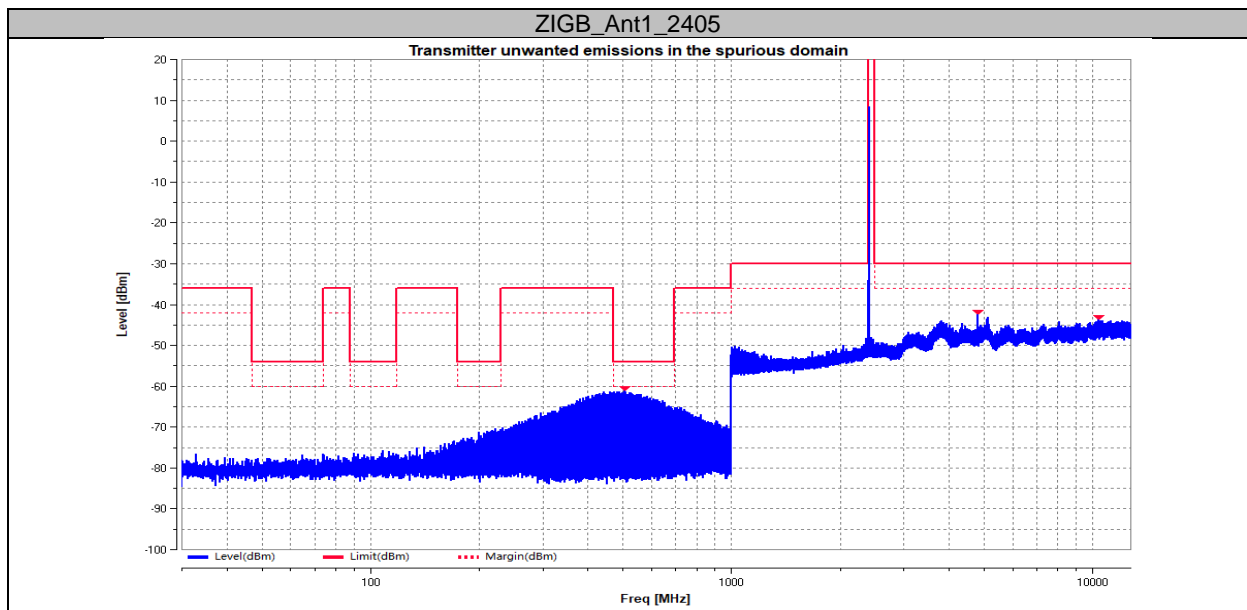

10 Adaptivity (non-FHSS)

Result: NA

10.1 Limit

- For non-FHSS equipment using DAA mechanism, please refer to EN 300 328 clause 4.3.2.6.2;
- For Frame Based Equipment, please refer to EN 300 328 clause 4.3.2.6.3.2.2;
- For Load Based Equipment, please refer to EN 300 328 clause 4.3.2.6.3.2.3;
- For Short Control Signaling Transmissions, please refer to EN 300 328 clause 4.3.2.6.4

Unwanted signal parameters			
Equipment Type	Wanted signal mean power from companion device (dBm)	Unwanted signal frequency (MHz)	Unwanted CW signal power (dBm)
DAA	-30 (see note 2)	2395 or 2488,5 (see note 1)	-35 (see note 2)

NOTE 1: The highest frequency shall be used for testing operating channels within the range 2 400 MHz to 2 442 MHz, while the lowest frequency shall be used for testing operating channels within the range 2 442 MHz to 2 483,5 MHz.

NOTE 2: The level specified is the level at the UUT receiver input assuming a 0 dBi antenna assembly gain. In case of conducted measurements, this level has to be corrected for the (in-band) antenna assembly gain (G). In case of radiated measurements, this level is equivalent to a power flux density in front of the UUT antenna.

Unwanted signal parameters			
Equipment Type	Wanted signal mean power from companion device	Unwanted signal frequency (MHz)	Unwanted CW signal power (dBm)
LBT	sufficient to maintain the link (see note 2)	2395 or 2488,5 (see note 1)	-35 (see note 3)

NOTE 1: The highest frequency shall be used for testing operating channels within the range 2 400 MHz to 2 442 MHz, while the lowest frequency shall be used for testing operating channels within the range 2 442 MHz to 2 483,5 MHz.

NOTE 2: A typical conducted value which can be used in most cases is -50 dBm/MHz.

NOTE 3: The level specified is the level at the UUT receiver input assuming a 0 dBi antenna assembly gain. In case of conducted measurements, this level has to be corrected for the (in-band) antenna assembly gain (G). In case of radiated measurements, this level is equivalent to a power flux density in front of the UUT antenna.

10.2 Block Diagram of Test Setup

10.2.1 For conducted method

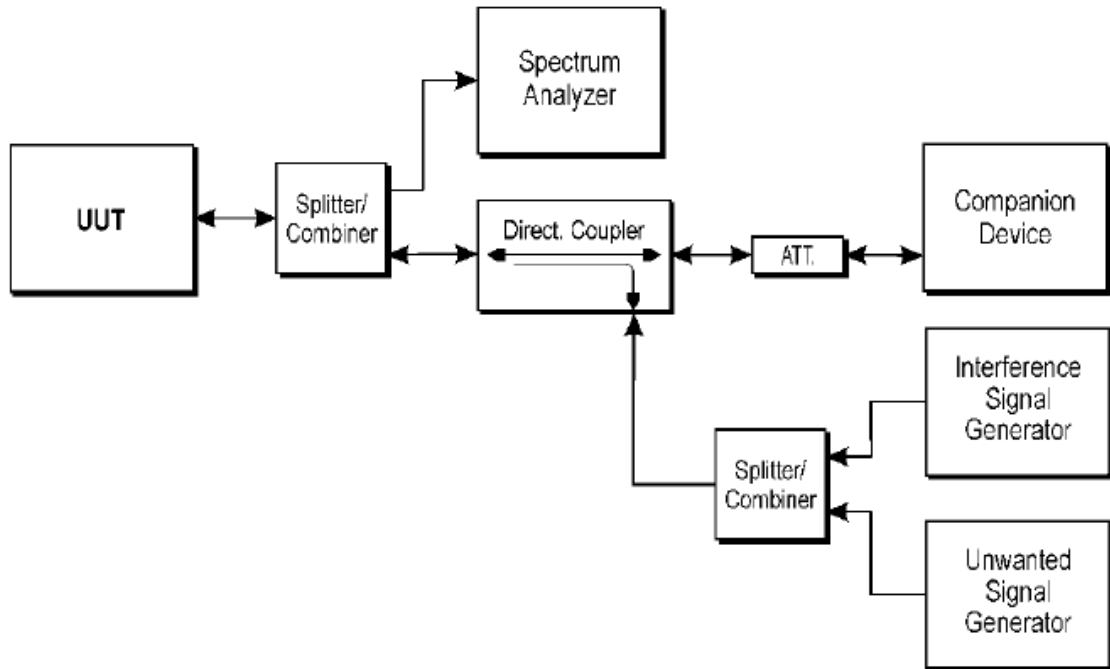

10.2.2 For radiated method

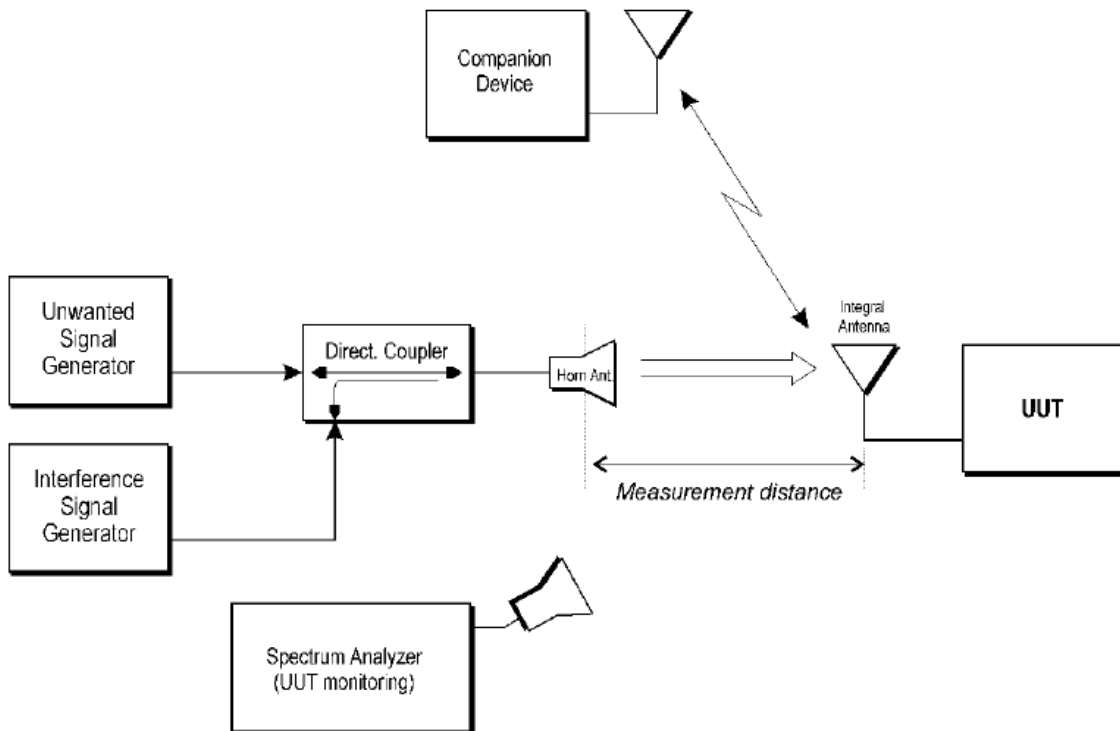

10.3 Test Conditions and Test Method

These measurements shall only be performed at normal test conditions.

When supported by the operating frequency range of the equipment, this test shall be performed on two operating (hopping) frequencies randomly selected from the operating frequencies used by the equipment. The first (lower) frequency shall be randomly selected within the range 2 400 MHz to 2 442 MHz while the second (higher) frequency shall be randomly selected within the range 2 442 MHz to 2 483,5 MHz. The equipment shall be in a normal operating (hopping) mode. In case of FHSS equipment, it shall be ensured that none of the test frequencies are blacklisted, otherwise another test frequency shall be selected.

For equipment which can operate in an adaptive and a non-adaptive mode, it shall be verified that prior to the test, the equipment is operating in the adaptive mode.

The equipment shall be configured in a mode that results in the longest Channel Occupancy Time.

For conducted method

The EUT was connected to the spectrum analyzer directly. Please refer to EN 300 328 Clause 5.4.6.2.1 for test method.

For radiated method

The measurement was applied in a semi-anechoic chamber. Please refer to EN 300 328 Clause 5.4.6.2.2 for test method.

10.4 Test Result

None

11 Receiver Blocking

Result: Pass

11.1 Limit

Receiver Category 1 Equipment			
Wanted signal mean power from companion device (dBm) (see notes 1 and 4)	Blocking Signal Frequency (MHz)	Blocking Signal Power (dBm) (See note 4)	Type of blocking signal
(-133 dBm + 10 × log ₁₀ (OCBW)) or -68 dBm whichever is less (see note 2)	2 380	-34	CW
	2 504		
(-139 dBm + 10 × log ₁₀ (OCBW)) or -74 dBm whichever is less (see note 3)	2 300		
	2 330		
	2 360		
	2 524		
	2 584		
	2 674		

NOTE 1: OCBW is in Hz.

NOTE 2: In case of radiated measurements using a companion device and the level of the wanted signal from the companion device cannot be determined, a relative test may be performed using a wanted signal up to P_{min} + 26 dB where P_{min} is the minimum level of wanted signal required to meet the minimum performance criteria as defined in clause 4.3.1.12.3 in the absence of any blocking signal.

NOTE 3: In case of radiated measurements using a companion device and the level of the wanted signal from the companion device cannot be determined, a relative test may be performed using a wanted signal up to P_{min} + 20 dB where P_{min} is the minimum level of wanted signal required to meet the minimum performance criteria as defined in clause 4.3.1.12.3 in the absence of any blocking signal.

NOTE 4: The level specified is the level at the UUT receiver input assuming a 0 dBi antenna assembly gain. In case of conducted measurements, this level has to be corrected for the (in-band) antenna assembly gain (G). In case of radiated measurements, this level is equivalent to a power flux density (PFD) in front of the UUT antenna with the UUT being configured/positioned as recorded in clause 5.4.3.2.2.

Receiver Category 2 Equipment			
Wanted signal mean power from companion device (dBm) (see notes 1 and 3)	Blocking Signal Frequency (MHz)	Blocking Signal Power (dBm) (See note 3)	Type of blocking signal
(-139 dBm + 10 × log ₁₀ (OCBW) + 10 dB) or (-74 dBm + 10 dB) whichever is less (see note 2)	2 380	-34	CW
	2 504		
	2 300		
	2 584		
<p>NOTE 1: OCBW is in Hz.</p> <p>NOTE 2: In case of radiated measurements using a companion device and the level of the wanted signal from the companion device cannot be determined, a relative test may be performed using a wanted signal up to P_{min} + 26 dB where P_{min} is the minimum level of wanted signal required to meet the minimum performance criteria as defined in clause 4.3.1.12.3 in the absence of any blocking signal.</p> <p>NOTE 3: The level specified is the level at the UUT receiver input assuming a 0 dBi antenna assembly gain. In case of conducted measurements, this level has to be corrected for the (in-band) antenna assembly gain (G). In case of radiated measurements, this level is equivalent to a power flux density (PFD) in front of the UUT antenna with the UUT being configured/positioned as recorded in clause 5.4.3.2.2.</p>			

Receiver Category 3 Equipment			
Wanted signal mean power from companion device (dBm) (see notes 1 and 3)	Blocking Signal Frequency (MHz)	Blocking Signal Power (dBm) (See note 3)	Type of blocking signal
(-139 dBm + 10 × log ₁₀ (OCBW) + 20 dB) or (-74 dBm + 20 dB) whichever is less (see note 2)	2 380	-34	CW
	2 504		
	2 300		
	2 584		
<p>NOTE 1: OCBW is in Hz.</p> <p>NOTE 2: In case of radiated measurements using a companion device and the level of the wanted signal from the companion device cannot be determined, a relative test may be performed using a wanted signal up to P_{min} + 30 dB where P_{min} is the minimum level of wanted signal required to meet the minimum performance criteria as defined in clause 4.3.1.12.3 in the absence of any blocking signal.</p> <p>NOTE 3: The level specified is the level at the UUT receiver input assuming a 0 dBi antenna assembly gain. In case of conducted measurements, this level has to be corrected for the (in-band) antenna assembly gain (G). In case of radiated measurements, this level is equivalent to a power flux density (PFD) in front of the UUT antenna with the UUT being configured/positioned as recorded in clause 5.4.3.2.2.</p>			

11.2 Block Diagram of Test Setup

11.2.1 For conducted method

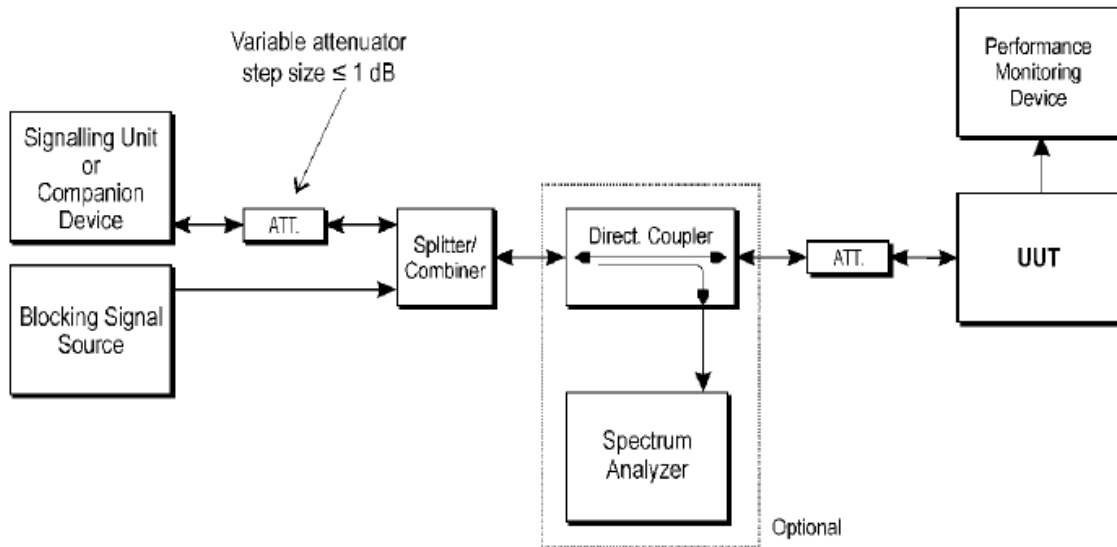

11.2.2 For radiated method

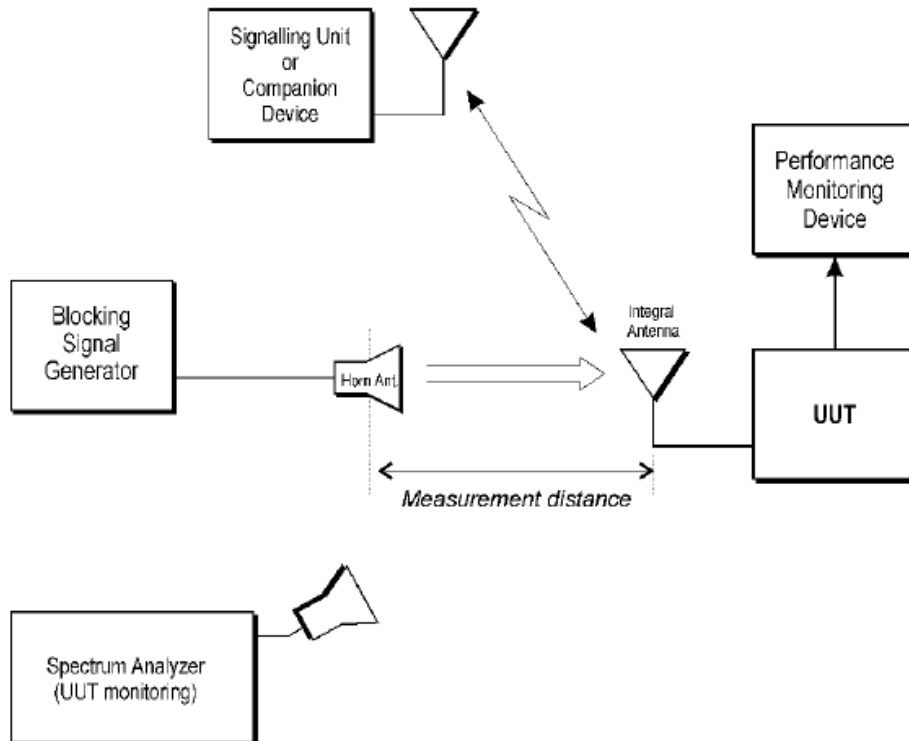

11.3 Test Conditions and Test Method

These measurements shall only be performed at normal test conditions.

For non-FHSS equipment, having more than one operating channel, the operating channels on which the testing has to be performed shall be selected as follows:

- For testing blocking frequencies less than 2 400 MHz, the equipment shall operate on the lowest operating channel.
- For testing blocking frequencies greater than 2 500 MHz, the equipment shall operate on the highest operating channel.

Equipment which can change their operating channel automatically (adaptive channel allocation), and where this function cannot be disabled, shall be tested as a FHSS equipment.

If the equipment can be configured to operate with different Nominal Channel Bandwidths (e.g. 20 MHz and 40 MHz) and different data rates, then the combination of the smallest channel bandwidth and the lowest data rate for this channel bandwidth which still allows the equipment to operate as intended shall be used. This mode of operation shall be aligned with the performance criteria defined in clause 4.3.1.12.3 or clause 4.3.2.11.3 and shall be described in the test report.

For conducted method

The EUT was connected to the spectrum analyzer directly. Please refer to EN 300 328 Clause 5.4.11.2.1 for test method.

For radiated method

The measurement was applied in a semi-anechoic chamber. Please refer to EN 300 328 Clause 5.4.11.2.2 for test method.

11.4 Test Result

Mode	Channel	Wanted signal [dBm]	Freq. [MHz]	CW [dBm]	PER [%]	Limit [%]	Pass/Fail
Zigbee	L	-64.16	2300	-32.5	0.00	≤10	PASS
		-64.16	2380	-32.5	0.00	≤10	PASS
	H	-68.15	2504	-32.5	0.00	≤10	PASS
		-74.15	2524	-32.5	0.00	≤10	PASS
		-74.15	2584	-32.5	0.10	≤10	PASS
		-74.15	2674	-32.5	0.00	≤10	PASS

Note 1: OCBW is in Hz.

Note 2: The Performance Criteria is based on the PER less than or equal to 10 %.

Note 3: For the conducted measurements, blocking signal power = the actual blocking signal

Test Graphs

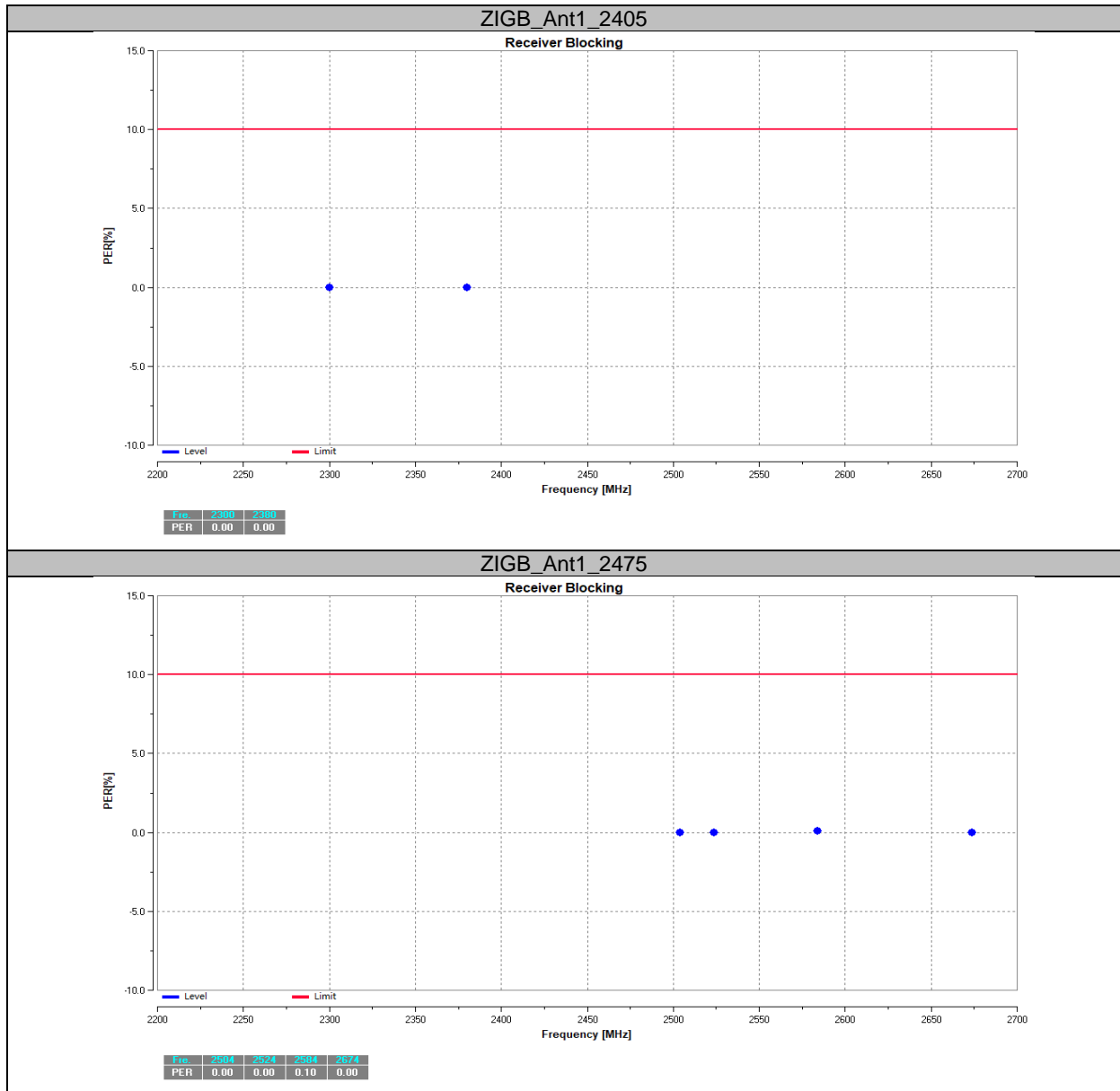

12 Receiver spurious emission

Test result: Pass

12.1 Limit

Frequency range	Maximum power, e.r.p. (≤ 1 GHz) e.i.r.p. (> 1 GHz)	Bandwidth
30 MHz to 1 GHz	-57 dBm	100 kHz
1 GHz to 12,75 GHz	-47 dBm	1 MHz

12.2 Block Diagram of Test Setup

12.2.1 For conducted method

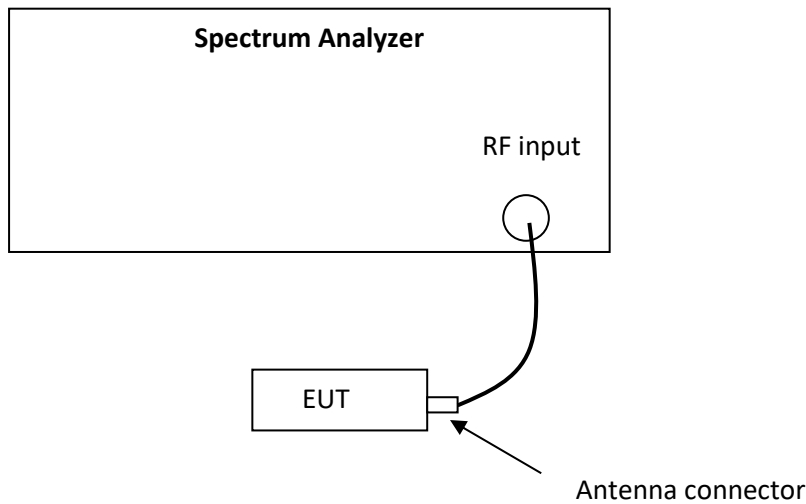

12.2.2 For radiated method

Step one

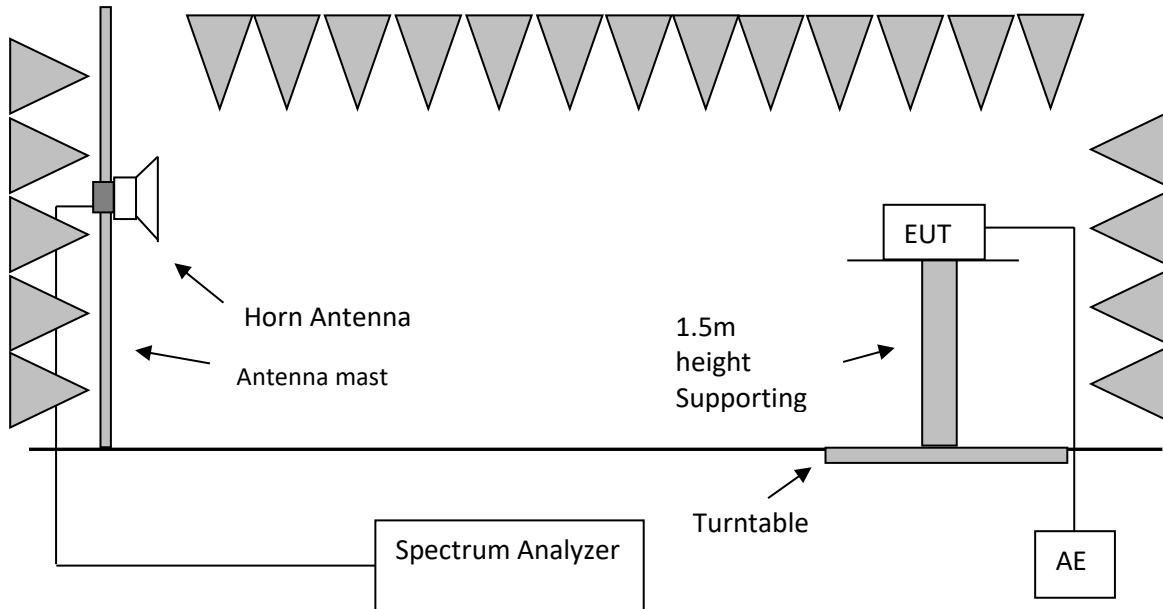

Step two

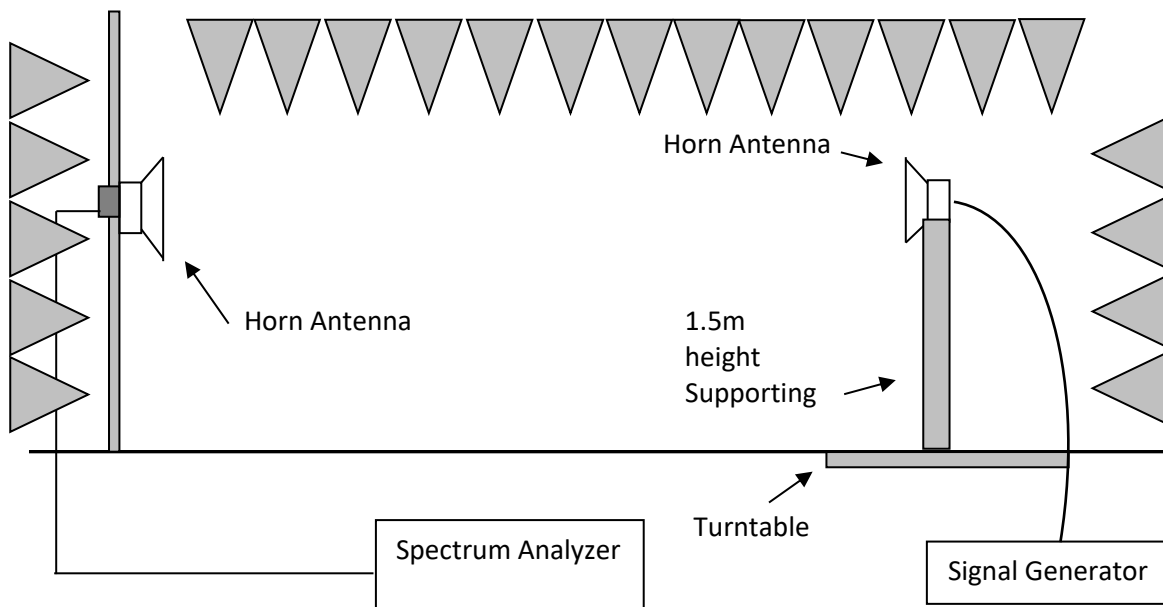

Note: for frequency lower than the 1GHz, the horn antennas among the two block diagrams above should be replaced with dipole antennas (or other antennas provided they can be referenced to a dipole).

12.3 Test Conditions and Test Method

These measurements shall only be performed at normal test conditions.

Testing shall be performed when the equipment is in a receive-only mode.

For non-FHSS equipment, the measurement shall be performed at the lowest and the highest channel on which the equipment can operate. These frequencies shall be recorded.

For FHSS equipment, the measurements may be performed when normal hopping is disabled. In this case measurements need to be performed when operating at the lowest and the highest hopping frequency. These frequencies shall be recorded. When disabling the normal hopping is not possible, the measurement shall be performed during normal operation (hopping).

For conducted method

The EUT was connected to the spectrum analyzer directly. Please refer to EN 300 328 Clause 5.4.10.2.1 for test procedure.

For radiated method

The measurement was applied in a semi-anechoic chamber. Please refer to EN 300 328 Clause 5.4.10.2.2 for test procedure.

12.4 Test protocol

Channel	Frequency (MHz)	Measured Level (dBm)	Limit (dBm)	Margin (dBm)	Antenna Polarization	Pass/Fail
L	≤ 1GHz	< -67.00	-57.00	>10	H	Pass
	≤ 1GHz	< -67.00	-57.00	>10	V	Pass
	> 1GHz	< -57.00	-47.00	>10	H	Pass
	> 1GHz	< -57.00	-47.00	>10	V	Pass
H	≤ 1GHz	< -67.00	-57.00	>10	H	Pass
	≤ 1GHz	< -67.00	-57.00	>10	V	Pass
	> 1GHz	< -57.00	-47.00	>10	H	Pass
	> 1GHz	< -57.00	-47.00	>10	V	Pass

Test Graphs

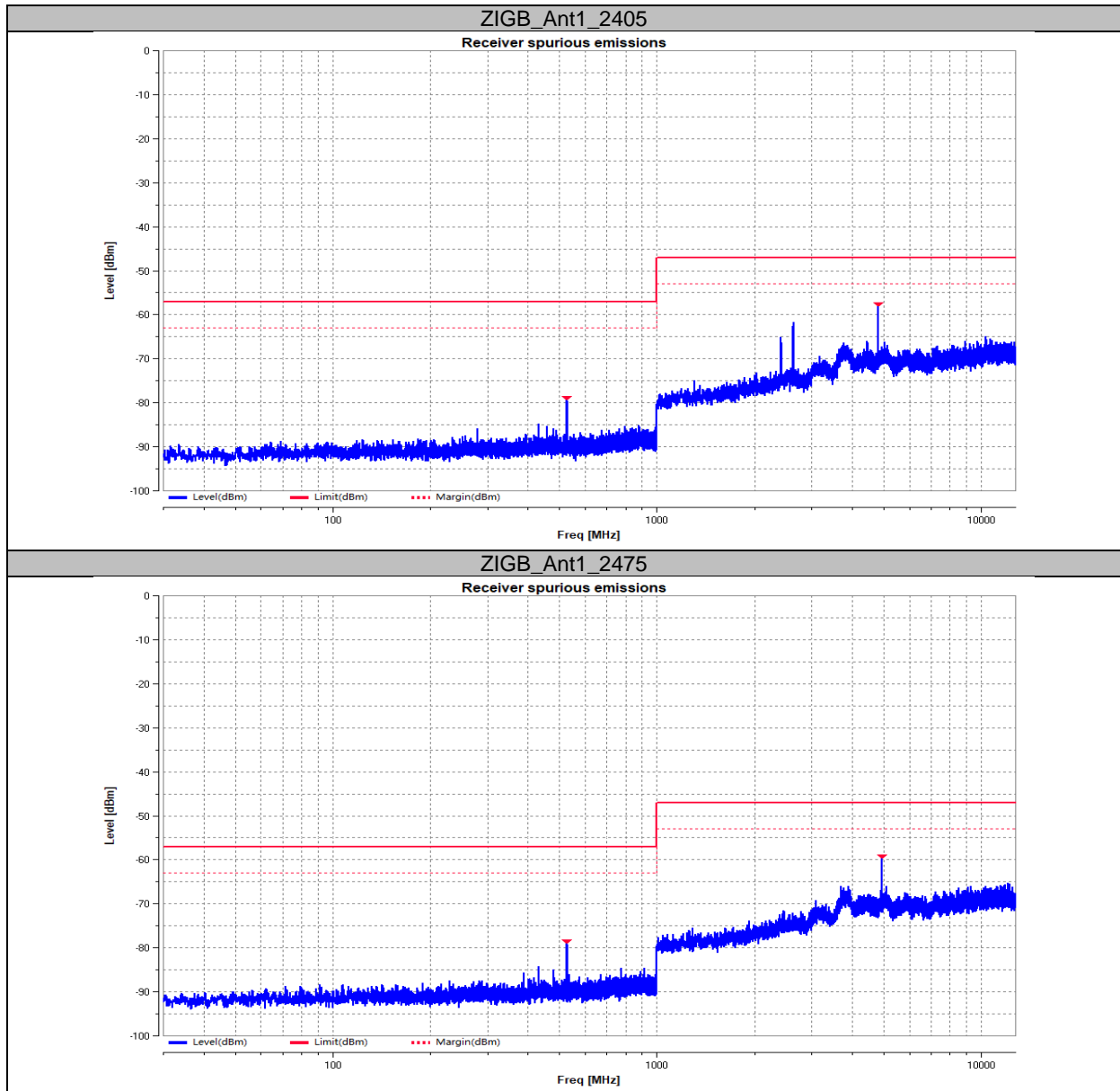

13 Geo-location capability

Test result: NA

13.1 Applicability

This requirement only applies to non-FHSS equipment with geo-location capability.

13.2 Requirements

The geographical location determined by the non-FHSS equipment shall not be accessible to the user in a way that would allow the user to alter it.

13.3 Description

This device doesn't support this capability declared by the manufacturer.

Appendix I: Photograph of equipment under test

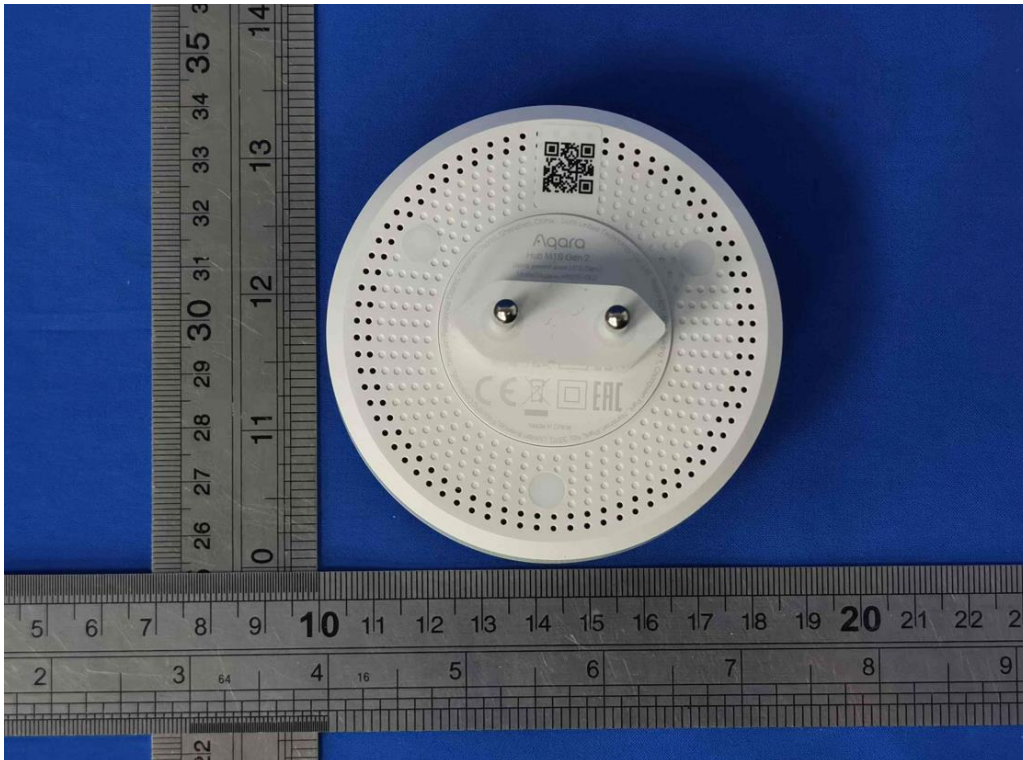
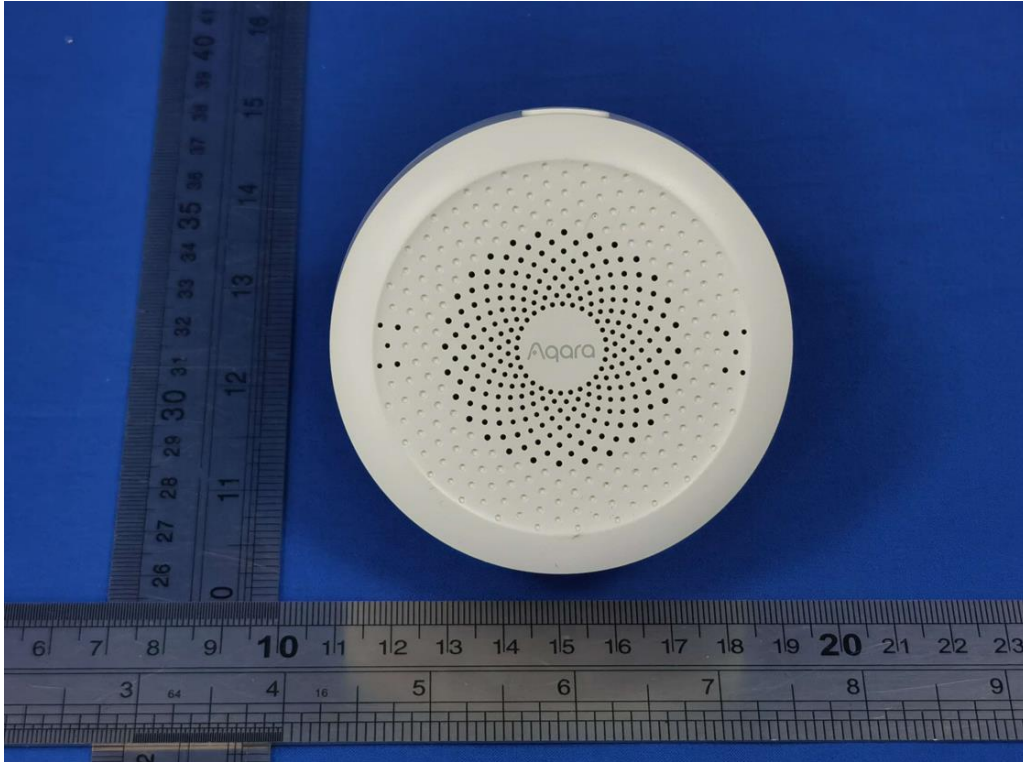

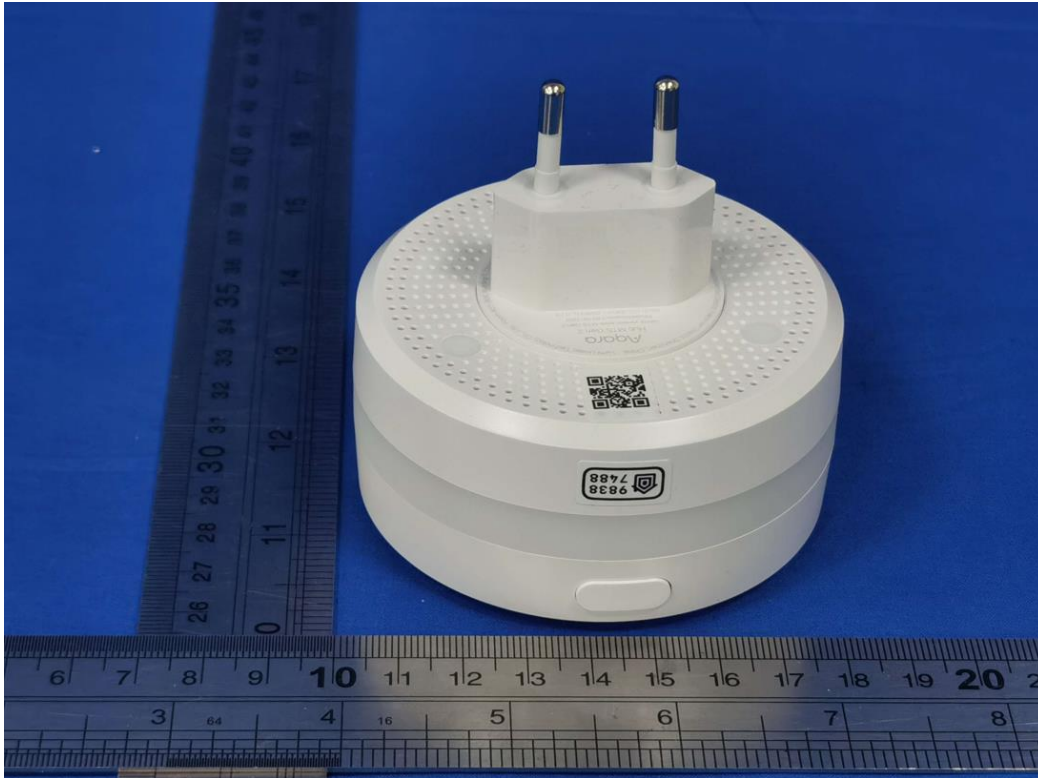

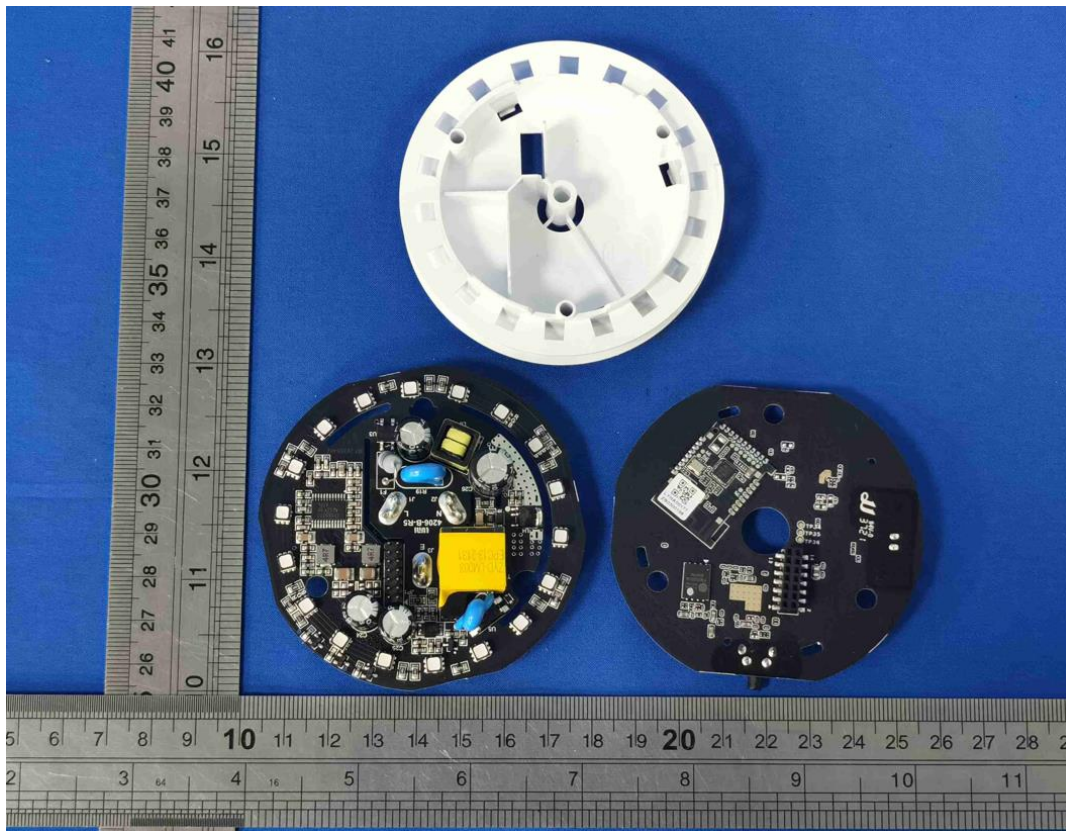

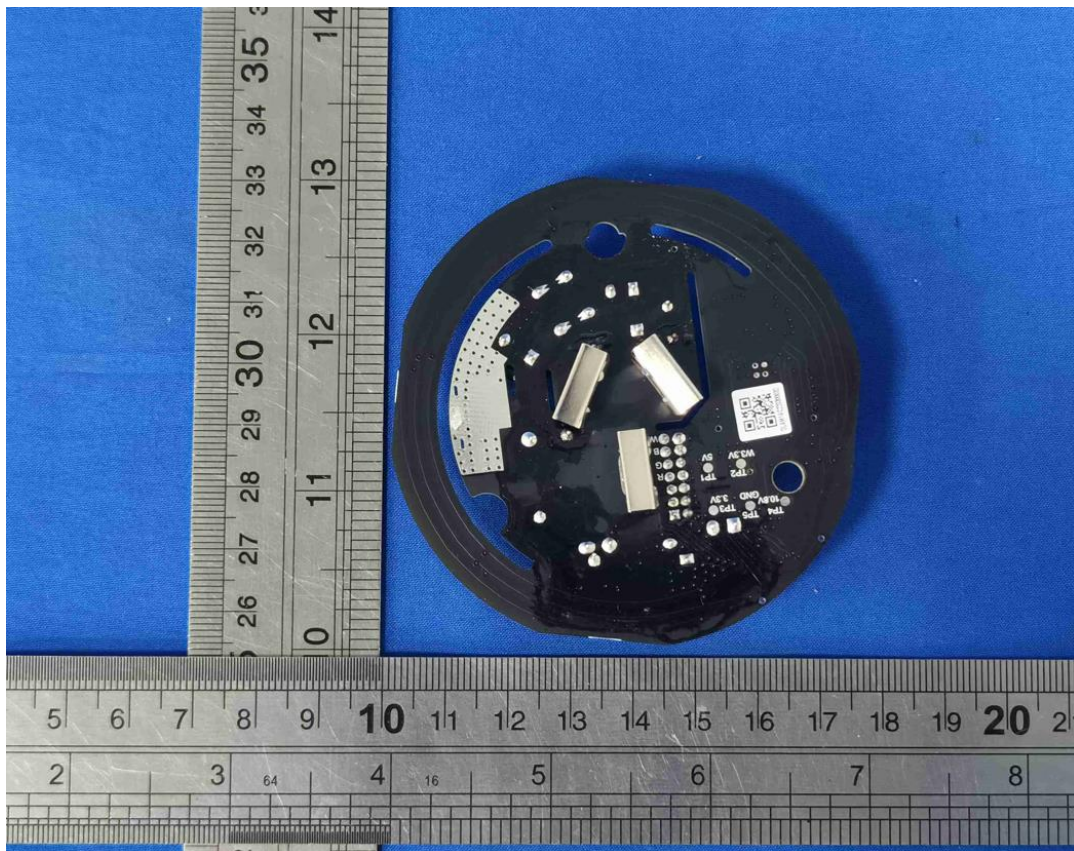
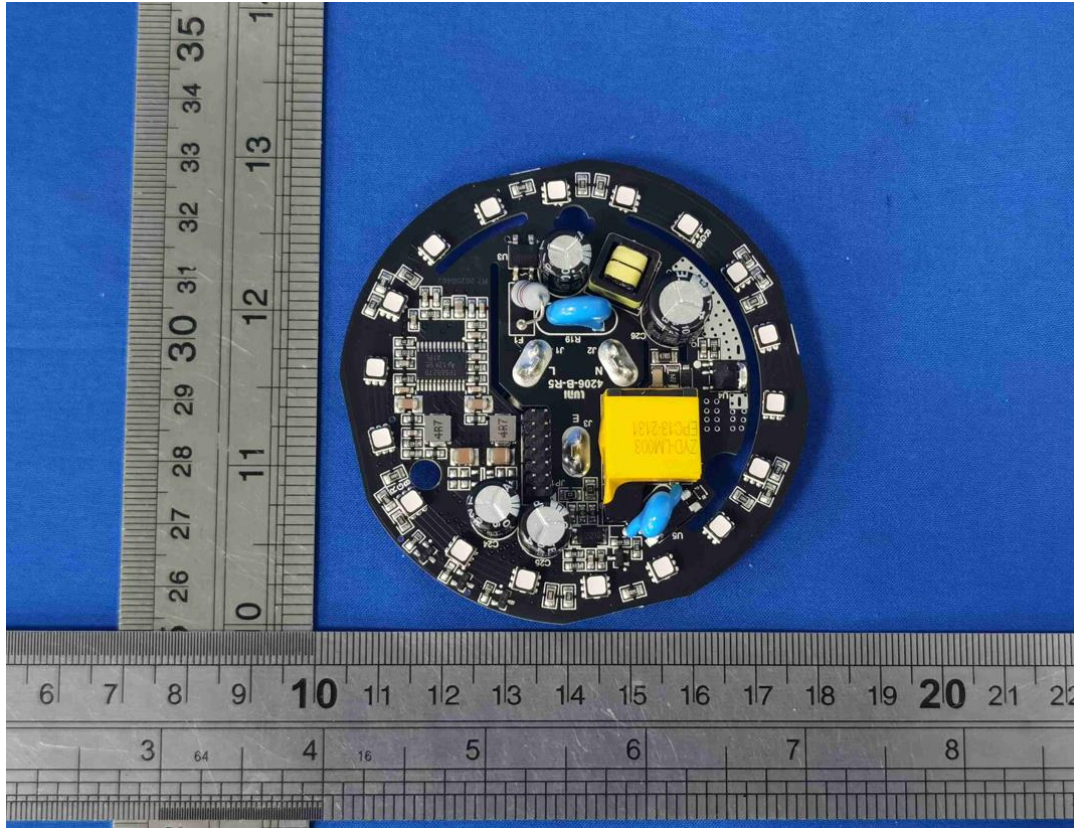

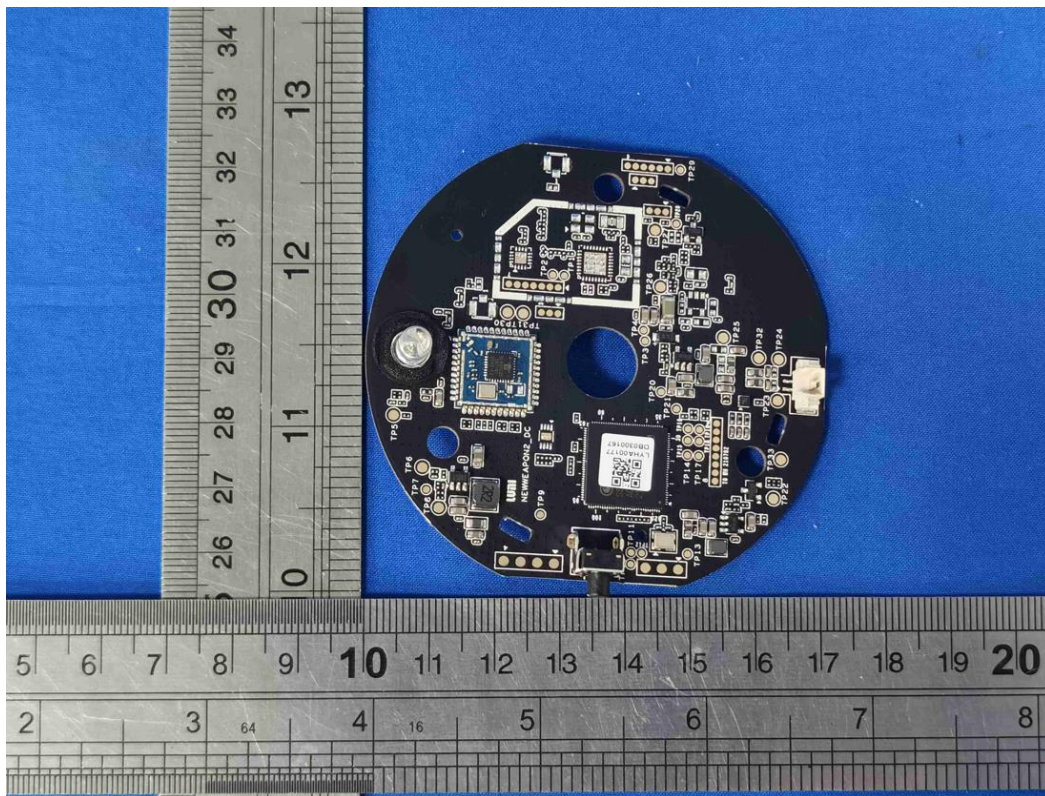
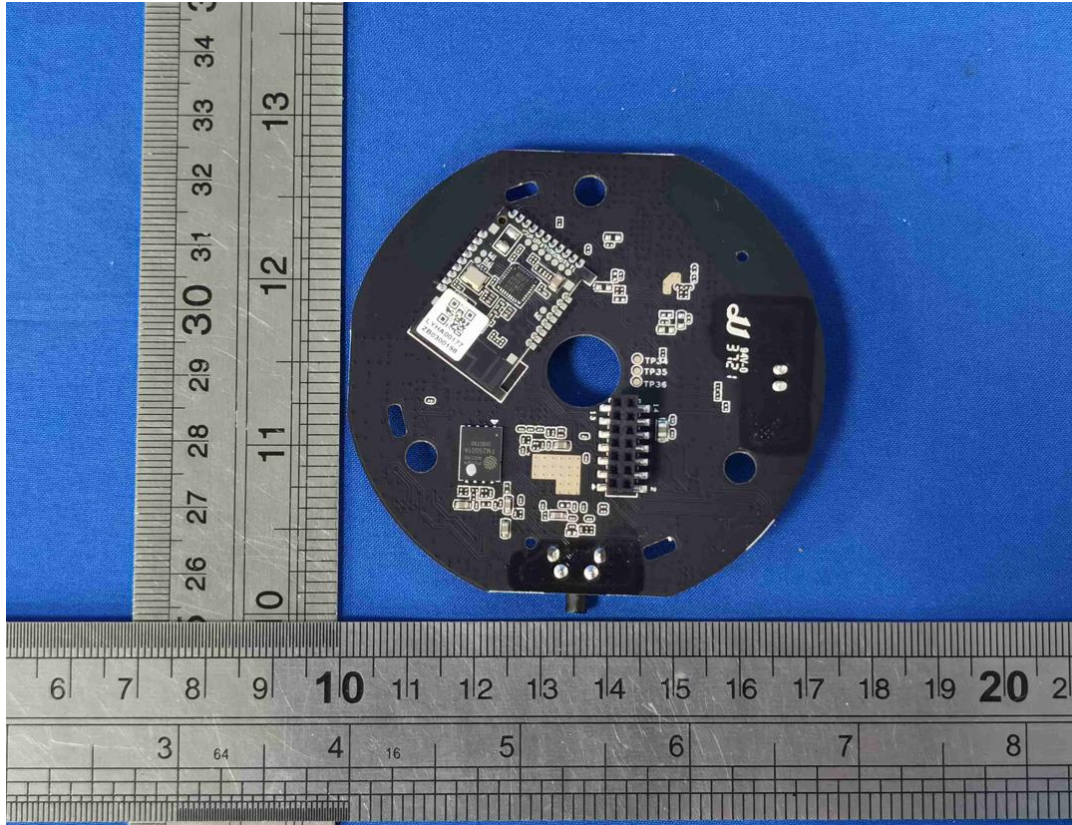

***** END *****