



TEST REPORT

Report No.: **CTC20201680E03**

Applicant.....: **Lumi United Technology Co., Ltd**

Address.....: 8th Floor, JinQi Wisdom Valley, No.1 Tangling Road, Liuxian Ave, Taoyuan Residential District, Nanshan District, Shenzhen,China

Manufacturer.....: Lumi United Technology Co., Ltd

Address.....: 8th Floor, JinQi Wisdom Valley, No.1 Tangling Road, Liuxian Ave, Taoyuan Residential District, Nanshan District, Shenzhen,China

Product Name.....: **TVOC Air Quality Monitor**

Trade Mark.....: Aqara

Model/Type reference.....: AAQS-S01

Listed Model(s): /

Standard.....: **ETSI EN 301 489-1 V2.2.3: 2019-11**
ETSI EN 301 489-17 V3.2.4: 2020-09

Date of receipt of test sample...: Nov. 09, 2020

Date of testing.....: Nov. 09, 2020 to Nov. 16, 2020

Date of issue.....: Mar. 09, 2021

Result.....: **PASS**

Compiled by:
(Printed name+signature) Lykan Cai

Supervised by:
(Printed name+signature) Eric Zhang

Approved by:
(Printed name+signature) Walter Chen



This test report may be duplicated completely for legal use with the approval of the applicant. It should not be reproduced except in full, without the written approval of our laboratory. The client should not use it to claim product endorsement by CTC. The test results in the report only apply to the tested sample. The test report shall be invalid without all the signatures of testing engineers, reviewer and approver. Any objections must be raised to CTC within 15 days since the date when the report is received. It will not be taken into consideration beyond this limit. The test report merely correspond to the test sample.



Table of Contents

1	TEST SUMMARY	3
1.1	TEST STANDARDS	3
1.2	REPORT VERSION	3
1.3	TEST DESCRIPTION	4
1.4	TEST FACILITY	5
1.5	MEASUREMENT UNCERTAINTY	5
1.6	ENVIRONMENTAL CONDITIONS	6
2	GENERAL INFORMATION.....	7
2.1	GENERAL DESCRIPTION OF EUT	7
2.2	ACCESSORY EQUIPMENT INFORMATION	8
2.3	DESCRIPTION OF TEST MODES	8
2.4	MEASUREMENT INSTRUMENTS LIST	9
3	EMC EMISSION TEST	10
3.1	RADIATED EMISSION MEASUREMENT	10
4	EMC IMMUNITY TEST	16
4.1	ELECTROSTATIC DISCHARGE	17
4.2	RADIO FREQUENCY ELECTROMAGNETIC FIELD.....	19
5	EUT TEST PHOTO.....	21
6	PHOTOGRAPHS OF EUT.....	23



1 TEST SUMMARY

1.1 Test standards

The tests were performed according to following standards:

[ETSI EN 301 489-1 V2.2.3 \(2019-11\)](#)—ElectroMagnetic Compatibility (EMC) standard for radio equipment and services; Part 1: Common technical requirements; Harmonised Standard for ElectroMagnetic Compatibility

[ETSI EN 301 489-17 V3.2.4 \(2020-09\)](#)—ElectroMagnetic Compatibility (EMC) standard for radio equipment and services; Part 17: Specific conditions for Broadband Data Transmission Systems; Harmonised Standard covering the essential requirements of article 3.1(b) of Directive 2014/53/EU

1.2 Report version

Revised No.	Date of issue	Description
01	Mar. 09, 2021	Original



1.3 Test description

Emission				
Test Item	Standard Requirement (ETSI EN301 489-1)	Result	Test Engineer	Remark
Radiated emission	Clause 8.2	Pass	Jason Chen	
Conducted Emission	Clause 8.4	N/A	N/A	
Harmonic current emissions	Clause 8.5	N/A	N/A	NOTE(2)
Voltage changes, voltage fluctuations and flicker	Clause 8.6	N/A	N/A	
Immunity				
Test Item	Standard Requirement (ETSI EN301 489-1)	Result	Test Engineer	Remark
Radio Frequency Electromagnetic Field	Clause 9.2	Pass	Lykan Cai	
Electrostatic Discharge	Clause 9.3	Pass	Lykan Cai	
Fast Transients common mode	Clause 9.4	N/A	N/A	
Radio frequency common mode	Clause 9.5	N/A	N/A	
Voltage Dips and Interruptions	Clause 9.7	N/A	N/A	
Surges	Clause 9.8	N/A	N/A	

NOTE:

- (1) "N/A" denotes test is not applicable in this Test Report.
- (2) The power consumption of EUT is less than 75W and no Limits apply.
- (3) This product is DC product.



1.4 Test facility

Address of the report laboratory

CTC Laboratories, Inc.

Address: 2/F., Building 1 and 1-2/F., Building 2, Jiaquan Building, Guanlan High-Tech Park, Longhua District, Shenzhen, Guangdong, China

Laboratory accreditation

The test facility is recognized, certified, or accredited by the following organizations:

CNAS-Lab Code: L5365

CTC Laboratories, Inc. has been assessed and proved to be in compliance with CNAS-CL01 Accreditation. Criteria for Testing and Calibration Laboratories (identical to ISO/IEC17025: 2017 General Requirements) for the Competence of Testing and Calibration Laboratories.

A2LA-Lab Cert. No.: 4340.01

CTC Laboratories, Inc. EMC Laboratory has been accredited by A2LA for technical competence in the field of electrical testing, and proved to be in compliance with ISO/IEC 17025:2017 General Requirements for the Competence of Testing and Calibration Laboratories and any additional program requirements in the identified field of testing.

Industry Canada (Registration No.: 9783A,CAB Identifier:CN0029)

CTC Laboratories, Inc. EMC Laboratory has been registered by Certification and Engineer Bureau of Industry Canada for the performance of with Registration NO.: 9783A on Jan, 2016.

FCC (Registration No.: 951311, Designation Number CN1208)

CTC Laboratories, Inc. EMC Laboratory has been registered and fully described in a report filed with the (FCC) Federal Communications Commission. The acceptance letter from the FCC is maintained in our files. Registration 951311, Aug 26, 2017

1.5 Measurement uncertainty

The data and results referenced in this document are true and accurate. The reader is cautioned that there may be errors within the calibration limits of the equipment and facilities. The measurement uncertainty was calculated for all measurements listed in this test report acc. to TR-100028-01 "Electromagnetic compatibility and Radio spectrum Matters (ERM);Uncertainties in the measurement of mobile radio equipment characteristics; Part 1" and TR-100028-02 "Electromagnetic compatibility and Radio spectrum Matters (ERM);Uncertainties in the measurement of mobile radio equipment characteristics; Part 2 " and is documented in the CTC Laboratories, Inc. quality system acc. to DIN EN ISO/IEC 17025. Furthermore, component and process variability of devices similar to that tested may result in additional deviation. The manufacturer has the sole responsibility of continued compliance of the device. Below is the best measurement capability for CTC Laboratories, Inc.

CTC Laboratories, Inc.

2/F., Building 1 and 1-2/F., Building 2, Jiaquan Building, Guanlan High-Tech Park, Longhua District, Shenzhen, Guangdong, China
Tel.: (86)755-27521059 Fax: (86)755-27521011 Http://www.sz-ctc.org.cn



For anti-fake verification, please visit the official website of Certification and Accreditation Administration of the People's Republic of China : yz.cnca.cn



A. Conducted Measurement:

Test Site	Method	Measurement Frequency Range	U (dB)	NOTE
GTIC01	ANSI	150kHz ~ 30MHz	3.08	Main Power Port
	ANSI	150kHz ~ 30MHz	4.26	Telecommunication
	ANSI	30MHz ~ 300MHz	2.38	Clamp
	ANSI	30MHz ~ 2150MHz	4.2	Antenna Port

B. Radiated Measurement:

Test Site	Method	Measurement Frequency Range	U (dB)	NOTE
GTIA02	ANSI	30MHz ~ 1000MHz	4.51	3m
	ANSI	1000MHz ~ 6000MHz	5.84	3m
GTIA03	ANSI	30MHz ~ 1000MHz	4.52	10m

Note: (1) This uncertainty represents an expanded uncertainty expressed at approximately the 95% confidence level using a coverage factor of k=1.96.

1.6 Environmental conditions

During the measurement the environmental conditions were within the listed ranges:

Normal Temperature	22 °C ~ 27 °C
Relative Humidity	47 % ~ 53 %
Air Pressure	101 kPa ~ 102 kPa



2 GENERAL INFORMATION

2.1 General description of EUT

Product Name	TVOC Air Quality Monitor
Trade Mark	Aqara
Model/Type reference	AAQS-S01
Listed Model(s)	/
Model Difference	/
Product Description	Based on the application, features, or specification exhibited in User's Manual, the EUT is considered as both an ITE/Computing Device(Class B). More details of EUT technical specification, please refer to the User's Manual.
Manufacturer	Lumi United Technology Co., Ltd
Manufacturer Address	8th Floor, JinQi Wisdom Valley, No.1 Tangling Road, Liuxian Ave, Taoyuan Residential District, Nanshan District, Shenzhen,China
Factory	/
Factory Address	/
Power Source	DC 3V
Hardware version	N/A
Software version	N/A
Remark:	The maximum operating frequency of EUT's MCU is 48MHz (The product has wireless connection function. Frequency: 2.4GHz)
Zigbee	
Operation frequency:	2405-2480MHz
Modulation:	O-QPSK



2.2 Accessory equipment information

Equipment Information				
Name	Mfr/Brand	Model/Type No.	S/N	Note
Mobile phone	Huawei	P30	/	AE
Gateway	Aqara	M1S	/	AE
Cable Information				
Name	Shielded Type	Ferrite Core	Length	Note
/	/	/	/	/

Note:

- (1) The support equipment was authorized by Declaration of Confirmation.
- (2) For detachable type I/O cable should be specified the length in cm in 『Length』 column.
- (3) “YES” is means “shielded” “with core”; “NO” is means “unshielded” “without core”.

2.3 Description of test modes

As the function of the EUT, test mode selected to test as below to conform this standard.

Test mode	Description
1	Working
Test item	Test mode
Radiated Emission	1
Electrostatic Discharge	1
Radio Frequency Electromagnetic Field	1

CTC Laboratories, Inc.

2/F., Building 1 and 1-2/F., Building 2, Jiaquan Building, Guanlan High-Tech Park, Longhua District, Shenzhen, Guangdong, China
 Tel.: (86)755-27521059 Fax: (86)755-27521011 Http://www.sz-ctc.org.cn



For anti-fake verification, please visit the official website of Certification and Accreditation Administration of the People's Republic of China : yz.cnca.cn



2.4 Measurement instruments list

Radiated emission					
Item	Test Equipment	Manufacturer	Model No.	Serial No.	Calibrated until
1	Trilog-Broadband Antenna	Schwarzbeck	VULB 9168	9168-1013	Dec. 27, 2020
2	Horn Antenna	Schwarzbeck	BBHA 9120D	9120D-647	Dec. 27, 2020
3	Spectrum Analyzer	R&S	FSU26	100105	Dec. 27, 2020
4	Spectrum Analyzer	R&S	FSV40-N	101331	Dec. 27, 2020
5	Pre-Amplifier	SONOMA	310	186194	Dec. 27, 2020
6	Low Noise Pre-Amplifier	EMCI	EMC051835	980075	Dec. 27, 2020
7	Test Receiver	R&S	ESC17	100967	Dec. 27, 2020
Electrostatic discharge					
Item	Test Equipment	Manufacturer	Model No.	Serial No.	Calibrated until
1	ESD Simulator	EM TEST	DITO	V1113109156	Dec. 27, 2020
Radio frequency electromagnetic field					
Item	Test Equipment	Manufacturer	Model No.	Serial No.	Calibrated until
1	High Gain Log-Periodic Antenna	R&S	HL046E	100037	Dec. 27, 2020
2	Stacked Log.-Per. Antenna	Schwarzbeck	STLP 9149	9149-658	Dec. 27, 2020
3	Power Amplifier	BONN ELEKTRONIK	BLWA0830-160/100/40D	76788	Dec. 27, 2020
4	Power Amplifier	Micotop	MPA-3-6G-50	MPA1706258	Dec. 27, 2020
5	PSG Analog Signal Generator	Agilent	E8257D	MY46521908	Dec. 27, 2020
6	Turn Table	UC	UC3000	N/A	N/A

CTC Laboratories, Inc.

2/F., Building 1 and 1-2/F., Building 2, Jiaquan Building, Guanlan High-Tech Park, Longhua District, Shenzhen, Guangdong, China
 Tel.: (86)755-27521059 Fax: (86)755-27521011 Http://www.sz-ctc.org.cn



中国国家认证认可监督管理委员会
 Certification and Accreditation Administration of the People's Republic of China

For anti-fake verification, please visit the official website of Certification and Accreditation Administration of the People's Republic of China : yz.cnca.cn



3 EMC EMISSION TEST

3.1 Radiated emission measurement

LIMIT

Please refer to ETSI EN301489-1 Clause 8.2.3, Table 4 and CENELEC EN 55032 Annex A Table A.4 & A.5

FREQUENCY (MHz)	Class A dBuV/m		Class B dBuV/m	
	(at 10m)	(at 3m)	(at 10m)	(at 3m)
30 – 230	40	50	30	40
230 – 1000	47	57	37	47

FREQUENCY (MHz)	Class A (at 3m) dBuV/m		Class B (at 3m) dBuV/m	
	Peak	Average	Peak	Average
1000 - 3000	76	56	70	50
3000 - 6000	80	60	74	54

TEST MODE

Please refer to the Clause 2.3.

TEST SETUP

A. Radiated Emission test Set-up Frequency Below 1 GHz.

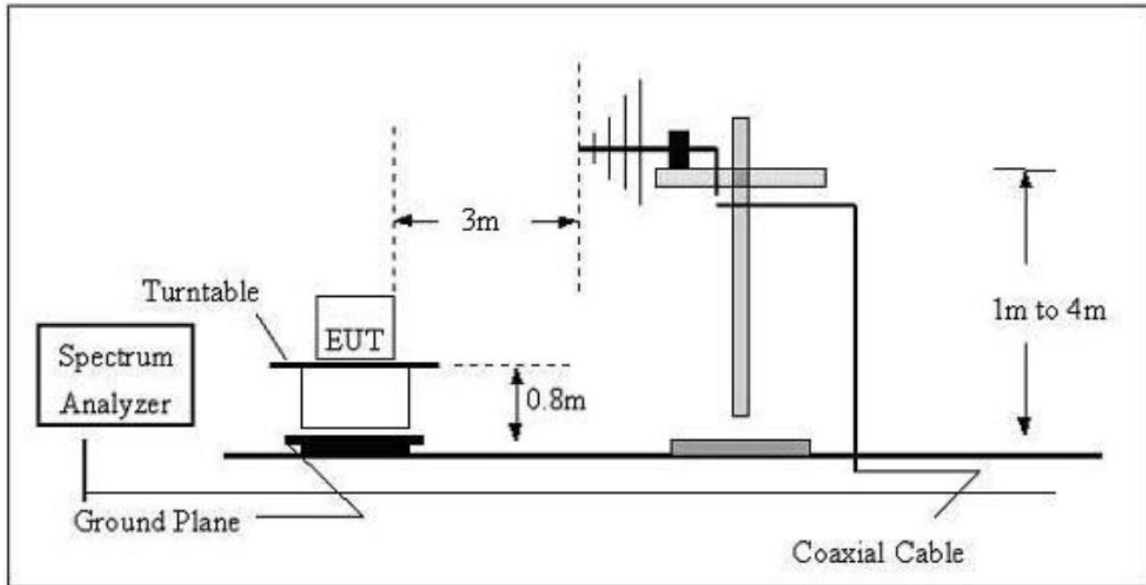

B. Radiated Emission test Set-up Frequency Above 1 GHz.

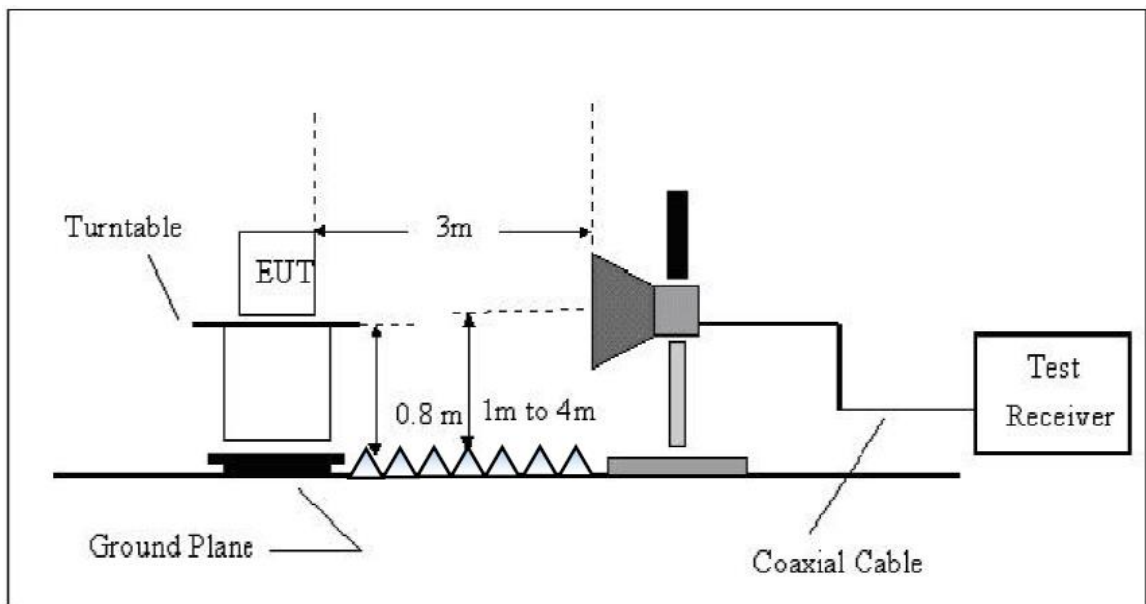

TEST RESULTS



Below 1 GHz

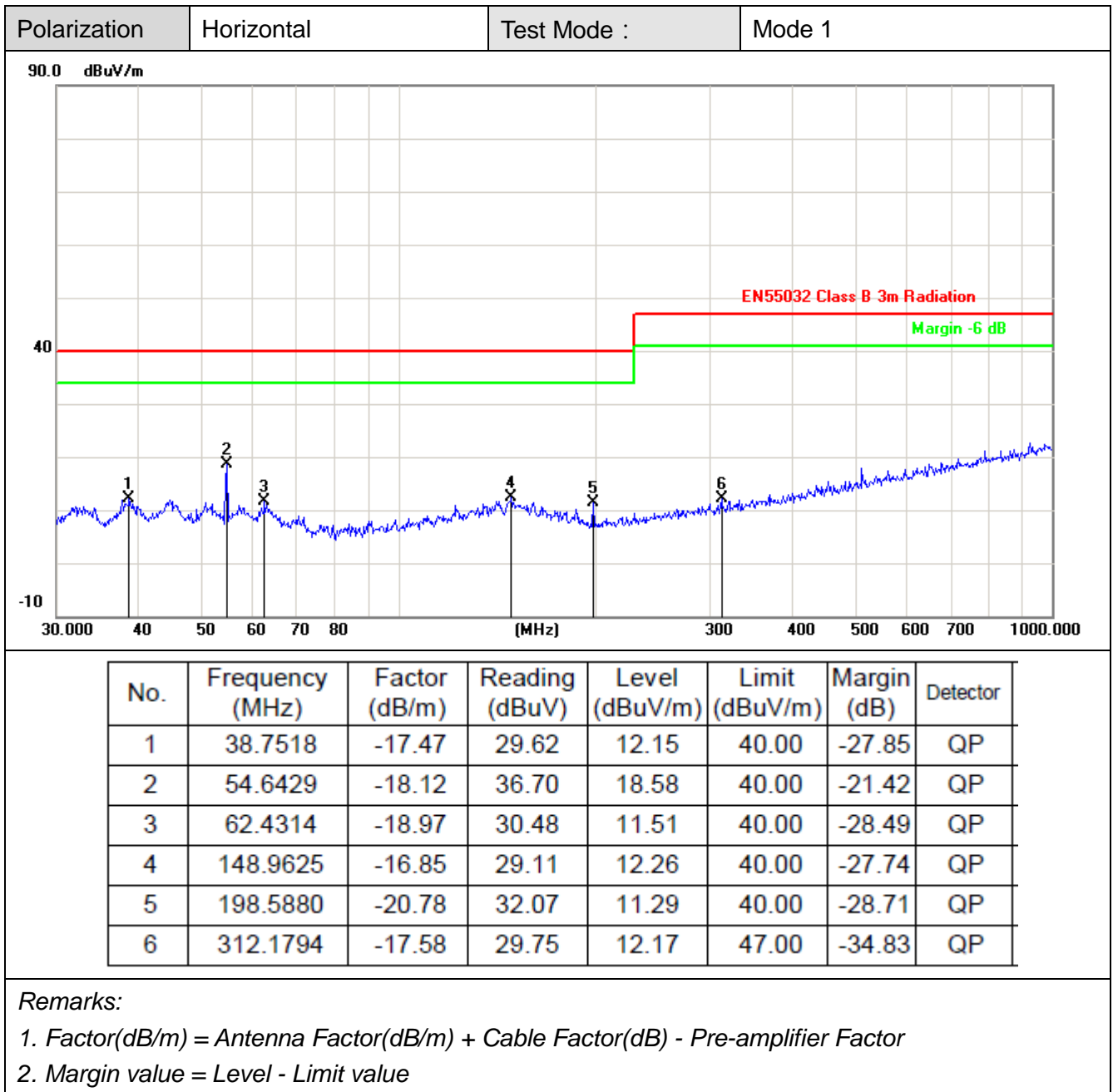



Polarization	Vertical	Test Mode :	Mode 1
--------------	----------	-------------	--------

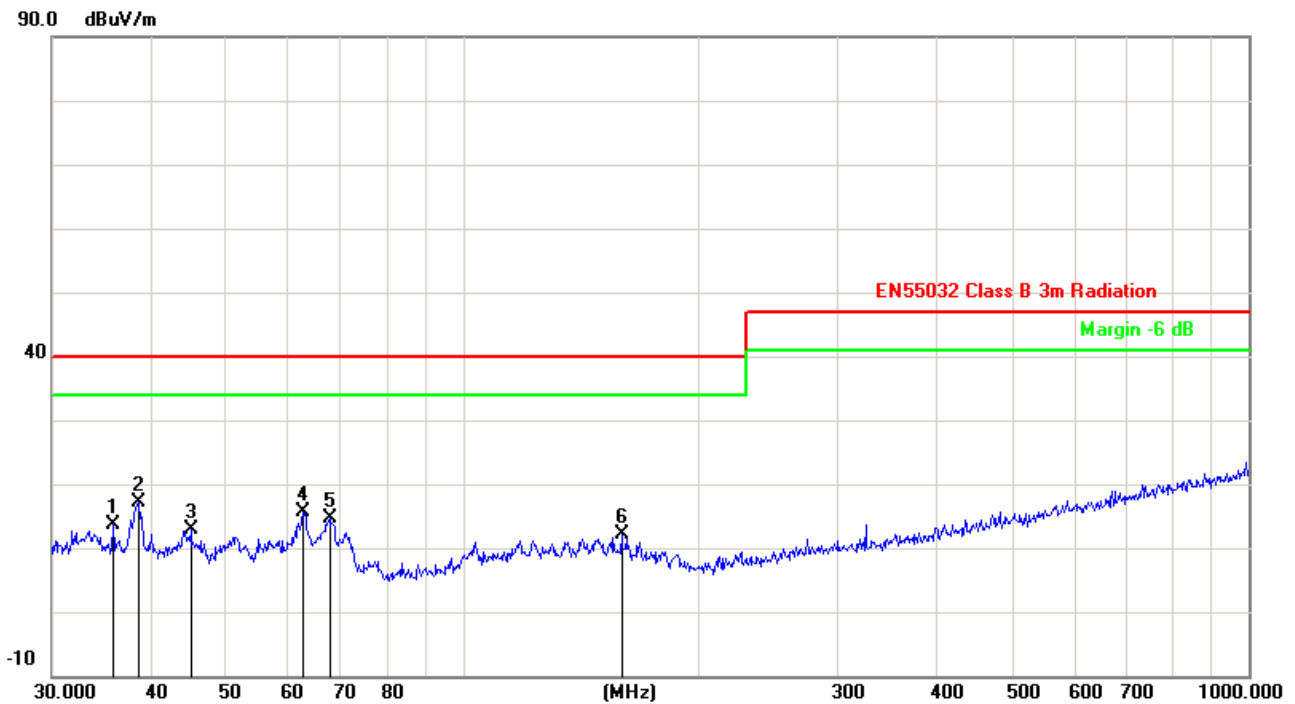

No.	Frequency (MHz)	Factor (dB/m)	Reading (dBuV)	Level (dBuV/m)	Limit (dBuV/m)	Margin (dB)	Detector
1	35.8746	-17.87	31.51	13.64	40.00	-26.36	QP
2	38.7518	-17.47	34.72	17.25	40.00	-22.75	QP
3	45.0583	-17.67	30.46	12.79	40.00	-27.21	QP
4	62.6507	-19.01	34.54	15.53	40.00	-24.47	QP
5	67.6751	-19.96	34.53	14.57	40.00	-25.43	QP
6	159.2251	-17.57	29.60	12.03	40.00	-27.97	QP

Remarks:

- Factor(dB/m) = Antenna Factor(dB/m) + Cable Factor(dB) - Pre-amplifier Factor
- Margin value = Level - Limit value



Above 1 GHz

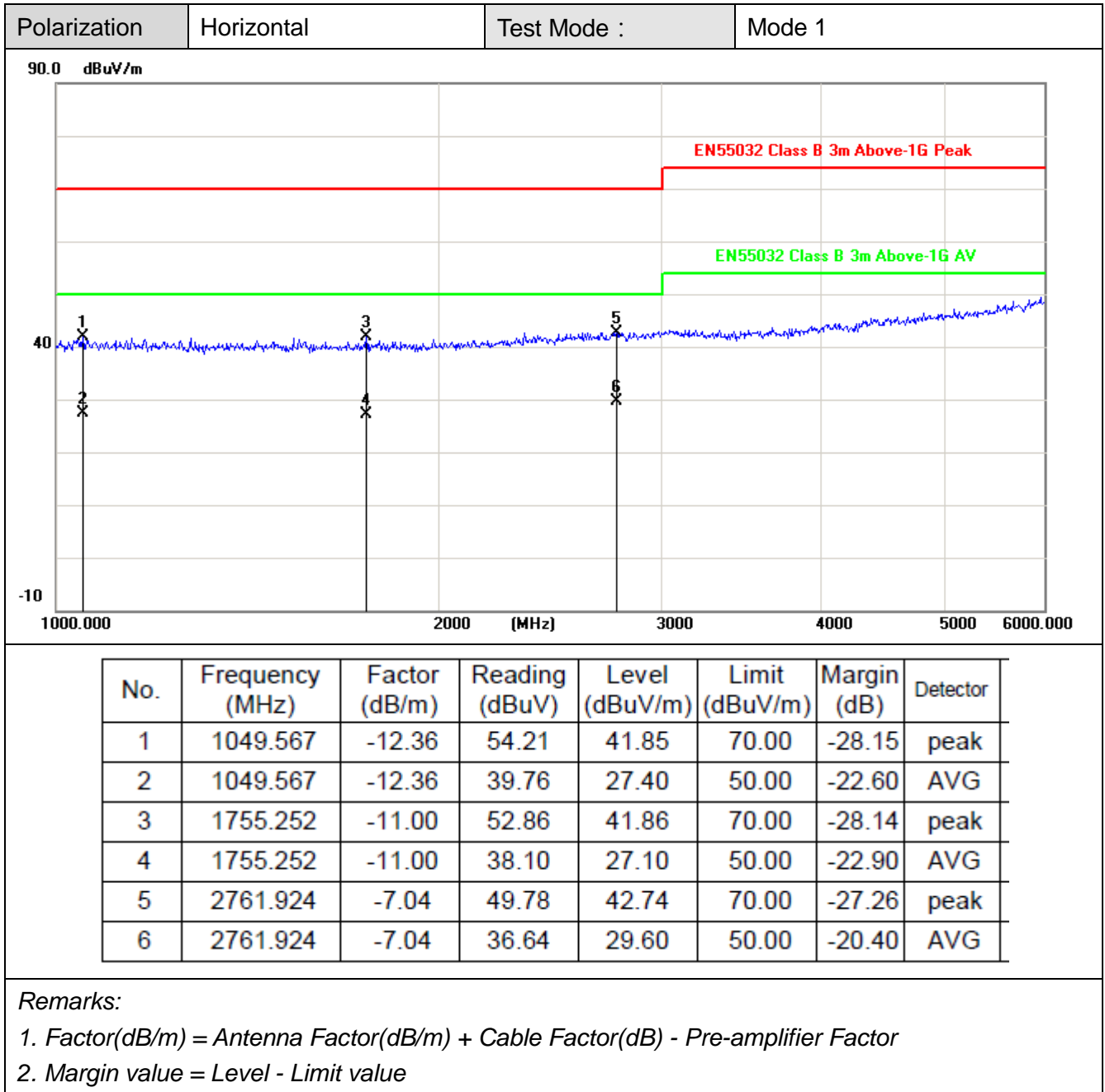



Polarization	Vertical	Test Mode :	Mode 1
--------------	----------	-------------	--------

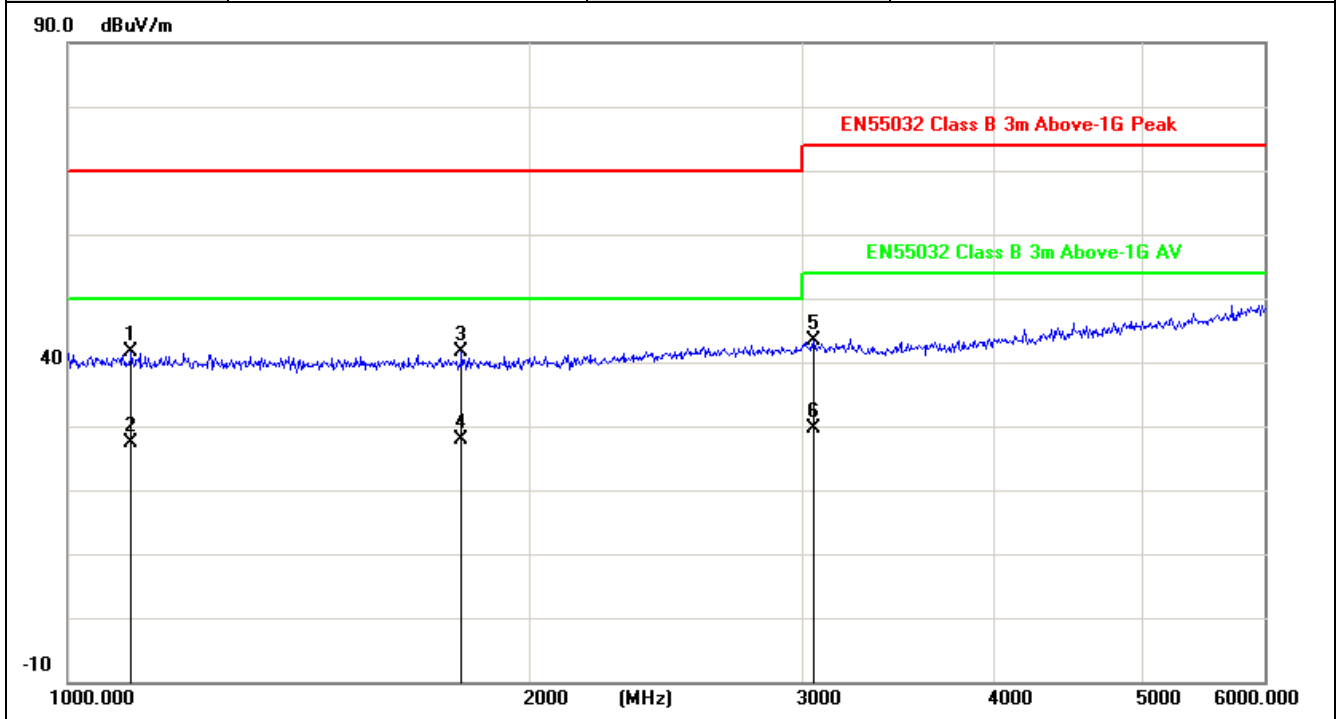

No.	Frequency (MHz)	Factor (dB/m)	Reading (dBuV)	Level (dBuV/m)	Limit (dBuV/m)	Margin (dB)	Detector
1	1099.618	-12.28	53.93	41.65	70.00	-28.35	peak
2	1099.618	-12.28	39.78	27.50	50.00	-22.50	AVG
3	1803.067	-10.93	52.55	41.62	70.00	-28.38	peak
4	1803.067	-10.93	38.73	27.80	50.00	-22.20	AVG
5	3053.432	-6.53	49.96	43.43	74.00	-30.57	peak
6	3053.432	-6.53	36.23	29.70	54.00	-24.30	AVG

Remarks:

- Factor(dB/m) = Antenna Factor(dB/m) + Cable Factor(dB) - Pre-amplifier Factor
- Margin value = Level - Limit value



4 EMC IMMUNITY TEST

Performance criteria

General performance criteria

- Performance criteria A for immunity tests with phenomena of a continuous nature;
- Performance criteria B for immunity tests with phenomena of a transient nature;
- Performance criteria C for immunity tests with power interruptions exceeding a certain time.

The equipment shall meet the minimum performance criteria as specified in the following.

Criteria	During test	After test
A	Shall operate as intended. May show degradation of performance (see note 1). Shall be no loss of function. Shall be no unintentional transmissions.	Shall operate as intended. Shall be no degradation of performance (see note 2). Shall be no loss of function. Shall be no loss of stored data or user programmable functions.
B	May show loss of function (one or more). May show degradation of performance(see note 1). No unintentional transmissions.	Functions shall be self-recoverable. Shall operate as intended after recovering. Shall be no degradation of performance (see note 2). Shall be no loss of stored data or user programmable functions.
C	May be loss of function (one or more).	Functions shall be recoverable by the operator. Shall operate as intended after recovering. Shall be no degradation of performance (see note 2).

NOTE 1:

Degradation of performance during the test is understood as a degradation to a level not below a minimum performance level specified by the manufacturer for the use of the apparatus as intended. In some cases the specified minimum performance level may be replaced by a permissible degradation of performance.

If the minimum performance level or the permissible performance degradation is not specified by the manufacturer then either of these may be derived from the product description and documentation (including leaflets and advertising) and what the user may reasonably expect from the apparatus if used as intended.

NOTE 2:

No degradation of performance after the test is understood as no degradation below a minimum performance level specified by the manufacturer for the use of the apparatus as intended. In some cases the specified minimum performance level may be replaced by a permissible degradation of performance. After the test no change of actual operating data or user retrievable data is allowed.

If the minimum performance level or the permissible performance degradation is not specified by the manufacturer then either of these may be derived from the product description and documentation (including leaflets and advertising) and what the user may reasonably expect from the apparatus if used as intended.

CTC Laboratories, Inc.

2/F., Building 1 and 1-2/F., Building 2, Jiaquan Building, Guanlan High-Tech Park, Longhua District, Shenzhen, Guangdong, China
Tel.: (86)755-27521059 Fax: (86)755-27521011 Http://www.sz-ctc.org.cn



For anti-fake verification, please visit the official website of Certification and Accreditation Administration of the People's Republic of China : yz.cnca.cn



4.1 Electrostatic discharge

PERFORMANCE CRITERION

Standard	Criterion
ETSI EN301489-1	Criteria B

TEST LEVEL

Contact Discharge at: ±2kV, ±4kV;

Air Discharge at: ±2kV, ±4kV, ±8kV

TEST PROCEDURE

Please refer to ETSI EN 301 489-1 Clause 9.3.2 and EN 61000-4-2 for the measurement methods.

Contact Discharge:

The ESD generator is held perpendicular to the surface to which the discharge is applied and the tip of the discharge electrode touch the surface of EUT. Then turn the discharge switch. The generator is then re-triggered for a new single discharge and repeated at least 10 times for each pre-selected test point. This procedure shall be repeated until all the air discharge completed.

Air Discharge:

Air discharge is used where contact discharge can't be applied. The round discharge tip of the discharge electrode shall be approached as fast as possible to touch the EUT. After each discharge, the discharge electrode shall be removed from the EUT. The generator is then re-triggered for a new single discharge and repeated at least 10 times for each pre-selected test point. This procedure shall be repeated until all the air discharge completed.

Indirect discharge for horizontal coupling plane:

At least 10 single discharges shall be applied to the horizontal coupling plane, at points on each side of the EUT.

Indirect discharge for vertical coupling plane:

At least 10 single discharges shall be applied to the center of one vertical edge of the coupling plane. The coupling plane, of dimensions 0.5m X 0.5m, is placed parallel to, and positioned at a distance of 0.1m from the EUT. Discharges shall be applied to the coupling plane, with this plane in sufficient different positions that the four faces of the EUT are completely illuminated.



TEST SETUP

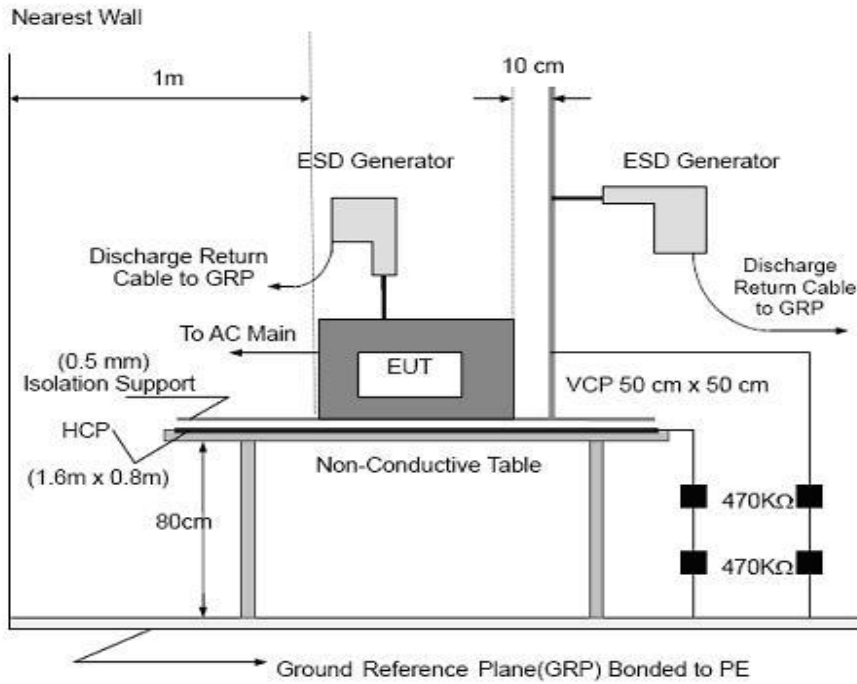

TEST RESULTS

Temperature	24°C	Humidity	56%	Atmospheric pressure	101kPa
Type	Type of discharge	Discharge voltage (kV)	Observations Performance	Criteria Level	Result
Direct	Contact discharge	±2	A	B	Pass
		±4	A	B	
	Air discharge	±2	A	B	
		±4	A	B	
		±8	A	B	
Indirect	HCP, VCP	±4	A	B	Pass

Note: The ancillary equipment's specification for an acceptable level of performance or degradation of performance during and/or after the ESD tests.



4.2 Radio frequency electromagnetic field

PERFORMANCE CRITERION

Standard	Criterion
ETSI EN301489-1	Criteria A

TEST LEVEL

Condition of Test	Remark
Frequency Range	80 MHz - 6000 MHz
Field Strength	3 V/m
Modulation	1kHz Sine Wave, 80%, AM Modulation
Frequency Step	1 % of fundamental
Polarity of Antenna	Horizontal and Vertical
Test Distance	3 m
Antenna Height	1.5 m
Dwell Time	at least 3 seconds

TEST PROCEDURE

Please refer to ETSI EN 301 489-1 Clause 9.2.2 and EN 61000-4-3 for the measurement methods.

TEST MODE

Please refer to the Clause 2.3.



TEST SETUP

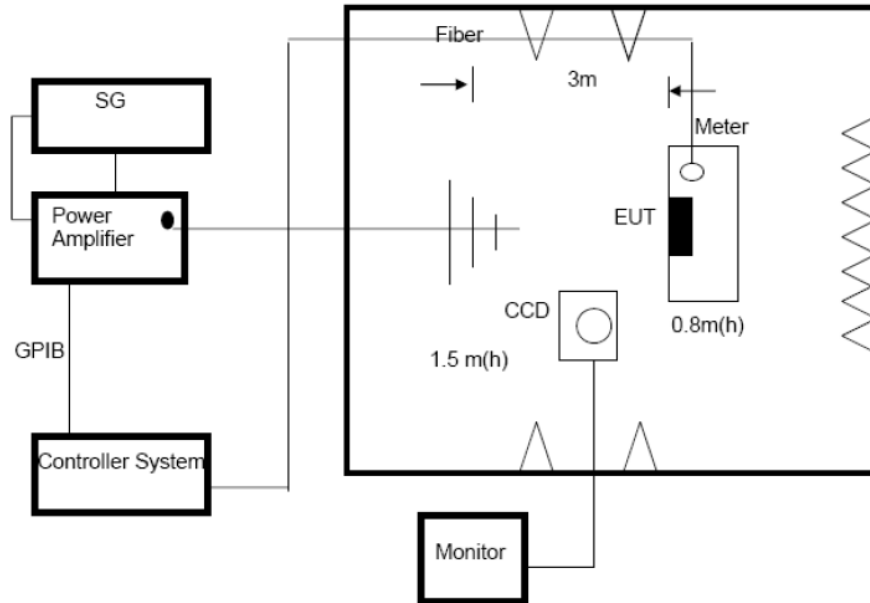

TEST RESULTS

Frequency Rang	Antenna Polarity	Observations (Performance Criterion)	Criteria Level	Result
80 MHz - 6000 MHz	H/V	A	A	Pass

5 EUT TEST PHOTO

Radiated Measurement (30MHz~1000MHz)

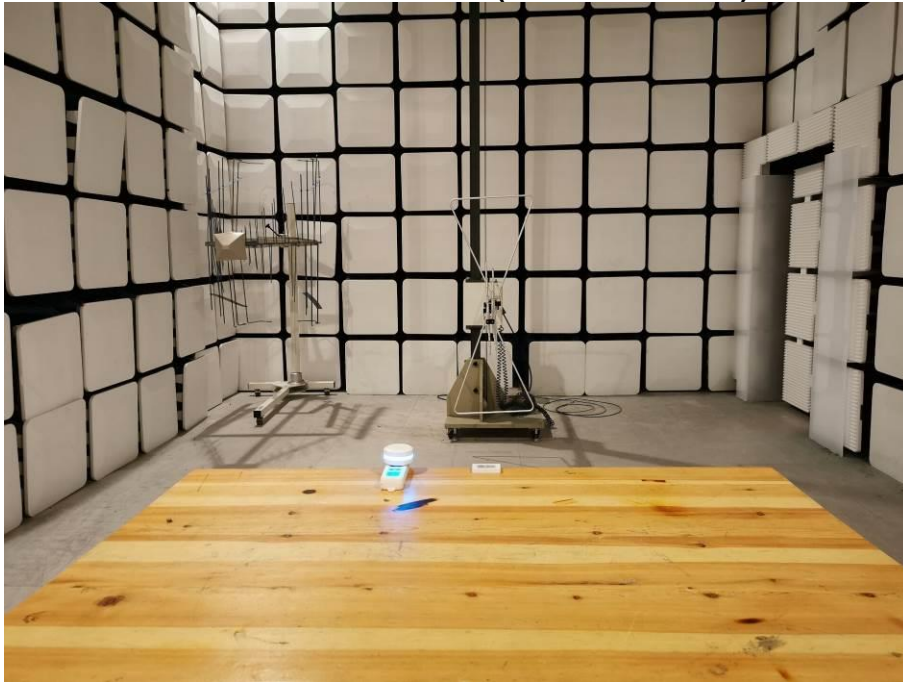

Radiated Measurement (1000MHz~6000MHz)

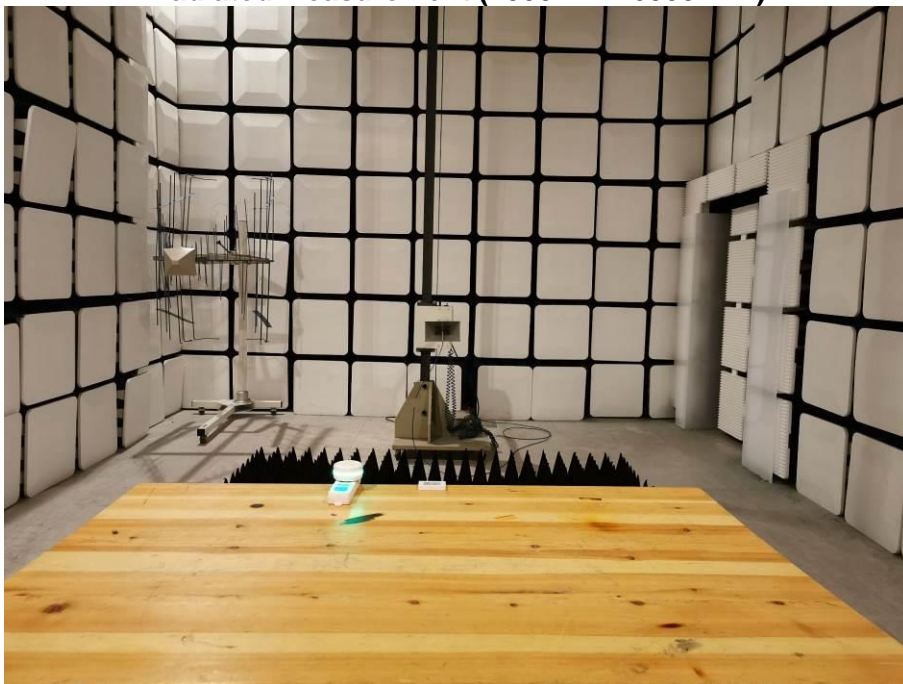

ESD Test Photo

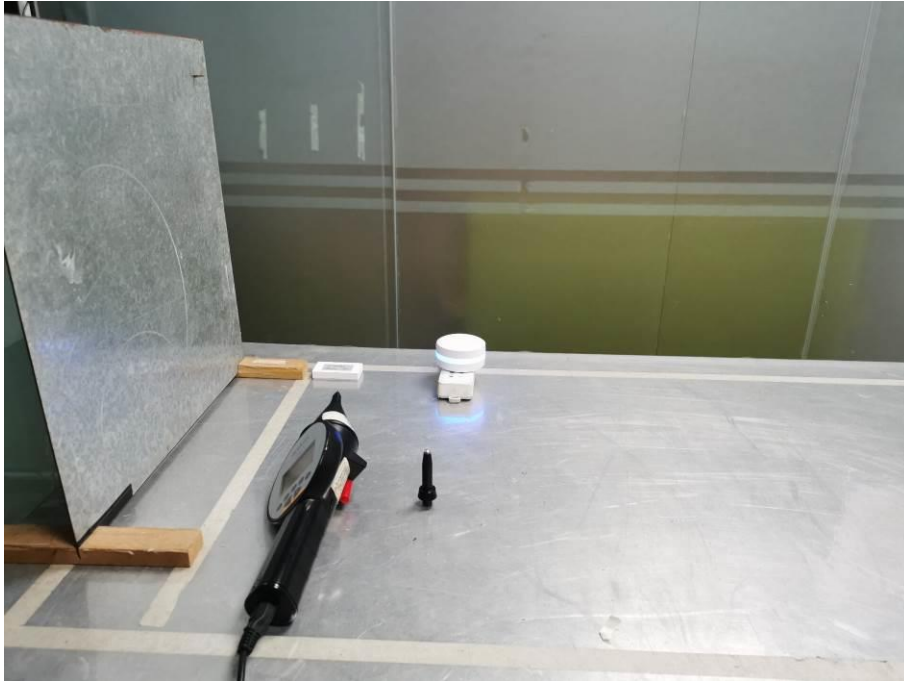

R/S Test Photo

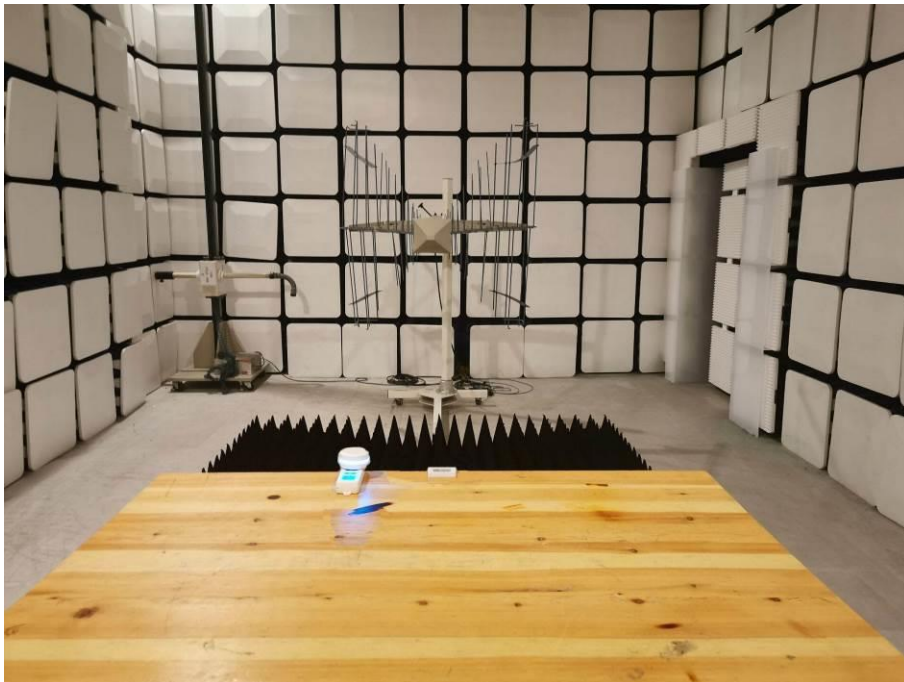

CTC Laboratories, Inc.

2/F., Building 1 and 1-2/F., Building 2, Jiaquan Building, Guanlan High-Tech Park, Longhua District, Shenzhen, Guangdong, China
Tel.: (86)755-27521059 Fax: (86)755-27521011 Http://www.sz-ctc.org.cn

6 PHOTOGRAPHS OF EUT

1. Photo

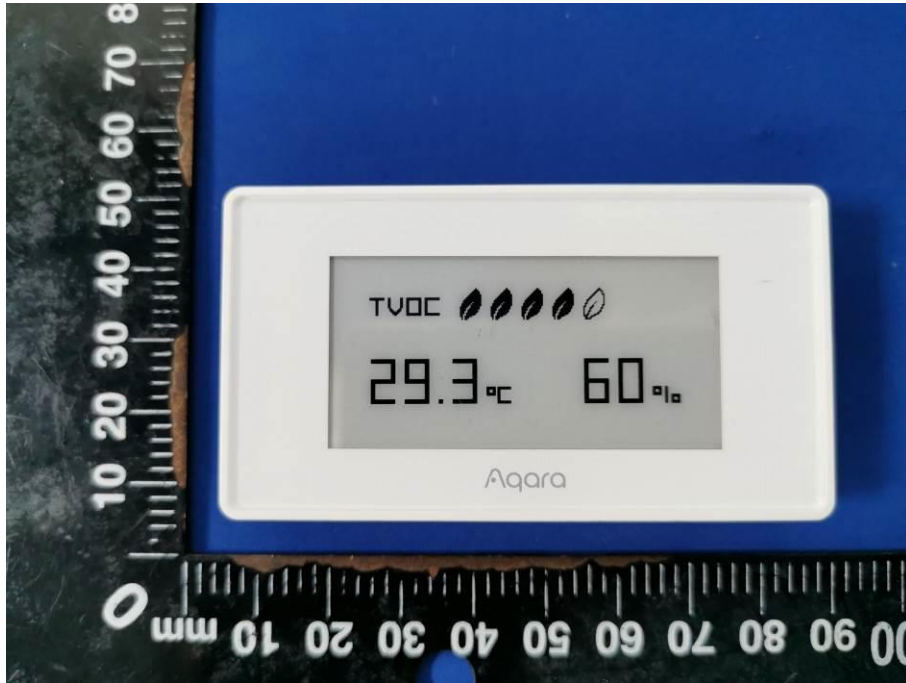

2. Photo



3. Photo

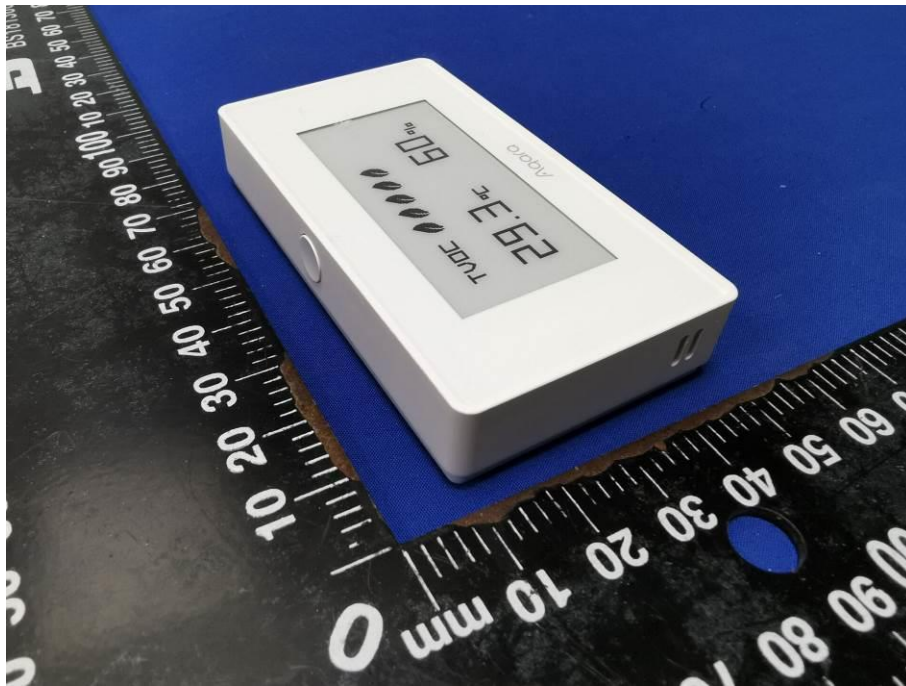

4. Photo

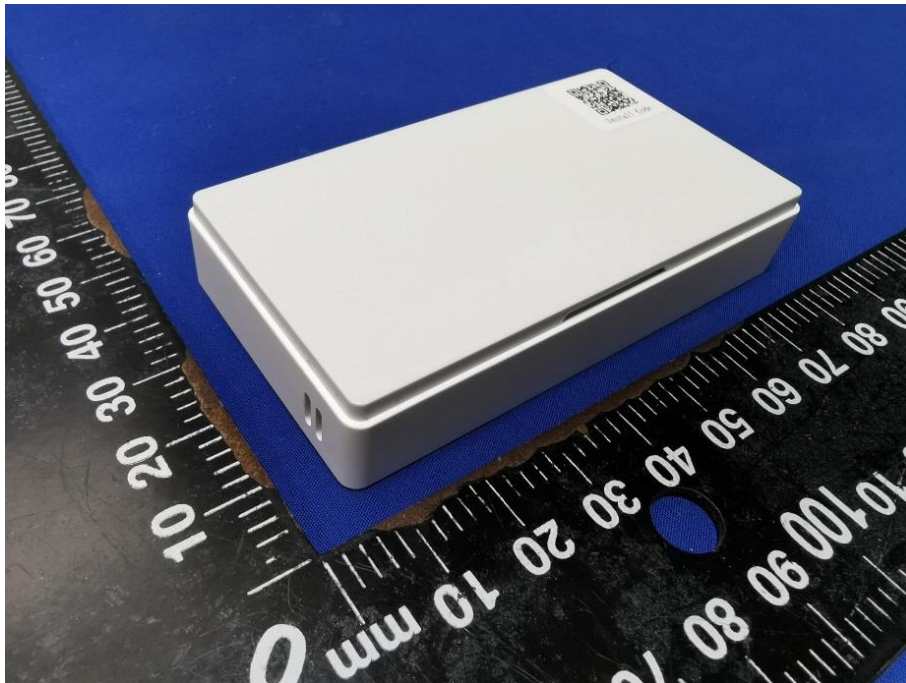

5. Photo

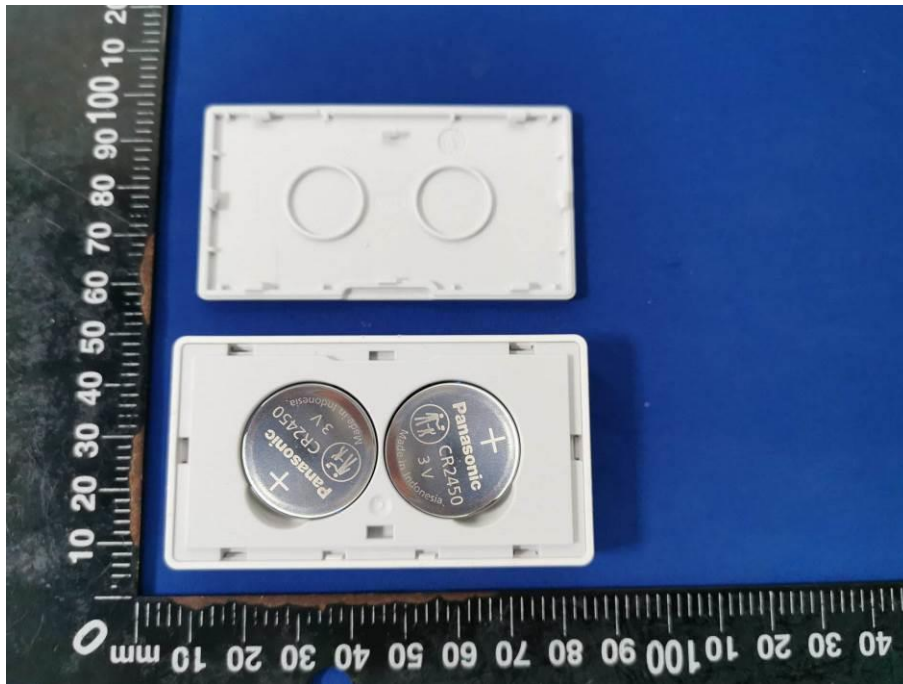

6. Photo

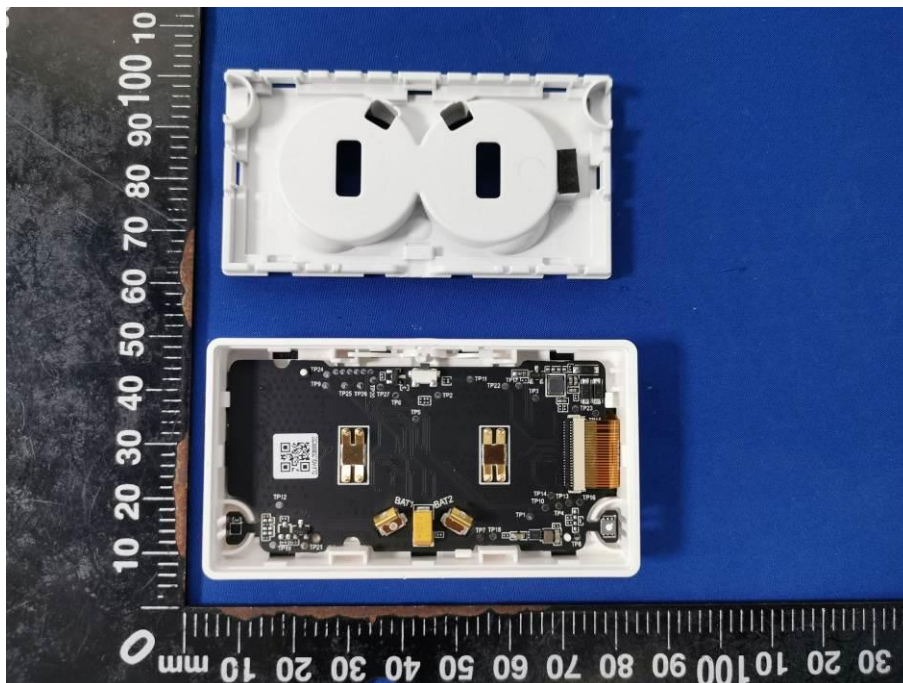

7. Photo

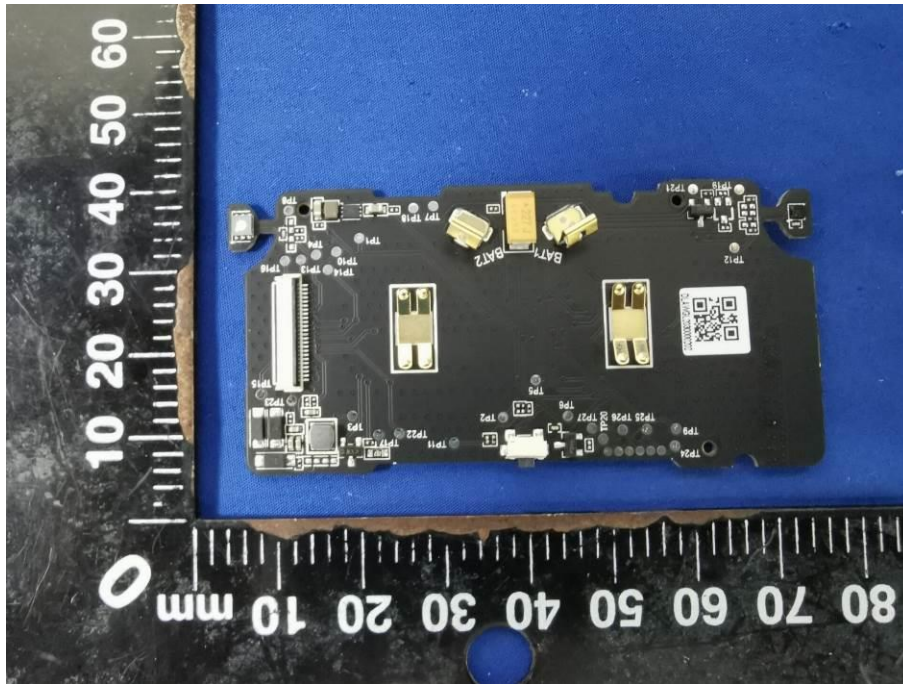

8. Photo

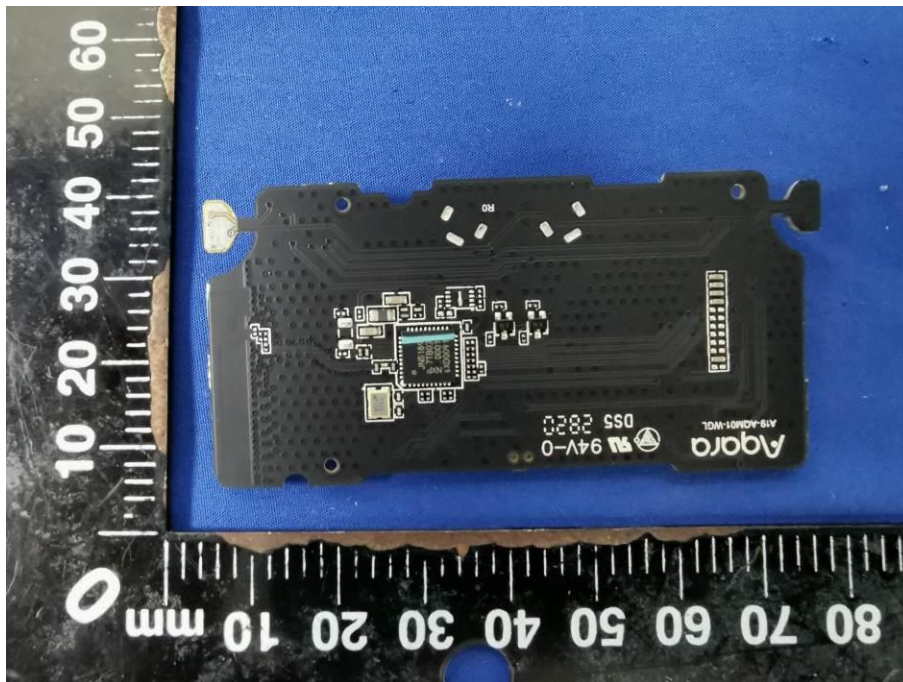

9. Photo



10. Photo



*****THE END*****