



RADIO TEST REPORT

ETSI EN 301 893 V2.1.1 (2017-05)

Product : Mobile Phone

Trade Mark : Blackview

Model Name : A85

Family Model : N/A

Report No. : STR22102801004E

Prepared for

DOKE COMMUNICATION (HK) LIMITED
RM 1902 EASEY COMM BLDG 253-261 HENNESSY ROAD WANCHAI
HK CHINA

Prepared by

Shenzhen NTEK Testing Technology Co., Ltd.
1/F, Building E, Fenda Science Park, Sanwei Community, Xixiang Street
Bao'an District, Shenzhen 518126 P.R. China
Tel. 400-800-6106, 0755-2320 0050, 0755-2320 0090
Website: <http://www.ntek.org.cn>

Table of Contents

Page

1 . SUMMARY OF TEST RESULTS	6
1.1 TEST FACILITY	7
1.2 MEASUREMENT UNCERTAINTY	7
2 . GENERAL INFORMATION	8
2.1 GENERAL DESCRIPTION OF EUT	8
2.2 TEST CONDITIONS AND CHANNEL	10
2.3 DESCRIPTION OF TEST CONDITIONS	11
2.4 DESCRIPTION OF SUPPORT UNITS	12
2.5 EQUIPMENTS LIST FOR ALL TEST ITEMS	13
3 . CENTRE FREQUENCIES	14
3.1 APPLIED PROCEDURES / LIMIT	14
3.1.1 LIMIT	14
3.1.2 TEST PROCEDURES	14
3.1.3 TEST MOTHOD	14
3.1.4 TEST SETUP LAYOUT	15
3.1.5 TEST RESULTS	16
4 . NOMINAL CHANNEL BANDWIDTH AND OCCUPIED CHANNEL BANDWIDTH19	
4.1 APPLIED PROCEDURES / LIMIT	19
4.1.1 LIMIT	19
4.1.2 TEST PROCEDURES	19
4.1.3 TEST METHOD	20
4.1.4 TEST SETUP LAYOUT	20
4.1.5 TEST RESULTS	21
5 . RF OUTPUT POWER, TRANSMIT POWER CONTROL (TPC) AND POWER DENSITY	22
5.1 APPLIED PROCEDURES / LIMIT	22
5.2 TEST PROCEDURES	22
5.3 TEST SETUP LAYOUT	22
5.4 TEST RESULTS	23
6 . TRANSMITTER UNWANTED EMISSIONS OUTSIDE THE 5 GHZ RLAN BANDS24	
6.1 APPLIED PROCEDURES / LIMIT	24
6.1.1 CONFORMANCE	24
6.1.2 TEST RESULTS (30MHz ~ 1000MHz)	25
6.1.3 TEST RESULTS (1.0GHz ~26GHz)	26
7 . TRANSMITTER UNWANTED EMISSIONS WITHIN THE 5 GHZ RLAN BANDS27	
7.1 APPLIED PROCEDURES / LIMIT	27
7.1.1 TEST PROCEDURES	27
7.1.2 TEST SETUP LAYOUT	27

Table of Contents

Page

7.1.3 TEST RESULTS	28
8 . RECEIVER SPURIOUS EMISSIONS	29
8.1 APPLIED PROCEDURES / LIMIT	29
8.1.1 TEST PROCEDURES	29
8.1.2 TEST SETUP LAYOUT	29
8.1.3 TEST RESULTS	30
9 . ADAPTIVITY (CHANNEL ACCESS MECHANISM)	31
9.1 APPLICABILITY OF ADAPTIVE REQUIREMENTS AND LILIT	31
9.2 TEST SETUP CONFIGURATION	32
9.3 LIST OF MEASUREMENTS	32
9.4 TEST RESULTS	32
10 . RECEIVER BLOCKING	33
10.1 LIMITS OF RECEIVER BLOCKING	33
10.2 TEST PROCEDURE	33
10.3 DEVIATION FROM TEST STANDARD	33
10.4 TEST SETUP	33
10.5 TEST RESULTS	34
11 . USER ACCESS RESTRICTIONS	35
11.1 APPLIED PROCEDURES / LIMIT	35
11.2 TEST RESULTS	35
12 . GEO-LOCATION CAPABILITY	35
12.1 APPLIED PROCEDURES / LIMIT	35
12.2 TEST RESULTS	35
13 TEST RESULTS	36
13.1 Occupied Channel Bandwidth	36
13.2 RF Output Power	40
13.3 Power Spectral Density	44
13.4 Transmitter unwanted emissions in the spurious domain	48
13.5 Transmitter unwanted emissions within the 5 GHz RLAN bands	54
13.6 Receiver spurious emissions	61
13.7 Adaptivity	65
13.8 Adaptivity COT Channel Occupancy Time	73
13.9 Adaptivity COT Idle Period Probability	76
14. EUT TEST PHOTO	79
SPURIOUS EMISSIONS MEASUREMENT PHOTOS	79
APPENDIX-PHOTOGRAPHS OF EUT CONSTRUCTIONAL DETAILS	

1. SUMMARY OF TEST RESULTS

Test procedures according to the technical standards:

ETSI EN 301 893 V2.1.1			
Clause	Test Item	Applicable	NOTE
4.2.1	Centre Frequencies	Compliance	
4.2.2	Nominal Channel Bandwidth and Occupied Channel Bandwidth	Compliance	
4.2.3	RF output power	Compliance	
4.2.3	Transmit Power Control (TPC)	Not Applicable	
4.2.3	Power Density	Compliance	
4.2.4.1	Transmitter unwanted emissions outside the 5 GHz RLAN bands	Compliance	
4.2.4.2	Transmitter unwanted emissions within the 5 GHz RLAN bands	Compliance	
4.2.5	Receiver spurious emissions	Compliance	
4.2.6	Dynamic Frequency Selection (DFS)	Not Applicable	
4.2.7	Adaptivity (Channel Access Mechanism)	Compliance	
4.2.8	Receiver Blocking	Compliance	
4.2.9	User Access Restrictions	Compliance*	
4.2.10	Geo-location capability	Compliance*	

Note:

1. Compliance*: Please refer to the product information declared by the manufacturer.
2. The antenna gain provided by customer is used to calculate the EIRP result. NTEK is not responsible for the accuracy of antenna gain parameter.

1.1 TEST FACILITY

Shenzhen NTEK Testing Technology Co., Ltd.

Add. : 1/F, Building E, Fenda Science Park, Sanwei Community, Xixiang Street, Bao'an District, Shenzhen 518126 P.R. China

FCC Registered No.: 238937 IC Registered No.:9270A-1

CNAS Registration No.:L5516

1.2 MEASUREMENT UNCERTAINTY

The reported uncertainty of measurement $y \pm U$, where expanded uncertainty U is based on a standard uncertainty multiplied by a coverage factor of $k=2$, providing a level of confidence of approximately **95 %**.

No.	Item	Uncertainty
1	Conducted Emission Test	$\pm 1.38\text{dB}$
2	RF power,conducted	$\pm 0.16\text{dB}$
3	Spurious emissions,conducted	$\pm 0.21\text{dB}$
4	All emissions,radiated(<1G)	$\pm 4.68\text{dB}$
5	All emissions,radiated(>1G)	$\pm 4.89\text{dB}$
6	Temperature	$\pm 0.5^\circ\text{C}$
7	Humidity	$\pm 2\%$

2. GENERAL INFORMATION

2.1 GENERAL DESCRIPTION OF EUT

Equipment	Mobile Phone												
Trade Mark	Blackview												
Model Name.	A85												
Family Model	N/A												
Model Difference	N/A												
Product Description	The EUT is a Mobile Phone												
	<table border="1"> <tr> <td>Operation Frequency:</td> <td>802.11a/ n(20/40)/ac(20/40/80): <input checked="" type="checkbox"/>5180MHz~5240MHz(20MHz) <input checked="" type="checkbox"/>5190MHz~5230MHz(40MHz) <input checked="" type="checkbox"/>5210MHz(80MHz)</td> </tr> <tr> <td>Modulation Type:</td> <td>802.11a: OFDM (BPSK / QPSK / 16QAM) 802.11n: OFDM (QPSK/BPSK/16QAM/64QAM) 802.11ac:OFDM (QPSK/BPSK/16QAM/64QAM/256QAM)</td> </tr> <tr> <td>Bit Rate of Transmitter</td> <td>802.11a: 6/9/12/18/24/36/48/54Mbps; 802.11n (20MHz): up to MCS0-7 802.11n (40MHz): up to MCS0-7 802.11ac (20MHz): up to MCS0-8 802.11ac (40MHz): up to MCS0-9 802.11ac (80MHz): up to MCS0-9</td> </tr> <tr> <td>Number Of Channel</td> <td>Please see Note 2.</td> </tr> <tr> <td>Antenna Designation:</td> <td>PIFA Antenna</td> </tr> <tr> <td>Antenna Gain(Peak)</td> <td>0.57 dBi</td> </tr> </table>	Operation Frequency:	802.11a/ n(20/40)/ac(20/40/80): <input checked="" type="checkbox"/> 5180MHz~5240MHz(20MHz) <input checked="" type="checkbox"/> 5190MHz~5230MHz(40MHz) <input checked="" type="checkbox"/> 5210MHz(80MHz)	Modulation Type:	802.11a: OFDM (BPSK / QPSK / 16QAM) 802.11n: OFDM (QPSK/BPSK/16QAM/64QAM) 802.11ac:OFDM (QPSK/BPSK/16QAM/64QAM/256QAM)	Bit Rate of Transmitter	802.11a: 6/9/12/18/24/36/48/54Mbps; 802.11n (20MHz): up to MCS0-7 802.11n (40MHz): up to MCS0-7 802.11ac (20MHz): up to MCS0-8 802.11ac (40MHz): up to MCS0-9 802.11ac (80MHz): up to MCS0-9	Number Of Channel	Please see Note 2.	Antenna Designation:	PIFA Antenna	Antenna Gain(Peak)	0.57 dBi
	Operation Frequency:	802.11a/ n(20/40)/ac(20/40/80): <input checked="" type="checkbox"/> 5180MHz~5240MHz(20MHz) <input checked="" type="checkbox"/> 5190MHz~5230MHz(40MHz) <input checked="" type="checkbox"/> 5210MHz(80MHz)											
	Modulation Type:	802.11a: OFDM (BPSK / QPSK / 16QAM) 802.11n: OFDM (QPSK/BPSK/16QAM/64QAM) 802.11ac:OFDM (QPSK/BPSK/16QAM/64QAM/256QAM)											
	Bit Rate of Transmitter	802.11a: 6/9/12/18/24/36/48/54Mbps; 802.11n (20MHz): up to MCS0-7 802.11n (40MHz): up to MCS0-7 802.11ac (20MHz): up to MCS0-8 802.11ac (40MHz): up to MCS0-9 802.11ac (80MHz): up to MCS0-9											
	Number Of Channel	Please see Note 2.											
	Antenna Designation:	PIFA Antenna											
	Antenna Gain(Peak)	0.57 dBi											
Based on the application, features, or specification exhibited in User's Manual, the EUT is considered as an ITE/Computing Device. More details of EUT technical specification, please refer to the User's Manual.													
Channel List	Refer to below												
Adapter	Model: QZ-01800EA00 Input: 100-240V~50/60Hz 0.5A Output: 5.0V---3.0A or 7.0V---2.0A or 9.0V---2.0A or 12.0V---1.5A (18.0W)												
Battery	DC 3.85V, 4480mAh, 17.248Wh												
Rating	DC 3.85V from battery or DC 5V from adapter												
Hardware Version	S681_V1												
Software Version	A85_EEA_S6063_V1.1												

Note:																																							
1.	For a more detailed features description, please refer to the manufacturer's specifications or the User's Manual.																																						
2.	<input checked="" type="checkbox"/> <table border="1" style="width: 100%; text-align: center;"> <tr> <td colspan="8">802.11a/n/ac(20MHz) Carrier Frequency Channel</td> </tr> <tr> <td>Channel</td> <td>Frequen cy (MHz)</td> <td>Channel</td> <td>Frequen cy (MHz)</td> <td>Channel</td> <td>Frequen cy (MHz)</td> <td>Channel</td> <td>Frequen cy (MHz)</td> </tr> <tr> <td>36</td> <td>5180</td> <td>44</td> <td>5220</td> <td>-</td> <td>-</td> <td>-</td> <td>-</td> </tr> <tr> <td>40</td> <td>5200</td> <td>48</td> <td>5240</td> <td>-</td> <td>-</td> <td>-</td> <td>-</td> </tr> </table>							802.11a/n/ac(20MHz) Carrier Frequency Channel								Channel	Frequen cy (MHz)	Channel	Frequen cy (MHz)	Channel	Frequen cy (MHz)	Channel	Frequen cy (MHz)	36	5180	44	5220	-	-	-	-	40	5200	48	5240	-	-	-	-
802.11a/n/ac(20MHz) Carrier Frequency Channel																																							
Channel	Frequen cy (MHz)	Channel	Frequen cy (MHz)	Channel	Frequen cy (MHz)	Channel	Frequen cy (MHz)																																
36	5180	44	5220	-	-	-	-																																
40	5200	48	5240	-	-	-	-																																
	<input checked="" type="checkbox"/> <table border="1" style="width: 100%; text-align: center;"> <tr> <td colspan="8">802.11n/ac(40MHz) Carrier Frequency Channel</td> </tr> <tr> <td>Channel</td> <td>Frequen cy (MHz)</td> <td>Channel</td> <td>Frequen cy (MHz)</td> <td>Channel</td> <td>Frequen cy (MHz)</td> <td>Channel</td> <td>Frequen cy (MHz)</td> </tr> <tr> <td>38</td> <td>5190</td> <td>-</td> <td>-</td> <td>-</td> <td>-</td> <td>-</td> <td>-</td> </tr> <tr> <td>46</td> <td>5230</td> <td>-</td> <td>-</td> <td>-</td> <td>-</td> <td>-</td> <td>-</td> </tr> </table>							802.11n/ac(40MHz) Carrier Frequency Channel								Channel	Frequen cy (MHz)	Channel	Frequen cy (MHz)	Channel	Frequen cy (MHz)	Channel	Frequen cy (MHz)	38	5190	-	-	-	-	-	-	46	5230	-	-	-	-	-	-
802.11n/ac(40MHz) Carrier Frequency Channel																																							
Channel	Frequen cy (MHz)	Channel	Frequen cy (MHz)	Channel	Frequen cy (MHz)	Channel	Frequen cy (MHz)																																
38	5190	-	-	-	-	-	-																																
46	5230	-	-	-	-	-	-																																
	<input checked="" type="checkbox"/> <table border="1" style="width: 100%; text-align: center;"> <tr> <td colspan="2">802.11ac (80MHz) Carrier Frequency Channel</td> </tr> <tr> <td>Channel</td> <td>Frequency (MHz)</td> </tr> <tr> <td>42</td> <td>5210</td> </tr> </table>							802.11ac (80MHz) Carrier Frequency Channel		Channel	Frequency (MHz)	42	5210																										
802.11ac (80MHz) Carrier Frequency Channel																																							
Channel	Frequency (MHz)																																						
42	5210																																						

2.2 TEST CONDITIONS AND CHANNEL

Test conditions:

	Normal Test Conditions	Extreme Test Conditions
Temperature	15°C - 35°C	40°C ~ -10°C Note: (1)
Relative Humidity	20% - 75%	N/A
Supply Voltage	DC 3.85V	/

Note:

(1) The HT 40°C and LT -10°C was declared by manufacturer, The EUT couldn't be operate normally with higher or lower temperature.

Test channels:

Please refer to the table below:

Test	Clause	Test channels		
		Lower sub-band (5 150 MHz to 5 350 MHz)		Higher sub-band 5 470 MHz to 5 725 MHz
		5 150 MHz to 5 250 MHz	5 250 MHz to 5 350 MHz	
Centre frequencies	5.4.2	C7 (see note 1)		C8 (see note 1)
Occupied Channel Bandwidth	5.4.3	C7		C8
Power/ Power Density	5.4.4	C1	C2	C3, C4
Transmitter unwanted emissions outside the 5 GHz RLAN bands	5.4.5	C7 (see note 1)		C8 (see note 1)
Transmitter unwanted emissions within the 5 GHz RLAN bands	5.4.6	C1	C2	C3, C4
Receiver spurious emissions	5.4.7	C7 (see note 1)		C8 (see note 1)
Transmit Power Control (TPC)	5.4.4	n.a. (see note 2)	C2 (see note 1)	C3, C4 (see note 1)
Dynamic Frequency Selection (DFS)	5.4.8	n.a. (see note 2)	C5	C6 (see note 3)
Adaptivity	5.4.9	C9		
Receiver Blocking	5.4.10	C7		C8

C1, C3: The lowest declared channel for every declared Nominal Channel Bandwidth within this band. For the Power Density testing, it is sufficient to only perform this test using the lowest Nominal Channel Bandwidth.

C2, C4: The highest declared channel for every declared Nominal Channel Bandwidth within this band. For the Power Density testing, it is sufficient to only perform this test using the lowest Nominal Channel Bandwidth.

C5, C6: One channel out of the declared channels for this frequency range. If more than one Nominal Channel Bandwidth has been declared for this sub-band, testing shall be performed using the lowest and highest Nominal Channel Bandwidth.

C7, C8: One channel out of the declared channels for this sub-band. For Occupied Channel Bandwidth, testing shall be repeated for every declared Nominal Channel Bandwidth within this sub-band.

C9: One channel (in case of single-channel testing) or a group of channels (in case of multi-channel testing) out of the declared channels.

NOTE 1: In case of more than one channel plan has been declared, testing of these specific requirements need only be performed using one of the declared channel plans.

NOTE 2: Testing is not required for Nominal Channel Bandwidths that fall completely within the frequency range 5 150 MHz to 5 250 MHz.

NOTE 3: Where the declared channel plan includes channels whose Nominal Channel Bandwidth falls completely or partly within the 5 600 MHz to 5 650 MHz band, the tests for the Channel Availability Check (and where implemented, for the Off-Channel CAC) shall be performed on one of these channels in addition to a channel within the band 5 470 MHz to 5 600 MHz or within the band 5 650 MHz to 5 725 MHz.

NOTE 4: For Receiver Blocking, just test the channel of smallest channel bandwidth and the lowest data rate.

2.3 DESCRIPTION OF TEST CONDITIONS

E-1
EUT

2.4 DESCRIPTION OF SUPPORT UNITS

The EUT has been tested as an independent unit together with other necessary accessories or support units. The following support units or accessories were used to form a representative test configuration during the tests.

Item	Equipment	Model/Type No.	Series No.	Note
E-1	Mobile Phone	A85	N/A	EUT

Item	Type	Shielded Type	Ferrite Core	Length	Note

Note:

- (1) The support equipment was authorized by Declaration of Confirmation.
- (2) For detachable type I/O cable should be specified the length in cm in 『Length』 column.

2.5 EQUIPMENTS LIST FOR ALL TEST ITEMS

EQUIPMENT TYPE	Manufacturer	Type No.	Serial No.	Last calibration	Calibrated until	Calibration period
EMI Test Receiver	R&S	ESPI7	101318	2022.04.06	2023.04.05	1 year
Bilog Antenna	TESEQ	CBL6111D	31216	2022.03.30	2023.03.29	1 year
Turn Table	EM	SC100_1	60531	N/A	N/A	N/A
Antnna Mast	EM	SC100	N/A	N/A	N/A	N/A
Horn Antenna	EM	EM-AH-10180	2011071402	2022.03.31	2023.03.30	1 year
Horn Ant	Schwarzbeck	BBHA 9170	9170-181	2022.04.01	2023.03.31	1 year
Test Cable (30MHz-1GHz)	N/A	R-01	N/A	2022.06.17	2025.06.16	3 year
Test Cable (1-18GHz)	N/A	R-02	N/A	2022.06.17	2025.06.16	3 year
50Ω Coaxial Switch	Anritsu	MP59B	6200983705	2020.05.11	2023.05.10	3 year
Pre-Amplifier	EMC	EMC051835SE	980246	2022.06.17	2023.06.16	1 year
Spectrum Analyzer	Agilent	E4407B	MY45108040	2022.04.01	2023.03.31	1 year
Filter	TRILTHIC	2400MHz	29	2020.04.07	2023.04.06	3 year
Attenuator	Weinschel	33-10-33	AR4010	2020.04.07	2023.04.06	3 year
Attenuator	Weinschel	24-20-34	BP4485	2020.04.07	2023.04.06	3 year
MXA Signal Analyzer	Agilent	N9020A	MY49100060	2022.06.17	2023.06.16	1 year
ESG VETCTOR SIGNAL GENERAROR	Agilent	E4438C	MY45093347	2022.04.01	2023.03.31	1 year
Power Splitter	Mini-Circuits/ USA	ZN2PD-63-S+	SF025101428	2020.04.07	2023.04.06	3 year
Coupler	Mini-Circuits	ZADC-10-63-S +	SF794101410	2020.04.07	2023.04.06	3 year
Directional Coupler	MCLI/USA	CB11-20	0D2L51502	2020.07.17	2023.07.16	3 year
Attenuator	Agilent	8495B	MY42147029	2020.04.13	2023.04.12	3 year
Power Meter	DARE	RPR3006W	15I00041SNO 84	2022.06.17	2023.06.16	1 year
MXG Vector Signal Generator	Agilent	N5182A	MY47070317	2022.06.16	2023.06.15	1 year
Wideband Radio Communication Tester Specifications	R&S	CMW500	148500	2022.06.16	2023.06.15	1 year
temporary antenna connector (Note)	NTS	R001	N/A	N/A	N/A	N/A

3. CENTRE FREQUENCIES

3.1 APPLIED PROCEDURES / LIMIT

3.1.1 LIMIT

The actual centre frequency for any given channel declared by the manufacturer shall be maintained within the range $f_c \pm 20$ ppm.

3.1.2 TEST PROCEDURES

Test conditions

These measurements shall be performed under both normal and extreme test conditions (see clause 5.1.1).

The channels on which the conformance requirements in clause 4.2 shall be verified are defined in clause 5.1.3.

The UUT shall be configured to operate at a normal RF Output Power level. In addition, the UUT shall be configured to operate on a single channel.

For a UUT with antenna connector(s) and using dedicated external antenna(s), or for a UUT with integral antenna(s) but with a temporary antenna connector(s) provided, conducted measurements shall be used.

In case of conducted measurements on smart antenna systems (devices with multiple transmit chains) the measurements shall be performed on only one of the active transmit chains.

For a UUT with integral antenna(s) and without a temporary antenna connector(s), radiated measurements shall be used.

3.1.3 TEST METHOD

Conducted measurement:

1. Equipment operating without modulation

This test method requires that the UUT can be operated in an unmodulated test mode.

The UUT shall be connected to a frequency counter and operated in an unmodulated mode. The result shall be recorded.

2. Equipment operating with modulation

This method is an alternative to the above method in case the UUT cannot be operated in an un-modulated mode.

The UUT shall be connected to spectrum analyser.

The settings of the spectrum analyser shall be adjusted to optimize the instruments frequency accuracy.

Max Hold shall be selected and the centre frequency adjusted to that of the UUT.

The peak value of the power envelope shall be measured and noted. The span shall be reduced and the marker moved in a positive frequency increment until the upper, (relative to the centre frequency), -10 dBc point is reached. This value shall be noted as f1.

The marker shall then be moved in a negative frequency increment until the lower, (relative to the centre frequency), -10 dBc point is reached. This value shall be noted as f2.

The centre frequency is calculated as $(f1 + f2) / 2$.

Radiated measurement:

The test set up as described in annex B (ETSI EN 301 893 V2.1.1) shall be used with a spectrum analyser of sufficient accuracy attached to the test antenna.

The test procedure is as described under conducted measurement.

3.1.4 TEST SETUP LAYOUT

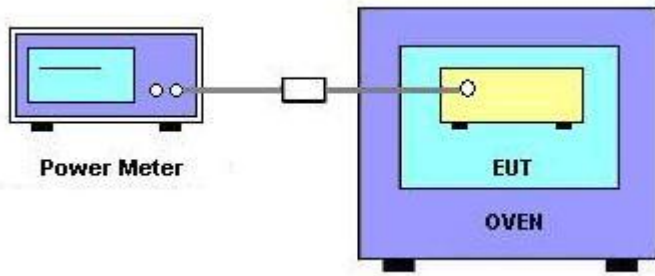

3.1.5 TEST RESULTS

EUT :	Mobile Phone	Model Name :	A85
Temperature :	20 °C	Relative Humidity	54%
Pressure :	1012 hPa	Test Voltage :	DC 3.85V
Test Mode :	Tx Mode-802.11(a/n20/n40/ac20/ac40/ac80)		

802.11a

TEST CONDITIONS				Reference Frequency: 5180MHz			
				fL	fH	(fL+fH)/2	Frequency Deviation (ppm)
T nom (°C)	20	V nom (V)	3.85	5170.69	5189.33	5180.01	1.93
T min (°C)	-10	V nom (V)		5171.58	5188.38	5179.98	-3.86
T max (°C)	40	V nom (V)		5171.00	5188.94	5179.97	-5.79
Limits				± 20 ppm			
Result				Complies			

802.11n20

TEST CONDITIONS				Reference Frequency: 5180MHz			
				fL	fH	(fL+fH)/2	Frequency Deviation (ppm)
T nom (°C)	20	V nom (V)	3.85	5170.10	5189.86	5179.98	-3.86
T min (°C)	-10	V nom (V)		5171.98	5188.06	5180.02	3.86
T max (°C)	40	V nom (V)		5169.12	5190.94	5180.03	5.79
Limits				± 20 ppm			
Result				Complies			

802.11n40

TEST CONDITIONS				Reference Frequency: 5190MHz			
				fL	fH	(fL+fH)/2	Frequency Deviation (ppm)
T nom (°C)	20	V nom (V)	3.85	5171.06	5208.92	5189.99	-1.93
T min (°C)	-10	V nom (V)		5171.69	5208.41	5190.05	9.63
T max (°C)	40	V nom (V)		5170.19	5209.73	5189.96	-7.71
Limits				± 20 ppm			
Result				Complies			

802.11ac20

TEST CONDITIONS				Reference Frequency: 5180MHz			
				fL	fH	(fL+fH)/2	Frequency Deviation (ppm)
T nom (°C)	20	V nom (V)	3.85	5169.59	5190.49	5180.04	7.72
T min (°C)	-10	V nom (V)		5170.51	5189.43	5179.97	-5.79
T max (°C)	40	V nom (V)		5170.04	5189.96	5180.00	0.00
Limits				± 20 ppm			
Result				Complies			

802.11ac40

TEST CONDITIONS				Reference Frequency: 5190MHz			
				fL	fH	(fL+fH)/2	Frequency Deviation (ppm)
T nom (°C)	20	V nom (V)	3.85	5169.95	5209.97	5189.96	-7.71
T min (°C)	-10	V nom (V)		5169.28	5210.66	5189.97	-5.78
T max (°C)	40	V nom (V)		5169.75	5210.25	5190.00	0.00
Limits				± 20 ppm			
Result				Complies			

802.11ac80

TEST CONDITIONS				Reference Frequency: 5210MHz			
				fL	fH	(fL+fH)/2	Frequency Deviation (ppm)
T nom (°C)	20	V nom (V)	3.85	5170.47	5249.57	5210.02	3.84
T min (°C)	-10	V nom (V)		5171.33	5248.73	5210.03	5.76
T max (°C)	40	V nom (V)		5171.93	5248.07	5210.00	0.00
Limits				± 20 ppm			
Result				Complies			

4. NOMINAL CHANNEL BANDWIDTH AND OCCUPIED CHANNEL BANDWIDTH

4.1 APPLIED PROCEDURES / LIMIT

4.1.1 LIMIT

The Nominal Channel Bandwidth shall be at least 5 MHz at all times.

The Occupied Channel Bandwidth shall be between 80 % and 100 % of the declared Nominal Channel Bandwidth. In case of smart antenna systems (devices with multiple transmit chains) each of the transmit chains shall meet this requirement.

NOTE: During an established communication, a device is allowed to operate temporarily in a mode where its Occupied Channel Bandwidth may be reduced to as low as 40 % of its Nominal Channel Bandwidth with a minimum of 4 MHz.

4.1.2 TEST PROCEDURES

Test conditions

The conformance requirements shall be verified only under normal operating conditions, and on those channels and channel bandwidths defined in clause 5.1.3(ETSI EN 301 893 V2.1.1).

The measurements shall be performed using normal operation of the equipment with the test signal applied.

The UUT shall be configured to operate at a typical RF power output level.

When equipment has simultaneous transmissions in adjacent channels, these transmissions may be considered as one signal with an actual Nominal Channel Bandwidth of 'n' times the individual Nominal Channel Bandwidth where 'n' is the number of adjacent channels. When equipment has simultaneous transmissions in non-adjacent channels, each power envelope shall be considered separately.

For a UUT with antenna connector(s) and using dedicated external antenna(s), or for a UUT with integral antenna(s) but with a temporary antenna connector(s) provided, conducted measurements shall be used.

In case of conducted measurements on smart antenna systems (devices with multiple transmit chains) measurements need only to be performed on one of the active transmit chains (antenna outputs).

For a UUT with integral antenna(s) and without a temporary antenna connector(s), radiated measurements shall be used.

4.1.3 TEST METHOD

Conducted measurement

The measurement procedure shall be as follows:

Step 1:

Connect the UUT to the spectrum analyser and use the following settings:

- Centre Frequency: The centre frequency of the channel under test
- Resolution BW: 100 kHz
- Video BW: 300 kHz
- Frequency Span: 2 x Nominal Bandwidth (e.g. 40 MHz for a 20 MHz channel)
- > 1 s; for larger Nominal Bandwidths, the sweep time may be increased until a value where the sweep time has no impact on the RMS value of the signal
- Detector Mode: RMS
- Trace Mode: Max Hold

Step 2:

Wait for the trace to stabilize.

Step 3:

- Make sure that the power envelope is sufficiently above the noise floor of the analyser to avoid the noise signals left and right from the power envelope being taken into account by this measurement.
- Use the 99 % bandwidth function of the spectrum analyser to measure the Occupied Channel Bandwidth of the UUT. This value shall be recorded.

The measurement described in step 1 to step 3 above shall be repeated in case of simultaneous transmissions in non-adjacent channels.

Radiated measurement

The test set up as described in annex B (ETSI EN 301 893 V2.1.1) and the applicable measurement procedures described in annex C (ETSI EN 301 893 V2.1.1) shall be used. The test procedure is as described under conducted measurement.

4.1.4 TEST SETUP LAYOUT

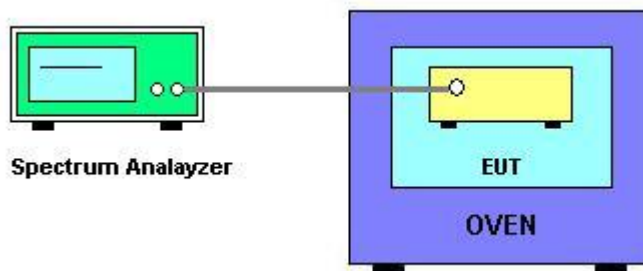

4.1.5 TEST RESULTS

EUT :	Mobile Phone	Model Name :	A85
Temperature :	24°C	Relative Humidity:	54 %
Pressure :	1012 hPa	Test Voltage :	DC 3.85V
Test Mode :	TX Mode-802.11(a/n20/n40/ac20/ac40/ac80)		

Test data reference attachment

5. RF OUTPUT POWER, TRANSMIT POWER CONTROL (TPC) AND POWER DENSITY

5.1 APPLIED PROCEDURES / LIMIT

TPC is not required for channels whose nominal bandwidth falls completely within the band 5 150 MHz to 5 250 MHz.

For devices with TPC, the RF output power and the power density when configured to operate at the highest stated power level of the TPC range shall not exceed the levels given in table 2.

Devices are allowed to operate without TPC. See table 2 for the applicable limits in this case.

Table 2: Mean e.i.r.p. limits for RF output power and power density at the highest power level

Frequency range [MHz]	Mean e.i.r.p. limit [dBm]		Mean e.i.r.p. density limit [dBm/MHz]	
	with TPC	without TPC	with TPC	without TPC
5 150 to 5 350	23	20/23 (see note 1)	10	7/10 (see note 2)
5 470 to 5 725	30 (see note 3)	27 (see note 3)	17 (see note 3)	14 (see note 3)

NOTE 1: The applicable limit is 20 dBm, except for transmissions whose nominal bandwidth falls completely within the band 5 150 MHz to 5 250 MHz, in which case the applicable limit is 23 dBm.

NOTE 2: The applicable limit is 7 dBm/MHz, except for transmissions whose nominal bandwidth falls completely within the band 5 150 MHz to 5 250 MHz, in which case the applicable limit is 10 dBm/MHz.

NOTE 3: Slave devices without a Radar Interference Detection function shall comply with the limits for the band 5 250 MHz to 5 350 MHz.

For devices using TPC, the RF output power during a transmission burst when configured to operate at the lowest stated power level of the TPC range shall not exceed the levels given in table 3. For devices without TPC, the limits in table 3 do not apply.

Table 3: Mean e.i.r.p. limits for RF output power at the lowest power level of the TPC range

Frequency range	Mean e.i.r.p. [dBm]
5 250 MHz to 5 350 MHz	17
5 470 MHz to 5 725 MHz	24 (see note)

NOTE: Slave devices without a Radar Interference Detection function shall comply with the limits for the band 5 250 MHz to 5 350 MHz.

5.2 TEST PROCEDURES

According to ETSI EN 301 893 V2.1.1 (2017-05) §5.4.4

5.3 TEST SETUP LAYOUT

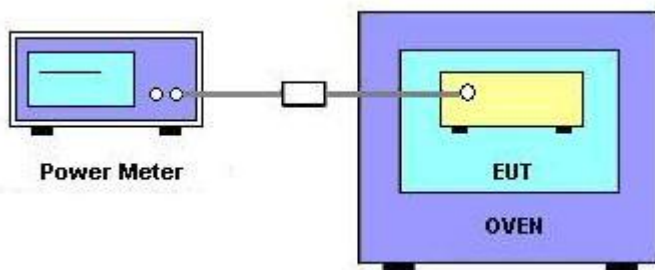

5.4 TEST RESULTS

RF Output Power

EUT :	Mobile Phone	Model Name :	A85
Temperature :	24°C	Relative Humidity:	54 %
Pressure :	1012 hPa	Test Voltage :	DC 3.85V
Test Mode :	Tx Mode-802.11(a/n20/n40/ac20/ac40/ac80)		

Test data reference attachment

Power density

EUT :	Mobile Phone	Model Name :	A85
Temperature :	24°C	Relative Humidity:	54 %
Pressure :	1012 hPa	Test Voltage :	DC 3.85V
Test Mode :	Tx Mode-802.11(a/n20/n40/ac20/ac40/ac80)		

Test data reference attachment

6. TRANSMITTER UNWANTED EMISSIONS OUTSIDE THE 5 GHZ RLAN BANDS

6.1 APPLIED PROCEDURES / LIMIT

The level of transmitter unwanted emissions outside the 5 GHz RLAN bands shall not exceed the limits given in table 4.

In case of equipment with antenna connectors, these limits apply to emissions at the antenna port (conducted) and to the emissions radiated by the cabinet. In case of integral antenna equipment (without temporary antenna connectors), these limits apply to emissions radiated by the equipment

Table 4: Transmitter unwanted emission limits outside the 5 GHz RLAN bands

Frequency range	Maximum power	Bandwidth
30 MHz to 47 MHz	-36 dBm	100 kHz
47 MHz to 74 MHz	-54 dBm	100 kHz
74 MHz to 87,5 MHz	-36 dBm	100 kHz
87,5 MHz to 118 MHz	-54 dBm	100 kHz
118 MHz to 174 MHz	-36 dBm	100 kHz
174 MHz to 230 MHz	-54 dBm	100 kHz
230 MHz to 470 MHz	-36 dBm	100 kHz
470 MHz to 862 MHz	-54 dBm	100 kHz
862 MHz to 1 GHz	-36 dBm	100 kHz
1 GHz to 5,15 GHz	-30 dBm	1 MHz
5,35 GHz to 5,47 GHz	-30 dBm	1 MHz
5,725 GHz to 26 GHz	-30 dBm	1 MHz

6.1.1 CONFORMANCE

Conformance tests as defined in clause 5.4.5 shall be carried out.

6.1.2 TEST RESULTS (30MHz ~ 1000MHz)

EUT :	Mobile Phone	Model Name :	A85
Temperature :	24 °C	Relative Humidity :	57%
Pressure :	1010 hPa	Test Power :	DC 3.85V
Test Mode :	TX-802.11ac80		

Polar (H/V)	Frequency	Meter Reading	Factor	Emission Level	Limits	Margin	Remark
	(MHz)	(dBm)	(dB)	(dBm)	(dBm)	(dB)	
V	46.667	-75.41	14.47	-60.94	-36	-24.94	peak
V	106.847	-86.77	7.22	-79.55	-54	-25.55	peak
V	229.927	-71.6	12.25	-59.35	-36	-23.35	peak
V	414.944	-87.64	13.31	-74.33	-54	-20.33	peak
V	609.59	-74.02	15.91	-58.11	-36	-22.11	peak
V	640.772	-86.52	21.65	-64.87	-54	-10.87	peak
H	39.537	-68.79	18.31	-50.48	-36	-14.48	peak
H	93.288	-84.65	6.20	-78.45	-54	-24.45	peak
H	175.61	-75.69	10.27	-65.42	-36	-29.42	peak
H	342.503	-85.13	12.05	-73.08	-54	-19.08	peak
H	574.156	-73.41	12.93	-60.48	-36	-24.48	peak
H	561.362	-78.61	17.58	-61.03	-54	-7.03	peak

Remark:

Emission Level= Meter Reading+ Factor, Margin= Emission Level - Limit

Note: "802.11ac80" is the worst mode, the test report records only the worst-case test values.

6.1.3 TEST RESULTS (1.0GHz ~26GHz)

EUT :	Mobile Phone	Model Name :	A85
Temperature :	24 °C	Relative Humidity :	54%
Pressure :	1010 hPa	Test Power :	DC 3.85V
Test Mode :	TX-802.11ac20 (CH36/CH40/CH48)		

Polar	Frequency	Meter Reading	Factor	Emission Level	Limits	Margin	Remark
(H/V)	(MHz)	(dBm)	(dB)	(dBm)	(dBm)	(dB)	
operation frequency:5180							
V	10360	-64.41	14.23	-50.18	-30	-20.18	peak
V	15540	-64.84	15.11	-49.73	-30	-19.73	peak
H	10360	-65.73	14.08	-51.65	-30	-21.65	peak
H	15540	-65.21	16.15	-49.06	-30	-19.06	peak
operation frequency:5200							
V	10400	-61.92	13.62	-48.30	-30	-18.30	peak
V	15600	-59.23	16.40	-42.83	-30	-12.83	peak
H	10400	-67.76	14.02	-53.74	-30	-23.74	peak
H	15600	-58.63	15.62	-43.01	-30	-13.01	peak
operation frequency:5240							
V	10480	-60.87	15.21	-45.66	-30	-15.66	peak
V	15720	-58.38	15.37	-43.01	-30	-13.01	peak
H	10480	-64.4	15.29	-49.11	-30	-19.11	peak
H	15720	-61.49	16.55	-44.94	-30	-14.94	peak
Remark:							
Emission Level= Meter Reading+ Factor, Margin= Emission Level - Limit							

Note: "802.11ac20" is the worst mode, the test report records only the worst-case test values.

7. TRANSMITTER UNWANTED EMISSIONS WITHIN THE 5 GHZ RLAN BANDS

7.1 APPLIED PROCEDURES / LIMIT

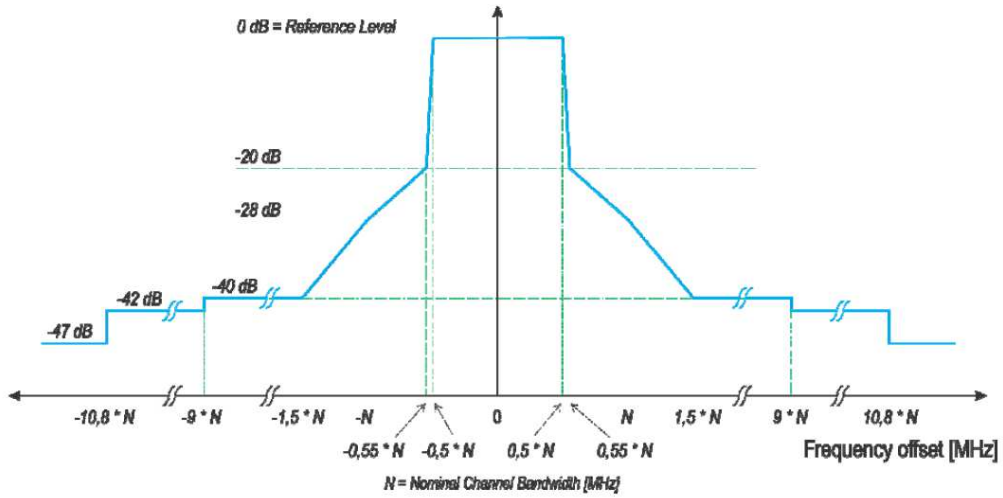

NOTE: dBc is the spectral density relative to the maximum spectral power density of the transmitted signal.

Figure 1: Transmit spectral power mask

7.1.1 TEST PROCEDURES

According to ETSI EN 301 893 V2.1.1 (2017-05) §5.4.6

7.1.2 TEST SETUP LAYOUT

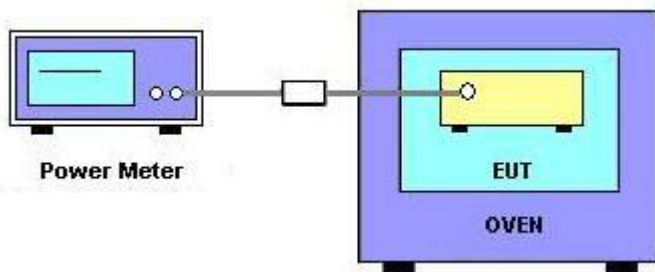

7.1.3 TEST RESULTS

EUT :	Mobile Phone	Model Name :	A85
Temperature :	24°C	Relative Humidity:	54 %
Pressure :	1012 hPa	Test Voltage :	DC 3.85V(NORMAL)
Test Mode :	Tx Mode-802.11(a/n20/n40/ac20/ac40/ac80)		

Test data reference attachment

8. RECEIVER SPURIOUS EMISSIONS

8.1 APPLIED PROCEDURES / LIMIT

The spurious emissions of the receiver shall not exceed the limits given in table 5.

In case of equipment with antenna connectors, these limits apply to emissions at the antenna port (conducted) and to the emissions radiated by the cabinet. In case of integral antenna equipment (without temporary antenna connectors), these limits apply to emissions radiated by the equipment.

Table 5: Spurious radiated emission limits

Frequency range	Maximum power	Measurement bandwidth
30 MHz to 1 GHz	-57 dBm	100 kHz
1 GHz to 26 GHz	-47 dBm	1 MHz

8.1.1 TEST PROCEDURES

According to ETSI EN 301 893 V2.1.1 (2017-05) §5.4.7

8.1.2 TEST SETUP LAYOUT

This test setup layout is the same as that shown in section 6.1.4

8.1.3 TEST RESULTS

EUT :	Mobile Phone	Model Name :	A85
Temperature :	24°C	Relative Humidity :	57 %
Pressure :	1012 hPa	Test Power :	DC 3.85V
Test Mode :	RX-802.11ac20		

BELOW 1G

Polar (H/V)	Frequency	Meter Reading	Factor	Emission Level	Limits	Margin	Remark
	(MHz)	(dBm)	(dB)	(dBm)	(dBm)	(dB)	
V	32.142	-83.38	18.82	-64.56	-57	-7.56	peak
V	107.252	-80.68	11.11	-69.57	-57	-12.57	peak
V	227.456	-77.21	11.41	-65.80	-57	-8.80	peak
V	443.654	-77.97	12.72	-65.25	-57	-8.25	peak
V	640.588	-84.44	12.66	-71.78	-57	-14.78	peak
V	674.289	-84.84	12.62	-72.22	-57	-15.22	peak
H	42.355	-80.89	19.94	-60.95	-57	-3.95	peak
H	95.673	-78.18	10.96	-67.22	-57	-10.22	peak
H	204.76	-79.67	9.42	-70.25	-57	-13.25	peak
H	244.436	-77.35	12.65	-64.70	-57	-7.70	peak
H	502.37	-82.36	11.78	-70.58	-57	-13.58	peak
H	574.185	-79.32	15.38	-63.94	-57	-6.94	peak

Remark:

Emission Level= Meter Reading+ Factor, Margin= Emission Level - Limit

ABOVE 1G

Polar (H/V)	Frequency	Meter Reading	Factor	Emission Level	Limits	Margin	Remark
	(MHz)	(dBm)	(dB)	(dBm)	(dBm)	(dB)	
V	2837.728	-80.91	11.33	-69.58	-47	-22.58	peak
V	3326.46	-84.29	10.97	-73.32	-47	-26.32	peak
V	2891.934	-82.39	10.14	-72.25	-47	-25.25	peak
V	3567.407	-81.76	16.83	-64.93	-47	-17.93	peak
H	2313.475	-81.53	10.52	-71.01	-47	-24.01	peak
H	4451.212	-80.88	11.70	-69.18	-47	-22.18	peak
H	2193.5	-81.08	6.62	-74.46	-47	-27.46	peak
H	4090.503	-82.99	14.99	-68.00	-47	-21.00	peak

Remark:

Emission Level= Meter Reading+ Factor, Margin= Emission Level - Limit

Note: "802.11ac20" is the worst mode, the test report records only the worst-case test values.

9. ADAPTIVITY (CHANNEL ACCESS MECHANISM)

9.1 APPLICABILITY OF ADAPTIVE REQUIREMENTS AND LILIT

This requirement applies to equipment, testing shall be performed using the highest nominal channel Bandwidth. The manufacturer shall state whether the UUT is capable of operating as a Frame Based Equipment or Load Based Equipment. See tables for the applicability of adaptive requirements and limit for each of the operational modes.

Applicability of adaptive requirements and limit

Requirement	Operational Mode		
	Frame Based Equipment	Load Based Equipment (CCA using 'energy detect')	Load Based Equipment (CCA not using any of the mechanisms referenced)
Minimum Clear Channel Assessment (CCA) Time	20 us (see note 1)	(see note 2)	20 us (see note 1)
Maximum Channel Occupancy (COT) Time	1ms to 10 ms	(see note 2)	(13/32)*q ms (see note 3)
Minimum Idle Period	5% of COT	(see note 2)	NA
Extended CCA check	NA	(see note 2)	N*CCA (see note 4)
Short Control Signalling Transmissions	Maximum duty cycle of 5% within an observation period of 50 ms (see note 5)		

Note 1: The CCA time used by the equipment shall be declared by the manufacturer.
 Note 2: LBT based spectrum sharing mechanism based on the Clear Channel Assessment (CCA) mode using 'energy detect', as described in IEEE 802.11™-2007[9], clauses 15 and 17, in IEEE 802.11n™ -2009[10], clauses 20.
 Note 3: q is selected by the manufacturer in the range [4...32]
 Note 4: The value of N shall be randomly selected in the range [1...q]
 Note 5: Adaptive equipment may or may not have Short Control Signaling Transmissions.

Interference threshold level

Maximum transmit power (P _H) EIRP dBm	Threshold Level (TL) (see note 1 and 2)
9.81	-73 dBm / MHz

Note 1: $TL = -73 \text{ dBm / MHz} + (23 - PH) / (1 \text{ MHz})$ (assuming a 0 dBi receive antenna and PH specified in dBm e.i.r.p)
 Note 2: Transmitter the CCA threshold level (TL) shall be equal or lower than -73 dBm / MHz at the input to the receiver (assuming a 0 dBi receive antenna).

TEST PROCEDURE

Reference to ETSI EN 301 893 V2.1.1 (2017-05) clause 5.4.9

9.2 TEST SETUP CONFIGURATION

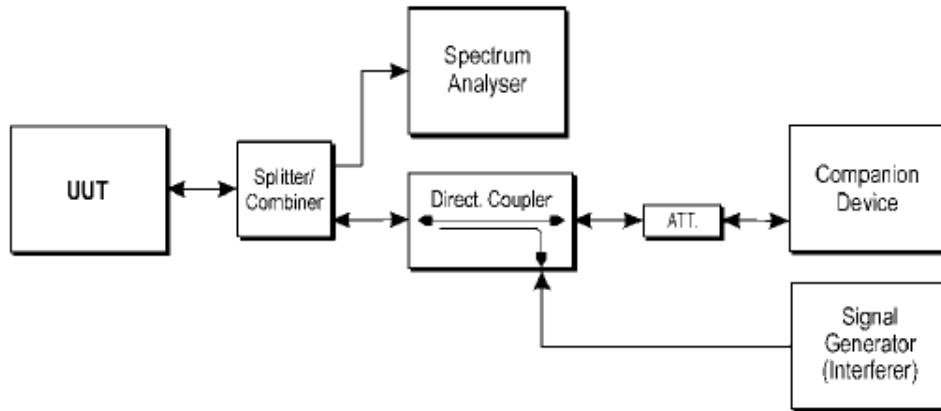

Figure 13: Example Test Set-up for verifying the adaptivity of an equipment

9.3 LIST OF MEASUREMENTS

UUT operational Mode		
Frame Based Equipment	Load Based Equipment (CCA using 'energy detect')	Load Based Equipment (CCA not using any of the mechanisms referenced)
	V	

Clause	Test Parameter	Remarks	PASS/FAIL
4.9.2.1	Adaptive (Frame Based Equipment)	Not Applicable	N/A
4.9.2.2	Adaptive (Load Based Equipment)	Applicable	PASS
4.9.2.3	Short Control Signaling Transmissions	Applicable	PASS

9.4 TEST RESULTS

EUT :	Mobile Phone	Model Name :	A85
Temperature :	24°C	Relative Humidity :	54 %
Pressure :	1012 hPa	Test Power :	DC 3.85V
TEST RESULTS	Pass		

Test data reference attachment

10. RECEIVER BLOCKING

10.1 LIMITS OF RECEIVER BLOCKING

Performance Criteria

The minimum performance criterion shall be a PER of less than or equal to 10 %. The manufacturer may declare alternative performance criteria as long as that is appropriate for the intended use of the equipment (see clause 5.4.1, item s)).

While maintaining the minimum performance criteria as defined in clause 4.2.8.3, the blocking levels at specified frequency offsets shall be equal to or greater than the limits defined in table 7.

Table 9: Receiver Blocking parameters

Wanted signal mean power from companion device (dBm)	Blocking signal Frequency (MHz)	Blocking signal power (dBm) (see note 2)	Type of blocking signal
P _{min} + 6 dB	5 100	-59	CW
P _{min} + 6 dB	4 900 5 000 5 975	-53	CW

NOTE 1: P_{min} is the minimum level of the wanted signal (in dBm) required to meet the minimum performance criteria as defined clause 4.2.8.3 in the absence of any blocking signal.

NOTE 2: The levels specified are levels in front of the UUT antenna. In case of conducted measurements, the same levels should be used at the antenna connector irrespective of antenna gain.

10.2 TEST PROCEDURE

Refer to chapter 5.4.10 of ETSI EN 301 893 V2.1.1 (2017-05)

Measurement	
<input checked="" type="checkbox"/> Conducted measurement	<input type="checkbox"/> Radiated measurement

10.3 DEVIATION FROM TEST STANDARD

No deviation

10.4 TEST SETUP

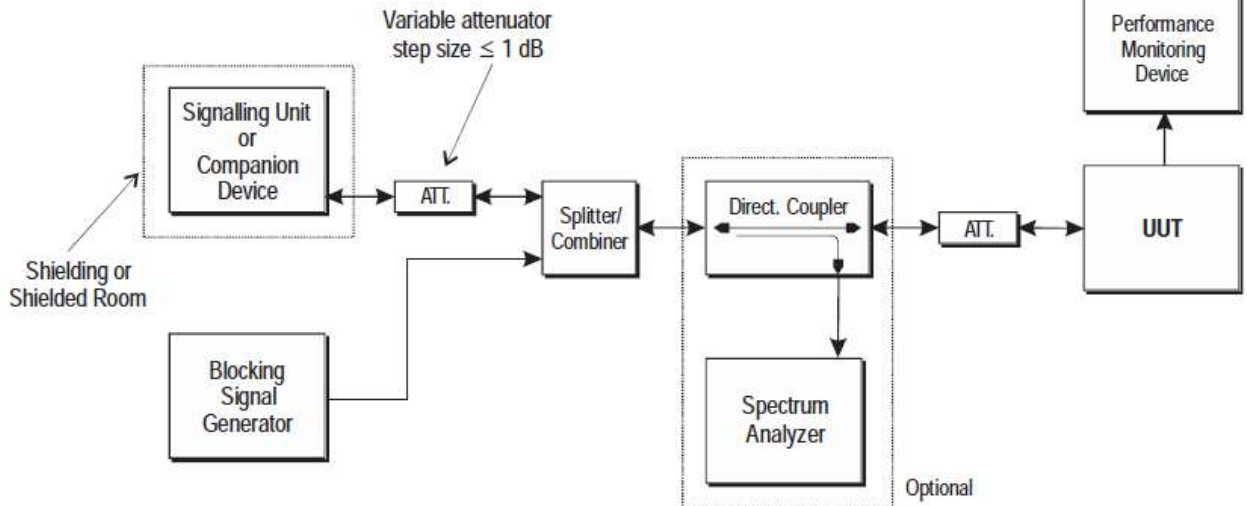

Figure 14: Test Set-up for receiver blocking

10.5 TEST RESULTS

EUT :	Mobile Phone	Model Number :	A85
Temperature :	24°C	Relative Humidity :	54 %
Pressure :	1012 hPa	Test Voltage :	DC 3.85V
Test Mode :	RX 802.11a		

CH 36-5180MHz

Wanted signal mean power from companion device (dBm) <small>Note(1)</small>	Blocking signal Frequency (MHz)	Blocking signal power (dBm)	PER % <small>Note(1)</small>	PER Limit %
-72 + 6 dB	5100	-59	0.2	≤10%
-72 + 6 dB	4900	-53	0.17	≤10%
	5000		0.22	
	5975		0.74	

CH 48-5240MHz

Wanted signal mean power from companion device (dBm) <small>Note(1)</small>	Blocking signal Frequency (MHz)	Blocking signal power (dBm)	PER % <small>Note(1)</small>	PER Limit %
-72 + 6 dB	5100	-59	0.52	≤10%
-72 + 6 dB	4900	-53	0.63	≤10%
	5000		0.84	
	5975		0.33	

Note: (1) The above results were obtained from laboratory tests.

11. USER ACCESS RESTRICTIONS

11.1 APPLIED PROCEDURES / LIMIT

The equipment shall be so constructed that settings (hardware and/or software) related to DFS shall not be accessible to the user if changing those settings result in the equipment no longer being compliant with the DFS requirements in clause 4.2.6.

The above requirement includes the prevention of indirect access to any setting that impacts DFS. The following is a non-exhaustive list of examples of such indirect access.

11.2 TEST RESULTS

The EUT is accord with User Access Restrictions

12. GEO-LOCATION CAPABILITY

12.1 APPLIED PROCEDURES / LIMIT

The geographic location determined by the equipment as defined in clause 4.2.10.2 shall not be accessible to the user.

If the equipment cannot determine the geographic location, it shall operate in a mode compliant with the requirements applicable in any of the geographic locations where the equipment is intended to operate.

12.2 TEST RESULTS

The EUT is accord with Geo-location capability

13 TEST RESULTS

13.1 Occupied Channel Bandwidth

Condition	Mode	Frequency (MHz)	Antenna	Center Frequency (MHz)	OBW (MHz)	Verdict
NVNT	a	5180	Ant1	5179.972	16.43	Pass
NVNT	n20	5180	Ant1	5179.968	17.598	Pass
NVNT	n40	5190	Ant1	5189.916	36.18	Pass
NVNT	ac20	5180	Ant1	5179.966	17.594	Pass
NVNT	ac40	5190	Ant1	5189.916	36.18	Pass
NVNT	ac80	5210	Ant1	5209.952	75.768	Pass

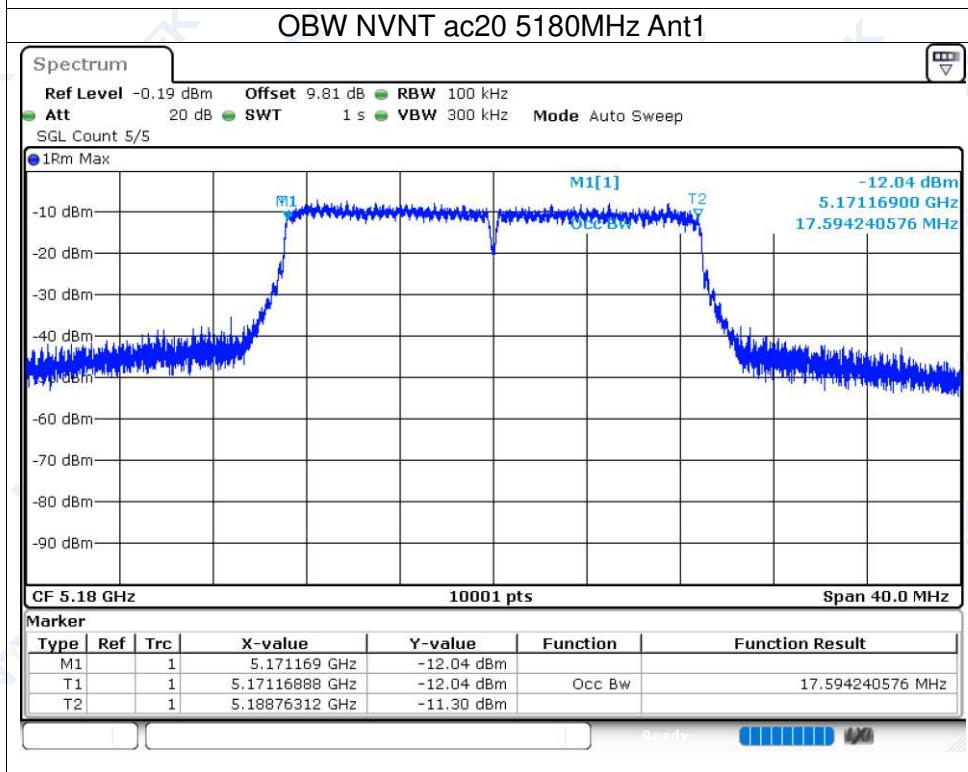
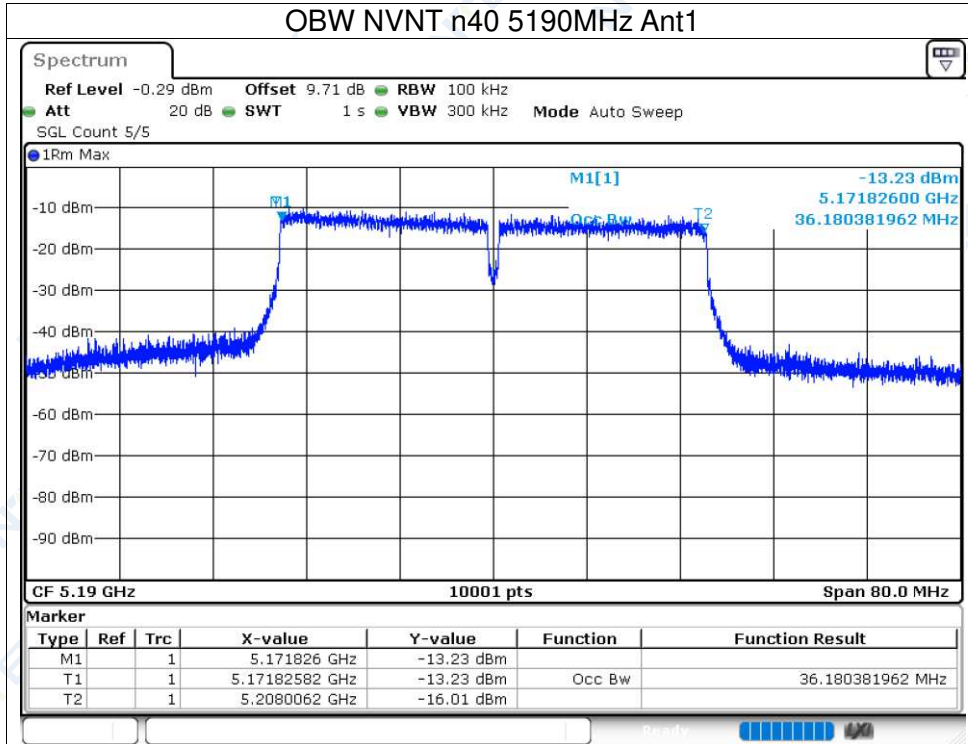

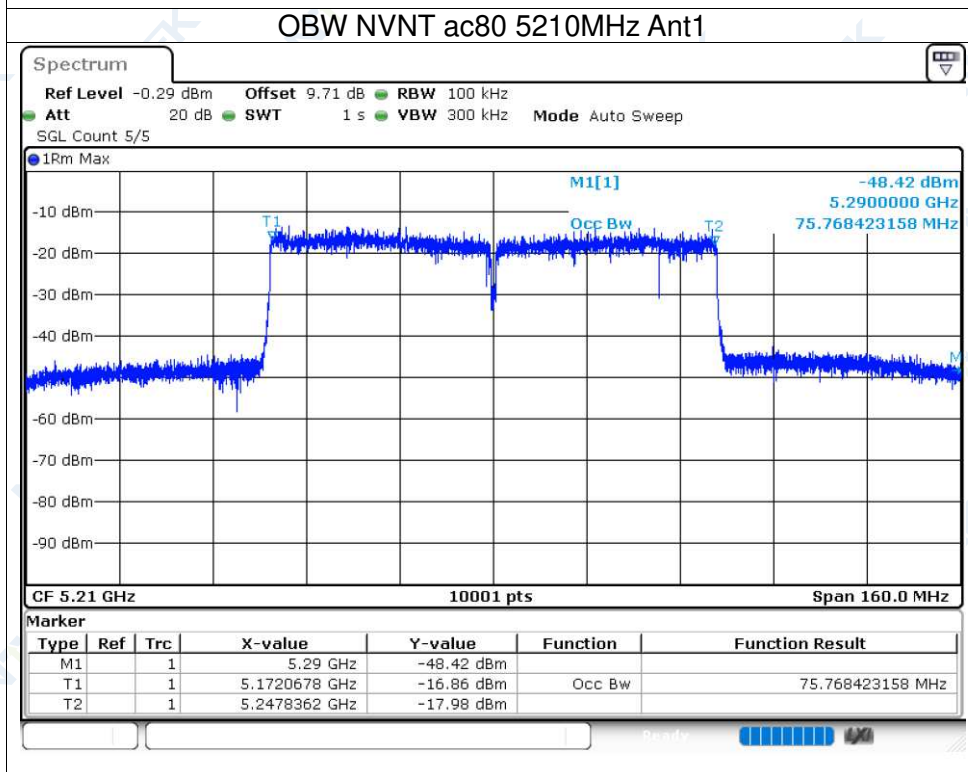
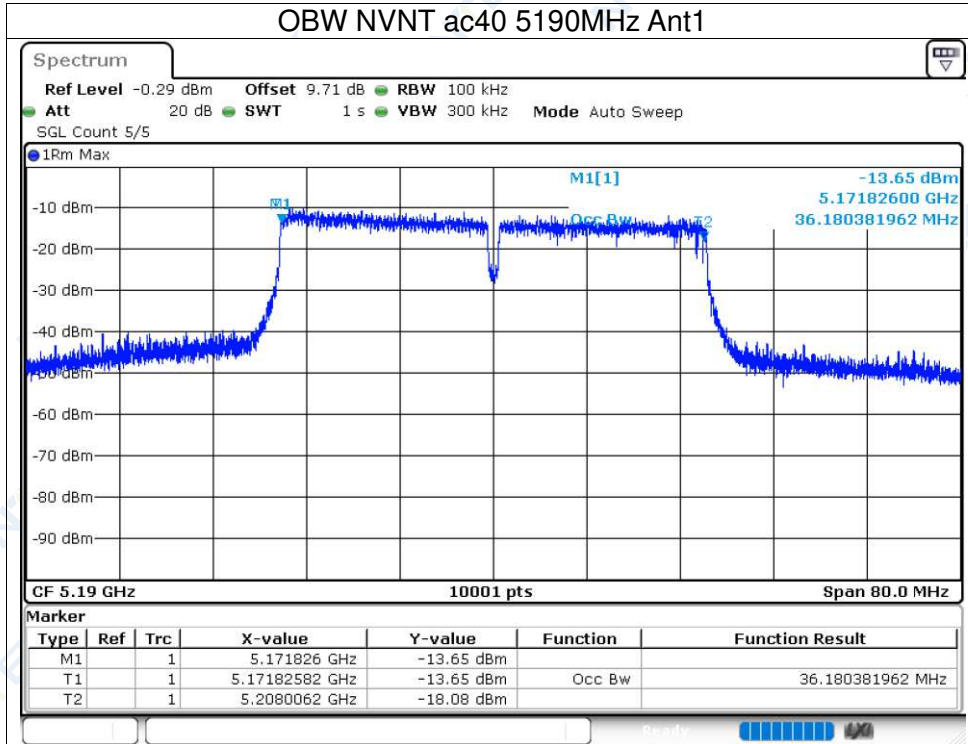

13.2 RF Output Power

Condition	Mode	Frequency (MHz)	Antenna	Max Burst RMS Power (dBm)	Burst Number	Max EIRP (dBm)	Limit (dBm)	Verdict
NVNT	a	5180	Ant1	8.86	66	9.43	23	Pass
NVNT	n20	5180	Ant1	8.85	77	9.42	23	Pass
NVNT	n40	5190	Ant1	9.14	138	9.71	23	Pass
NVNT	ac20	5180	Ant1	9.06	85	9.63	23	Pass
NVNT	ac40	5190	Ant1	9.12	136	9.69	23	Pass
NVNT	ac80	5210	Ant1	9.23	224	9.8	23	Pass
NVLT	a	5180	Ant1	8.82	66	9.39	23	Pass
NVLT	n20	5180	Ant1	8.70	77	9.27	23	Pass
NVLT	n40	5190	Ant1	9.14	138	9.71	23	Pass
NVLT	ac20	5180	Ant1	9.03	85	9.60	23	Pass
NVLT	ac40	5190	Ant1	9.04	136	9.61	23	Pass
NVLT	ac80	5210	Ant1	9.21	224	9.78	23	Pass
NVHT	a	5180	Ant1	8.77	66	9.34	23	Pass
NVHT	n20	5180	Ant1	8.76	77	9.33	23	Pass
NVHT	n40	5190	Ant1	9.00	138	9.57	23	Pass
NVHT	ac20	5180	Ant1	8.96	85	9.53	23	Pass
NVHT	ac40	5190	Ant1	9.07	136	9.64	23	Pass
NVHT	ac80	5210	Ant1	9.20	224	9.77	23	Pass

Test Graphs
Power NVNT a 5180MHz Ant1

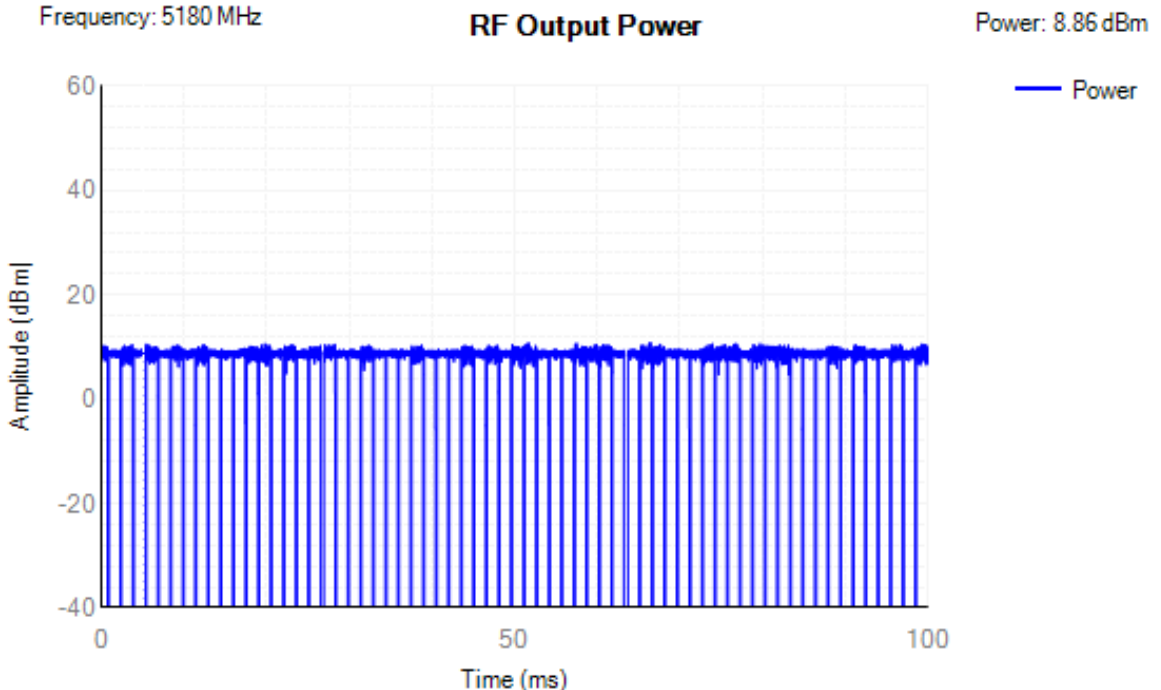

Power NVNT n20 5180MHz Ant1

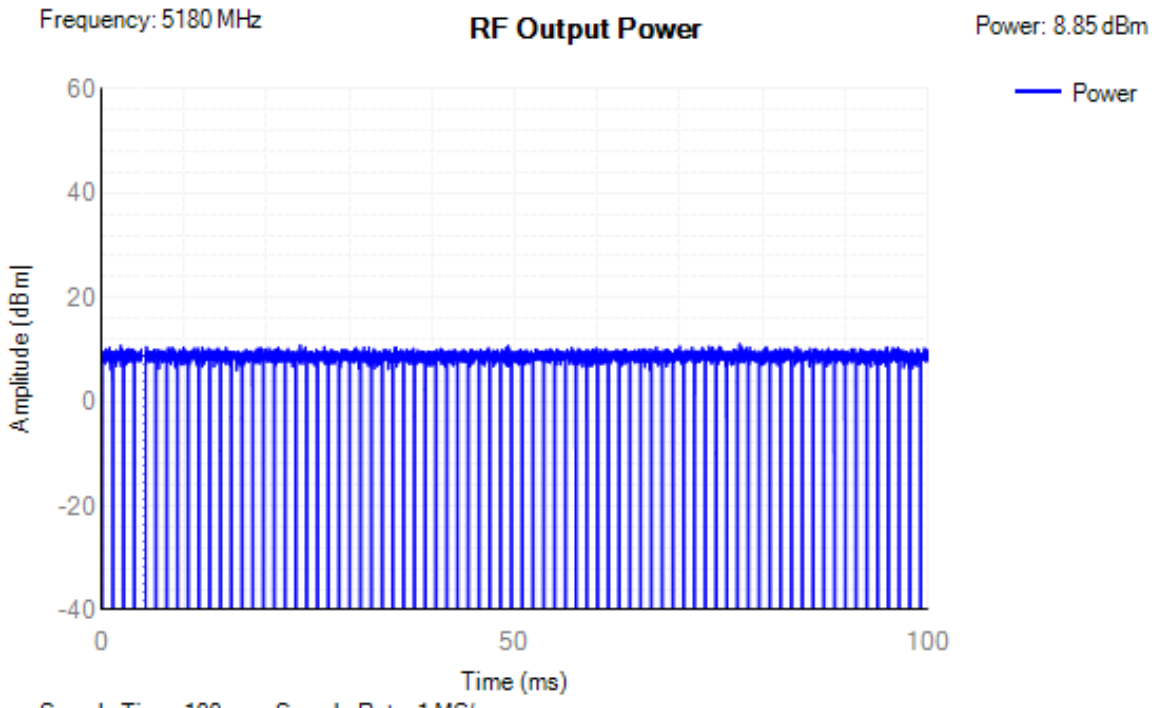

Power NVNT n40 5190MHz Ant1

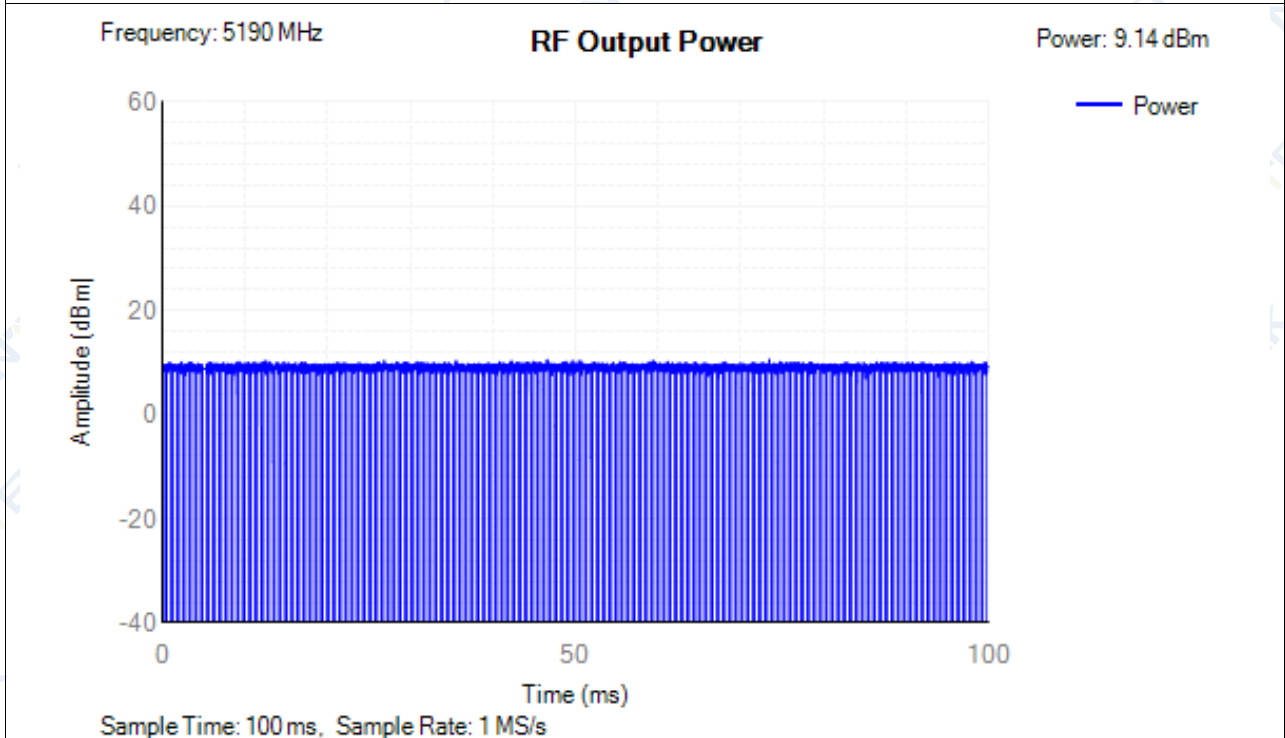

Power NVNT ac20 5180MHz Ant1

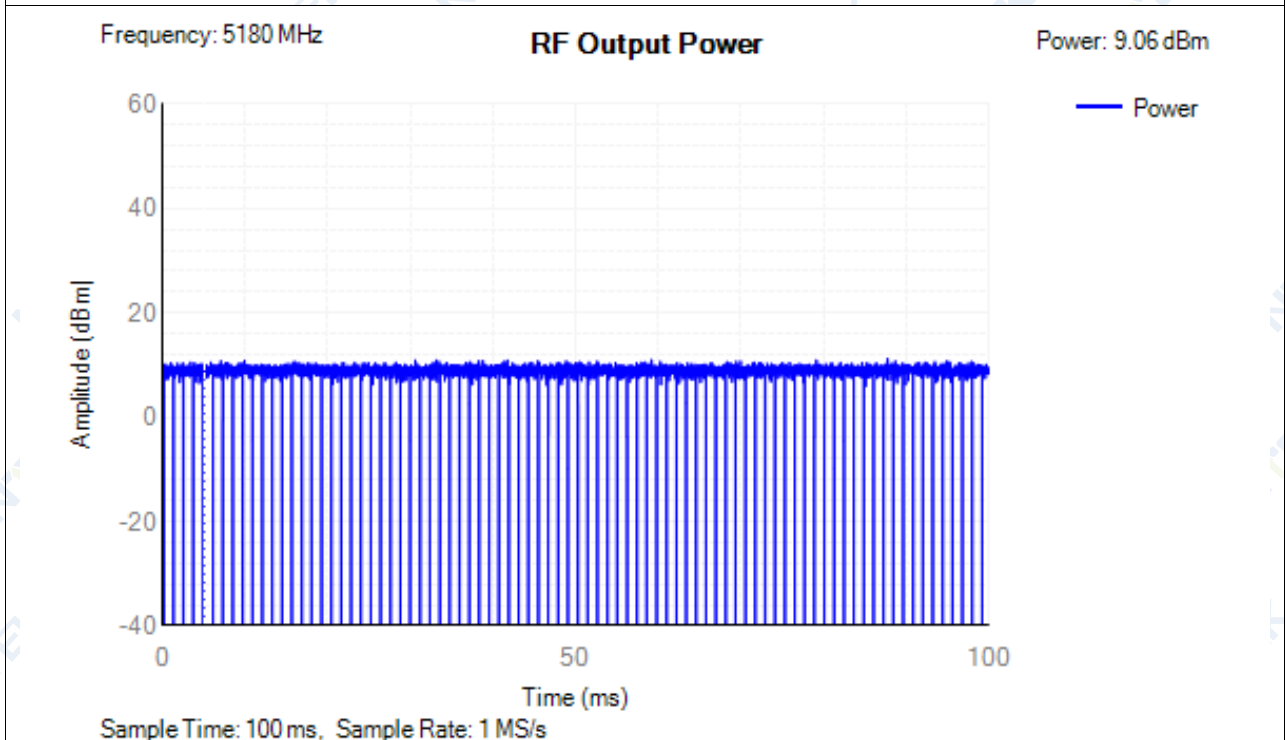

Power NVNT ac40 5190MHz Ant1

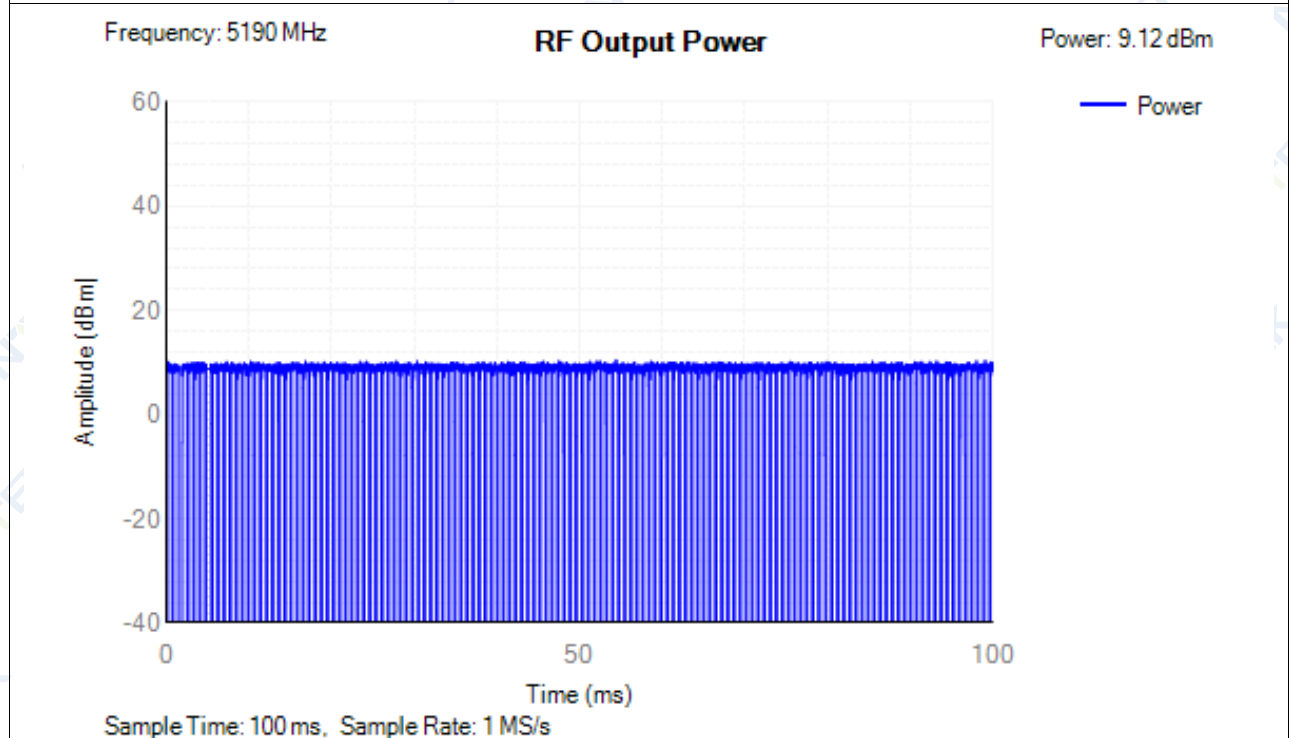

Power NVNT ac80 5210MHz Ant1

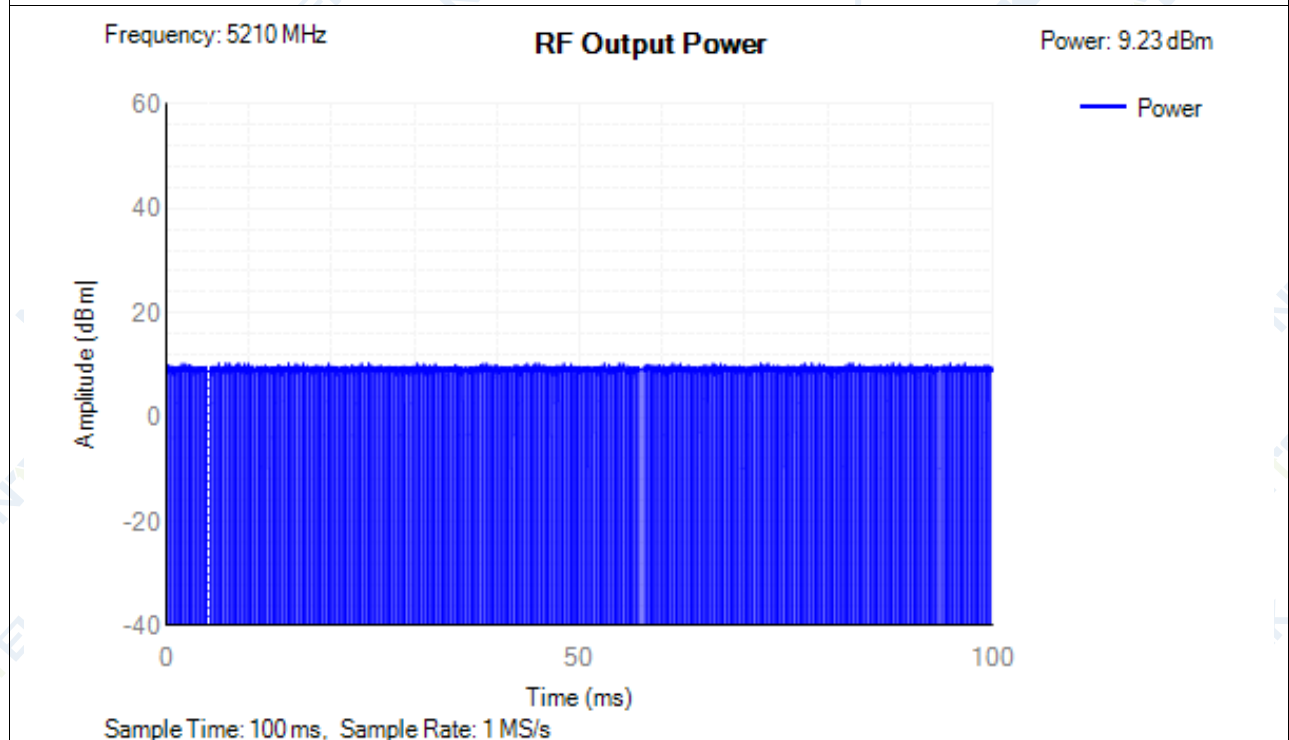

13.3 Power Spectral Density

Condition	Mode	Frequency (MHz)	Antenna	Max PSD (dBm/MHz)	Limit (dBm/MHz)	Verdict
NVNT	a	5180	Ant1	-2.62	10	Pass
NVNT	n20	5180	Ant1	-2.87	10	Pass
NVNT	n40	5190	Ant1	-4.82	10	Pass
NVNT	ac20	5180	Ant1	-2.7	10	Pass
NVNT	ac40	5190	Ant1	-4.86	10	Pass
NVNT	ac80	5210	Ant1	-8.56	10	Pass

Test Graphs

PSD NVNT a 5180MHz Ant1

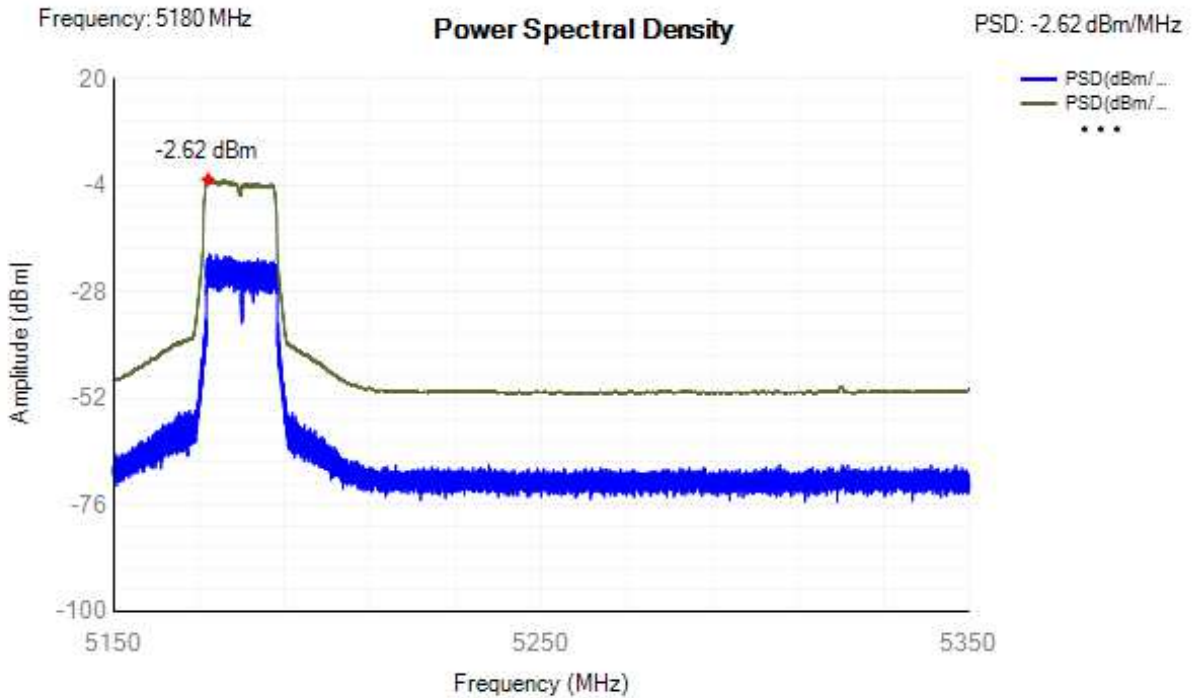

PSD NVNT n20 5180MHz Ant1

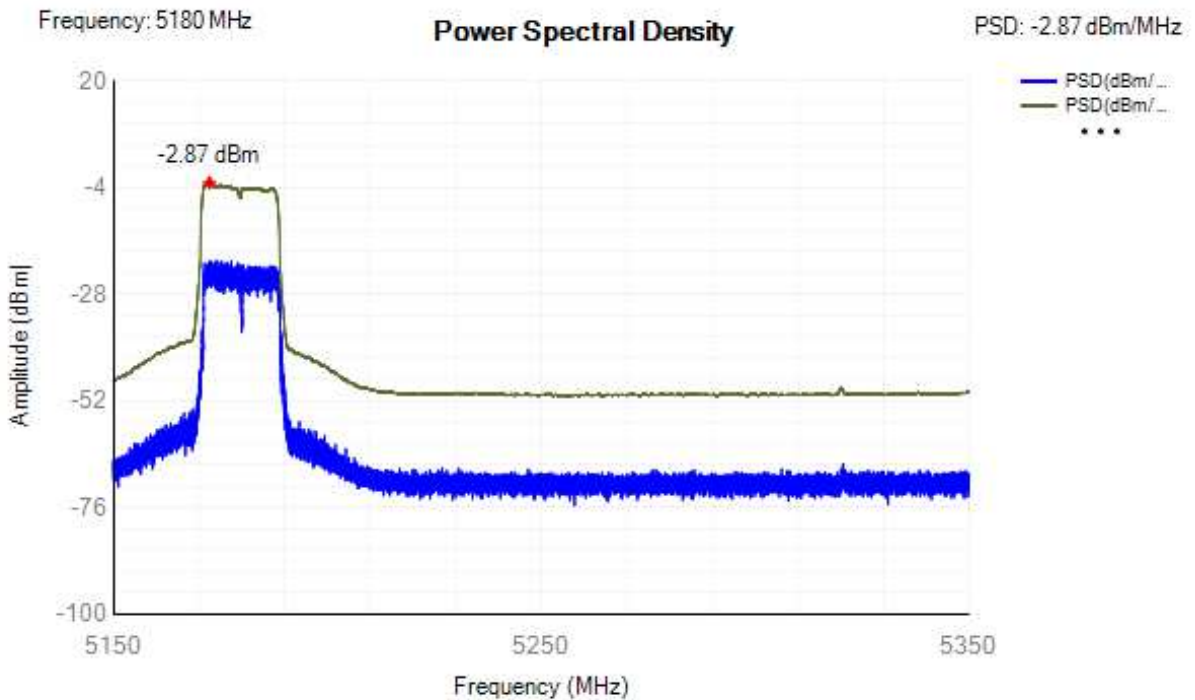

PSD NVNT n40 5190MHz Ant1

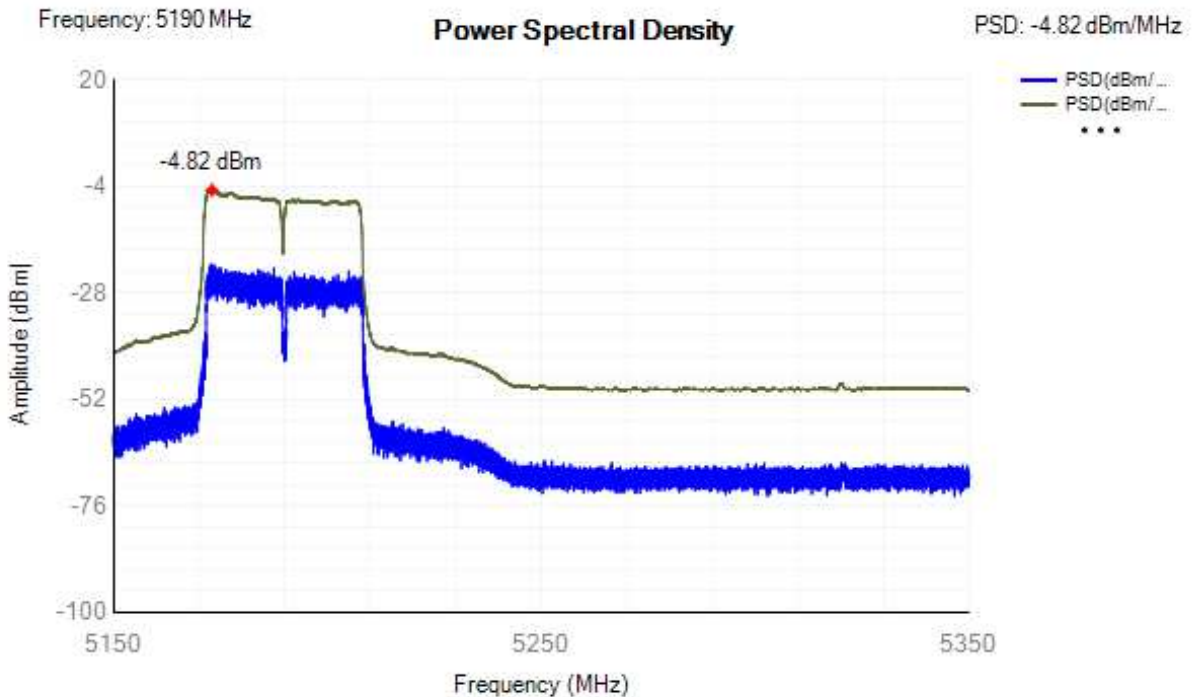

PSD NVNT ac20 5180MHz Ant1

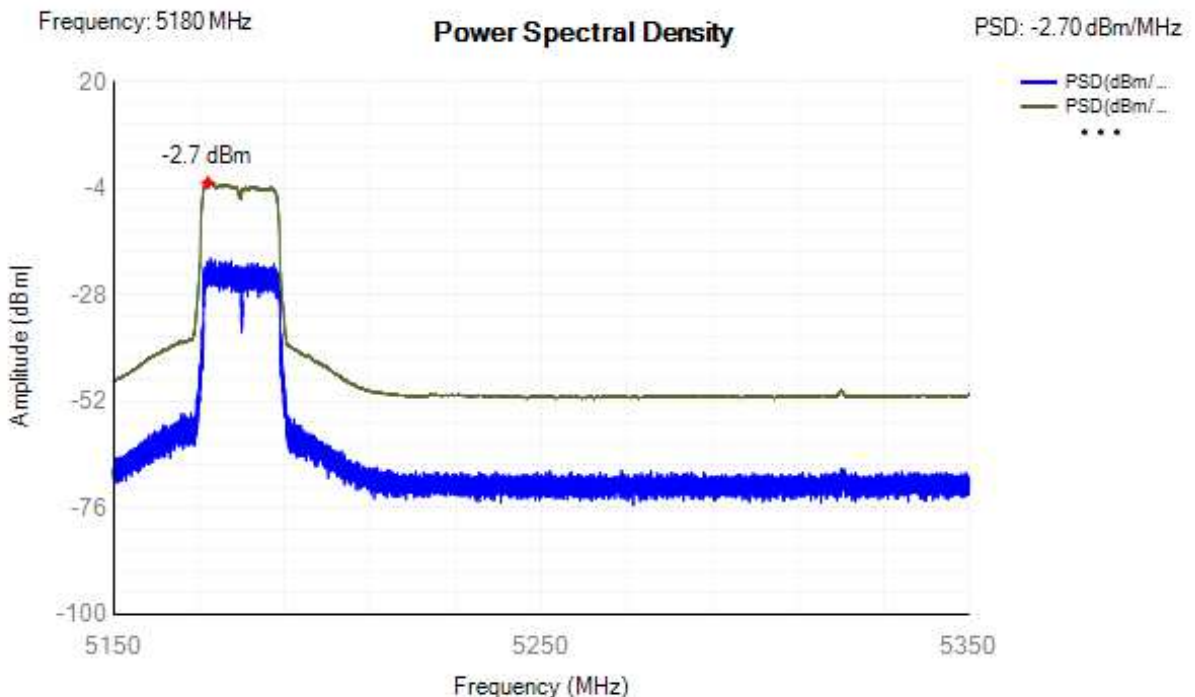

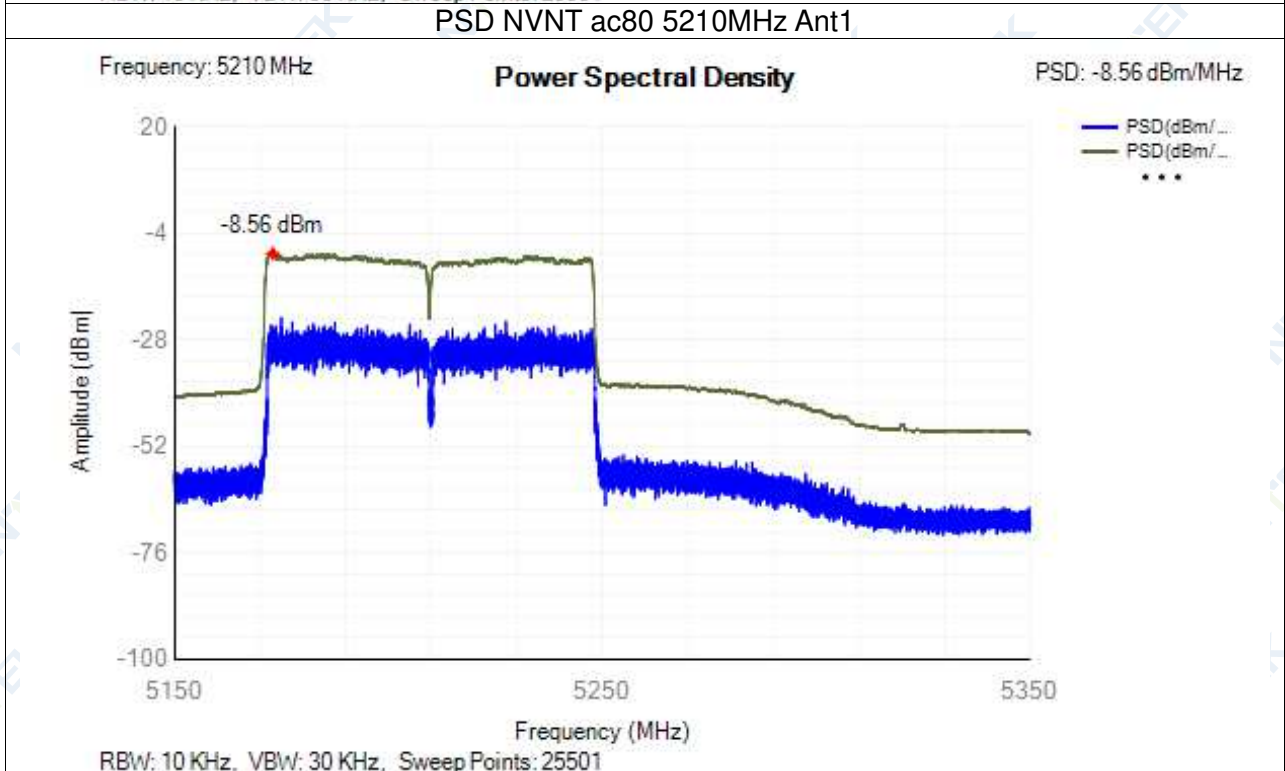
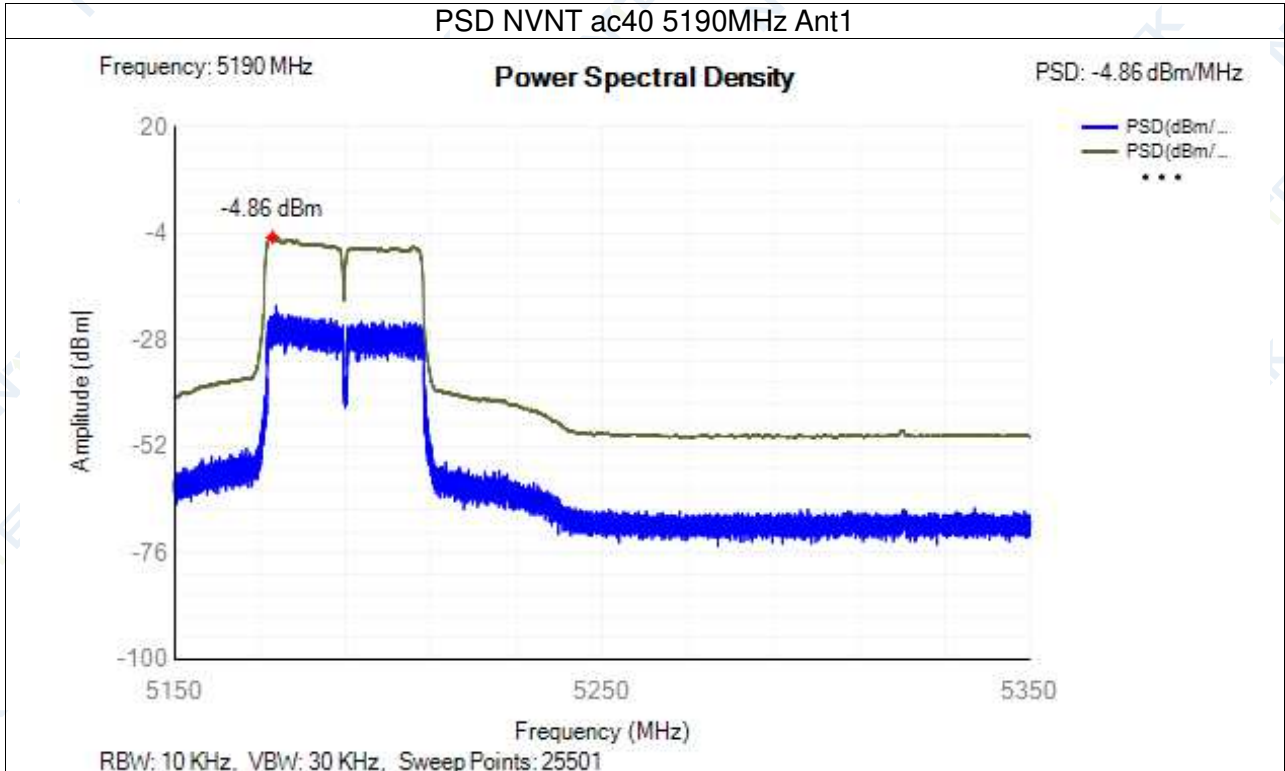

13.4 Transmitter unwanted emissions in the spurious domain

Condition	Mode	Frequency (MHz)	Antenna	Range (MHz)	Spur Freq (MHz)	Peak (dBm)	RMS (dBm)	Limit (dBm)	Verdict
NVNT	a	5180	Ant1	30 -47	38.00	-76.30	NA	-36	Pass
NVNT	a	5180	Ant1	47 -74	51.50	-75.94	NA	-54	Pass
NVNT	a	5180	Ant1	74 -87.5	87.00	-75.28	NA	-36	Pass
NVNT	a	5180	Ant1	87.5 -118	97.00	-75.36	NA	-54	Pass
NVNT	a	5180	Ant1	118 -174	151.80	-75.59	NA	-36	Pass
NVNT	a	5180	Ant1	174 -230	178.30	-74.95	NA	-54	Pass
NVNT	a	5180	Ant1	230 -470	292.40	-74.48	NA	-36	Pass
NVNT	a	5180	Ant1	470 -862	533.80	-73.93	NA	-54	Pass
NVNT	a	5180	Ant1	862 -1000	972.90	-66.11	NA	-36	Pass
NVNT	a	5180	Ant1	1000 -5150	5149.00	-35.81	-37.71	-30	Pass
NVNT	a	5180	Ant1	5350 -5470	5429.00	-48.92	NA	-30	Pass
NVNT	a	5180	Ant1	5725 -26000	17675.00	-43.63	NA	-30	Pass
NVNT	n20	5180	Ant1	30 -47	33.80	-75.38	NA	-36	Pass
NVNT	n20	5180	Ant1	47 -74	68.20	-74.77	NA	-54	Pass
NVNT	n20	5180	Ant1	74 -87.5	85.40	-75.72	NA	-36	Pass
NVNT	n20	5180	Ant1	87.5 -118	110.90	-74.89	NA	-54	Pass
NVNT	n20	5180	Ant1	118 -174	172.50	-74.42	NA	-36	Pass
NVNT	n20	5180	Ant1	174 -230	179.00	-74.40	NA	-54	Pass
NVNT	n20	5180	Ant1	230 -470	249.70	-73.64	NA	-36	Pass
NVNT	n20	5180	Ant1	470 -862	836.30	-74.29	NA	-54	Pass
NVNT	n20	5180	Ant1	862 -1000	974.50	-63.93	NA	-36	Pass
NVNT	n20	5180	Ant1	1000 -5150	5149.00	-28.80	-33.37	-30	Pass
NVNT	n20	5180	Ant1	5350 -5470	5416.00	-47.75	NA	-30	Pass
NVNT	n20	5180	Ant1	5725 -26000	16747.00	-43.78	NA	-30	Pass
NVNT	n40	5190	Ant1	30 -47	45.30	-74.85	NA	-36	Pass
NVNT	n40	5190	Ant1	47 -74	71.90	-75.45	NA	-54	Pass
NVNT	n40	5190	Ant1	74 -87.5	79.10	-75.68	NA	-36	Pass
NVNT	n40	5190	Ant1	87.5 -118	94.10	-74.89	NA	-54	Pass
NVNT	n40	5190	Ant1	118 -174	141.00	-74.95	NA	-36	Pass
NVNT	n40	5190	Ant1	174 -230	184.80	-74.37	NA	-54	Pass
NVNT	n40	5190	Ant1	230 -470	343.90	-74.34	NA	-36	Pass
NVNT	n40	5190	Ant1	470 -862	834.20	-74.20	NA	-54	Pass

NVNT	n40	5190	Ant1	862 -1000	984.40	-64.81	NA	-36	Pass
NVNT	n40	5190	Ant1	1000 -5150	5149.00	-24.94	-30.49	-30	Pass
NVNT	n40	5190	Ant1	5350 -5470	5408.00	-48.31	NA	-30	Pass
NVNT	n40	5190	Ant1	5725 -26000	16264.00	-43.14	NA	-30	Pass
NVNT	ac20	5180	Ant1	30 -47	32.00	-76.21	NA	-36	Pass
NVNT	ac20	5180	Ant1	47 -74	71.20	-75.12	NA	-54	Pass
NVNT	ac20	5180	Ant1	74 -87.5	76.00	-75.78	NA	-36	Pass
NVNT	ac20	5180	Ant1	87.5 -118	106.00	-74.93	NA	-54	Pass
NVNT	ac20	5180	Ant1	118 -174	158.60	-75.33	NA	-36	Pass
NVNT	ac20	5180	Ant1	174 -230	200.40	-74.50	NA	-54	Pass
NVNT	ac20	5180	Ant1	230 -470	358.40	-74.32	NA	-36	Pass
NVNT	ac20	5180	Ant1	470 -862	619.30	-74.15	NA	-54	Pass
NVNT	ac20	5180	Ant1	862 -1000	974.50	-63.56	NA	-36	Pass
NVNT	ac20	5180	Ant1	1000 -5150	5149.00	-34.52	-33.56	-30	Pass
NVNT	ac20	5180	Ant1	5350 -5470	5393.00	-47.94	NA	-30	Pass
NVNT	ac20	5180	Ant1	5725 -26000	16675.00	-43.81	NA	-30	Pass
NVNT	ac40	5190	Ant1	30 -47	39.30	-75.89	NA	-36	Pass
NVNT	ac40	5190	Ant1	47 -74	62.20	-74.03	NA	-54	Pass
NVNT	ac40	5190	Ant1	74 -87.5	80.20	-75.88	NA	-36	Pass
NVNT	ac40	5190	Ant1	87.5 -118	109.20	-75.13	NA	-54	Pass
NVNT	ac40	5190	Ant1	118 -174	152.50	-73.69	NA	-36	Pass
NVNT	ac40	5190	Ant1	174 -230	205.70	-74.11	NA	-54	Pass
NVNT	ac40	5190	Ant1	230 -470	238.50	-74.10	NA	-36	Pass
NVNT	ac40	5190	Ant1	470 -862	694.80	-73.96	NA	-54	Pass
NVNT	ac40	5190	Ant1	862 -1000	984.40	-66.11	NA	-36	Pass
NVNT	ac40	5190	Ant1	1000 -5150	5148.00	-27.37	-30.33	-30	Pass
NVNT	ac40	5190	Ant1	5350 -5470	5467.00	-48.01	NA	-30	Pass
NVNT	ac40	5190	Ant1	5725 -26000	22788.00	-43.28	NA	-30	Pass
NVNT	ac80	5210	Ant1	30 -47	41.90	-75.98	NA	-36	Pass
NVNT	ac80	5210	Ant1	47 -74	60.00	-74.48	NA	-54	Pass
NVNT	ac80	5210	Ant1	74 -87.5	77.40	-75.37	NA	-36	Pass
NVNT	ac80	5210	Ant1	87.5 -118	110.50	-75.46	NA	-54	Pass
NVNT	ac80	5210	Ant1	118 -174	157.00	-75.08	NA	-36	Pass
NVNT	ac80	5210	Ant1	174 -230	211.60	-74.75	NA	-54	Pass
NVNT	ac80	5210	Ant1	230 -470	265.50	-74.04	NA	-36	Pass

NVNT	ac80	5210	Ant1	470 -862	662.30	-73.73	NA	-54	Pass
NVNT	ac80	5210	Ant1	862 -1000	988.80	-70.26	NA	-36	Pass
NVNT	ac80	5210	Ant1	1000 -5150	5147.00	-28.95	-32.22	-30	Pass
NVNT	ac80	5210	Ant1	5350 -5470	5361.00	-47.86	NA	-30	Pass
NVNT	ac80	5210	Ant1	5725 -26000	22796.00	-43.73	NA	-30	Pass

Test Graphs

Tx. Spurious NVNT a 5180MHz Ant1

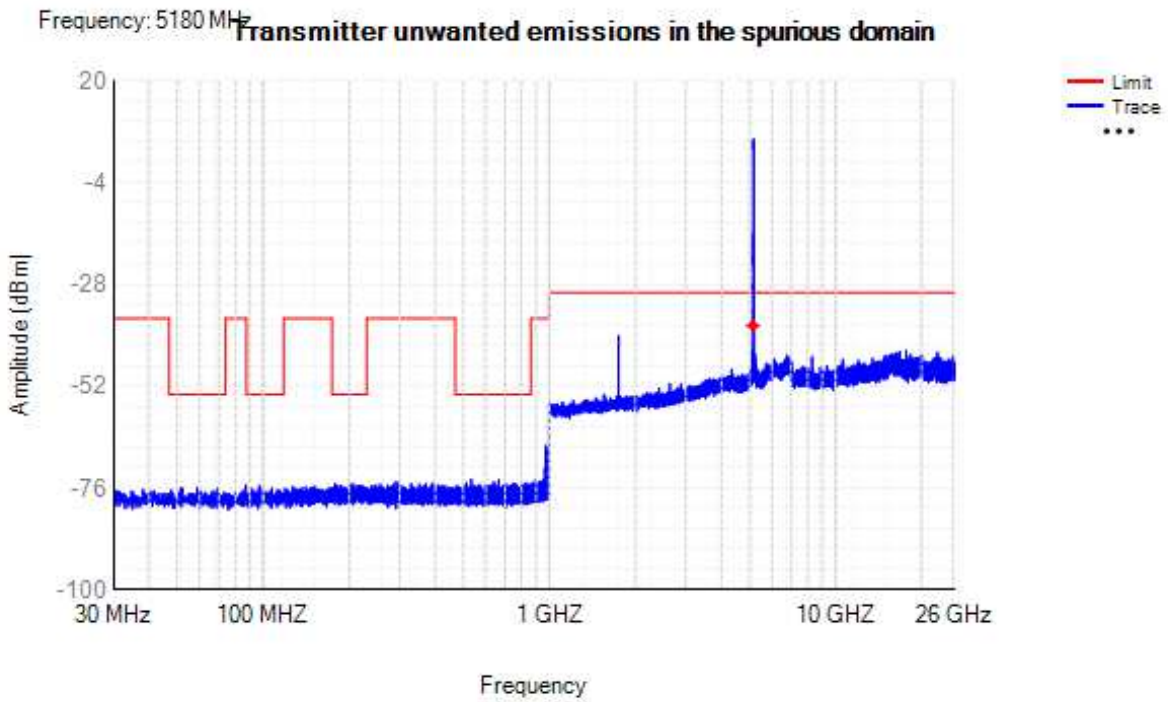

Tx. Spurious NVNT n20 5180MHz Ant1

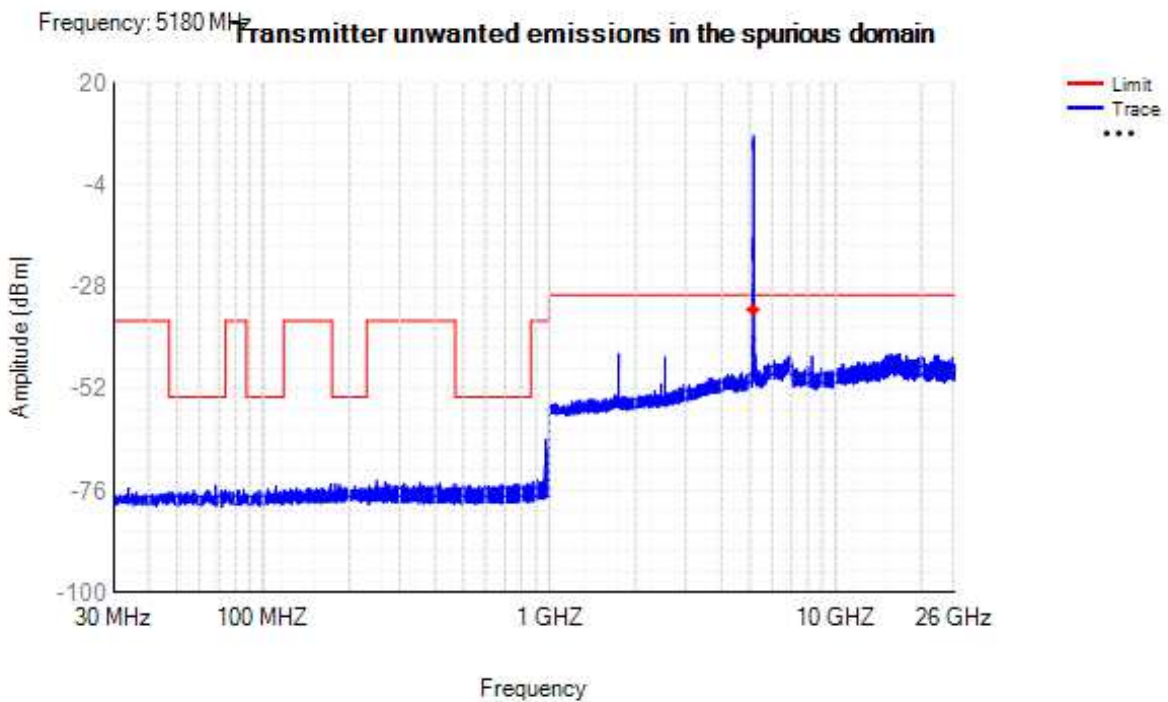

Tx. Spurious NVNT n40 5190MHz Ant1

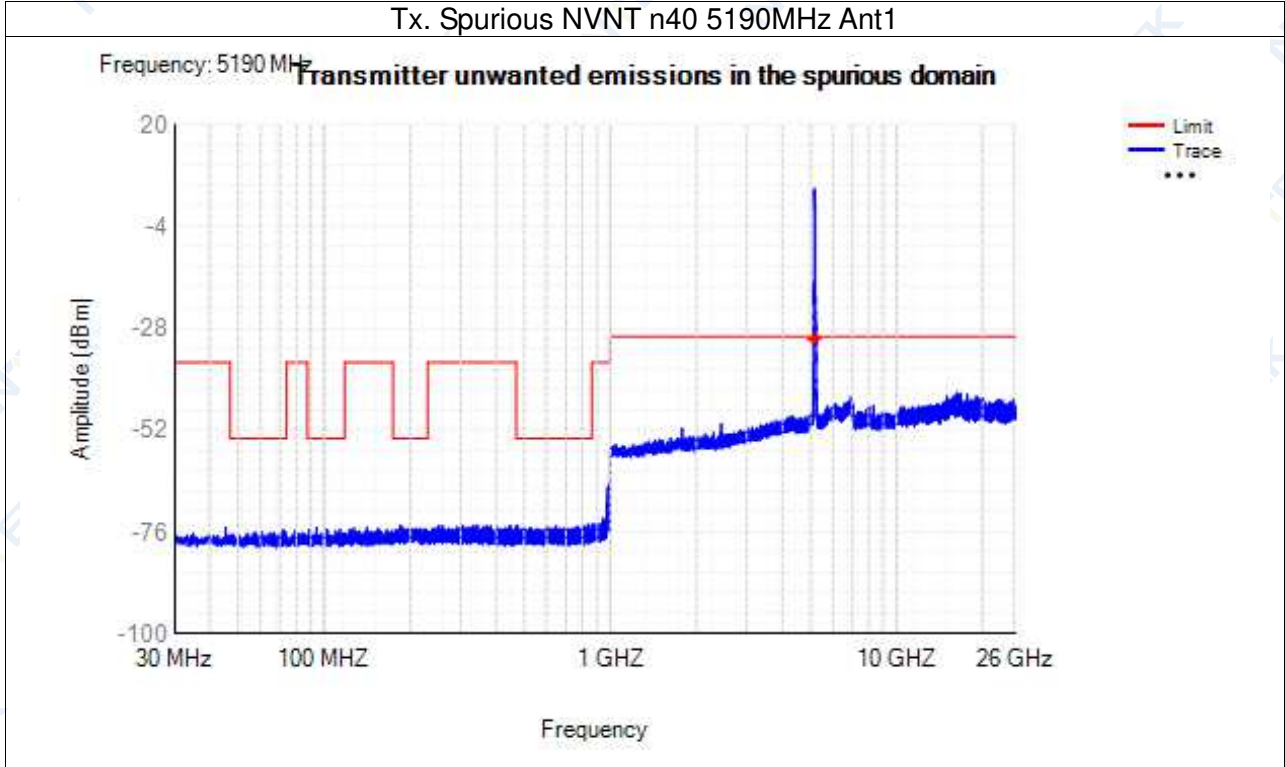

Tx. Spurious NVNT ac20 5180MHz Ant1

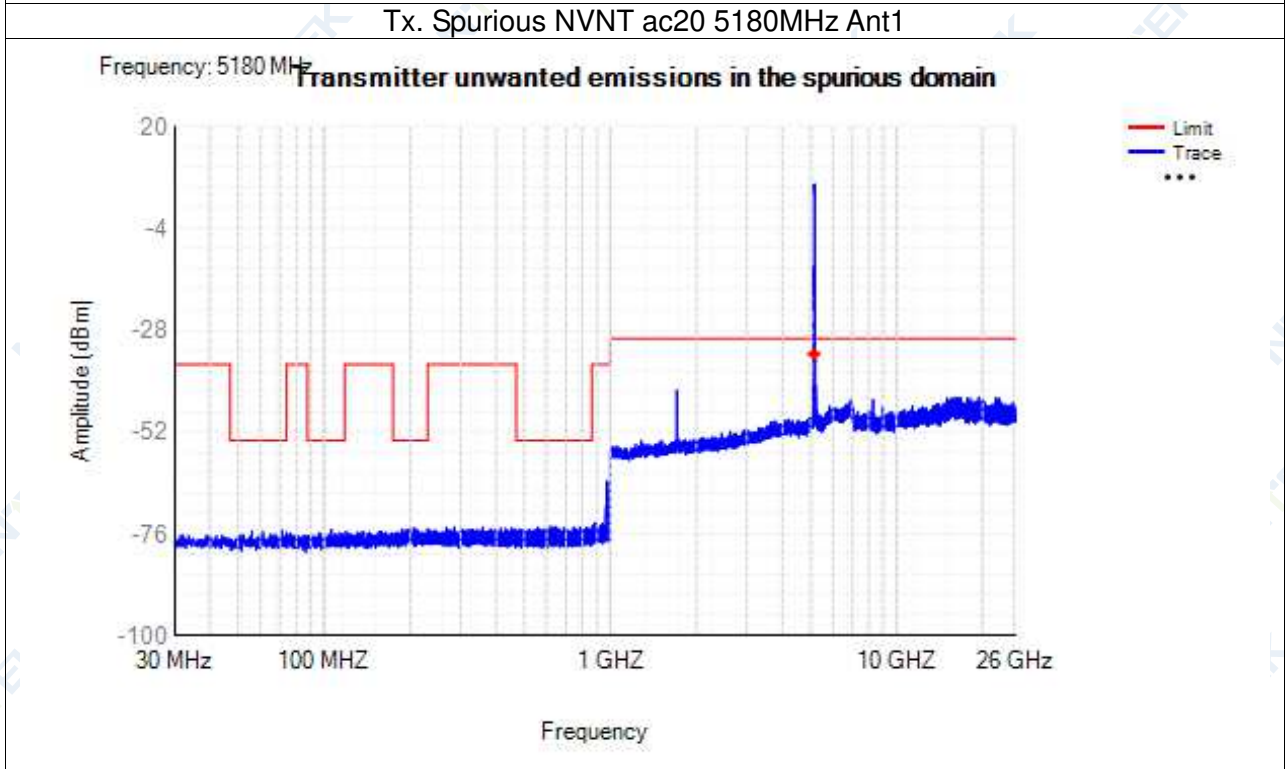

Tx. Spurious NVNT ac40 5190MHz Ant1

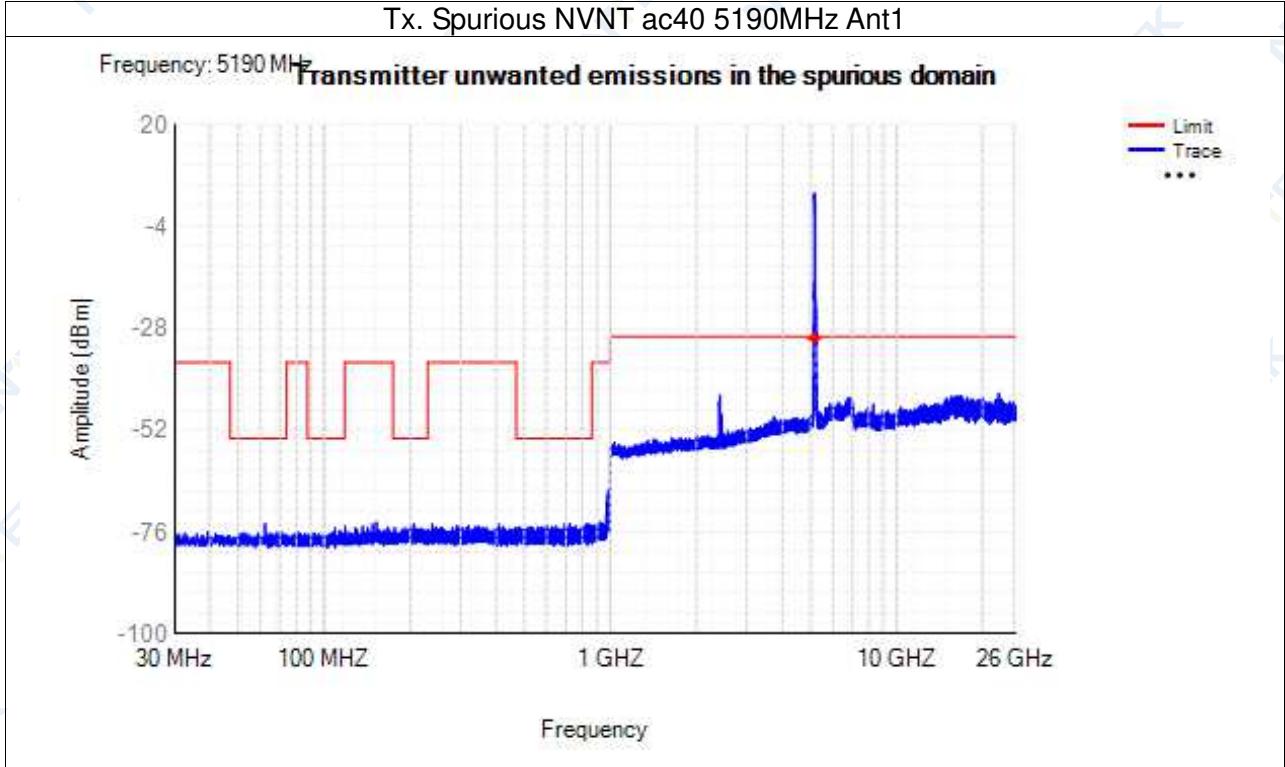

Tx. Spurious NVNT ac80 5210MHz Ant1

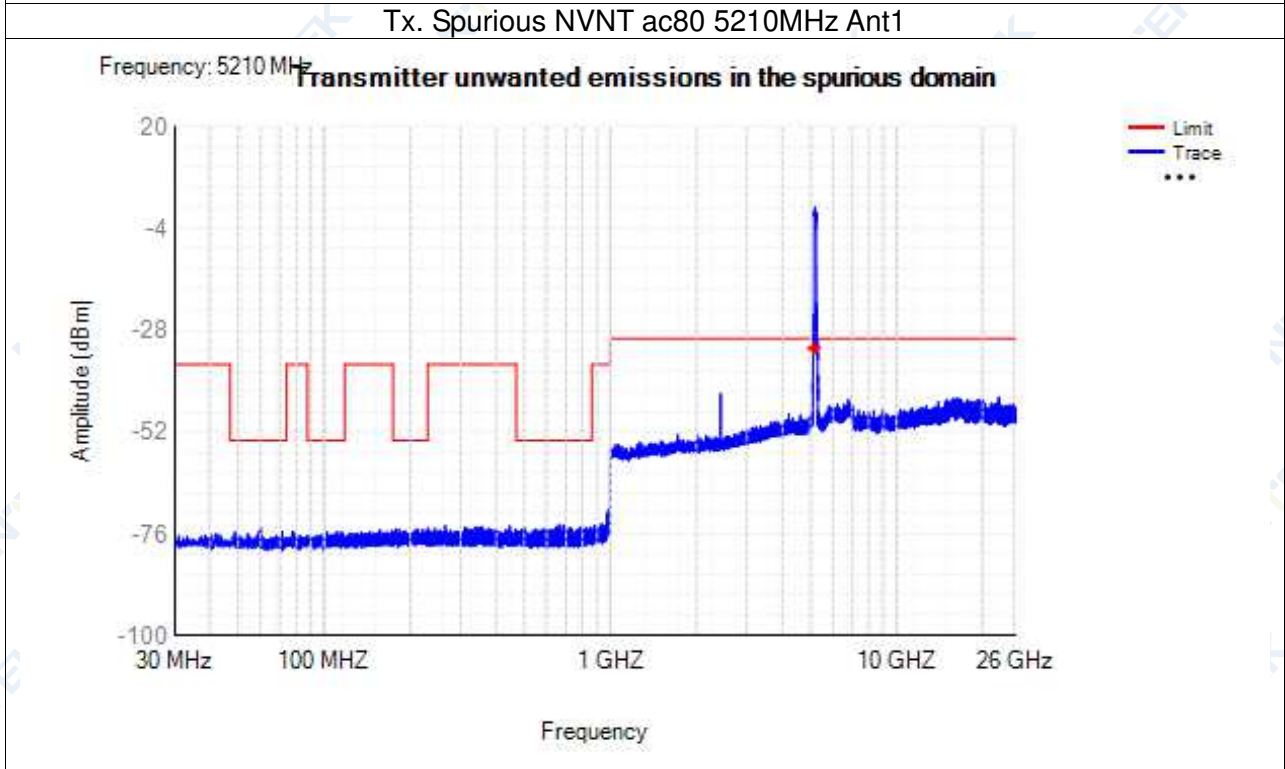

13.5 Transmitter unwanted emissions within the 5 GHz RLAN bands

Condition	Mode	Frequency (MHz)	Antenna	Sub Band	Worst EIB Frequency (MHz)	Level (dB)	Limit (dB)	Verdict
NVNT	a	5180	Ant1	Band1	5151	-47.08	-38.79	Pass
NVNT	a	5180	Ant1	Band2	5652.73	-66.45	-47	Pass
NVNT	n20	5180	Ant1	Band1	5150.4	-46.54	-39.52	Pass
NVNT	n20	5180	Ant1	Band2	5720.41	-66.69	-47	Pass
NVNT	n40	5190	Ant1	Band1	5154.88	-34.02	-25.83	Pass
NVNT	n40	5190	Ant1	Band2	5652.58	-62.61	-47	Pass
NVNT	ac20	5180	Ant1	Band1	5150.32	-46.1	-39.61	Pass
NVNT	ac20	5180	Ant1	Band2	5724.24	-66.46	-47	Pass
NVNT	ac40	5190	Ant1	Band1	5152.56	-34.9	-26.86	Pass
NVNT	ac40	5190	Ant1	Band2	5652.68	-62.62	-47	Pass
NVNT	ac80	5210	Ant1	Band1	5297.64	-34.68	-30.29	Pass
NVNT	ac80	5210	Ant1	Band2	5715.87	-58.49	-40	Pass

Test Graphs

Tx. Emissions EIB NVNT a 5180MHz Sub Band1

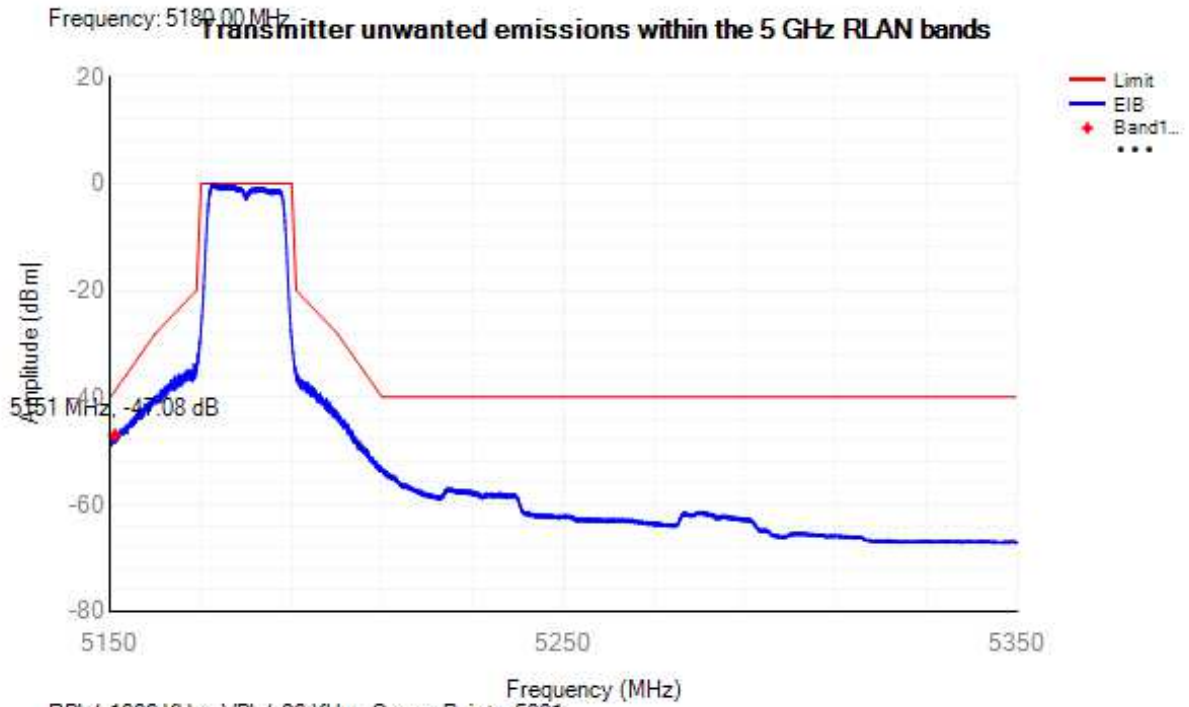

Tx. Emissions EIB NVNT a 5180MHz Sub Band2

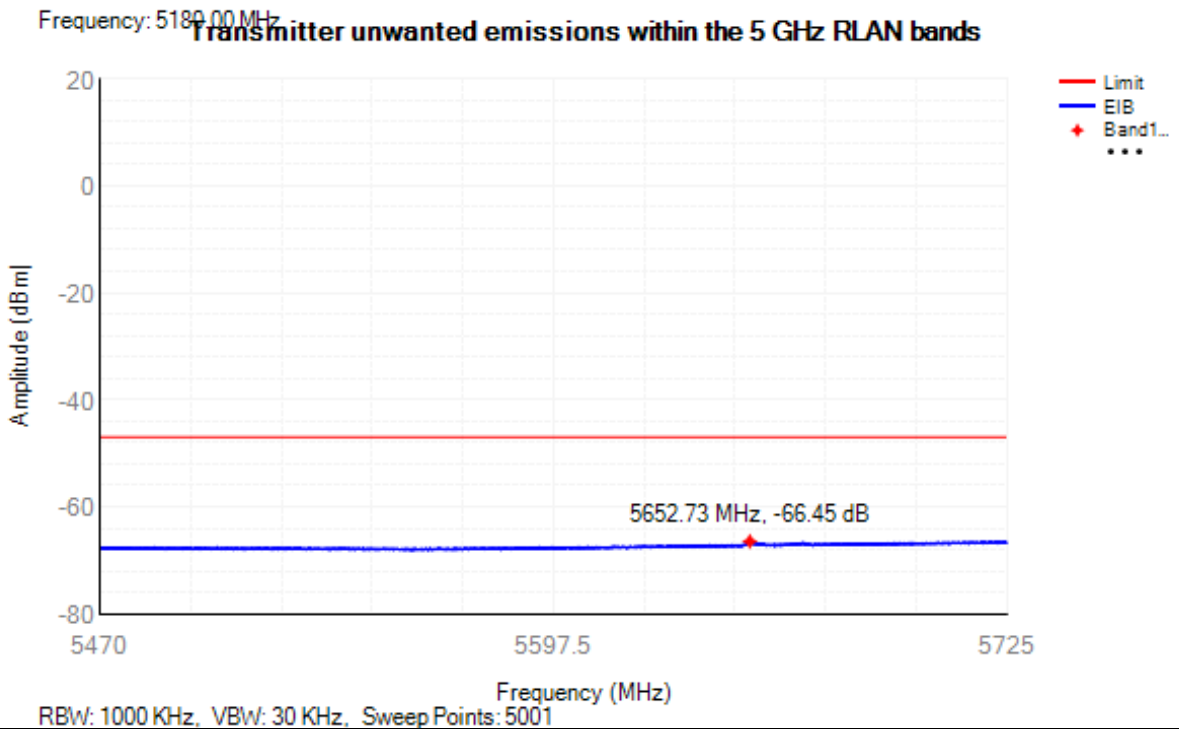

Tx. Emissions EIB NVNT n20 5180MHz Sub Band1

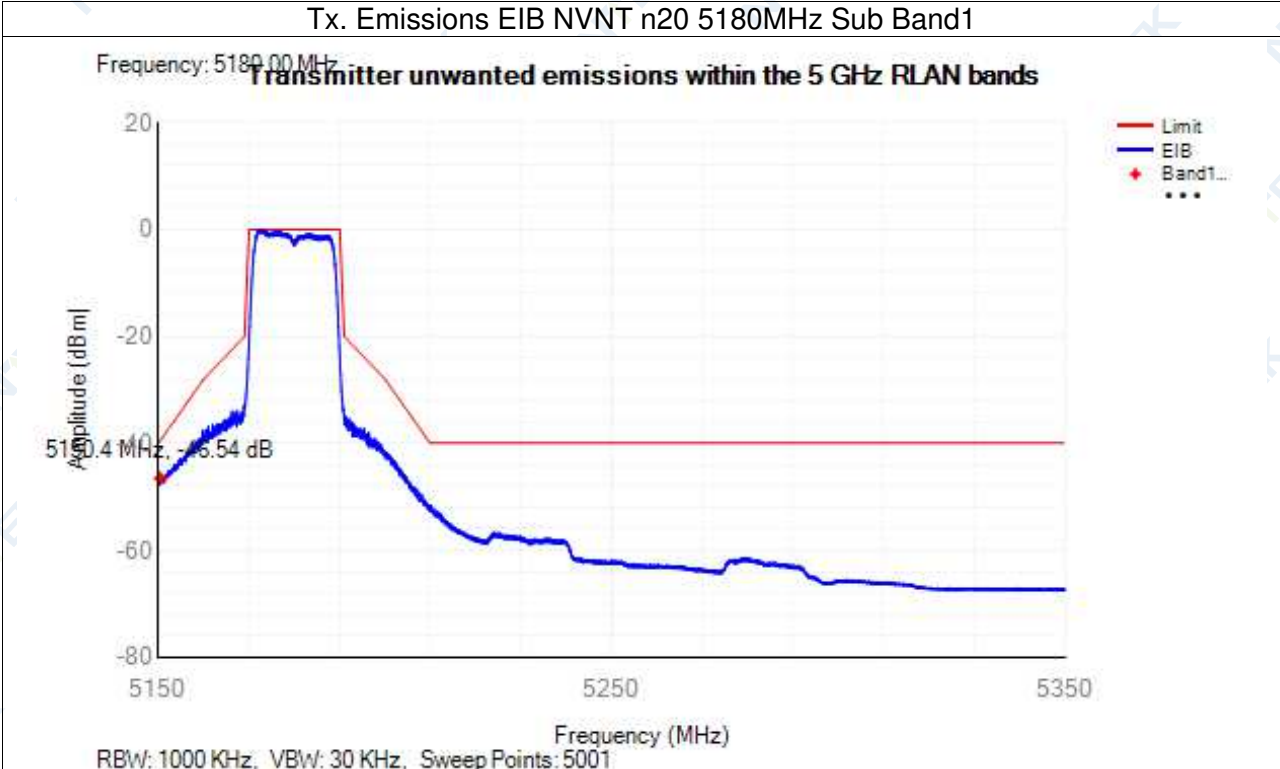

Tx. Emissions EIB NVNT n20 5180MHz Sub Band2

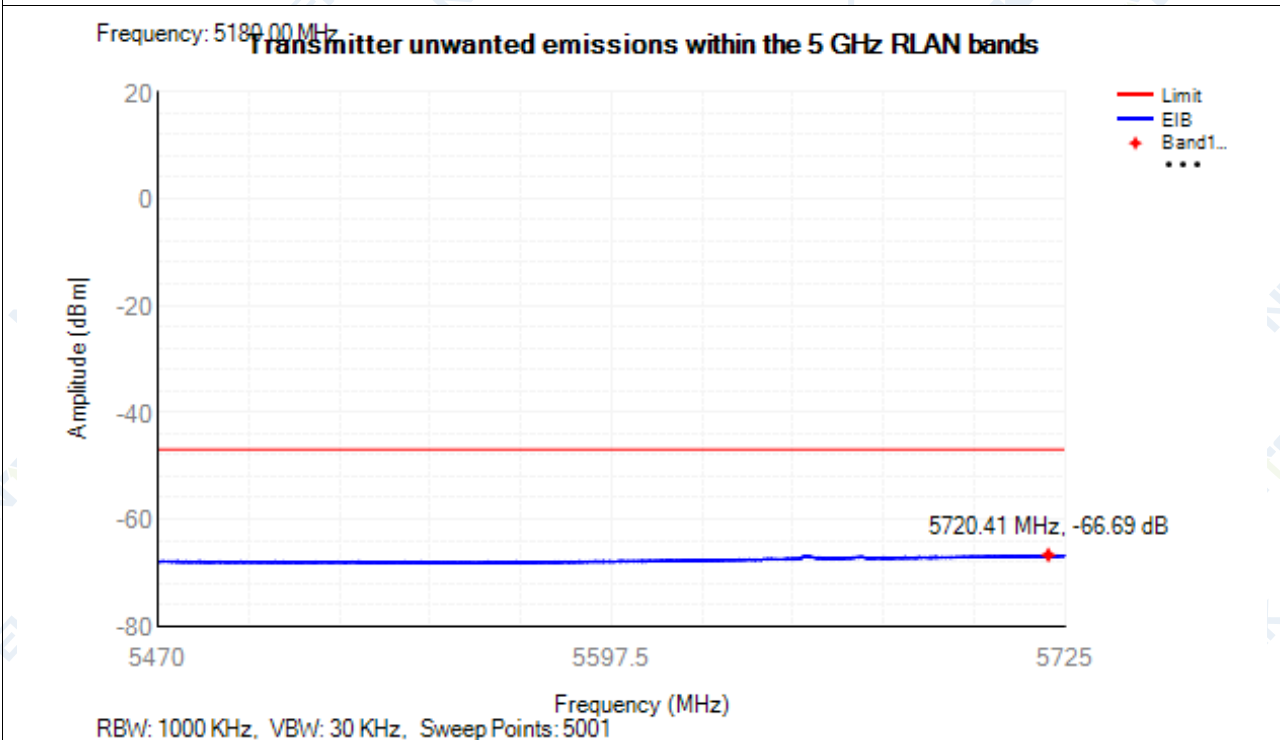

Tx. Emissions EIB NVNT n40 5190MHz Sub Band1



Tx. Emissions EIB NVNT n40 5190MHz Sub Band2

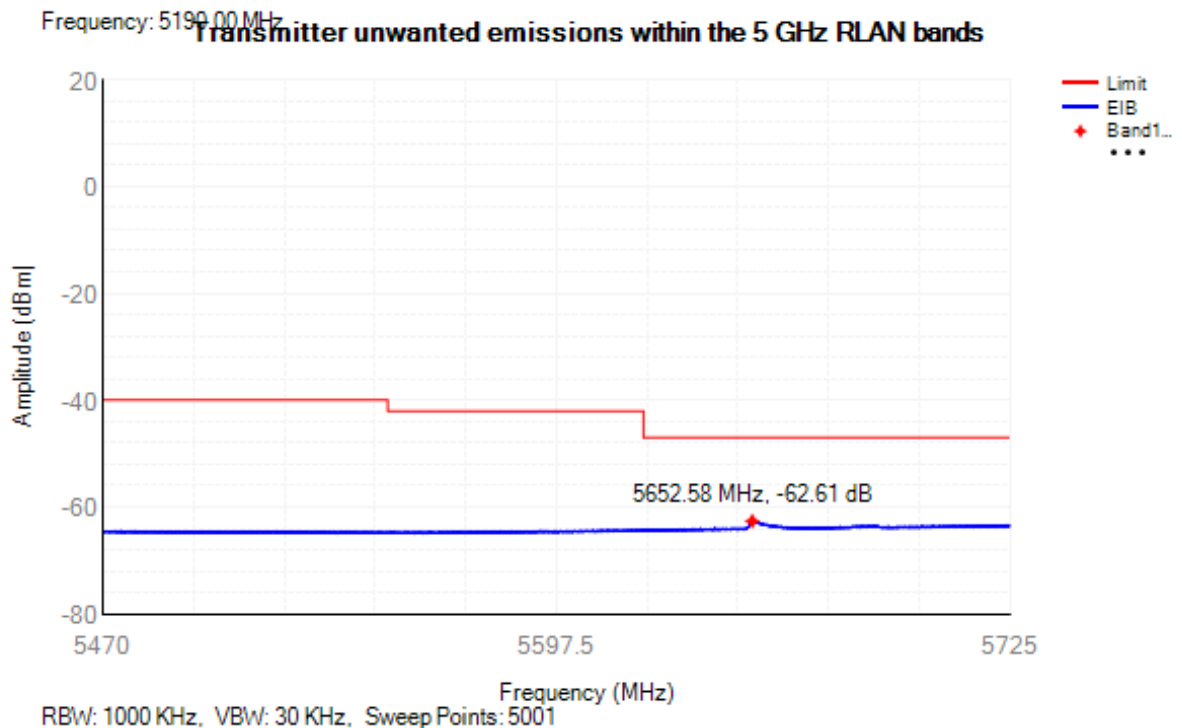

Tx. Emissions EIB NVNT ac20 5180MHz Sub Band1

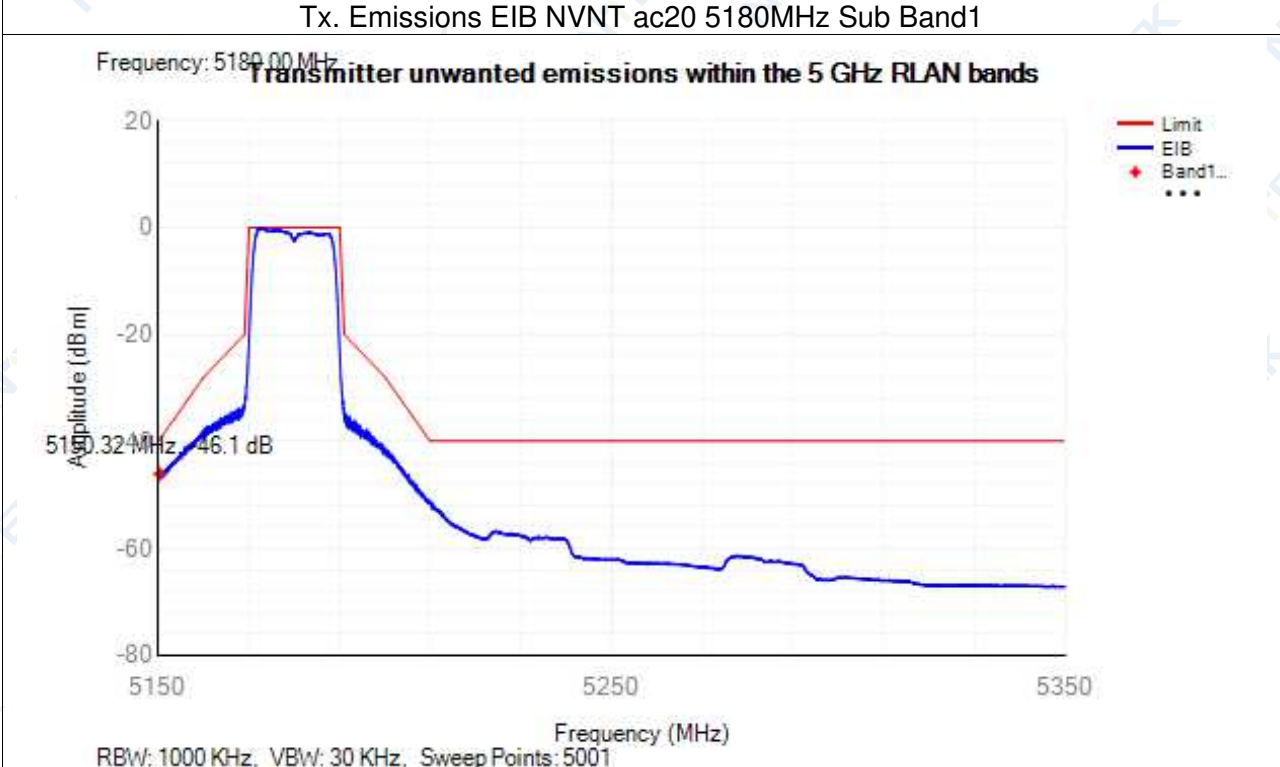

Tx. Emissions EIB NVNT ac20 5180MHz Sub Band2

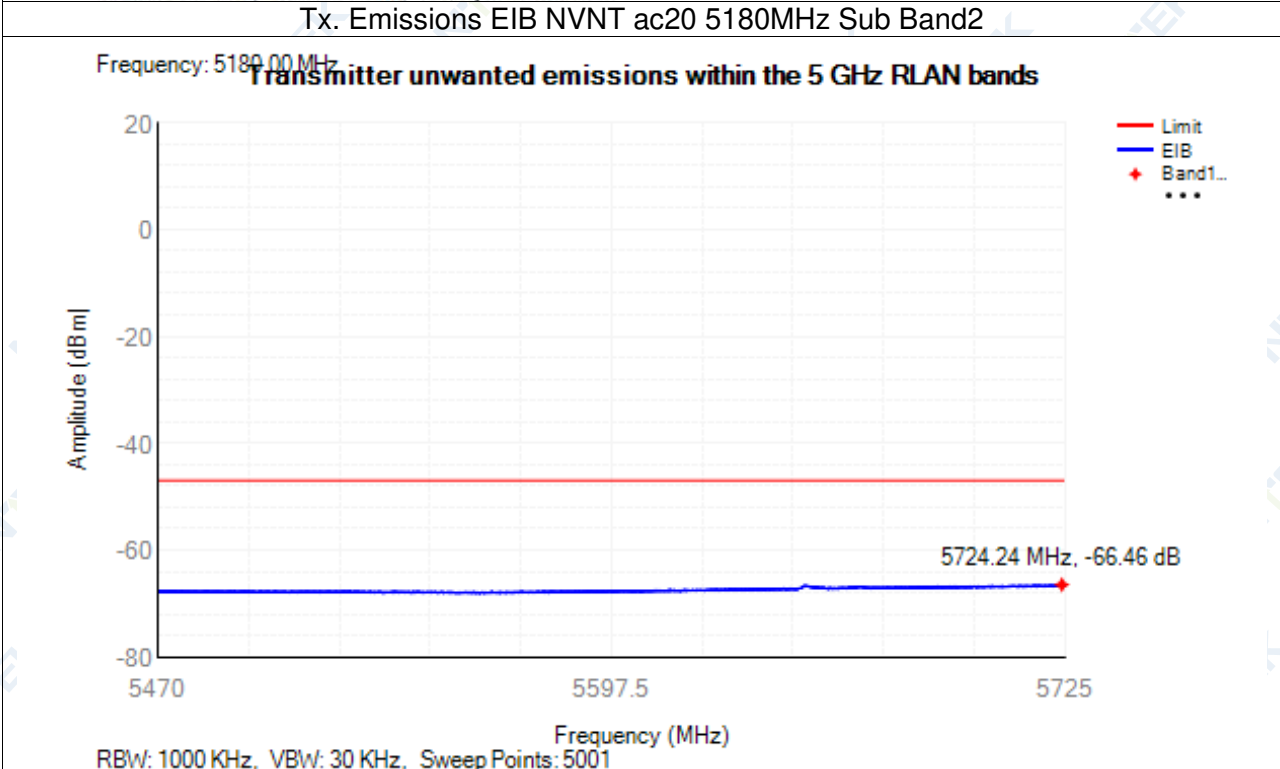

Tx. Emissions EIB NVNT ac40 5190MHz Sub Band1

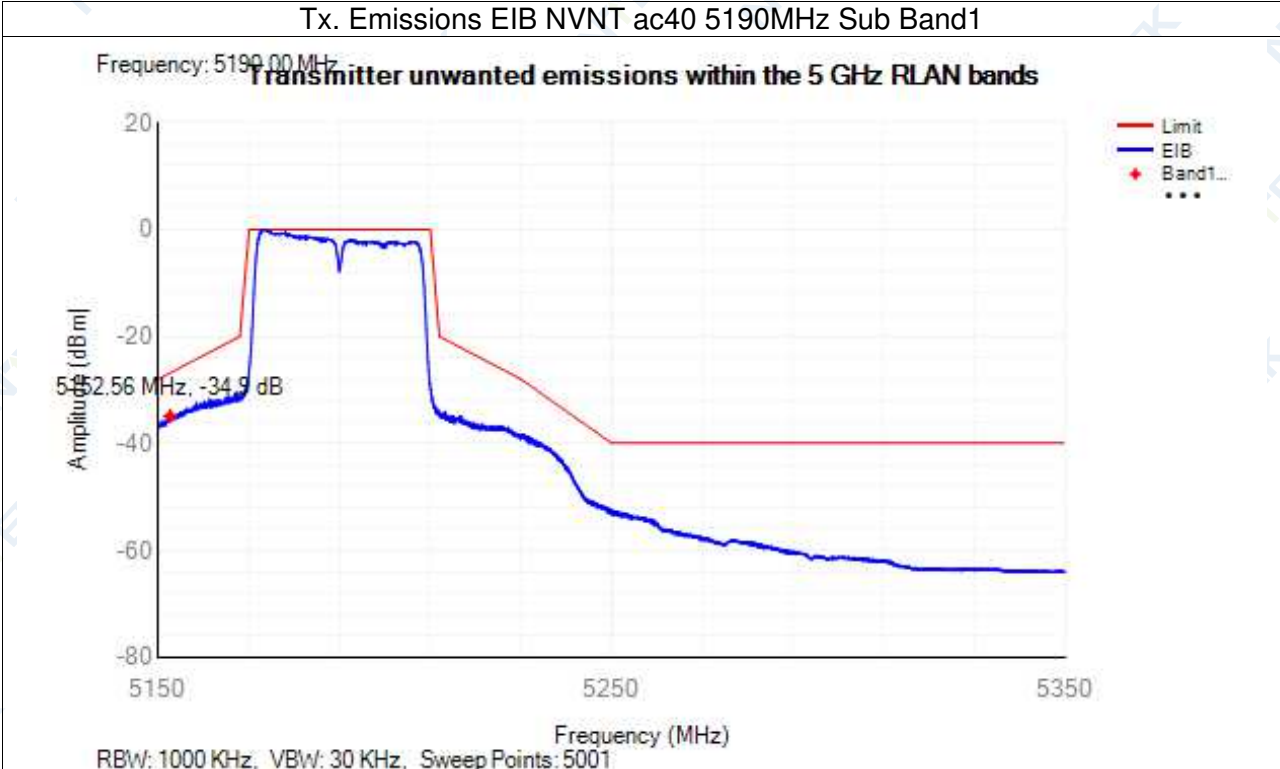

Tx. Emissions EIB NVNT ac40 5190MHz Sub Band2

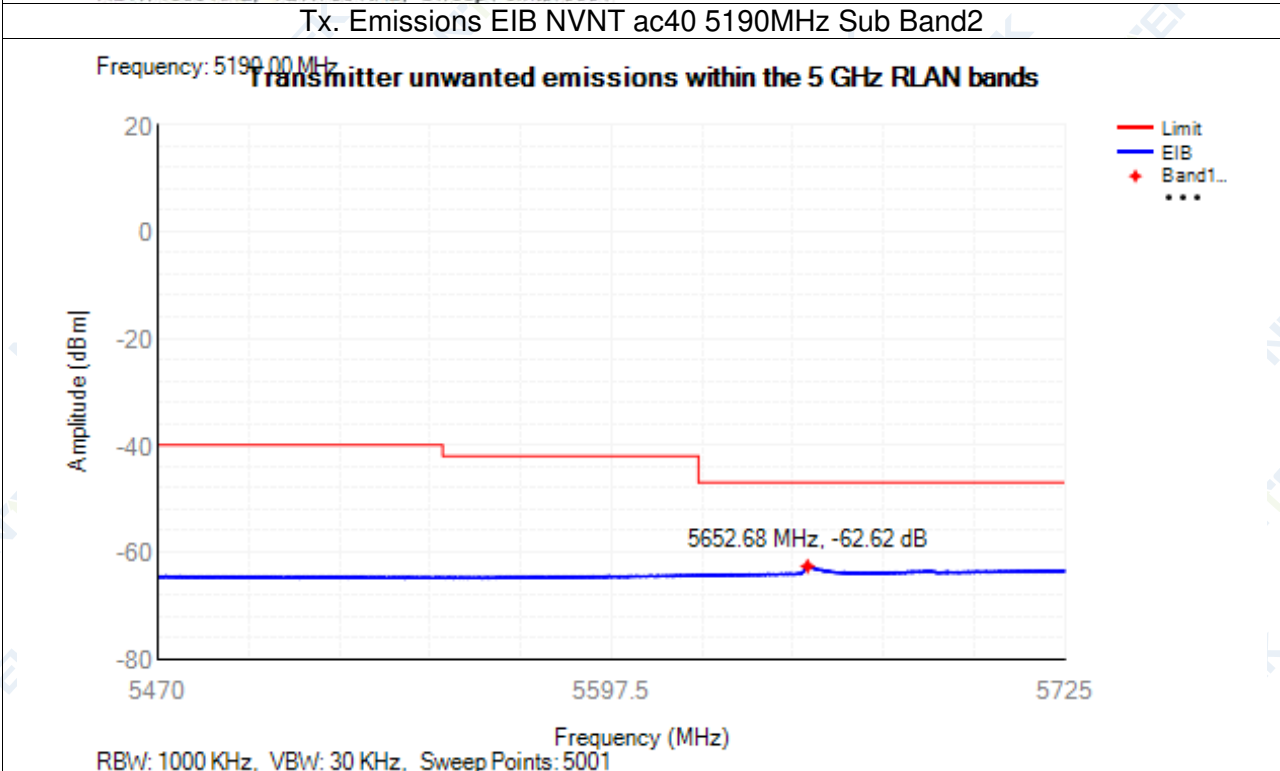

Tx. Emissions EIB NVNT ac80 5210MHz Sub Band1

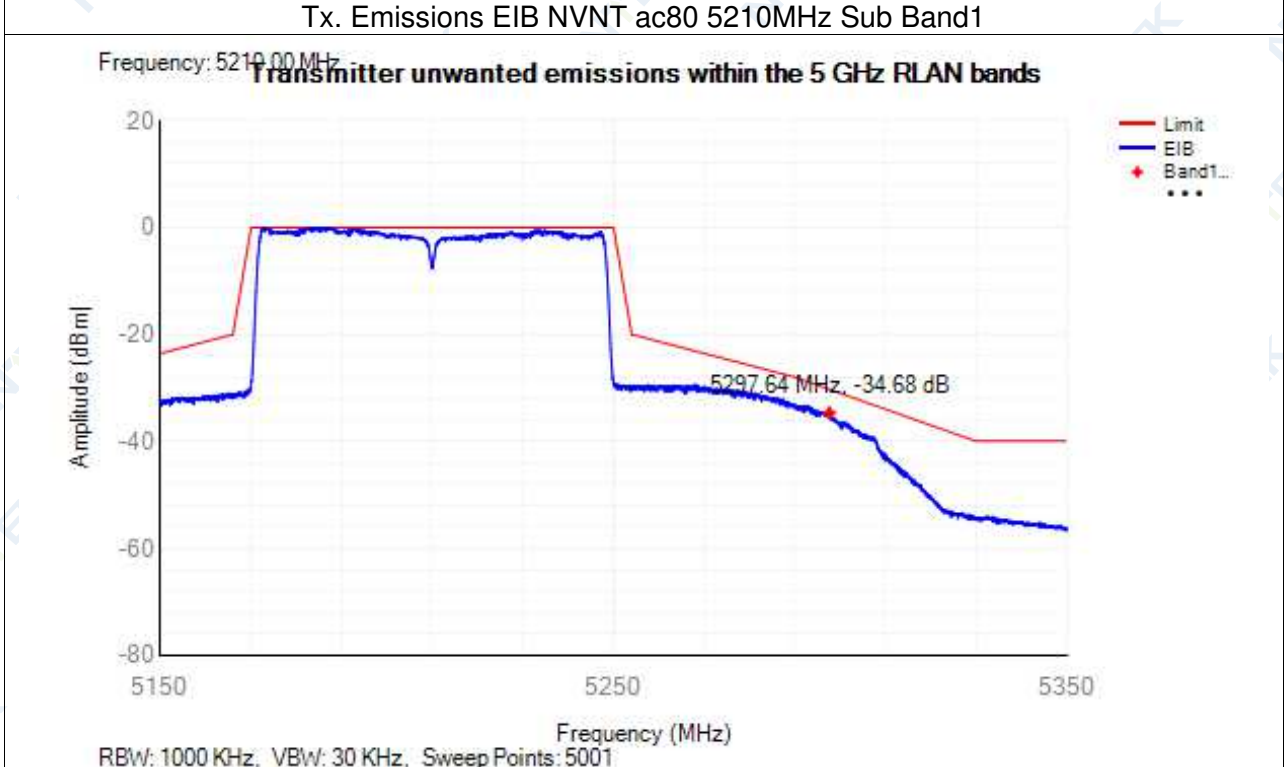

Tx. Emissions EIB NVNT ac80 5210MHz Sub Band2

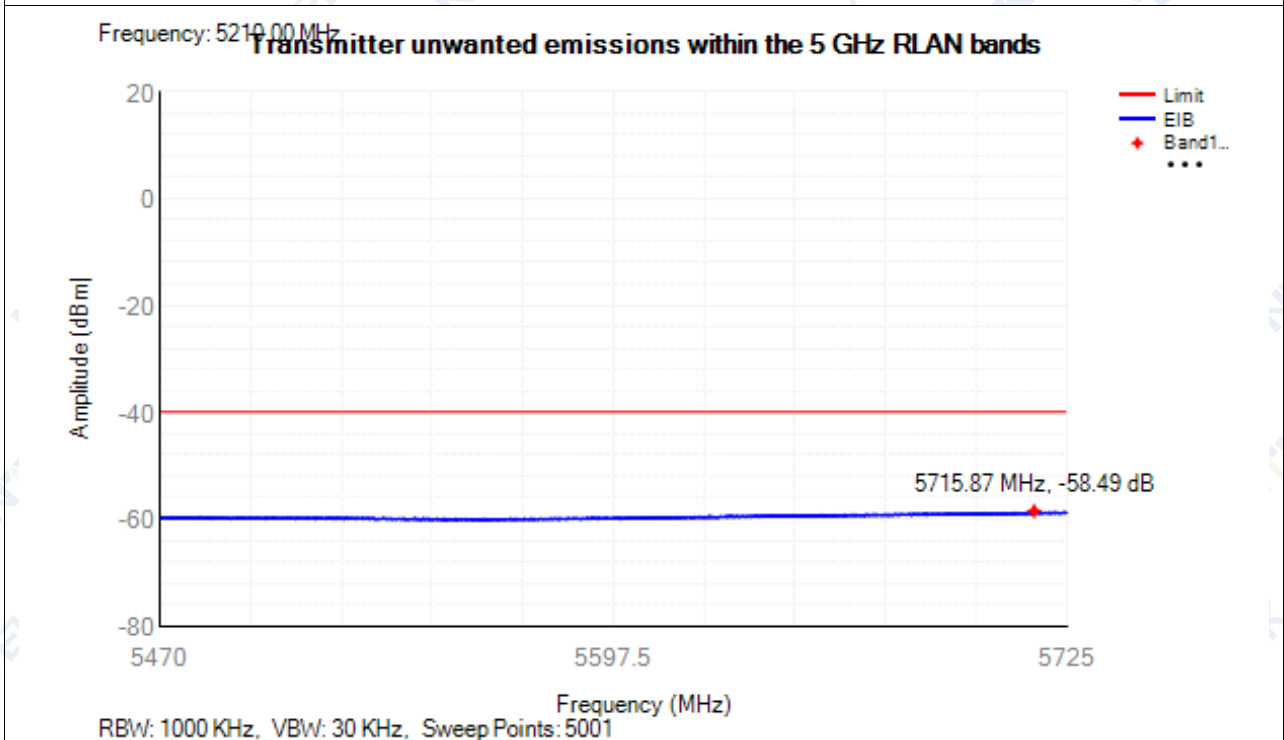

13.6 Receiver spurious emissions

Condition	Mode	Frequency (MHz)	Antenna	Range (MHz)	Spur Freq (MHz)	Peak (dBm)	RMS (dBm)	Limit (dBm)	Verdict
NVNT	a	5180	Ant1	30 -1000	944.3	-81.94	NA	-57	Pass
NVNT	a	5180	Ant1	1000 -26000	2429	-53.42	NA	-47	Pass
NVNT	n20	5180	Ant1	30 -1000	879.6	-80.72	NA	-57	Pass
NVNT	n20	5180	Ant1	1000 -26000	2442	-54.44	NA	-47	Pass
NVNT	n40	5190	Ant1	30 -1000	944.3	-80.99	NA	-57	Pass
NVNT	n40	5190	Ant1	1000 -26000	2462	-54.05	NA	-47	Pass
NVNT	ac20	5180	Ant1	30 -1000	948.9	-80.58	NA	-57	Pass
NVNT	ac20	5180	Ant1	1000 -26000	8336	-64.08	NA	-47	Pass
NVNT	ac40	5190	Ant1	30 -1000	869.8	-81.86	NA	-57	Pass
NVNT	ac40	5190	Ant1	1000 -26000	2426	-55.87	NA	-47	Pass
NVNT	ac80	5210	Ant1	30 -1000	650.1	-82.79	NA	-57	Pass
NVNT	ac80	5210	Ant1	1000 -26000	2480	-59.18	NA	-47	Pass

Test Graphs

Rx. Spurious NVNT a 5180MHz Ant1

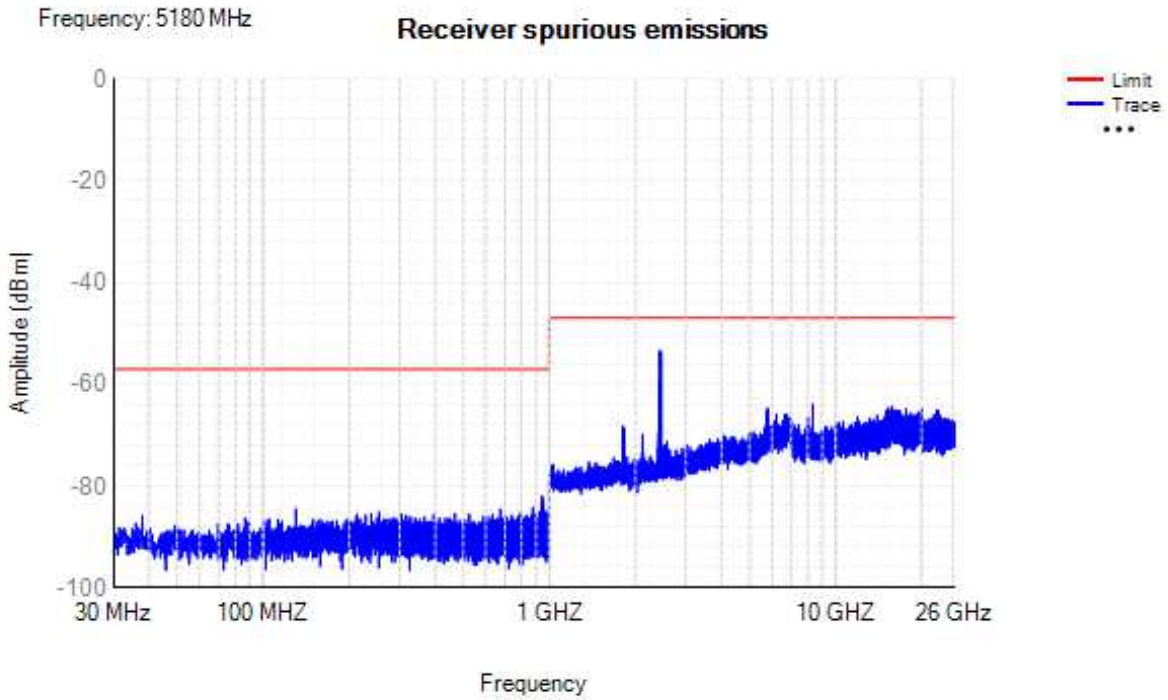

Rx. Spurious NVNT n20 5180MHz Ant1

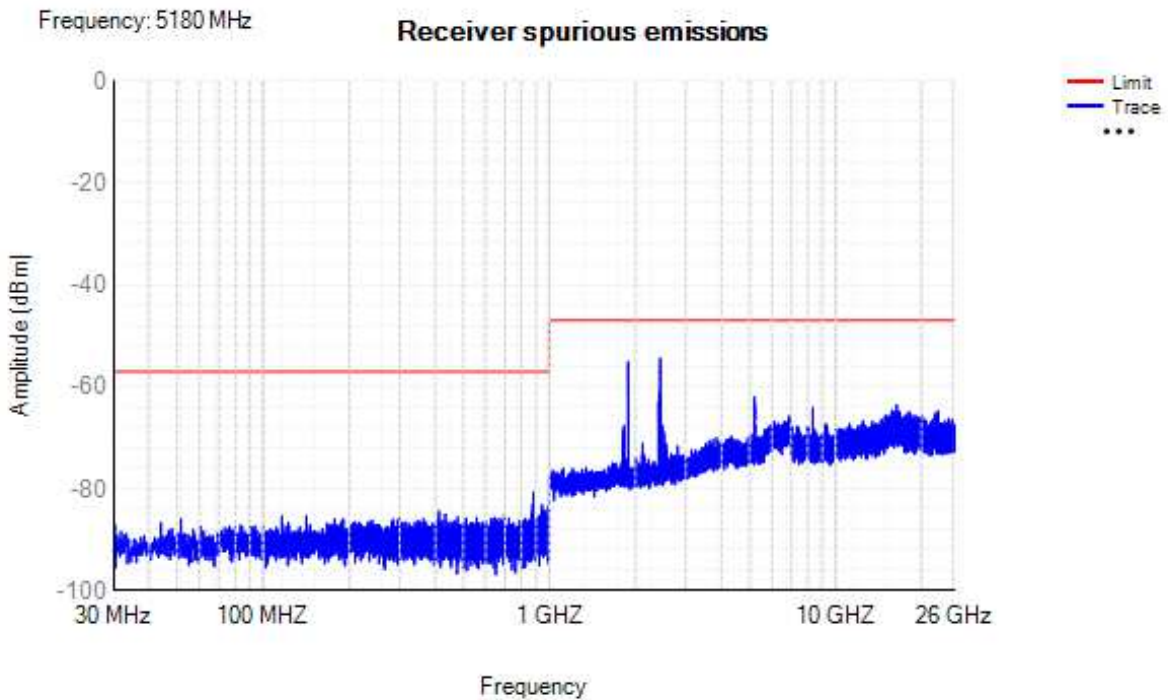

Rx. Spurious NVNT n40 5190MHz Ant1

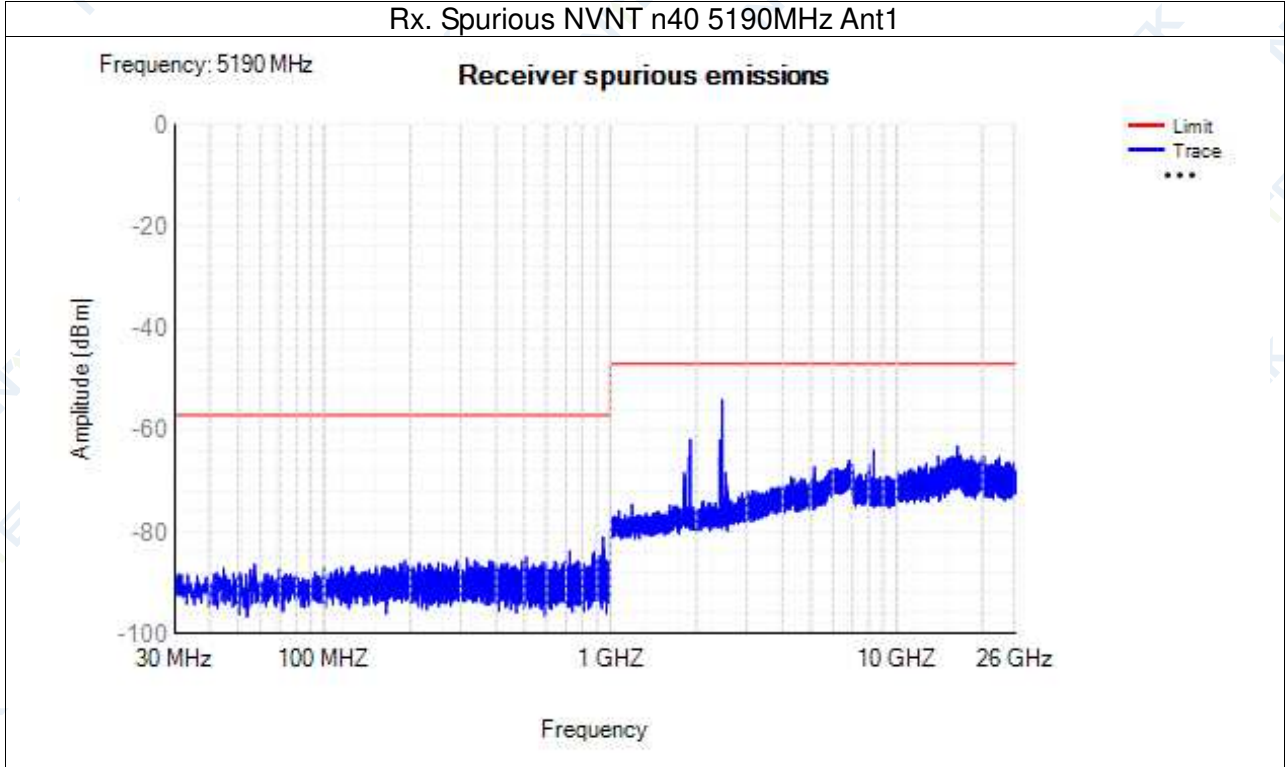

Rx. Spurious NVNT ac20 5180MHz Ant1

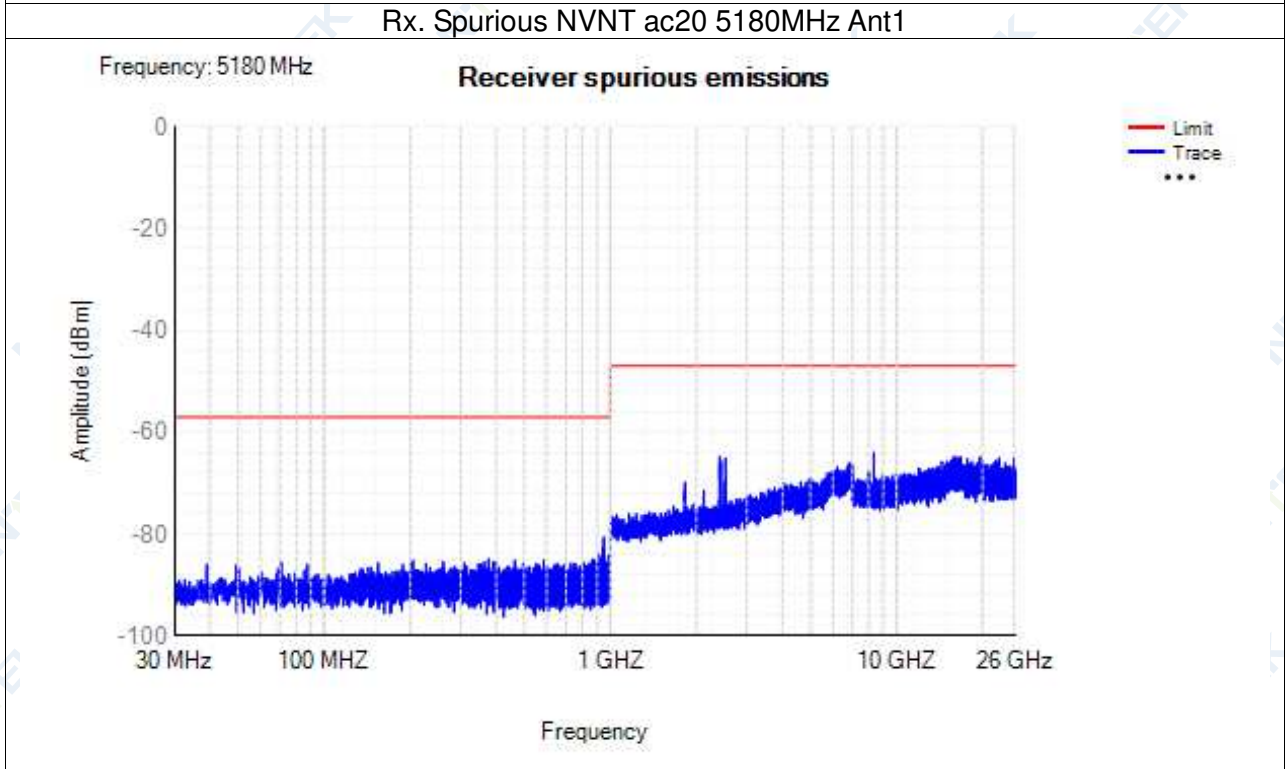

Rx. Spurious NVNT ac40 5190MHz Ant1

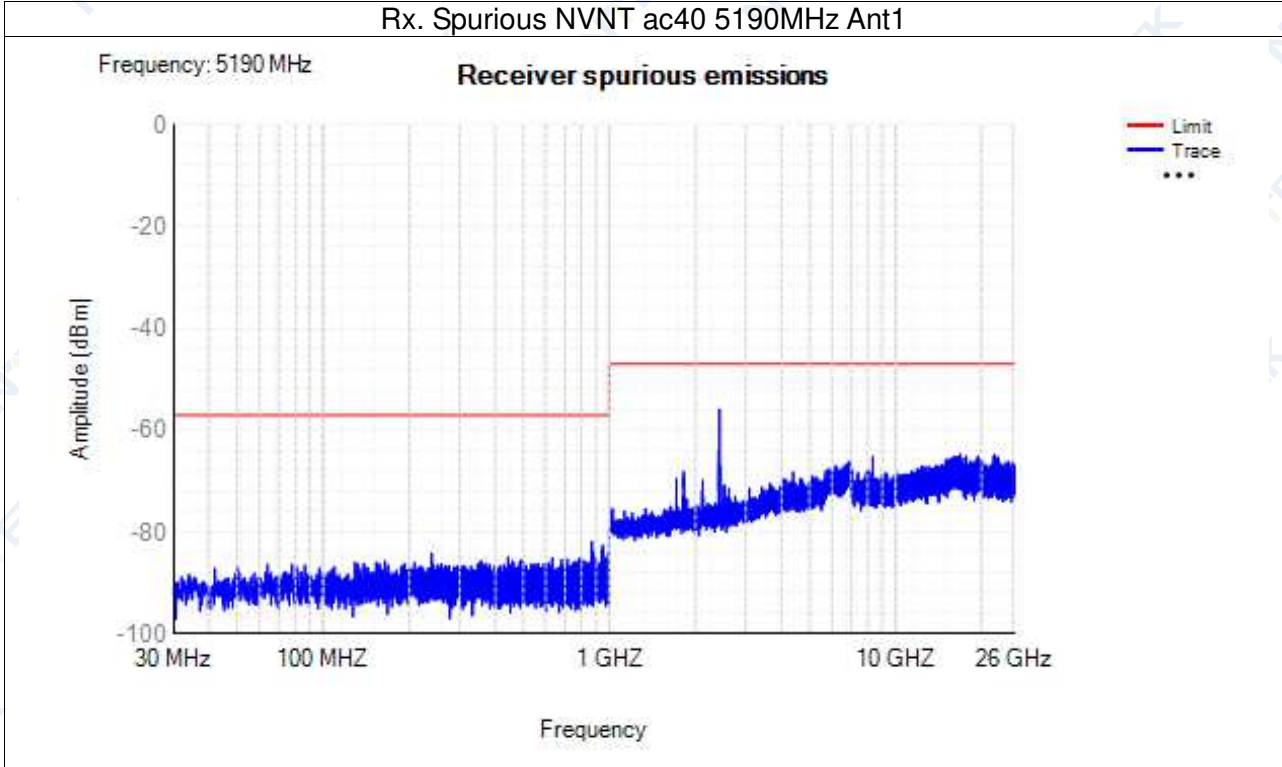

Rx. Spurious NVNT ac80 5210MHz Ant1

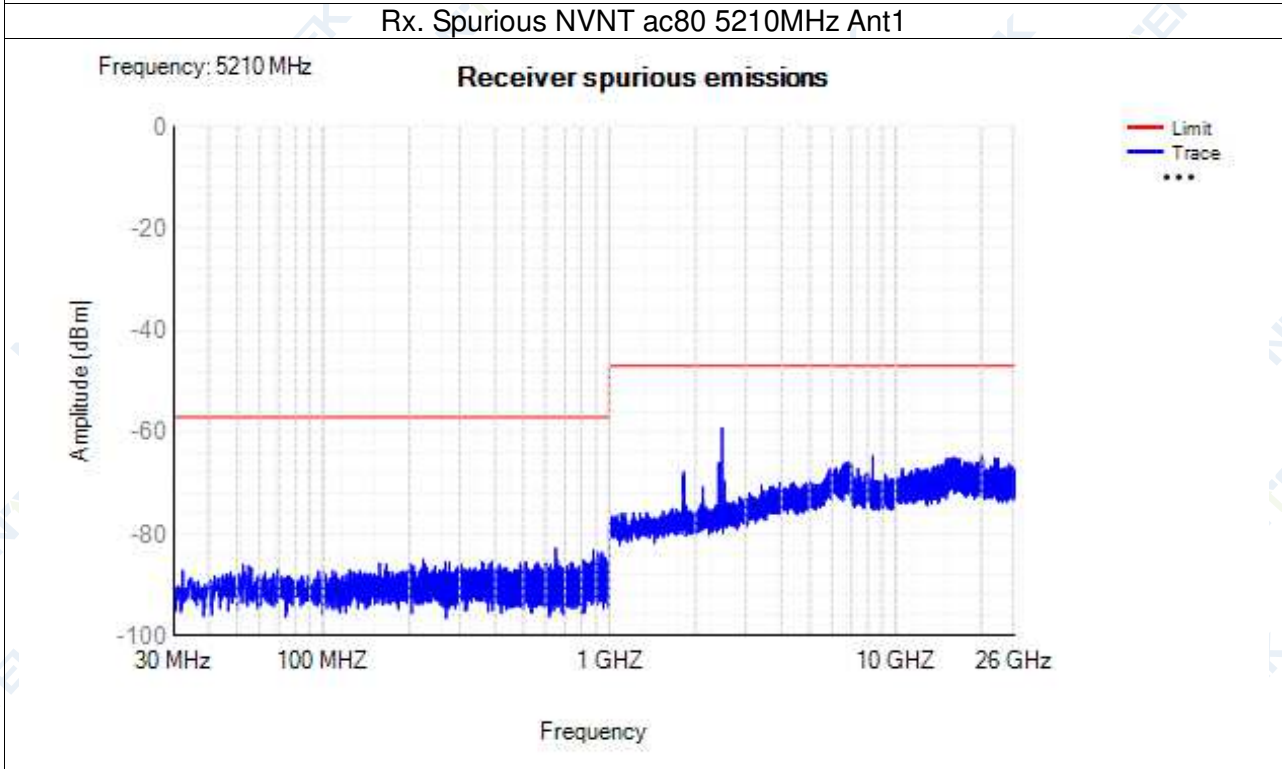

13.7 Adaptivity

Condition	Mode	Frequency (MHz)	Interfer Type	Interfer Level (dBm/MHz)	Short Control (ms)	Limit (ms)	Short Control (n)	Limit (n)	Verdict
NVNT	802.11a	5180	AWGN	-75	0	<=2.5	0	<=50	Pass
NVNT	802.11a	5180	LTE	-75	0	<=2.5	0	<=50	Pass
NVNT	802.11a	5180	OFDM	-75	0	<=2.5	0	<=50	Pass
NVNT	802.11ac80	5210	AWGN	-75	1.4	<=2.5	3	<=50	Pass
NVNT	802.11ac80	5210	LTE	-75	0	<=2.5	0	<=50	Pass
NVNT	802.11ac80	5210	OFDM	-75	0	<=2.5	0	<=50	Pass
NVNT	802.11n(HT40)	5190	AWGN	-75	0	<=2.5	0	<=50	Pass
NVNT	802.11n(HT40)	5190	LTE	-75	0	<=2.5	0	<=50	Pass
NVNT	802.11n(HT40)	5190	OFDM	-75	0	<=2.5	0	<=50	Pass

Adaptivity NVNT 802.11a 5180MHz AWGN

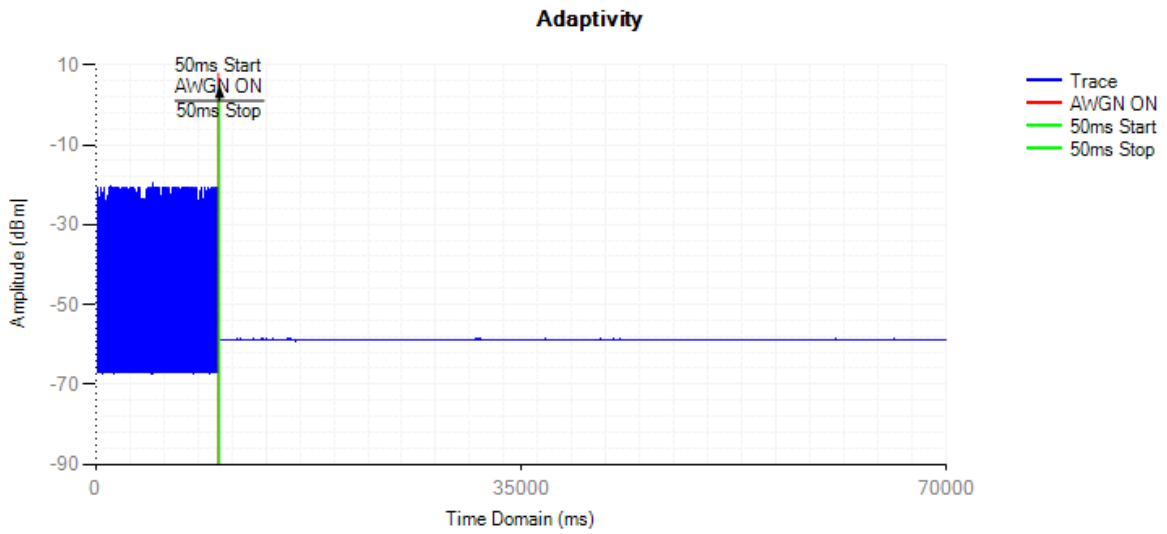

Control Signal NVNT 802.11a 5180MHz AWGN

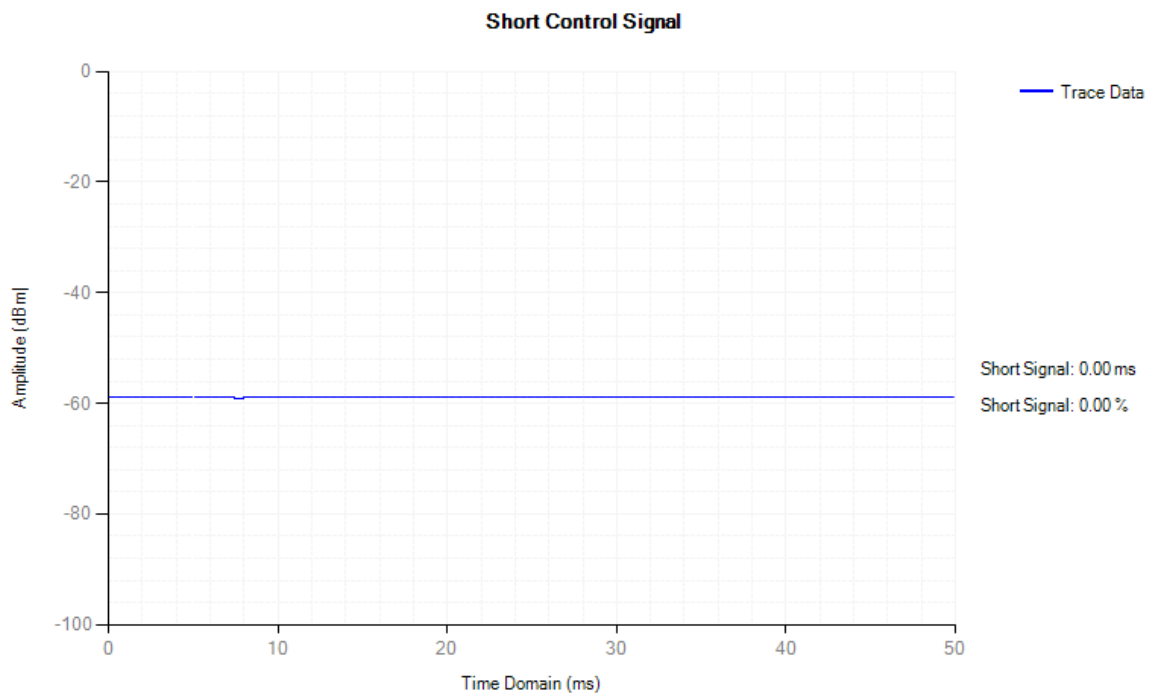

Adaptivity NVNT 802.11a 5180MHz LTE

Adaptivity

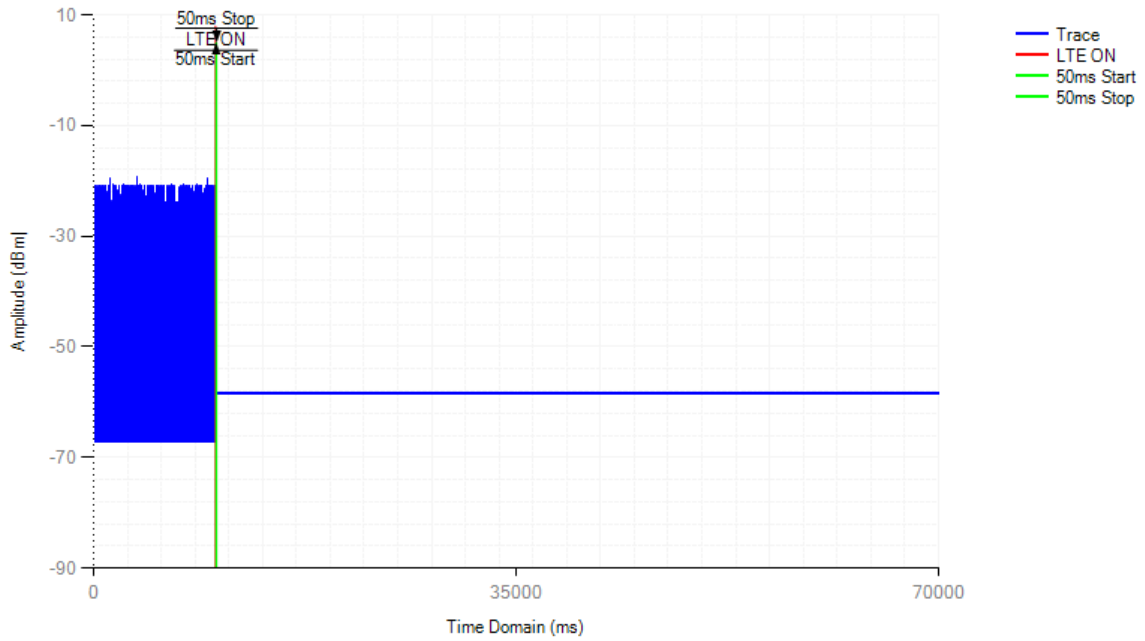

Control Signal NVNT 802.11a 5180MHz LTE

Short Control Signal

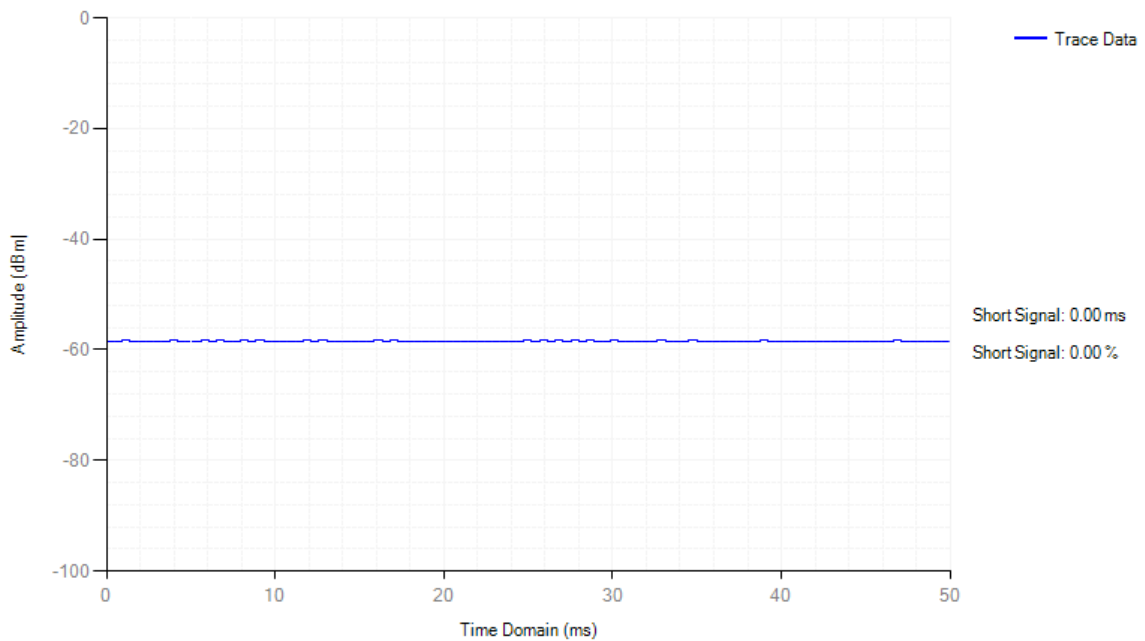

Adaptivity NVNT 802.11a 5180MHz OFDM

Adaptivity

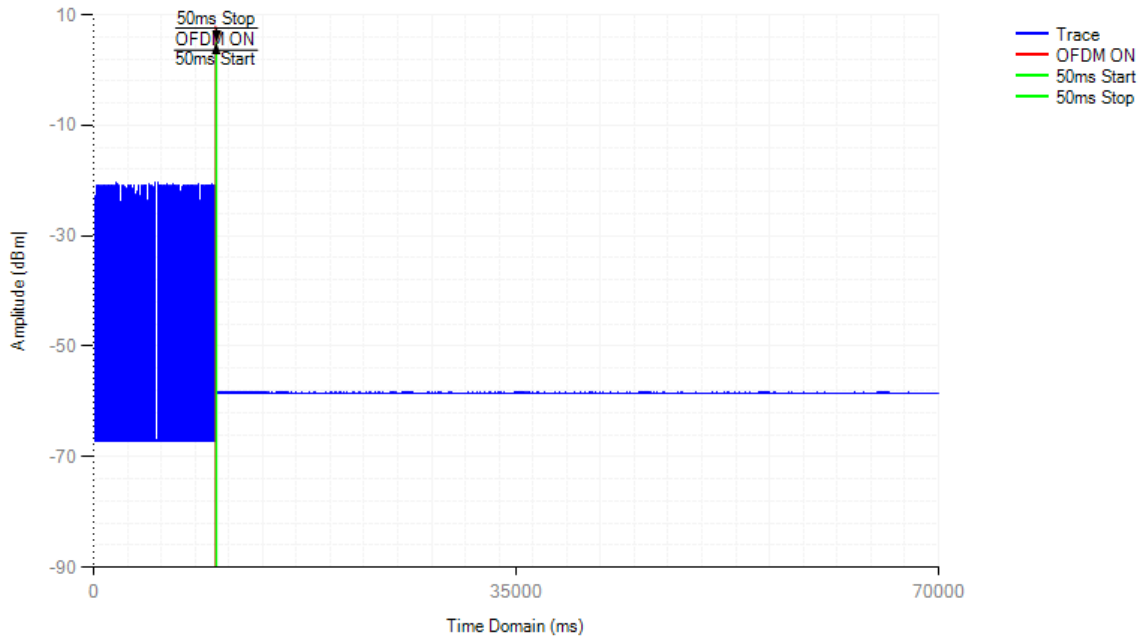

Control Signal NVNT 802.11a 5180MHz OFDM

Short Control Signal

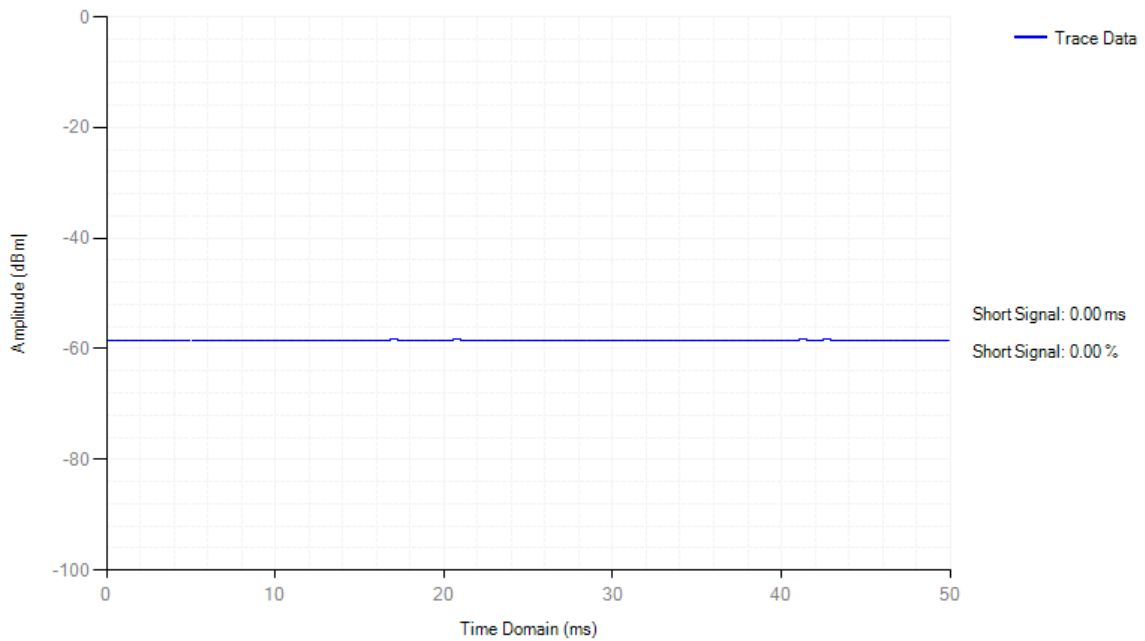

Adaptivity NVNT 802.11ac80 5210MHz AWGN

Adaptivity

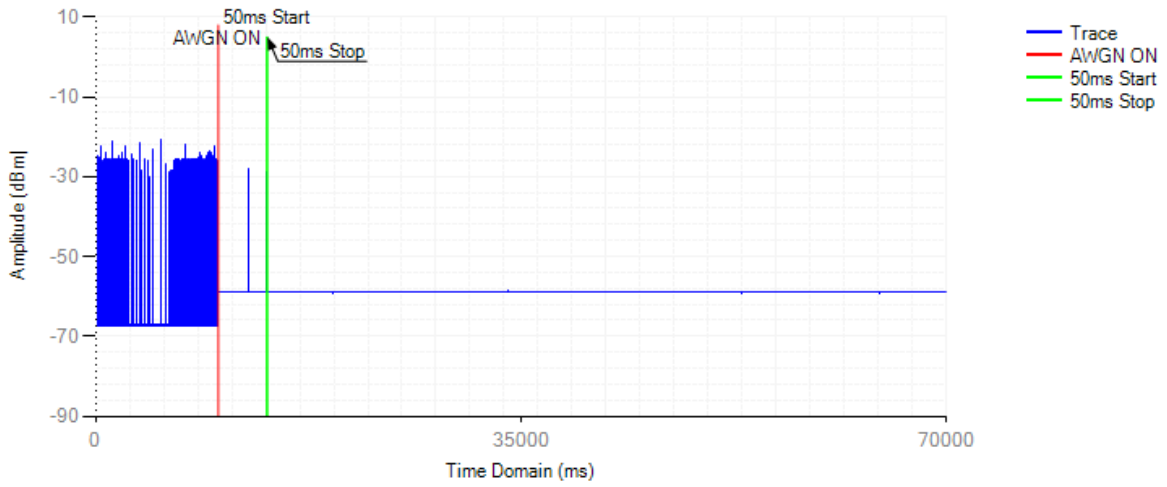

Control Signal NVNT 802.11ac80 5210MHz AWGN

Short Control Signal

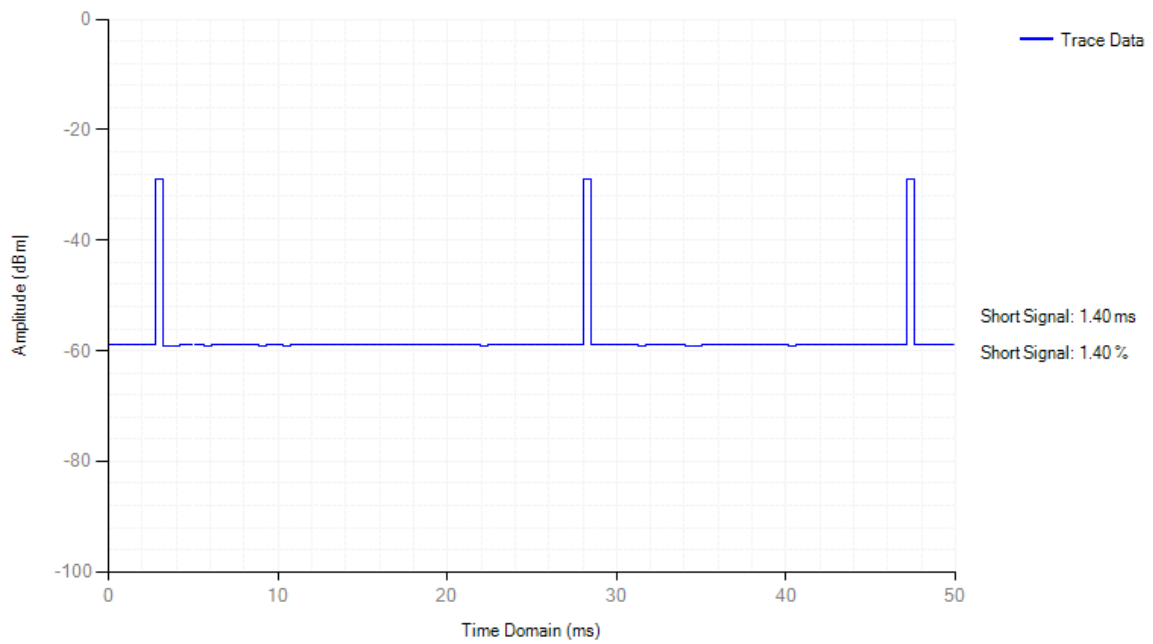

Adaptivity NVNT 802.11ac80 5210MHz LTE

Adaptivity

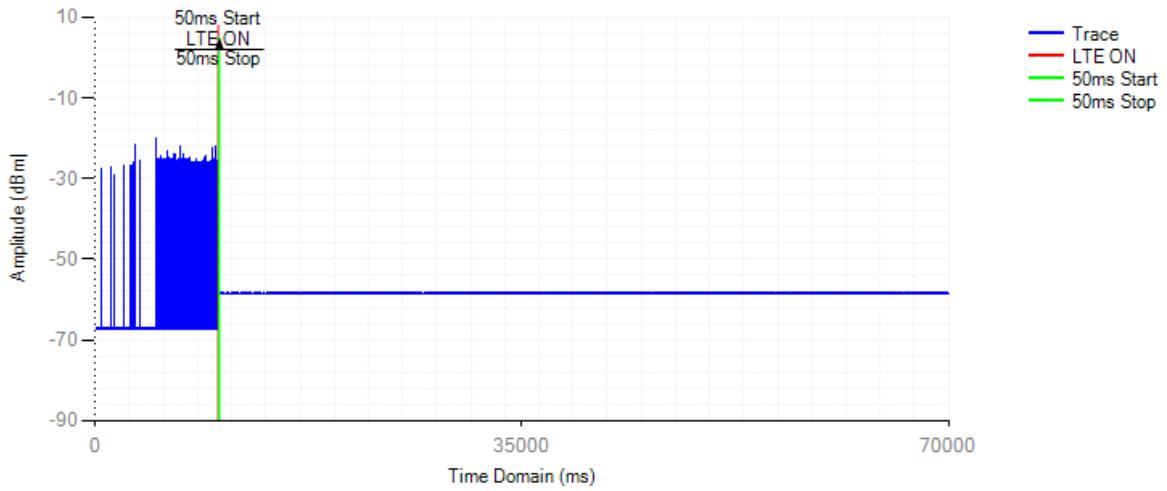

Control Signal NVNT 802.11ac80 5210MHz LTE

Short Control Signal

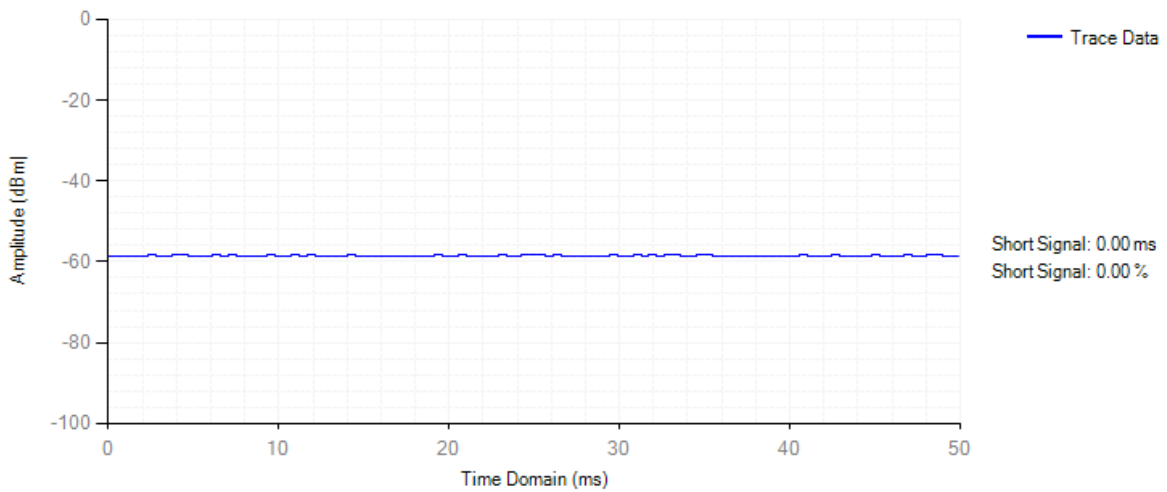

Adaptivity NVNT 802.11ac80 5210MHz OFDM

Adaptivity

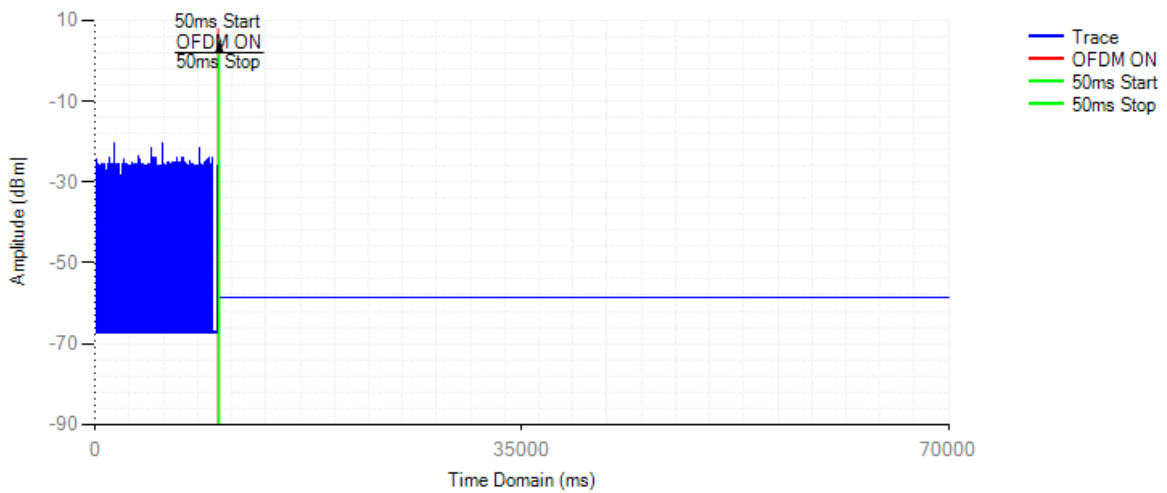

Control Signal NVNT 802.11ac80 5210MHz OFDM

Short Control Signal

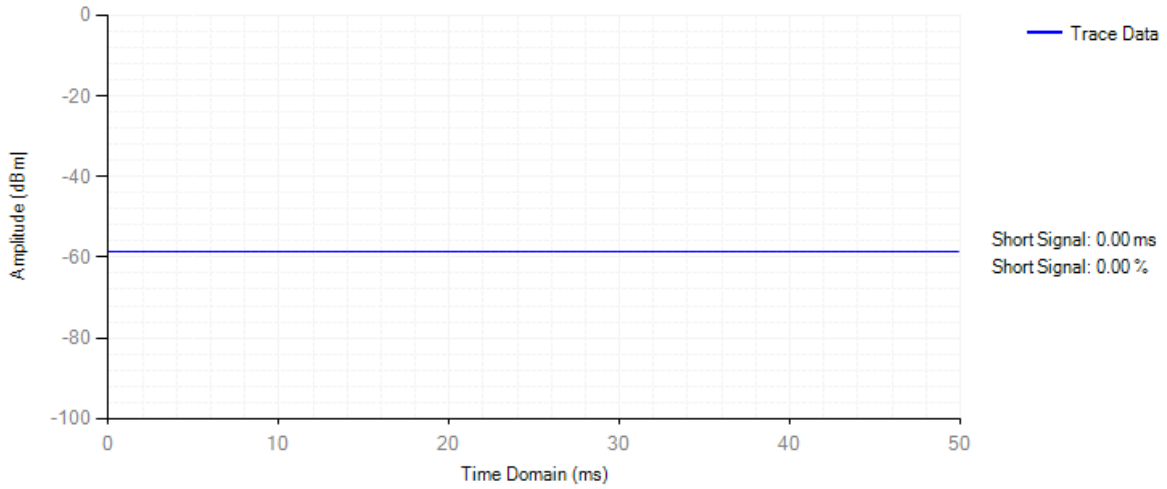

Adaptivity NVNT 802.11n(HT40) 5190MHz AWGN

Adaptivity

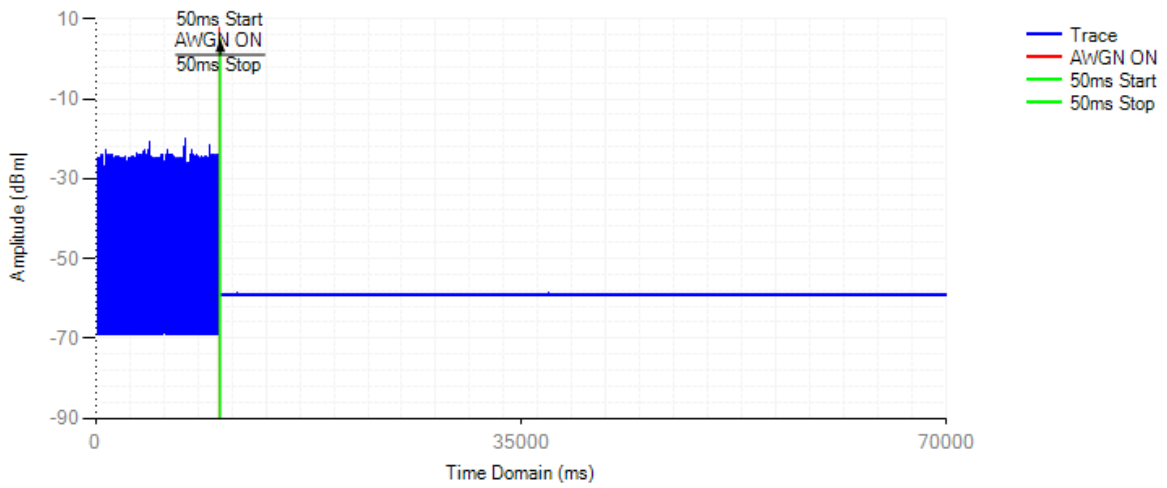

Control Signal NVNT 802.11n(HT40) 5190MHz AWGN

Short Control Signal

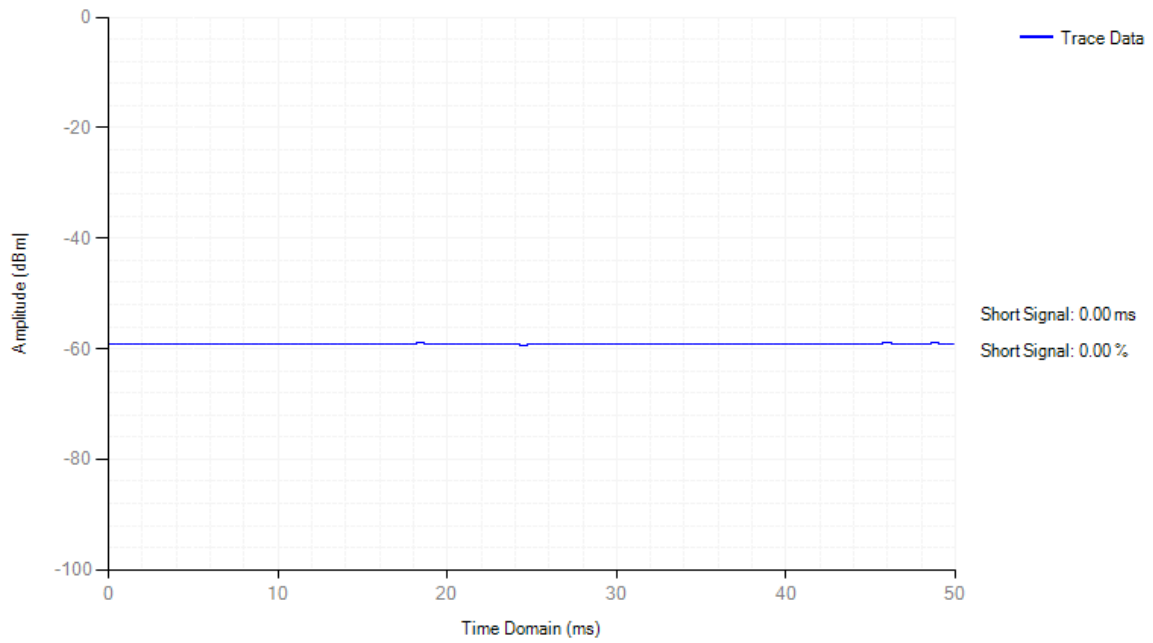

Adaptivity NVNT 802.11n(HT40) 5190MHz LTE

Adaptivity

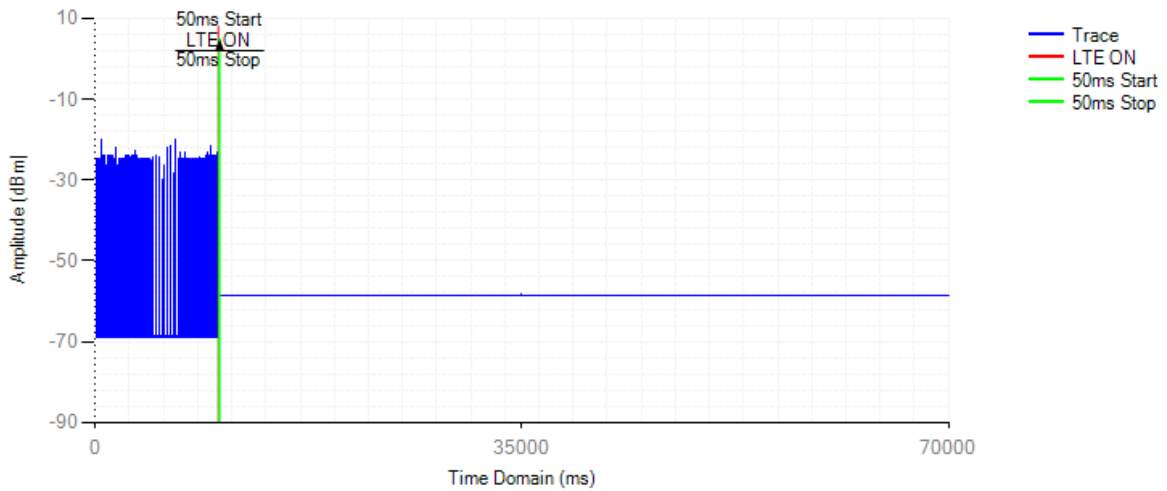

Control Signal NVNT 802.11n(HT40) 5190MHz LTE

Short Control Signal

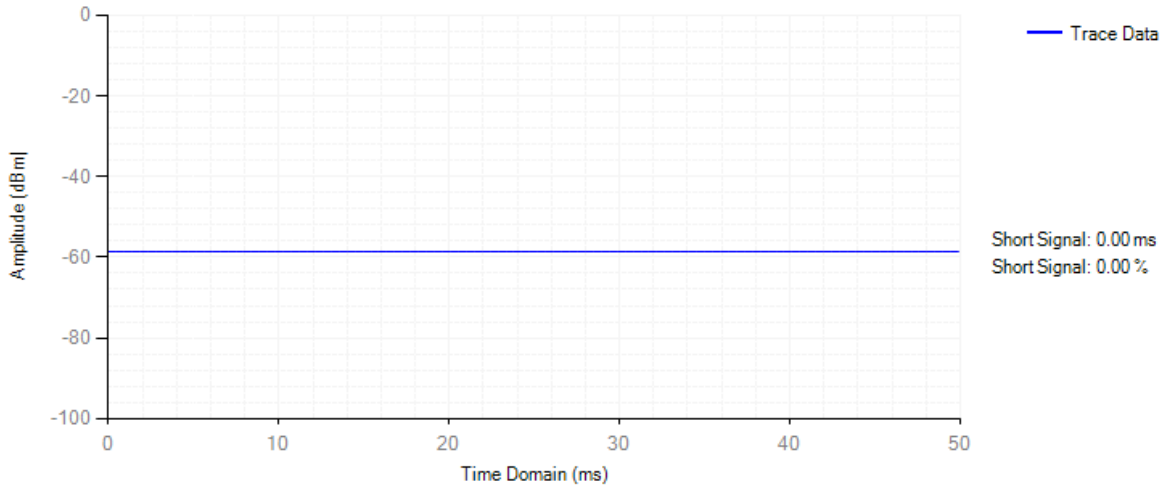

Adaptivity NVNT 802.11n(HT40) 5190MHz OFDM

Adaptivity

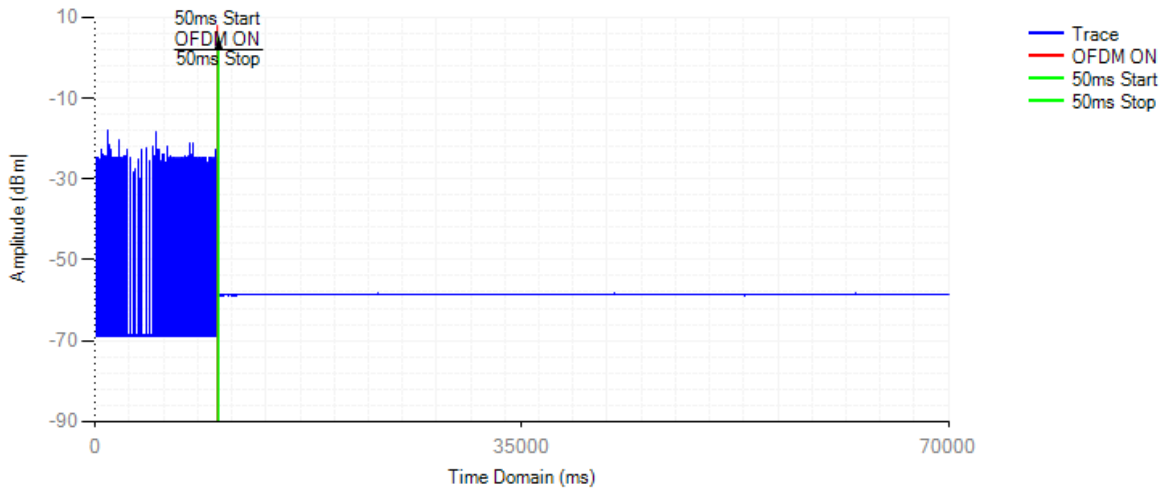

Control Signal NVNT 802.11n(HT40) 5190MHz OFDM

Short Control Signal

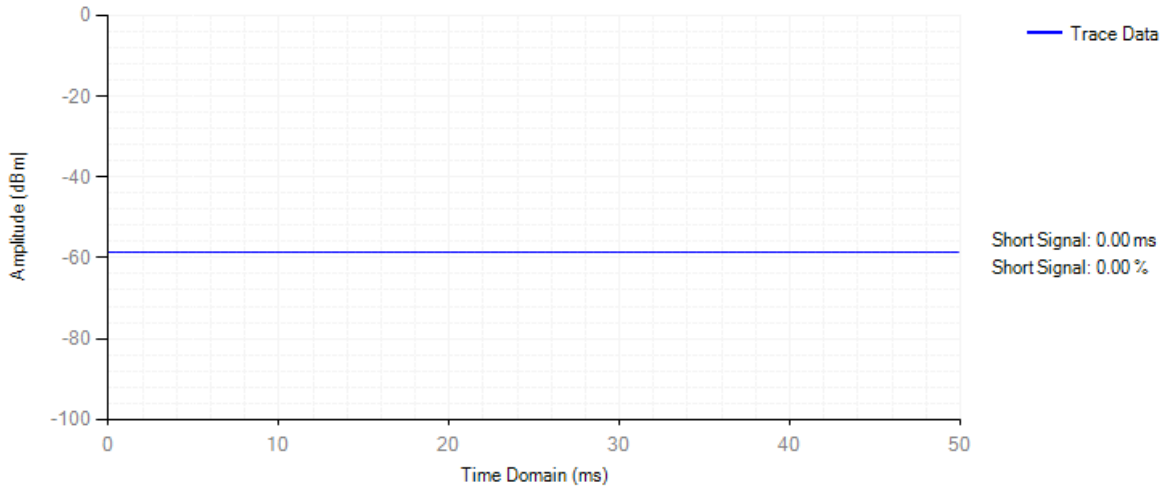

13.8 Adaptivity COT Channel Occupancy Time

Condition	Mode	Frequency (MHz)	Priority Class	Max COT (ms)	Limit COT (ms)	Min Idle Time (ms)	Limit Idle Time (ms)	Verdict
NVNT	802.11a	5180	1	0.16	≤6	0.045	>0.027	Pass
NVNT	802.11ac80	5210	1	0.805	≤6	0.035	>0.027	Pass
NVNT	802.11n(HT40)	5190	2	0.493	≤6	0.035	>0.027	Pass

COT NVNT 802.11a 5180MHz

Channel Occupation Time

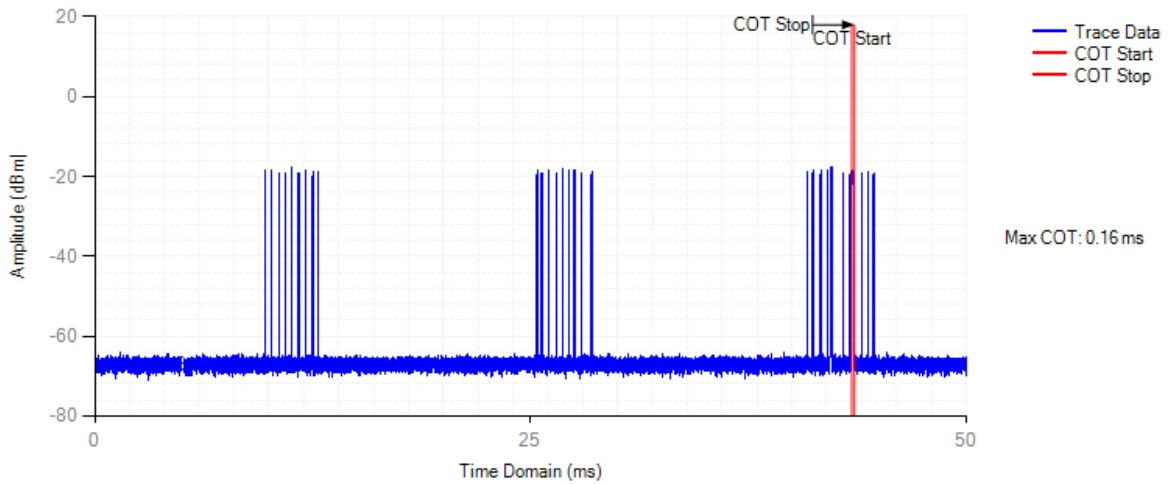

Idle NVNT 802.11a 5180MHz

Channel Occupation Time

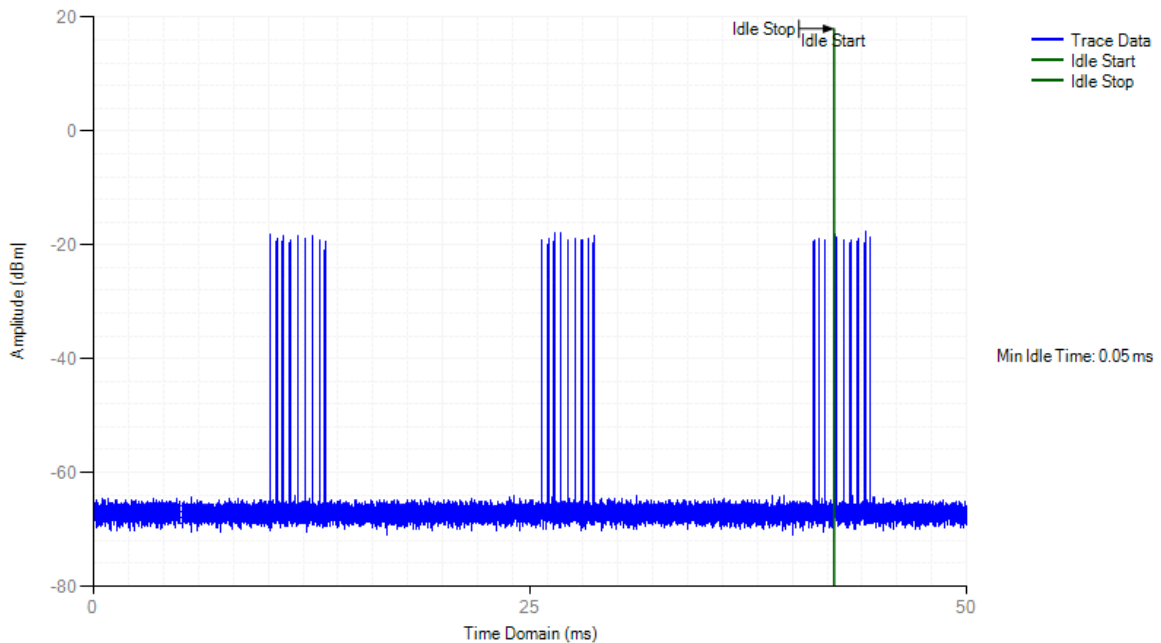

COT NVNT 802.11ac80 5210MHz

Channel Occupation Time

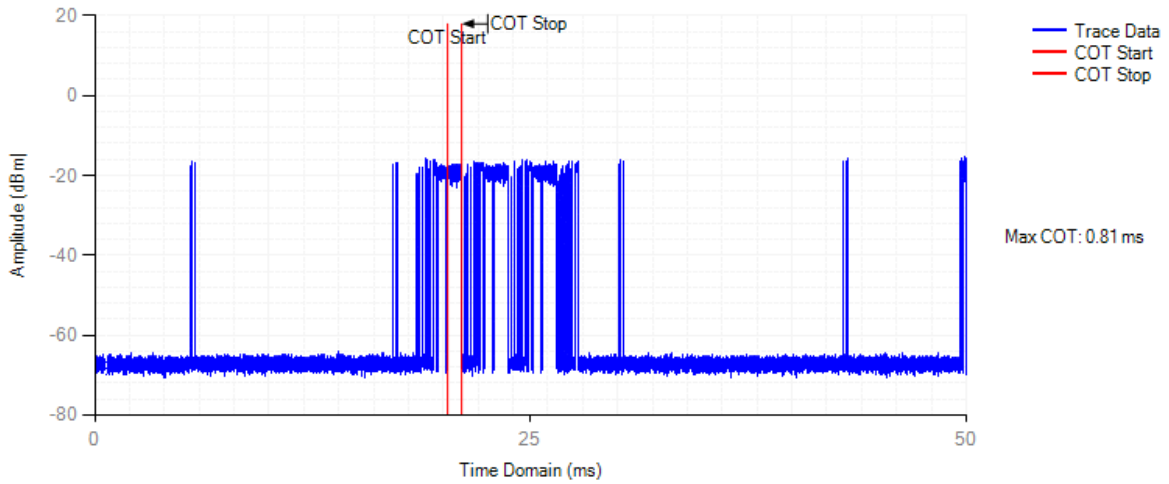

Idle NVNT 802.11ac80 5210MHz

Channel Occupation Time

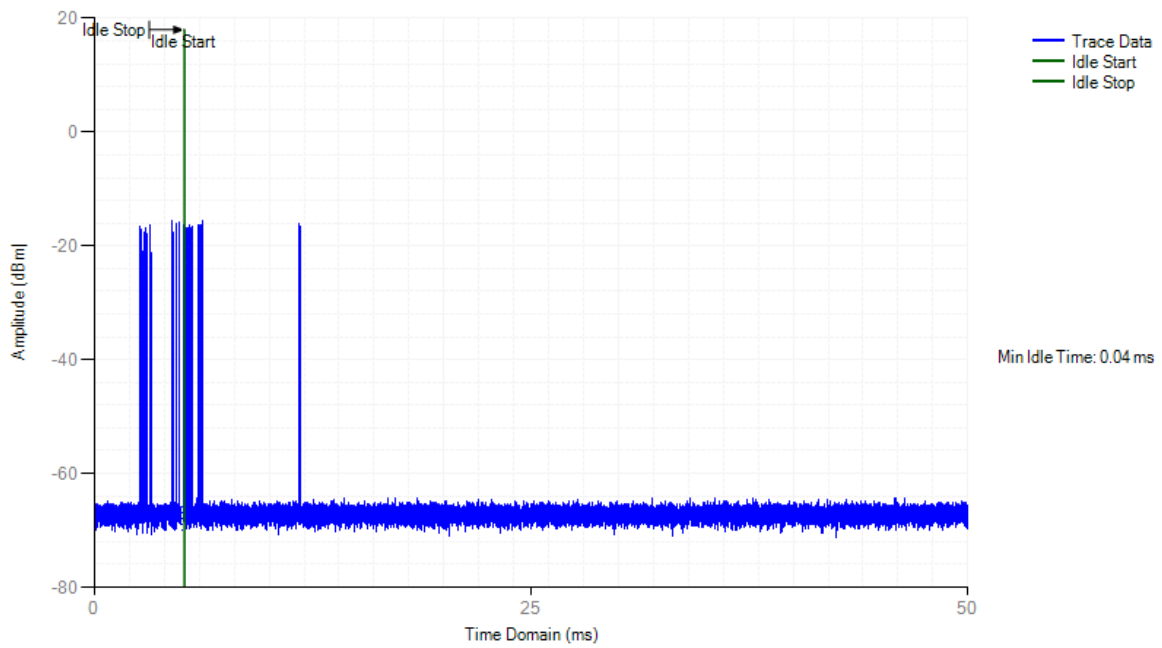

COT NVNT 802.11n(HT40) 5190MHz

Channel Occupation Time

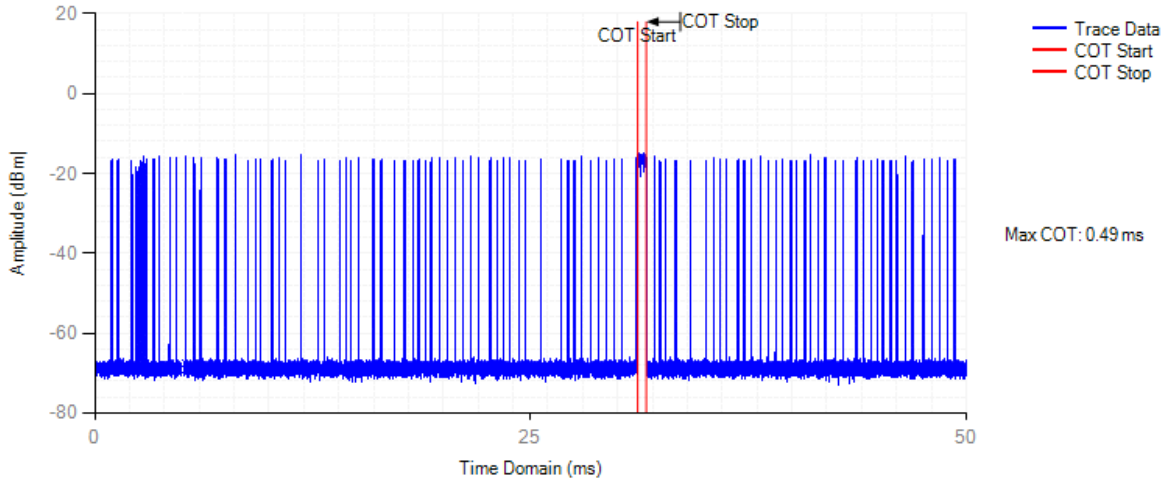

Idle NVNT 802.11n(HT40) 5190MHz

Channel Occupation Time

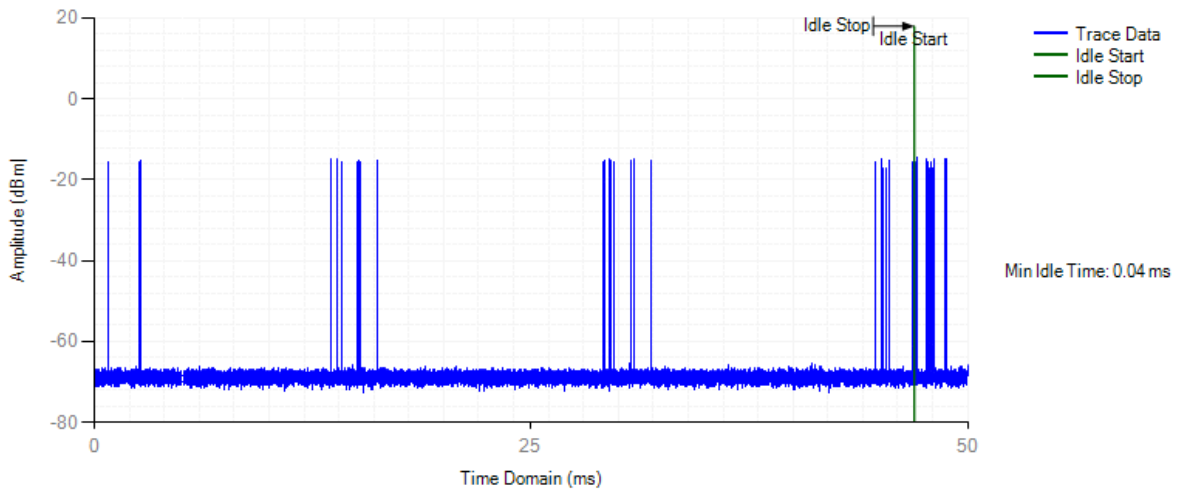

13.9 Adaptivity COT Idle Period Probability

Condition	Mode	Frequency (MHz)	Priority Class	Bn	H(Bn)	Pn (%)	Limit (%)	Verdict
NVNT	802.11a	5180	1	0	366	3.66	5	Pass
NVNT	802.11a	5180	1	1	1	3.67	12	Pass
NVNT	802.11a	5180	1	2	1	3.68	18.25	Pass
NVNT	802.11a	5180	1	3	1	3.69	24.5	Pass
NVNT	802.11a	5180	1	4	0	3.69	30.75	Pass
NVNT	802.11a	5180	1	5	0	3.69	37	Pass
NVNT	802.11a	5180	1	6	2	3.71	43.25	Pass
NVNT	802.11a	5180	1	7	0	3.71	49.5	Pass
NVNT	802.11a	5180	1	8	1	3.72	55.75	Pass
NVNT	802.11a	5180	1	9	0	3.72	62	Pass
NVNT	802.11a	5180	1	10	0	3.72	68.25	Pass
NVNT	802.11a	5180	1	11	0	3.72	74.5	Pass
NVNT	802.11a	5180	1	12	1	3.73	80.75	Pass
NVNT	802.11a	5180	1	13	0	3.73	87	Pass
NVNT	802.11a	5180	1	14	0	3.73	93.25	Pass
NVNT	802.11a	5180	1	15	1	3.74	99.5	Pass
NVNT	802.11a	5180	1	16	9636	100	100	Pass
NVNT	802.11ac80	5210	1	0	491	4.9	5	Pass
NVNT	802.11ac80	5210	1	1	7	5.97	12	Pass
NVNT	802.11ac80	5210	1	2	269	7.76	18.25	Pass
NVNT	802.11ac80	5210	1	3	254	10.2	24.5	Pass
NVNT	802.11ac80	5210	1	4	252	12.32	30.75	Pass
NVNT	802.11ac80	5210	1	5	232	15.43	37	Pass
NVNT	802.11ac80	5210	1	6	189	16.92	43.25	Pass
NVNT	802.11ac80	5210	1	7	219	18.11	49.5	Pass
NVNT	802.11ac80	5210	1	8	205	21.16	55.75	Pass
NVNT	802.11ac80	5210	1	9	200	23.25	62	Pass
NVNT	802.11ac80	5210	1	10	259	26.74	68.25	Pass
NVNT	802.11ac80	5210	1	11	240	27.14	74.5	Pass
NVNT	802.11ac80	5210	1	12	935	37.38	80.75	Pass
NVNT	802.11ac80	5210	1	13	433	41.8	87	Pass
NVNT	802.11ac80	5210	1	14	193	43.78	93.25	Pass
NVNT	802.11ac80	5210	1	15	220	45.99	99.5	Pass
NVNT	802.11ac80	5210	1	16	5413	100	100	Pass
NVNT	802.11n(HT40)	5190	2	0	478	4.77	5	Pass
NVNT	802.11n(HT40)	5190	2	1	10	4.87	12	Pass
NVNT	802.11n(HT40)	5190	2	2	7	4.94	18.25	Pass
NVNT	802.11n(HT40)	5190	2	3	24	5.18	24.5	Pass
NVNT	802.11n(HT40)	5190	2	4	6	5.24	30.75	Pass
NVNT	802.11n(HT40)	5190	2	5	3	5.27	37	Pass
NVNT	802.11n(HT40)	5190	2	6	204	7.3	43.25	Pass
NVNT	802.11n(HT40)	5190	2	7	190	9.2	49.5	Pass
NVNT	802.11n(HT40)	5190	2	8	204	11.24	55.75	Pass
NVNT	802.11n(HT40)	5190	2	9	213	13.36	62	Pass
NVNT	802.11n(HT40)	5190	2	10	159	14.95	68.25	Pass
NVNT	802.11n(HT40)	5190	2	11	182	16.76	74.5	Pass
NVNT	802.11n(HT40)	5190	2	12	146	18.22	80.75	Pass
NVNT	802.11n(HT40)	5190	2	13	148	19.7	87	Pass
NVNT	802.11n(HT40)	5190	2	14	167	21.37	93.25	Pass
NVNT	802.11n(HT40)	5190	2	15	132	22.68	99.5	Pass
NVNT	802.11n(HT40)	5190	2	16	7748	100	100	Pass

Idle Period Probability NVNT 802.11a 5180MHz

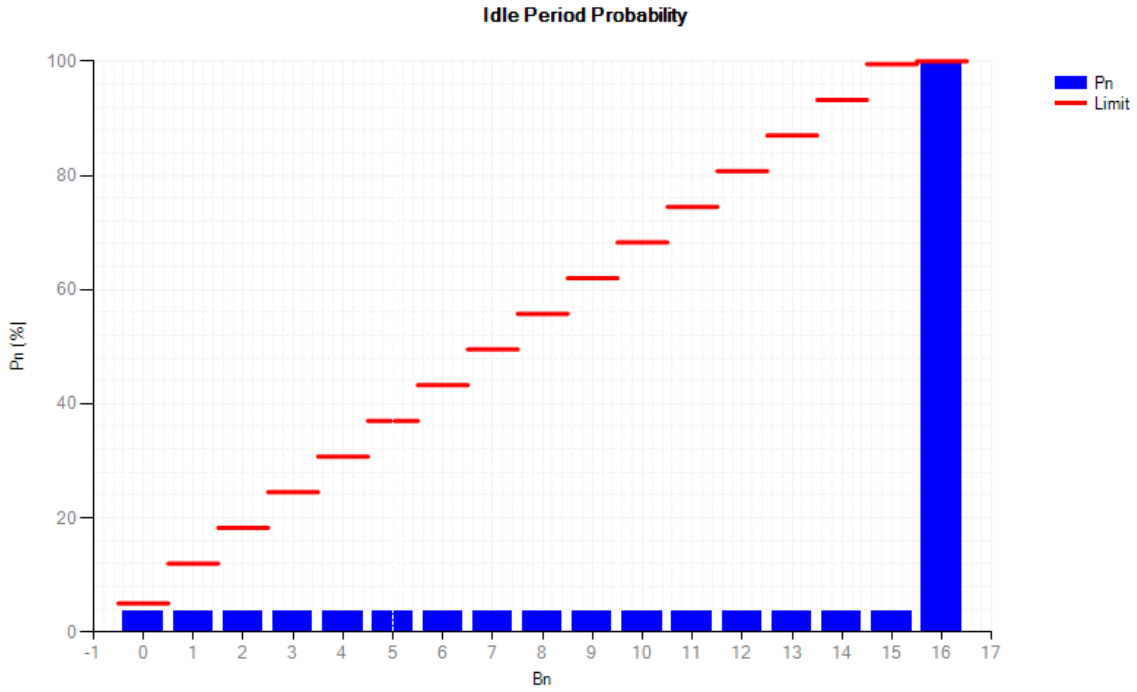

Idle Period Probability NVNT 802.11ac80 5210MHz

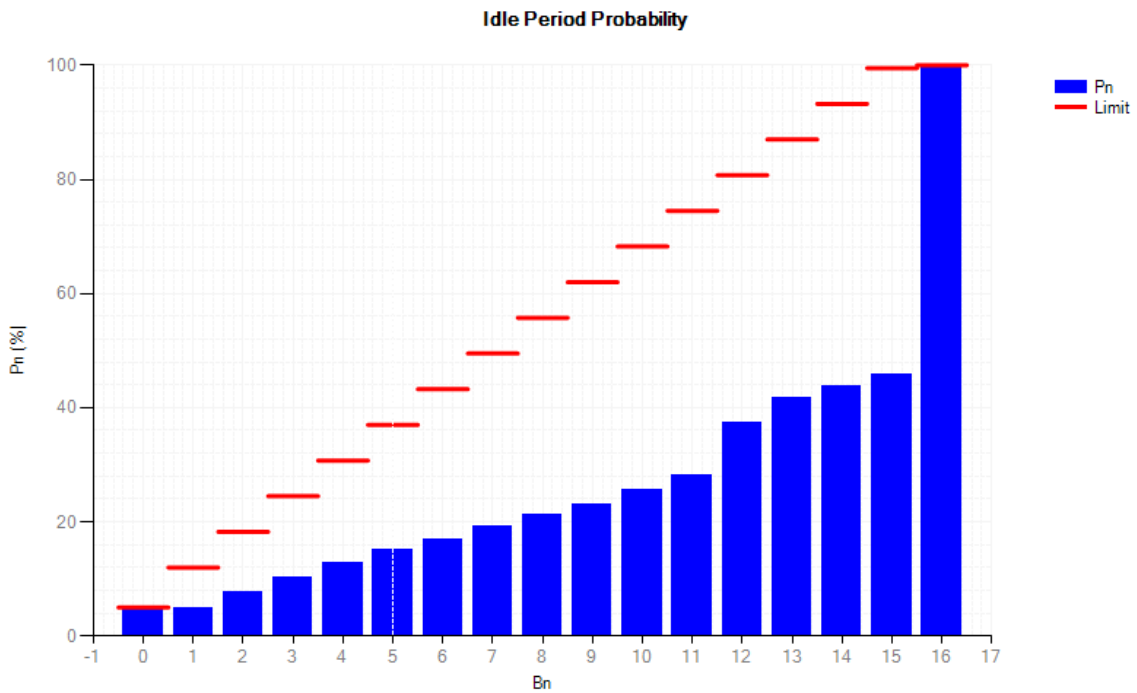

Idle Period Probability NVNT 802.11n(HT40) 5190MHz

Idle Period Probability

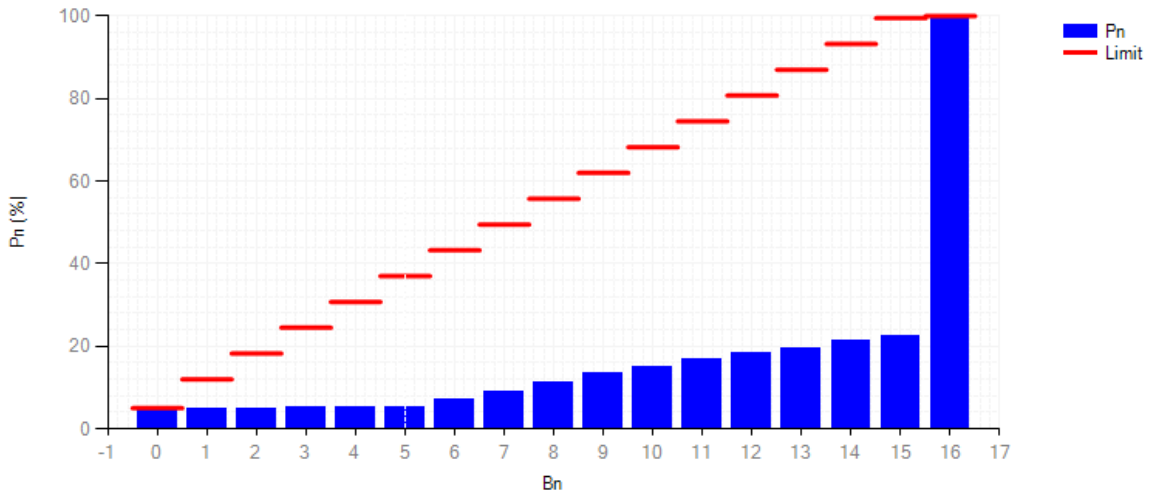

14. EUT TEST PHOTO

SPURIOUS EMISSIONS MEASUREMENT PHOTOS



END OF REPORT