

CE SAR EVALUATION REPORT

In accordance with the requirements of
**EN50360, EN50566, EN62209-1/-2, EN62479 and COUNCIL
RECOMMENDATION 1999/519/EC**

Product Name : Mobile Phone

Trademark : Blackview

Model Name : A85

Family Model : N/A

Report No. : STR22102801013E

Prepared for

DOKE COMMUNICATION (HK) LIMITED

RM 1902 EASEY COMM BLDG 253-261 HENNESSY ROAD WANCHAI HK CHINA

Prepared by

Shenzhen NTEK Testing Technology Co., Ltd.

1/F, Building E, Fenda Science Park, Sanwei Community, Xixiang Street,

Bao'an District, Shenzhen 518126 P.R.China.

Tel. 400-800-6106, 0755-2320 0050, 0755-2320 0090

Website: <http://www.ntek.org.cn>

TEST RESULT CERTIFICATION

Applicant's name : DOKE COMMUNICATION (HK) LIMITED
Address : RM 1902 EASEY COMM BLDG 253-261 HENNESSY ROAD
 WANCHAI HK CHINA
Manufacturer's Name : Shenzhen DOKE Electronic Co.,Ltd
Address : 801, Building3, 7th Industrial Zone, Yulv Community, Yutang Road,
 Guangming District, Shenzhen, China

Product description

Product name : Mobile Phone
Trademark : Blackview
Model and/or type reference . : A85
Family Model..... : N/A

EN 50360:2017;
 EN 50566:2017;

Standards : EN 62209-1:2016;
 EN 62209-2:2010;
 EN 62479:2010;

This device described above has been tested by Shenzhen NTEK. In accordance with the measurement methods and procedures specified in EN62209. Testing has shown that this device is capable of compliance with localized specific absorption rate (SAR) specified in COUNCIL 1999/519/EC. The test results in this report apply only to the tested sample of the stated device/equipment. Other similar device/equipment will not necessarily produce the same results due to production tolerance and measurement uncertainties.

This report shall not be reproduced except in full, without the written approval of Shenzhen NTEK, this document may be altered or revised by Shenzhen NTEK, personal only, and shall be noted in the revision of the document.

Test Sample Number T221028001R003

Date of Test

Date (s) of performance of tests Oct. 28, 2022 ~ Nov. 10, 2022

Date of Issue..... Nov. 17, 2022

Test Result..... **Pass**

Prepared By : Jacob Chen
 (Test Engineer) : (Jacob Chen)

Approved By : Alex
 (Lab Manager) : (Alex Li)

※ ※ Revision History ※ ※

REV.	DESCRIPTION	ISSUED DATE	REMARK
Rev.1.0	Initial Test Report Release	Nov. 17, 2022	Jacob Chen

TABLE OF CONTENTS

1. General Information	6
1.1. RF exposure limits.....	6
1.2. Statement of Compliance	7
1.3. EUT Description	7
1.4. Test specification(s)	9
1.5. Ambient Condition.....	9
2. SAR Measurement System	10
2.1. SATIMO SAR Measurement Set-up Diagram	10
2.2. Robot	11
2.3. E-Field Probe.....	12
2.3.1. E-Field Probe Calibration	12
2.4. SAM phantoms	13
2.4.1. Technical Data	14
2.5. Device Holder	15
2.6. Test Equipment List	16
3. SAR Measurement Procedures	18
3.1. Power Reference	18
3.2. Area scan & Zoom scan.....	18
3.3. Description of interpolation/extrapolation scheme	19
3.4. Volumetric Scan	19
3.5. Power Drift	19
4. System Verification Procedure	20
4.1. Tissue Verification	20
4.1.1. Tissue Dielectric Parameter Check Results	21
4.2. System Verification Procedure	22
4.2.1. System Verification Results	23
5. SAR Measurement Uncertainty	24
6. RF Exposure Positions	25
6.1. Ear and handset reference point	25
6.2. Definition of the cheek position	25
6.3. Definition of the tilt position	27
6.4. Body-worn device	27
7. RF Output Power	28
7.1. GSM Conducted Power	28
7.2. WCDMA Conducted Power	29
7.3. LTE Conducted Power	29
7.4. WLAN & Bluetooth Output Power	36
7.5. NFC Assessment.....	37
8. Assessment of the compliance of low power equipment.....	38

9. SAR Results	38
9.1. SAR measurement results	38
9.1.1. SAR measurement Result of GSM900	38
9.1.2. SAR measurement Result of GSM1800	39
9.1.3. SAR measurement Result of WCDMA Band 1	40
9.1.4. SAR measurement Result of WCDMA Band 8	40
9.1.5. SAR measurement Result of LTE Band 1	41
9.1.6. SAR measurement Result of LTE Band 3	42
9.1.7. SAR measurement Result of LTE Band 7	43
9.1.8. SAR measurement Result of LTE Band 8	44
9.1.9. SAR measurement Result of LTE Band 20	45
9.1.10. SAR measurement Result of LTE Band 40	46
9.1.11. SAR measurement Result of WLAN 2.4G	46
9.1.12. SAR measurement Result of WLAN 5.2G	47
9.1.13. SAR measurement Result of WLAN 5.8G	48
9.2. Simultaneous Transmission Analysis	49
9.3. Exposure Conditions	49
10. Appendix A. Photo documentation	51
11. Appendix B. System Check Plots	53
12. Appendix C. Plots of High SAR Measurement	70
13. Appendix D. Calibration Certificate	123

1. General Information

1.1. RF exposure limits

(A).Limits for Occupational/Controlled Exposure (W/kg)

Whole-Body	Partial-Body	Hands, Wrists, Feet and Ankles
0.4	10.0	20.0

(B).Limits for General Population/Uncontrolled Exposure (W/kg)

Whole-Body	Partial-Body	Hands, Wrists, Feet and Ankles
0.08	2.0	4.0

NOTE: **Whole-Body SAR** is averaged over the entire body, **partial-body SAR** is averaged over any 10 gram of tissue defined as a tissue volume in the shape of a cube.

SAR for hands, wrists, feet and ankles is averaged over any 10 grams of tissue defined as a tissue volume in the shape of a cube.

Occupational/Controlled Environments:

Are defined as locations where there is exposure that may be incurred by people who are aware of the potential for exposure, (i.e. as a result of employment or occupation).

General Population/Uncontrolled Environments:

Are defined as locations where there is the exposure of individuals who have no knowledge or control of their exposure.

NOTE

HEAD AND TRUNK LIMIT
2.0 W/kg AND MEMBER LIMIT 4.0 W/kg
APPLIED TO THIS EUT

1.2. Statement of Compliance

The maximum results of Specific Absorption Rate (SAR) found during testing for A85 are as follows.

RF Exposure Conditions	Max SAR Value(W/kg)		
	10-g Head	10-g Body & Hotspot (Separation distance of 5mm)	10-g Member DAS (See note ³) (Separation distance of 0mm)
	0.964	0.841	3.017
Max Simultaneous Tx	1.227	1.232	3.824

- NOTE: 1. The Max Simultaneous Tx is calculated based on the same configuration and test position.
 2. This device is in compliance with Specific Absorption Rate (SAR) for general population / uncontrolled exposure limits (2.0 W/kg for head and body, 4.0 W/kg for member) specified in COUNCIL RECOMMENDATION 1999/519/EC, and had been tested in accordance with the measurement methods and procedures specified in EN 62209-1:2016 & EN 62209-2:2010.
 3. The member DAS, It is only an assessment required by the ANFR (Sell to France).

1.3. EUT Description

Device Information			
Product Name	Mobile Phone		
Trademark	Blackview		
Model Name	A85		
Family Model	N/A		
Device Phase	Identical Prototype		
Exposure Category	General population / Uncontrolled environment		
Antenna Type	PIFA Antenna		
Battery Information	DC 3.85V, 4480mAh, 17.248Wh		
Hardware version	S681_V1		
Software version	A85_EEA_S6063_V1.1		
Device Operating Configurations			
Supporting Mode(s)	GSM 900/1800, WCDMA Band 1/8, LTE Band 1/3/7/8/20/40, WLAN 2.4G/5G, Bluetooth, GPS, FM, NFC		
Test Modulation	GSM(GMSK/8PSK), WCDMA(QPSK), LTE(QPSK/16-QAM), WLAN(DSSS/OFDM), Bluetooth(GFSK, π/4-DQPSK, 8DPSK), GPS(BPSK), FM(FM), NFC(ASK)		
Device Class	B		
Operating Frequency Range(s)	Band	Tx (MHz)	Rx (MHz)
	GSM 900	880-915	925-960
	GSM 1800	1710-1785	1805-1880
	WCDMA Band 1	1920-1980	2110-2170
	WCDMA Band 8	880-915	925-960

	LTE Band 1	1920-1980	2110-2170
	LTE Band 3	1710-1785	1805-1880
	LTE Band 7	2500-2570	2620-2690
	LTE Band 8	880- 915	925- 960
	LTE Band 20	832-862	791-821
	LTE Band 40	2300-2400	
	WLAN 2.4G	2412-2472	
	WLAN 5.2G	5180-5240	
	WLAN 5.8G	5745-5825	
	Bluetooth	2402-2480	
	NFC	13.56	
	FM	N/A	87.5-108
	GPS	N/A	1575.42
GPRS Multislot Class(12)	Max Number of Timeslots in Uplink		4
	Max Number of Timeslots in Downlink		4
	Max Total Timeslot		5
EGPRS Multislot Class(12)	Max Number of Timeslots in Uplink		4
	Max Number of Timeslots in Downlink		4
	Max Total Timeslot		5
Power Class	4, tested with power level 5(GSM 900)		
	1, tested with power level 0(GSM 1800)		
	3, tested with power control "all 1"(WCDMA Band 1)		
	3, tested with power control "all 1"(WCDMA Band 8)		
	3, tested with power control all Max.(LTE Band 1)		
	3, tested with power control all Max.(LTE Band 3)		
	3, tested with power control all Max.(LTE Band 7)		
	3, tested with power control all Max.(LTE Band 8)		
	3, tested with power control all Max.(LTE Band 20)		
	3, tested with power control all Max.(LTE Band 40)		

1.4. Test specification(s)

EN 50360:2017	Product standard to demonstrate the compliance of wireless communication devices, with the basic restrictions and exposure limit values related to human exposure to electromagnetic fields in the frequency range from 300 MHz to 6 GHz: devices used next to the ear
EN 50566:2017	Product standard to demonstrate the compliance of wireless communication devices with the basic restrictions and exposure limit values related to human exposure to electromagnetic fields in the frequency range from 30 MHz to 6 GHz: hand-held and body mounted devices in close proximity to the human body
EN 62209-1:2016	Measurement procedure for the assessment of specific absorption rate of human exposure to radio frequency fields from hand-held and body-mounted wireless communication devices - Part 1: Devices used next to the ear (Frequency range of 300 MHz to 6 GHz)
EN 62209-2:2010	Human exposure to radio frequency fields from hand-held and body-mounted wireless communication devices – Human models, instrumentation, and procedures –Part 2: Procedure to determine the Specific Absorption Rate (SAR) in the head and body for 30MHz to 6GHz Handheld and Body-Mounted Devices used in close proximity to the body
EN 62479:2010	Assessment of the compliance of low-power electronic and electrical equipment with the restrictions related to human exposure to electromagnetic fields(10 MHz to 300 GHz)

1.5. Ambient Condition

Ambient temperature	20°C – 24°C
Relative Humidity	30% – 70%

2. SAR Measurement System

2.1. SATIMO SAR Measurement Set-up Diagram

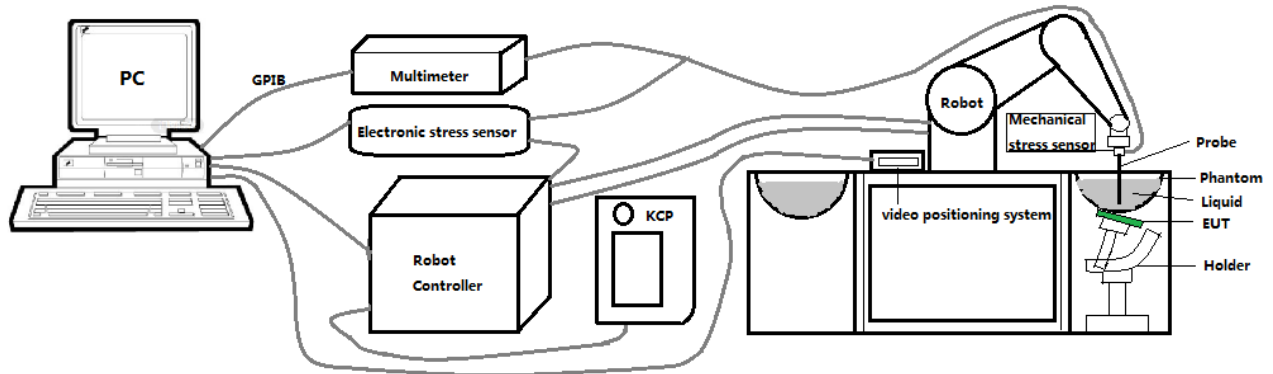

These measurements were performed with the automated near-field scanning system OPENSAR from SATIMO. The system is based on a high precision robot (working range: 901 mm), which positions the probes with a positional repeatability of better than ± 0.03 mm. The SAR measurements were conducted with dosimetric probe (manufactured by SATIMO), designed in the classical triangular configuration and optimized for dosimetric evaluation.

The first step of the field measurement is the evaluation of the voltages induced on the probe by the device under test. Probe diode detectors are nonlinear. Below the diode compression point, the output voltage is proportional to the square of the applied E-field; above the diode compression point, it is linear to the applied E-field. The compression point depends on the diode, and a calibration procedure is necessary for each sensor of the probe.

The Keithley multimeter reads the voltage of each sensor and send these three values to the PC. The corresponding E field value is calculated using the probe calibration factors, which are stored in the working directory. This evaluation includes linearization of the diode characteristics. The field calculation is done separately for each sensor. Each component of the E field is displayed on the "Dipole Area Scan Interface" and the total E field is displayed on the "3D Interface"

2.2. Robot

The SATIMO SAR system uses the high precision robots from KUKA. For the 6-axis controller system, the robot controller version (KUKA) from KUKA is used. The KUKA robot series have many features that are important for our application:



- High precision (repeatability ± 0.03 mm)
- High reliability (industrial design)
- Jerk-free straight movements
- Low ELF interference (the closed metallic construction shields against motor control fields)

2.3. E-Field Probe

This E-field detection probe is composed of three orthogonal dipoles linked to special Schottky diodes with low detection thresholds. The probe allows the measurement of electric fields in liquids such as the one defined in the IEEE and CENELEC standards.

For the measurements the Specific Dosimetric E-Field Probe SN 08/16 EPGO287 with following specifications is used



- Dynamic range: 0.01-100 W/kg
 - Tip Diameter : 2.5 mm
 - Distance between probe tip and sensor center: 1 mm
 - Distance between sensor center and the inner phantom surface: 2 mm (repeatability better than ± 1 mm).
 - Probe linearity: ± 0.08 dB
 - Axial isotropy: ± 0.01 dB
 - Hemispherical Isotropy: ± 0.01 dB
 - Calibration range: 650MHz to 5900MHz for head & body simulating liquid.
 - Lower detection limit: 8mW/kg
- Angle between probe axis (evaluation axis) and surface normal line: less than 30° .

2.3.1. E-Field Probe Calibration

Each probe needs to be calibrated according to a dosimetric assessment procedure with accuracy better than $\pm 10\%$. The spherical isotropy shall be evaluated and within ± 0.25 dB. The sensitivity parameters (Norm X, Norm Y, and Norm Z), the diode compression parameter (DCP) and the conversion factor (Conv F) of the probe are tested. The calibration data can be referred to appendix D of this report.

2.4. SAM phantoms

Photo of SAM phantom SN 16/15 SAM119



The SAM phantom is used to measure the SAR relative to people exposed to electro-magnetic field radiated by mobile phones.

2.4.1. Technical Data

Serial Number	Shell thickness	Filling volume	Dimensions	Positionner Material	Permittivity	Loss Tangent
SN 16/15 SAM119	2 mm ±0.2 mm	27 liters	Length:1000 mm Width:500 mm Height:200 mm	Gelcoat with fiberglass	3.4	0.02

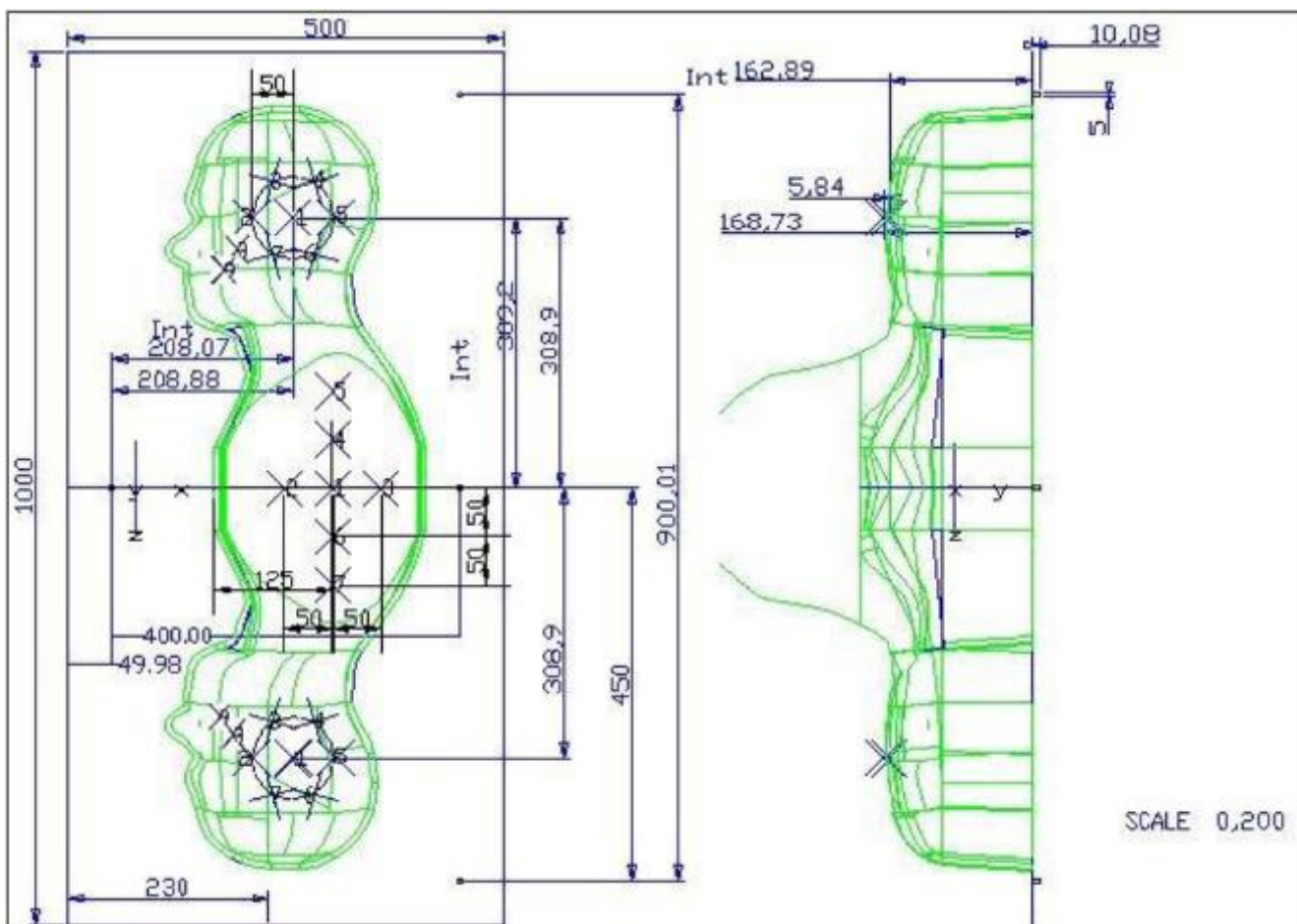

Serial Number	Left Head(mm)		Right Head(mm)		Flat Part(mm)	
	1	2	1	2	1	2
SN 16/15 SAM119	2	2.02	2	2.08	1	2.09
	3	2.05	3	2.06	2	2.06
	4	2.07	4	2.07	3	2.08
	5	2.08	5	2.08	4	2.10
	6	2.05	6	2.07	5	2.10
	7	2.05	7	2.05	6	2.07
	8	2.07	8	2.06	7	2.07
	9	2.08	9	2.06	-	-

The test, based on ultrasonic system, allows measuring the thickness with an accuracy of 10 µm.

2.5. Device Holder

The positioning system allows obtaining cheek and tilting position with a very good accuracy. In compliance with CENELEC, the tilt angle uncertainty is lower than 1 degree.

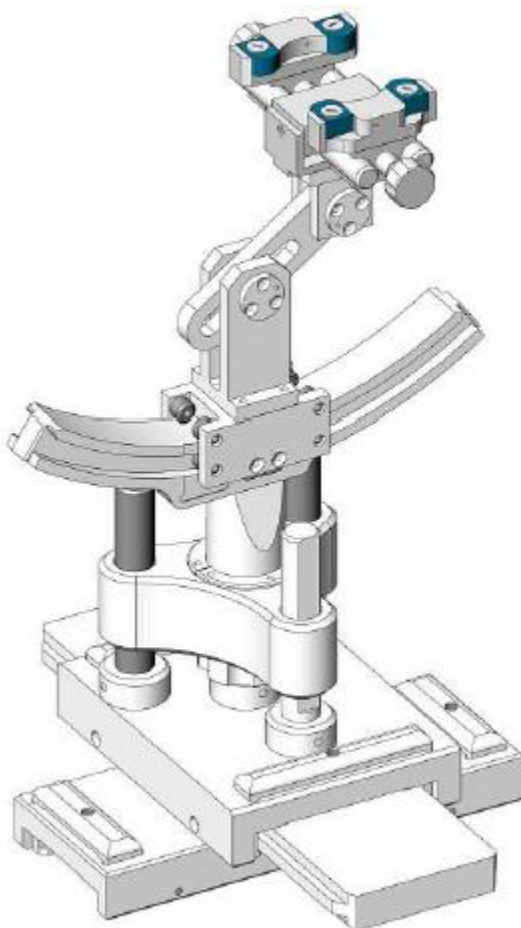

Serial Number	Holder Material	Permittivity	Loss Tangent
SN 16/15 MSH100	Delrin	3.7	0.005

2.6. Test Equipment List

This table gives a complete overview of the SAR measurement equipment.

Devices used during the test described are marked

	Manufacturer	Name of Equipment	Type/Model	Serial Number	Calibration	
					Last Cal.	Due Date
<input checked="" type="checkbox"/>	MVG	E FIELD PROBE	SSE2	SN 08/16 EPGO287	Feb. 01, 2022	Jan. 31, 2023
<input type="checkbox"/>	MVG	750 MHz Dipole	SID750	SN 03/15 DIP 0G750-355	Mar. 01, 2021	Feb. 28, 2024
<input type="checkbox"/>	MVG	835 MHz Dipole	SID835	SN 03/15 DIP 0G835-347	Mar. 01, 2021	Feb. 28, 2024
<input checked="" type="checkbox"/>	MVG	900 MHz Dipole	SID900	SN 03/15 DIP 0G900-348	Mar. 01, 2021	Feb. 28, 2024
<input checked="" type="checkbox"/>	MVG	1800 MHz Dipole	SID1800	SN 03/15 DIP 1G800-349	Mar. 01, 2021	Feb. 28, 2024
<input type="checkbox"/>	MVG	1900 MHz Dipole	SID1900	SN 03/15 DIP 1G900-350	Mar. 01, 2021	Feb. 28, 2024
<input checked="" type="checkbox"/>	MVG	2000 MHz Dipole	SID2000	SN 03/15 DIP 2G000-351	Mar. 01, 2021	Feb. 28, 2024
<input checked="" type="checkbox"/>	MVG	2300 MHz Dipole	SID2300	SN 03/16 DIP 2G300-358	Mar. 01, 2021	Feb. 28, 2024
<input checked="" type="checkbox"/>	MVG	2450 MHz Dipole	SID2450	SN 03/15 DIP 2G450-352	Mar. 01, 2021	Feb. 28, 2024
<input checked="" type="checkbox"/>	MVG	2600 MHz Dipole	SID2600	SN 03/15 DIP 2G600-356	Mar. 01, 2021	Feb. 28, 2024
<input checked="" type="checkbox"/>	MVG	5000 MHz Dipole	SWG5500	SN 13/14 WGA 33	Mar. 01, 2021	Feb. 28, 2024
<input checked="" type="checkbox"/>	MVG	Liquid measurement Kit	SCLMP	SN 21/15 OCPG 72	NCR	NCR
<input checked="" type="checkbox"/>	MVG	Power Amplifier	N.A	AMPLISAR_28/14_003	NCR	NCR
<input checked="" type="checkbox"/>	KEITHLEY	Millivoltmeter	2000	4072790	NCR	NCR
<input checked="" type="checkbox"/>	R&S	Universal radio communication tester	CMU200	117858	Jun. 17, 2022	Jun. 16, 2023
<input checked="" type="checkbox"/>	R&S	Wideband radio communication tester	CMW500	103917	Jun. 17, 2022	Jun. 16, 2023
<input checked="" type="checkbox"/>	HP	Network Analyzer	8753D	3410J01136	Jun. 17, 2022	Jun. 16, 2023

<input checked="" type="checkbox"/>	Agilent	MXG Vector Signal Generator	N5182A	MY47070317	Jun. 16, 2022	Jun. 15, 2023
<input checked="" type="checkbox"/>	Agilent	Power meter	E4419B	MY45102538	Jun. 17, 2022	Jun. 16, 2023
<input checked="" type="checkbox"/>	Agilent	Power sensor	E9301A	MY41495644	Jun. 17, 2022	Jun. 16, 2023
<input checked="" type="checkbox"/>	Agilent	Power sensor	E9301A	US39212148	Jun. 17, 2022	Jun. 16, 2023
<input checked="" type="checkbox"/>	MCLI/USA	Directional Coupler	CB11-20	0D2L51502	Jul. 17, 2020	Jul. 16, 2023

3. SAR Measurement Procedures

The measurement procedures are as follows:

- (a) Use base station simulator (if applicable) or engineering software to transmit RF power continuously (continuous Tx) in the middle channel.
- (b) Keep EUT to radiate maximum output power or 100% duty factor (if applicable)
- (c) Measure output power through RF cable and power meter.
- (d) Place the EUT in the positions as setup photos demonstrates.
- (e) Set scan area, grid size and other setting on the OPENSAR software.
- (f) Measure SAR transmitting at the middle channel for all applicable exposure positions.
- (g) Identify the exposure position and device configuration resulting the highest SAR
- (h) Measure SAR at the lowest and highest channels at the worst exposure position and device configuration.

According to the test standard, the recommended procedure for assessing the peak spatial-average SAR value consists of the following steps:

- (a) Power reference measurement
- (b) Area scan
- (c) Zoom scan
- (d) Power drift measurement

3.1. Power Reference

The Power Reference Measurement and Power Drift Measurements are for monitoring the power drift of the device under test in the batch process. The minimum distance of probe sensors to surface determines the closest measurement point to phantom surface. This distance cannot be smaller than the distance of sensor calibration points to probe tip as defined in the probe properties.

3.2. Area scan & Zoom scan

The area scan is a 2D scan to find the hot spot location on the DUT. The zoom scan is a 3D scan above the hot spot to calculate the 1g and 10g SAR value.

Measurement of the SAR distribution with a grid of 8 to 16 mm * 8 to 16 mm and a constant distance to the inner surface of the phantom. Since the sensors cannot directly measure at the inner phantom surface, the values between the sensors and the inner phantom surface are extrapolated. With these values the area of the maximum SAR is calculated by an interpolation scheme. Around this point, a cube of 30 * 30 * 30 mm or 32 * 32 * 32 mm is assessed by measuring 5 or 8 * 5 or 8 * 4 or 5 mm. With these data, the peak spatial-average SAR value can be calculated.

From the scanned SAR distribution, identify the position of the maximum SAR value, in addition identify the positions of any local maxima with SAR values within 2 dB of the maximum value that will not be within the zoom scan of other peaks; additional peaks shall be measured only when the primary peak is within 2 dB of the SAR compliance limit (e.g., 1 W/kg for 1,6 W/kg 1 g limit, or 1,26 W/kg for 2 W/kg, 10 g limit).

3.3. Description of interpolation/extrapolation scheme

The local SAR inside the phantom is measured using small dipole sensing elements inside a probe body. The probe tip must not be in contact with the phantom surface in order to minimise measurements errors, but the highest local SAR will occur at the surface of the phantom.

An extrapolation is used to determine these highest local SAR values. The extrapolation is based on a fourth-order least-square polynomial fit of measured data. The local SAR value is then extrapolated from the liquid surface with a 1 mm step.

The measurements have to be performed over a limited time (due to the duration of the battery) so the step of measurement is high. It could vary between 5 and 8 mm. To obtain an accurate assessment of the maximum SAR averaged over 10 grams and 1 gram requires a very fine resolution in the three dimensional scanned data array.

3.4. Volumetric Scan

The volumetric scan consists of a full 3D scan over a specific area. This 3D scan is useful for multi Tx SAR measurement. Indeed, it is possible with OpenSAR to add, point by point, several volumetric scans to calculate the SAR value of the combined measurement as it is defined in the standard IEEE1528 and IEC62209.

3.5. Power Drift

All SAR testing is under the EUT installed with a full charged battery and transmit maximum output power. In OpenSAR measurement software, the power reference measurement and power drift measurement procedures are used for monitoring the power drift of EUT during SAR test. Both these procedures measure the field at a specified reference position before and after the SAR testing. The software will calculate the field difference in V/m. If the power drifts more than $\pm 5\%$, the SAR will be retested.

4. System Verification Procedure

4.1. Tissue Verification

The following tissue formulations are provided for reference only as some of the parameters have not been thoroughly verified. The composition of ingredients may be modified accordingly to achieve the desired target tissue parameters required for routine SAR evaluation.

Ingredients (% of weight)	Head Tissue								
	750	835	900	1800	1900	2000	2450	2600	5000
Frequency Band (MHz)	750	835	900	1800	1900	2000	2450	2600	5000
Water	34.40	34.40	34.40	55.36	55.36	71.88	71.88	71.88	65.53
NaCl	0.79	0.79	0.79	0.35	0.35	0.16	0.16	0.16	0.00
1,2-Propanediol	64.81	64.81	64.81	0.00	0.00	0.00	0.00	0.00	0.00
Triton X-100	0.00	0.00	0.00	30.45	30.45	19.97	19.97	19.97	17.24
DGBE	0.00	0.00	0.00	13.84	13.84	7.99	7.99	7.99	0.00

For SAR measurement of the field distribution inside the phantom, the phantom must be filled with homogeneous tissue simulating liquid to a depth of at least 15 cm. For head SAR testing, the liquid depth from the ear reference point (ERP) of the phantom to the liquid top surface is larger than 15 cm.

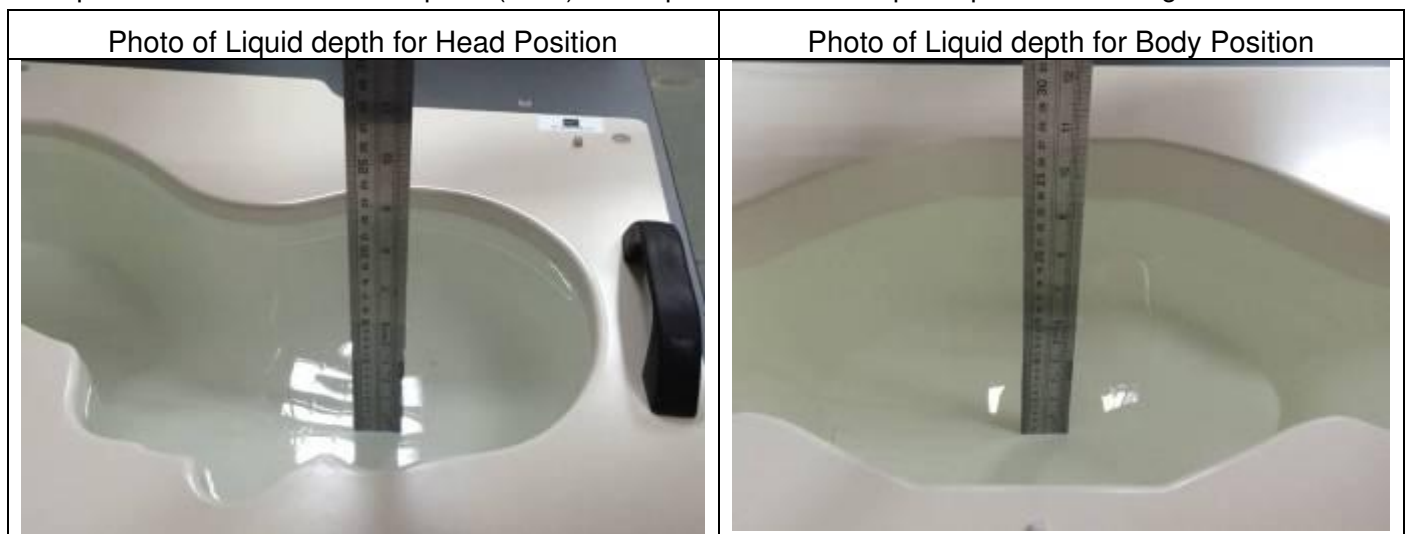

4.1.1. Tissue Dielectric Parameter Check Results

The simulating liquids should be checked at the beginning of a series of SAR measurements to determine of the dielectric parameter are within the tolerances of the specified target values. The measured conductivity and relative permittivity should be within $\pm 5\%$ of the target values.

Tissue Type	Measured Frequency (MHz)	Target Tissue		Measured Tissue		Liquid Temp.	Test Date
		ϵ_r ($\pm 5\%$)	σ (S/m) ($\pm 5\%$)	ϵ_r	σ (S/m)		
Head 900	900	41.50 (39.43~43.58)	0.97 (0.92~1.02)	39.86	0.97	21.6 °C	Nov. 07, 2022
Head 1800	1800	40.00 (38.00~42.00)	1.40 (1.33~1.47)	38.62	1.38	21.8 °C	Oct. 28, 2022
Head 2000	2000	40.00 (38.00~42.00)	1.40 (1.33~1.47)	39.51	1.39	21.6 °C	Nov. 08, 2022
Head 2300	2300	39.47 (37.50~41.44)	1.66 (1.58~1.74)	37.84	1.67	21.5 °C	Nov. 09, 2022
Head 2450	2450	39.20 (37.24~41.16)	1.80 (1.71~1.89)	37.57	1.77	21.9 °C	Nov. 01, 2022
Head 2600	2600	39.01 (37.06~40.96)	1.96 (1.86~2.06)	37.83	1.95	21.7 °C	Nov. 10, 2022
Head 5200	5200	36.00 (34.20~37.80)	4.66 (4.43~4.89)	35.51	4.67	21.2 °C	Nov. 04, 2022
Head 5800	5800	35.30 (33.54~37.07)	5.27 (5.01~5.53)	34.08	5.08	21.9 °C	Nov. 05, 2022

NOTE: The dielectric parameters of the tissue-equivalent liquid should be measured under similar ambient conditions and within 2 °C of the conditions expected during the SAR evaluation to satisfy protocol requirements.

4.2. System Verification Procedure

The system verification is performed for verifying the accuracy of the complete measurement system and performance of the software. The dipole is connected to the signal source consisting of signal generator and amplifier via a directional coupler, N-connector cable and adaption to SMA. It is fed with a power of 100mW (below 5GHz) or 100mW (above 5GHz). To adjust this power a power meter is used. The power sensor is connected to the cable before the system verification to measure the power at this point and do adjustments at the signal generator. At the outputs of the directional coupler both return loss as well as forward power are controlled during the system verification to make sure that emitted power at the dipole is kept constant. This can also be checked by the power drift measurement after the test (result on plot).

The system verification is shown as below picture:

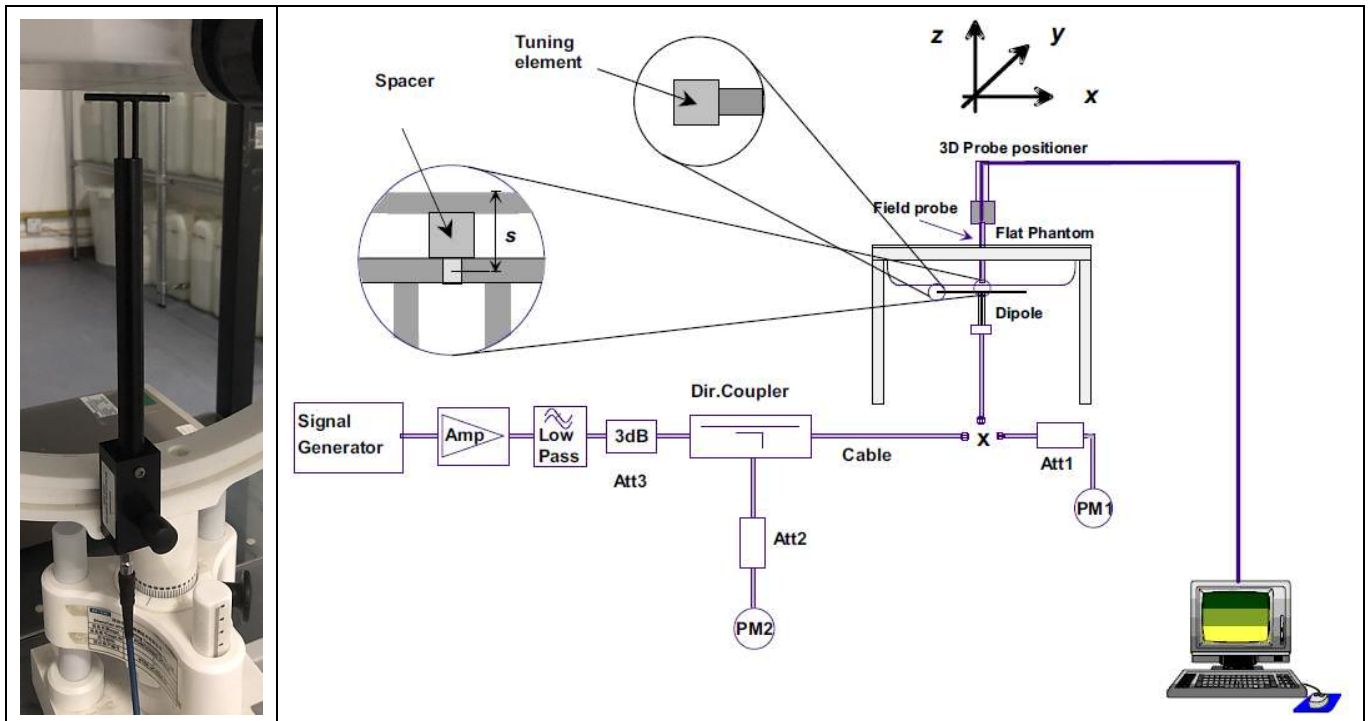

4.2.1. System Verification Results

Comparing to the original SAR value provided by SATIMO, the verification data should be within its specification of $\pm 10\%$. Below table shows the target SAR and measured SAR after normalized to 1W input power. The table below indicates the system performance verification can meet the variation criterion and the plots can be referred to Appendix B of this report.

System Verification	Target SAR (1W) ($\pm 10\%$)		Measured SAR (Normalized to 1W)		Liquid Temp.	Test Date
	1-g (W/Kg)	10-g (W/Kg)	1-g (W/Kg)	10-g (W/Kg)		
900MHz	11.08 (9.98~12.18)	6.81 (6.13~7.49)	11.07	7.22	21.6 °C	Nov. 07, 2022
1800MHz	37.96 (34.17~41.75)	19.81 (17.83~21.79)	34.31	20.54	21.8 °C	Oct. 28, 2022
2000MHz	41.26 (37.14~45.38)	20.52 (18.47~22.57)	44.88	19.48	21.6 °C	Nov. 08, 2022
2300MHz	50.65 (45.59~55.71)	23.55 (21.20~25.90)	50.95	23.90	21.5 °C	Nov. 09, 2022
2450MHz	53.69 (48.33~59.05)	23.94 (21.55~26.33)	56.95	23.32	21.9 °C	Nov. 01, 2022
2600MHz	55.83 (50.25~61.41)	24.19 (21.78~26.60)	50.70	26.25	21.7 °C	Nov. 10, 2022
5200MHz	162.34 (146.11~178.57)	55.42 (49.88~60.96)	157.16	55.84	21.2 °C	Nov. 04, 2022
5800MHz	178.89 (161.01~196.77)	59.32 (53.39~65.25)	190.77	60.90	21.9 °C	Nov. 05, 2022

5. SAR Measurement Uncertainty

The following measurement uncertainty levels have been estimated for tests performed on the EUT as specified in IEEE 1528: 2003. This uncertainty represents an expanded uncertainty expressed at approximately the 95% confidence level using a coverage factor of $k=2$.

Uncertainty Component	Tol. (±%)	Prob. Dist.	Div.	Ci (1 g)	Ci (10 g)	1 g Ui (±%)	10 g Ui (±%)	Vi
Measurement System <input type="checkbox"/>								
Probe Calibration	5.8	N	1	1	1	5.80	5.80	∞
Axial Isotropy	3.5	R	√3	0.97	0.97	1.98	1.98	∞
Hemispherical Isotropy	5.9	R	√3	0.28	0.28	0.96	0.96	∞
Boundary Effect	1	R	√3	1	1	0.58	0.58	∞
Linearity	4.7	R	√3	1	1	2.71	2.71	∞
System Detection Limits	1	R	√3	1	1	0.58	0.58	∞
Modulation response	3	N	1	1	1	3.00	3.00	∞
Readout Electronics	0.5	N	1	1	1	0.50	0.50	∞
Response Time	0	R	√3	1	1	0.00	0.00	∞
Integration Time	1.4	R	√3	1	1	0.81	0.81	∞
RF Ambient Conditions - Noise	3	R	√3	1	1	1.73	1.73	∞
RF Ambient Conditions - Reflections	3	R	√3	1	1	1.73	1.73	∞
Probe Positioner Mechanical Tolerance	1.4	R	√3	1	1	0.81	0.81	∞
Probe Positioning with respect to Phantom Shell	1.4	R	√3	1	1	0.81	0.81	∞
Extrapolation, interpolation and Integration Algorithms for Max. SAR Evaluation	2.3	R	√3	1	1	1.33	1.33	∞
Test sample Related								
Test Sample Positioning	2.6	N	1	1	1	2.60	2.60	11
Device Holder Uncertainty	3	N	1	1	1	3.00	3.00	7
Output Power Variation - SAR drift measurement	5	R	√3	1	1	2.89	2.89	∞
SAR scaling	2	R	√3	1	1	1.15	1.15	∞
Phantom and Tissue Parameters <input type="checkbox"/>								
Phantom Uncertainty (shape and thickness tolerances)	4	R	√3	1	1	2.31	2.31	∞
Uncertainty in SAR correction for deviation (in permittivity and conductivity)	2	N	1	1	0.84	2.00	1.68	∞
Liquid Conductivity (temperature uncertainty)	2.5	N	1	0.78	0.71	1.95	1.78	∞
Liquid conductivity - measurement uncertainty	1.59	N	1	0.23	0.26	0.37	0.41	99
Liquid permittivity (temperature uncertainty)	2.5	N	1	0.78	0.71	1.95	1.78	∞
Liquid permittivity - measurement uncertainty	1.65	N	1	0.23	0.26	0.38	0.43	99
Combined Standard Uncertainty		RSS				10.19	10.02	
Expanded Uncertainty (95% Confidence interval)		k				20.38	20.04	

6. RF Exposure Positions

6.1. Ear and handset reference point

Figure 6.1.1 shows the front, back, and side views of the SAM phantom. The center-of-mouth reference point is labeled “M”, the left ear reference point (ERP) is marked “LE”, and the right ERP is marked “RE”.



Fig 6.1.1 Front, back, and side views of SAM phantom

6.2. Definition of the cheek position

1. Define two imaginary lines on the handset, the vertical centerline and the horizontal line. The vertical centerline passes through two points on the front side of the handset: the midpoint of the width w_t of the handset at the level of the acoustic output (point A in Figure 6.2.1 and Figure 6.2.2), and the midpoint of the width w_b of the bottom of the handset (point B). The horizontal line is perpendicular to the vertical centerline and passes through the center of the acoustic output (see Figure 6.2.1). The two lines intersect at point A. Note that for many handsets, point A coincides with the center of the acoustic output; however, the acoustic output may be located elsewhere on the horizontal line. Also note that the vertical centerline is not necessarily parallel to the front face of the handset (see Figure 6.2.2), especially for clamshell handsets, handsets with flip covers, and other irregularly-shaped handsets.
2. Position the handset close to the surface of the phantom such that point A is on the (virtual) extension of the line passing through points RE and LE on the phantom (see Figure 6.2.3), such that the plane defined by the vertical centerline and the horizontal line of the handset is approximately parallel to the sagittal plane of the phantom.
3. Translate the handset towards the phantom along the line passing through RE and LE until handset point A touches the pinna at the ERP
4. While maintaining the handset in this plane, rotate it around the LE-RE line until the vertical centerline is in the plane normal to the plane containing B-M and N-F lines, i.e., the Reference Plane.
5. Rotate the handset around the vertical centerline until the handset (horizontal line) is parallel to the N-F line.

6. While maintaining the vertical centerline in the Reference Plane, keeping point A on the line passing through RE and LE, and maintaining the handset contact with the pinna, rotate the handset about the N-F line until any point on the handset is in contact with a phantom point below the pinna on the cheek. See Figure 6.2.3. The actual rotation angles should be documented in the test report.

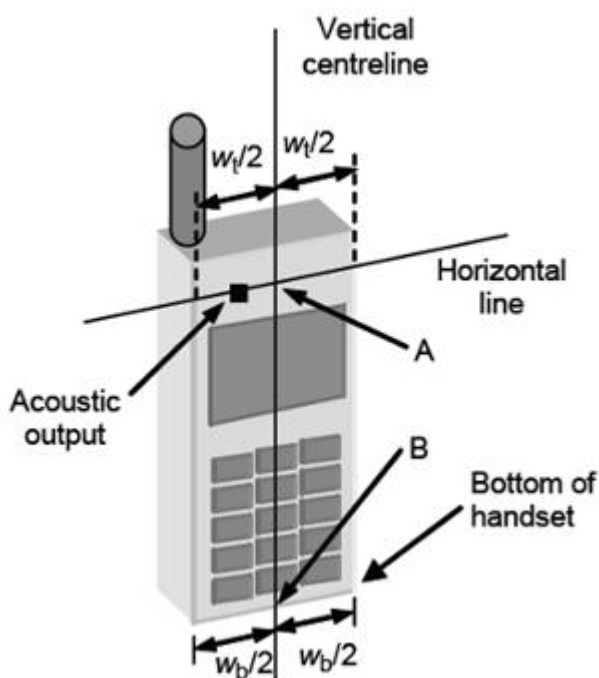

Fig 6.2.1 Handset vertical and horizontal reference lines—“fixed case”

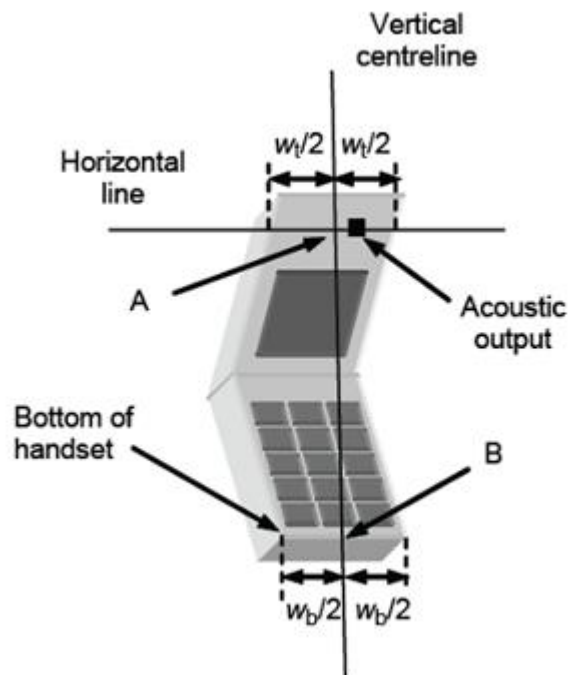

Fig 6.2.2 Handset vertical and horizontal reference lines—“clam-shell case”

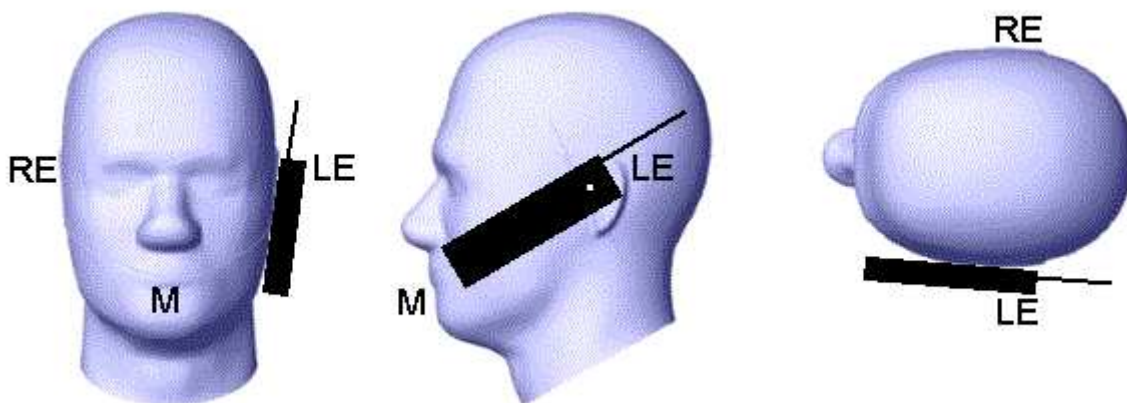

Fig 6.2.3 cheek or touch position. The reference points for the right ear (RE), left ear (LE), and mouth (M), which establish the Reference Plane for handset positioning, are indicated.

6.3. Definition of the tilt position

1. While maintaining the orientation of the handset, retract the handset parallel to the reference plane far enough away from the phantom to enable a rotation of the device by 15 degree.
2. Rotate the Handset around the horizontal line by 15 degree (see Figure 6.3.1).
3. While maintaining the orientation of the handset, move the handset towards the phantom on a line passing through RE and LE until any part of the handset touches the ear. The tilt position is obtained when the contact is on the pinna. If the contact is at any location other than the pinna, e.g., the antenna with the back of the phantom head, the angle of the handset shall be reduced. In this case, the tilt position is obtained if any part of the handset is in contact with the pinna as well as a second part of the handset is in contact with the phantom, e.g., the antenna with the back of the head.

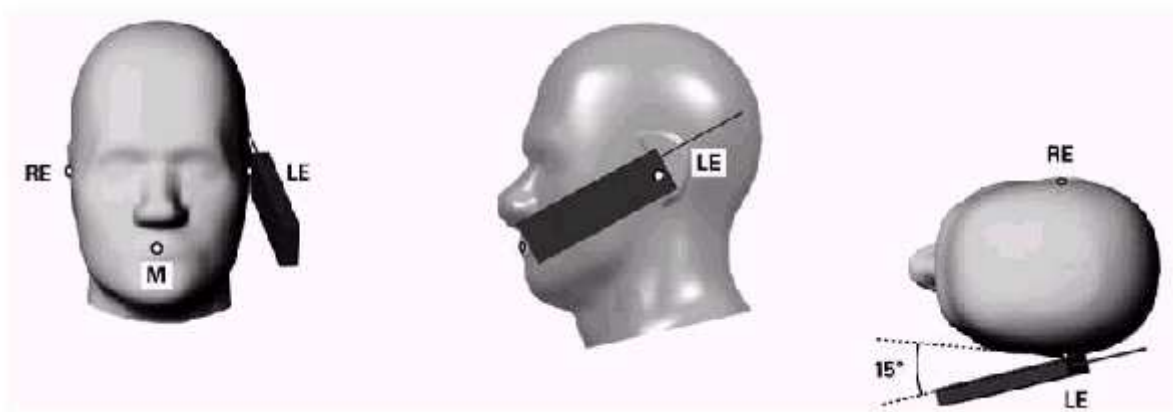

Figure 6.3.1 – Tilt position of the wireless device on the left side of SAM

6.4. Body-worn device

A typical example of a body-worn device is a mobile phone, wireless enabled PDA or other battery operated wireless device with the ability to transmit while mounted on a person's body using a carry accessory approved by the wireless device manufacturer. The device shall be positioned as intended at the distance to the outer surface of the phantom that corresponds to the specified distance (See figure 6.1). Adjust the distance between the device surface and the flat phantom to 5mm.

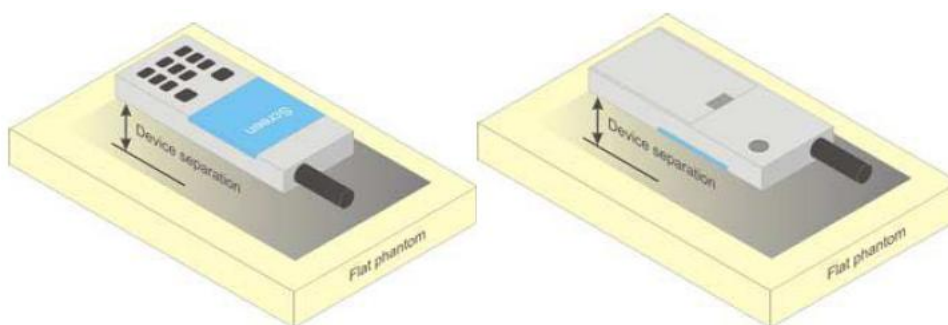

Figure 6.1 – Test positions for Body-worn device

7. RF Output Power

7.1. GSM Conducted Power

Band GSM900		Burst-Averaged output Power (dBm)			Frame-Averaged output Power (dBm)			
Tx Channel	Tune - up (dBm)	975	38	124	Tune -	975	38	124
Frequency (MHz)		880.2	897.6	914.8	up (dBm)	880.2	897.6	914.8
GSM Voice(GMSK)	33.50	32.70	33.02	33.18	24.47	23.67	23.99	24.15
GPRS(GMSK, 1 TS)	33.50	33.02	33.04	33.03	24.47	23.99	24.01	24.00
GPRS(GMSK, 2 TS)	32.50	32.39	32.40	32.42	26.48	26.37	26.38	26.40
GPRS(GMSK, 3 TS)	31.00	30.86	30.83	30.88	26.74	26.60	26.57	26.62
GPRS(GMSK, 4 TS)	30.00	29.63	29.60	29.65	26.99	26.62	26.59	26.64
EGPRS(8PSK, 1 TS)	25.50	24.99	25.09	25.44	16.47	15.96	16.06	16.41
EGPRS(8PSK, 2 TS)	25.00	24.54	24.61	24.98	18.98	18.52	18.59	18.96
EGPRS(8PSK, 3 TS)	23.00	22.16	22.15	22.52	18.74	17.90	17.89	18.26
EGPRS(8PSK, 4 TS)	21.50	20.97	20.89	21.30	18.49	17.96	17.88	18.29
Band GSM1800		Burst-Averaged output Power (dBm)			Frame-Averaged output Power (dBm)			
Tx Channel	Tune - up (dBm)	512	698	885	Tune -	512	698	885
Frequency (MHz)		1710.2	1747.4	1784.8	up (dBm)	1710.2	1747.4	1784.8
GSM Voice(GMSK)	30.00	29.82	29.71	29.28	20.97	20.79	20.68	20.25
GPRS(GMSK, 1 TS)	30.00	29.85	29.73	29.30	20.97	20.82	20.70	20.27
GPRS(GMSK, 2 TS)	29.50	29.25	29.23	28.75	23.48	23.23	23.21	22.73
GPRS(GMSK, 3 TS)	28.00	27.53	27.42	26.98	23.74	23.27	23.16	22.72
GPRS(GMSK, 4 TS)	27.00	26.50	26.37	25.92	23.99	23.49	23.36	22.91
EGPRS(8PSK, 1 TS)	25.50	25.25	25.36	25.47	16.47	16.22	16.33	16.44
EGPRS(8PSK, 2 TS)	25.00	24.84	24.87	25.00	18.98	18.82	18.85	18.98
EGPRS(8PSK, 3 TS)	24.50	24.00	24.03	24.16	20.24	19.74	19.77	19.90
EGPRS(8PSK, 4 TS)	24.00	23.52	23.58	23.67	20.99	20.51	20.57	20.66

Note: The frame-averaged power is linearly scaled the maximum burst averaged power over 8 time slots. The calculated method are shown as below:

Frame-averaged power = Maximum burst averaged power (1 Tx Slot) - 9.03 dB

Frame-averaged power = Maximum burst averaged power (2 Tx Slots) - 6.02 dB

Frame-averaged power = Maximum burst averaged power (3 Tx Slots) - 4.26 dB

Frame-averaged power = Maximum burst averaged power (4 Tx Slots) - 3.01 dB

7.2. WCDMA Conducted Power

WCDMA Band1		Burst-Averaged output Power (dBm)			
Tx Channel	Tune-up (dBm)	9612	9750	9888	
Frequency (MHz)		1922.4	1950	1977.6	
RMC12.2K	24.00	23.26	23.50	23.43	
HSDPA Sub 1	23.50	23.34	23.13	23.44	
HSDPA Sub 2	23.50	22.98	22.87	23.19	
HSDPA Sub 3	23.00	22.67	22.64	22.77	
HSDPA Sub 4	23.00	22.31	22.39	22.67	
HSUPA Sub 1	23.50	23.16	22.93	23.17	
HSUPA Sub 2	23.50	23.19	23.12	23.37	
HSUPA Sub 3	23.50	22.85	23.04	23.03	
HSUPA Sub 4	23.50	23.25	23.12	23.33	
HSUPA Sub 5	23.50	22.81	22.95	23.25	
WCDMA Band 8		Burst-Averaged output Power (dBm)			
Tx Channel	Tune-up (dBm)	2712	2788	2863	
Frequency (MHz)		882.4	897.6	912.6	
RMC12.2K	23.50	23.26	22.97	23.05	
HSDPA Sub 1	23.00	22.97	22.87	22.52	
HSDPA Sub 2	23.00	22.72	22.52	22.26	
HSDPA Sub 3	22.50	22.17	22.23	21.91	
HSDPA Sub 4	22.50	22.05	21.73	21.38	
HSUPA Sub 1	23.00	22.76	22.69	22.32	
HSUPA Sub 2	23.00	22.80	22.75	22.46	
HSUPA Sub 3	22.50	22.42	22.49	22.32	
HSUPA Sub 4	23.00	22.77	22.84	22.41	
HSUPA Sub 5	23.00	22.53	22.56	22.17	

7.3. LTE Conducted Power

Band	Bandwidth (MHz)	UL Channel	RB Size	RB Position	Modulation	Tune-up	Power (dBm)
Band1	5	18025	1	#0	QPSK	24.50	23.98
Band1	5	18025	8	#0	QPSK	24.50	24.24
Band1	5	18025	25	#0	QPSK	24.50	23.06
Band1	5	18025	1	#0	QAM16	24.50	23.46
Band1	5	18025	8	#0	QAM16	24.50	23.54

Band1	5	18025	25	#0	QAM16	24.50	22.22
Band1	5	18300	1	#0	QPSK	24.50	24.03
Band1	5	18300	8	#0	QPSK	24.50	24.13
Band1	5	18300	25	#0	QPSK	24.50	23.13
Band1	5	18300	1	#0	QAM16	24.50	23.17
Band1	5	18300	8	#0	QAM16	24.50	23.44
Band1	5	18300	25	#0	QAM16	24.50	22.56
Band1	5	18575	1	#0	QPSK	24.50	23.89
Band1	5	18575	8	#0	QPSK	24.50	24.09
Band1	5	18575	25	#0	QPSK	24.50	23.10
Band1	5	18575	1	#0	QAM16	24.50	23.28
Band1	5	18575	8	#0	QAM16	24.50	23.36
Band1	5	18575	25	#0	QAM16	24.50	22.19
Band1	20	18100	1	#0	QPSK	24.50	23.62
Band1	20	18100	18	#0	QPSK	24.50	24.23
Band1	20	18100	100	#0	QPSK	24.50	23.09
Band1	20	18100	1	#0	QAM16	24.50	23.61
Band1	20	18100	18	#0	QAM16	24.50	23.30
Band1	20	18100	100	#0	QAM16	24.50	22.37
Band1	20	18300	1	#0	QPSK	24.50	23.66
Band1	20	18300	18	#0	QPSK	24.50	24.25
Band1	20	18300	100	#0	QPSK	24.50	23.21
Band1	20	18300	1	#0	QAM16	24.50	23.55
Band1	20	18300	18	#0	QAM16	24.50	23.42
Band1	20	18300	100	#0	QAM16	24.50	22.28
Band1	20	18500	1	#0	QPSK	24.50	23.83
Band1	20	18500	18	#0	QPSK	24.50	24.28
Band1	20	18500	100	#0	QPSK	24.50	23.06
Band1	20	18500	1	#0	QAM16	24.50	23.16
Band1	20	18500	18	#0	QAM16	24.50	23.44
Band1	20	18500	100	#0	QAM16	24.50	22.38
Band20	5	24175	1	#0	QPSK	24.00	23.42
Band20	5	24175	8	#0	QPSK	24.00	23.57
Band20	5	24175	25	#0	QPSK	24.00	22.69
Band20	5	24175	1	#0	QAM16	24.00	23.22
Band20	5	24175	8	#0	QAM16	24.00	22.76
Band20	5	24175	25	#0	QAM16	24.00	21.60
Band20	5	24300	1	#0	QPSK	24.00	23.99
Band20	5	24300	8	#0	QPSK	24.00	23.65
Band20	5	24300	25	#0	QPSK	24.00	22.58

Band20	5	24300	1	#0	QAM16	24.00	23.19
Band20	5	24300	8	#0	QAM16	24.00	22.88
Band20	5	24300	25	#0	QAM16	24.00	21.68
Band20	5	24425	1	#0	QPSK	24.00	23.77
Band20	5	24425	8	#0	QPSK	24.00	23.60
Band20	5	24425	25	#0	QPSK	24.00	22.35
Band20	5	24425	1	#0	QAM16	24.00	22.75
Band20	5	24425	8	#0	QAM16	24.00	22.73
Band20	5	24425	25	#0	QAM16	24.00	21.66
Band20	20	24250	1	#0	QPSK	24.00	23.86
Band20	20	24250	18	#0	QPSK	24.00	23.63
Band20	20	24250	100	#0	QPSK	24.00	22.71
Band20	20	24250	1	#0	QAM16	24.00	22.87
Band20	20	24250	18	#0	QAM16	24.00	22.81
Band20	20	24250	100	#0	QAM16	24.00	21.73
Band20	20	24300	1	#0	QPSK	24.00	23.71
Band20	20	24300	18	#0	QPSK	24.00	23.57
Band20	20	24300	100	#0	QPSK	24.00	22.71
Band20	20	24300	1	#0	QAM16	24.00	22.75
Band20	20	24300	18	#0	QAM16	24.00	22.76
Band20	20	24300	100	#0	QAM16	24.00	21.66
Band20	20	24350	1	#0	QPSK	24.00	23.77
Band20	20	24350	18	#0	QPSK	24.00	23.73
Band20	20	24350	100	#0	QPSK	24.00	22.53
Band20	20	24350	1	#0	QAM16	24.00	22.97
Band20	20	24350	18	#0	QAM16	24.00	22.74
Band20	20	24350	100	#0	QAM16	24.00	21.61
Band3	1.4	19207	1	#0	QPSK	24.50	23.82
Band3	1.4	19207	5	#0	QPSK	24.50	23.94
Band3	1.4	19207	6	#0	QPSK	24.50	22.95
Band3	1.4	19207	1	#0	QAM16	24.50	23.54
Band3	1.4	19207	5	#0	QAM16	24.50	23.06
Band3	1.4	19207	6	#0	QAM16	24.50	21.84
Band3	1.4	19575	1	#0	QPSK	24.50	23.85
Band3	1.4	19575	5	#0	QPSK	24.50	23.81
Band3	1.4	19575	6	#0	QPSK	24.50	22.68
Band3	1.4	19575	1	#0	QAM16	24.50	23.00
Band3	1.4	19575	5	#0	QAM16	24.50	22.63
Band3	1.4	19575	6	#0	QAM16	24.50	21.63
Band3	1.4	19943	1	#0	QPSK	24.50	24.35

Band3	1.4	19943	5	#0	QPSK	24.50	24.01
Band3	1.4	19943	6	#0	QPSK	24.50	23.10
Band3	1.4	19943	1	#0	QAM16	24.50	23.49
Band3	1.4	19943	5	#0	QAM16	24.50	23.15
Band3	1.4	19943	6	#0	QAM16	24.50	22.04
Band3	5	19225	1	#0	QPSK	24.50	24.36
Band3	5	19225	8	#0	QPSK	24.50	23.95
Band3	5	19225	25	#0	QPSK	24.50	22.96
Band3	5	19225	1	#0	QAM16	24.50	23.50
Band3	5	19225	8	#0	QAM16	24.50	23.32
Band3	5	19225	25	#0	QAM16	24.50	22.34
Band3	5	19575	1	#0	QPSK	24.50	23.96
Band3	5	19575	8	#0	QPSK	24.50	23.79
Band3	5	19575	25	#0	QPSK	24.50	22.75
Band3	5	19575	1	#0	QAM16	24.50	23.08
Band3	5	19575	8	#0	QAM16	24.50	23.01
Band3	5	19575	25	#0	QAM16	24.50	22.13
Band3	5	19925	1	#0	QPSK	24.50	24.36
Band3	5	19925	8	#0	QPSK	24.50	24.10
Band3	5	19925	25	#0	QPSK	24.50	23.10
Band3	5	19925	1	#0	QAM16	24.50	23.50
Band3	5	19925	8	#0	QAM16	24.50	23.27
Band3	5	19925	25	#0	QAM16	24.50	22.11
Band3	20	19300	1	#0	QPSK	24.50	23.97
Band3	20	19300	18	#0	QPSK	24.50	23.98
Band3	20	19300	100	#0	QPSK	24.50	22.99
Band3	20	19300	1	#0	QAM16	24.50	23.60
Band3	20	19300	18	#0	QAM16	24.50	23.14
Band3	20	19300	100	#0	QAM16	24.50	22.12
Band3	20	19575	1	#0	QPSK	24.50	23.92
Band3	20	19575	18	#0	QPSK	24.50	23.70
Band3	20	19575	100	#0	QPSK	24.50	22.75
Band3	20	19575	1	#0	QAM16	24.50	23.10
Band3	20	19575	18	#0	QAM16	24.50	23.00
Band3	20	19575	100	#0	QAM16	24.50	21.88
Band3	20	19850	1	#0	QPSK	24.50	24.14
Band3	20	19850	18	#0	QPSK	24.50	23.95
Band3	20	19850	100	#0	QPSK	24.50	22.94
Band3	20	19850	1	#0	QAM16	24.50	23.30
Band3	20	19850	18	#0	QAM16	24.50	23.10

Band3	20	19850	100	#0	QAM16	24.50	22.14
Band40	5	38675	1	#0	QPSK	24.50	23.61
Band40	5	38675	8	#0	QPSK	24.50	24.11
Band40	5	38675	25	#0	QPSK	24.50	23.18
Band40	5	38675	1	#0	QAM16	24.50	22.41
Band40	5	38675	8	#0	QAM16	24.50	23.34
Band40	5	38675	25	#0	QAM16	24.50	22.35
Band40	5	39150	1	#0	QPSK	24.50	23.50
Band40	5	39150	8	#0	QPSK	24.50	23.92
Band40	5	39150	25	#0	QPSK	24.50	22.89
Band40	5	39150	1	#0	QAM16	24.50	22.21
Band40	5	39150	8	#0	QAM16	24.50	23.26
Band40	5	39150	25	#0	QAM16	24.50	22.18
Band40	5	39625	1	#0	QPSK	24.50	24.11
Band40	5	39625	8	#0	QPSK	24.50	24.27
Band40	5	39625	25	#0	QPSK	24.50	23.32
Band40	5	39625	1	#0	QAM16	24.50	22.71
Band40	5	39625	8	#0	QAM16	24.50	23.64
Band40	5	39625	25	#0	QAM16	24.50	22.61
Band40	20	38750	1	#0	QPSK	24.50	24.11
Band40	20	38750	18	#0	QPSK	24.50	24.23
Band40	20	38750	100	#0	QPSK	24.50	22.95
Band40	20	38750	1	#0	QAM16	24.50	22.41
Band40	20	38750	18	#0	QAM16	24.50	23.51
Band40	20	38750	100	#0	QAM16	24.50	22.18
Band40	20	39150	1	#0	QPSK	24.50	23.94
Band40	20	39150	18	#0	QPSK	24.50	24.11
Band40	20	39150	100	#0	QPSK	24.50	22.93
Band40	20	39150	1	#0	QAM16	24.50	22.20
Band40	20	39150	18	#0	QAM16	24.50	23.31
Band40	20	39150	100	#0	QAM16	24.50	22.19
Band40	20	39550	1	#0	QPSK	24.50	24.02
Band40	20	39550	18	#0	QPSK	24.50	24.31
Band40	20	39550	100	#0	QPSK	24.50	23.27
Band40	20	39550	1	#0	QAM16	24.50	22.63
Band40	20	39550	18	#0	QAM16	24.50	23.48
Band40	20	39550	100	#0	QAM16	24.50	22.38
Band7	5	20775	1	#0	QPSK	25.00	24.11
Band7	5	20775	8	#0	QPSK	25.00	24.37
Band7	5	20775	25	#0	QPSK	25.00	23.41

Band7	5	20775	1	#0	QAM16	25.00	23.25
Band7	5	20775	8	#0	QAM16	25.00	23.60
Band7	5	20775	25	#0	QAM16	25.00	22.68
Band7	5	21100	1	#0	QPSK	25.00	24.28
Band7	5	21100	8	#0	QPSK	25.00	24.52
Band7	5	21100	25	#0	QPSK	25.00	23.51
Band7	5	21100	1	#0	QAM16	25.00	23.44
Band7	5	21100	8	#0	QAM16	25.00	23.73
Band7	5	21100	25	#0	QAM16	25.00	22.84
Band7	5	21425	1	#0	QPSK	25.00	24.20
Band7	5	21425	8	#0	QPSK	25.00	24.37
Band7	5	21425	25	#0	QPSK	25.00	23.40
Band7	5	21425	1	#0	QAM16	25.00	23.28
Band7	5	21425	8	#0	QAM16	25.00	23.78
Band7	5	21425	25	#0	QAM16	25.00	22.71
Band7	20	20850	1	#0	QPSK	25.00	24.00
Band7	20	20850	18	#0	QPSK	25.00	24.42
Band7	20	20850	100	#0	QPSK	25.00	23.25
Band7	20	20850	1	#0	QAM16	25.00	23.18
Band7	20	20850	18	#0	QAM16	25.00	23.64
Band7	20	20850	100	#0	QAM16	25.00	22.51
Band7	20	21100	1	#0	QPSK	25.00	24.25
Band7	20	21100	18	#0	QPSK	25.00	24.51
Band7	20	21100	100	#0	QPSK	25.00	23.52
Band7	20	21100	1	#0	QAM16	25.00	23.48
Band7	20	21100	18	#0	QAM16	25.00	23.67
Band7	20	21100	100	#0	QAM16	25.00	22.62
Band7	20	21350	1	#0	QPSK	25.00	24.18
Band7	20	21350	18	#0	QPSK	25.00	24.58
Band7	20	21350	100	#0	QPSK	25.00	23.35
Band7	20	21350	1	#0	QAM16	25.00	23.42
Band7	20	21350	18	#0	QAM16	25.00	23.76
Band7	20	21350	100	#0	QAM16	25.00	22.65
Band8	1.4	21457	1	#0	QPSK	24.50	24.07
Band8	1.4	21457	5	#0	QPSK	24.50	23.89
Band8	1.4	21457	6	#0	QPSK	24.50	22.43
Band8	1.4	21457	1	#0	QAM16	24.50	22.86
Band8	1.4	21457	5	#0	QAM16	24.50	22.81
Band8	1.4	21457	6	#0	QAM16	24.50	21.24
Band8	1.4	21625	1	#0	QPSK	24.50	24.25

Band8	1.4	21625	5	#0	QPSK	24.50	23.98
Band8	1.4	21625	6	#0	QPSK	24.50	22.45
Band8	1.4	21625	1	#0	QAM16	24.50	22.91
Band8	1.4	21625	5	#0	QAM16	24.50	22.82
Band8	1.4	21625	6	#0	QAM16	24.50	21.25
Band8	1.4	21793	1	#0	QPSK	24.50	24.00
Band8	1.4	21793	5	#0	QPSK	24.50	24.00
Band8	1.4	21793	6	#0	QPSK	24.50	22.37
Band8	1.4	21793	1	#0	QAM16	24.50	22.85
Band8	1.4	21793	5	#0	QAM16	24.50	22.89
Band8	1.4	21793	6	#0	QAM16	24.50	21.20
Band8	5	21475	1	#0	QPSK	24.50	24.25
Band8	5	21475	8	#0	QPSK	24.50	23.97
Band8	5	21475	25	#0	QPSK	24.50	22.43
Band8	5	21475	1	#0	QAM16	24.50	23.07
Band8	5	21475	8	#0	QAM16	24.50	23.07
Band8	5	21475	25	#0	QAM16	24.50	21.71
Band8	5	21625	1	#0	QPSK	24.50	24.27
Band8	5	21625	8	#0	QPSK	24.50	23.98
Band8	5	21625	25	#0	QPSK	24.50	22.43
Band8	5	21625	1	#0	QAM16	24.50	22.97
Band8	5	21625	8	#0	QAM16	24.50	23.04
Band8	5	21625	25	#0	QAM16	24.50	21.71
Band8	5	21775	1	#0	QPSK	24.50	24.35
Band8	5	21775	8	#0	QPSK	24.50	24.16
Band8	5	21775	25	#0	QPSK	24.50	22.48
Band8	5	21775	1	#0	QAM16	24.50	23.18
Band8	5	21775	8	#0	QAM16	24.50	23.06
Band8	5	21775	25	#0	QAM16	24.50	21.76
Band8	10	21500	1	#0	QPSK	24.50	24.02
Band8	10	21500	12	#0	QPSK	24.50	23.87
Band8	10	21500	50	#0	QPSK	24.50	22.46
Band8	10	21500	1	#0	QAM16	24.50	23.52
Band8	10	21500	12	#0	QAM16	24.50	23.11
Band8	10	21500	50	#0	QAM16	24.50	21.52
Band8	10	21625	1	#0	QPSK	24.50	24.04
Band8	10	21625	12	#0	QPSK	24.50	23.95
Band8	10	21625	50	#0	QPSK	24.50	22.48
Band8	10	21625	1	#0	QAM16	24.50	23.51
Band8	10	21625	12	#0	QAM16	24.50	23.06

Band8	10	21625	50	#0	QAM16	24.50	21.57
Band8	10	21750	1	#0	QPSK	24.50	24.10
Band8	10	21750	12	#0	QPSK	24.50	24.19
Band8	10	21750	50	#0	QPSK	24.50	22.41
Band8	10	21750	1	#0	QAM16	24.50	23.57
Band8	10	21750	12	#0	QAM16	24.50	23.28
Band8	10	21750	50	#0	QAM16	24.50	21.63

7.4. WLAN & Bluetooth Output Power

Mode	Channel	Frequency (MHz)	Tune-up (dBm)	Output Power (dBm)
802.11b	1	2412	15.50	15.14
	7	2442	15.50	14.22
	13	2472	15.50	14.06
802.11g	1	2412	13.50	13.10
	7	2442	13.50	11.94
	13	2472	13.50	12.46
802.11n (HT20)	1	2412	13.00	12.14
	7	2442	13.00	12.90
	13	2472	13.00	12.47
802.11n (HT40)	3	2422	13.00	12.59
	7	2442	13.00	11.47
	11	2462	13.00	11.36

NOTE: Power measurement results of WLAN 2.4G.

Mode	Channel	Frequency (MHz)	Tune - up(dBm)	Output Power (dBm)
802.11a	36	5180	9.50	9.43
	40	5200	9.50	9.35
	48	5240	9.50	9.30
802.11n (HT20)	36	5180	9.50	9.42
	40	5200	9.50	9.37
	48	5240	9.50	9.31
802.11n (HT40)	38	5190	10.00	9.71
	46	5230	10.00	9.65
802.11ac (VHT20)	36	5180	10.00	9.63
	40	5200	10.00	9.58
	48	5240	10.00	9.50
802.11ac (VHT40)	38	5190	10.00	9.69
	46	5230	10.00	9.49

802.11ac (VHT80)	42	5210	10.00	9.80
---------------------	----	------	-------	------

NOTE: Power measurement results of WLAN 5.2G.

Mode	Channel	Frequency (MHz)	Tune-up(dBm)	Output Power (dBm)
802.11a	149	5745	9.00	8.43
	157	5785	9.00	8.68
	165	5825	9.00	7.67
802.11n HT20	149	5745	9.00	8.40
	157	5785	9.00	8.57
	165	5825	9.00	7.65
802.11n HT40	151	5755	9.00	8.89
	159	5795	9.00	8.64
802.11ac VHT20	149	5745	8.50	8.35
	157	5785	8.50	8.49
	165	5825	8.50	7.56
802.11ac VHT40	151	5755	8.50	8.08
	159	5795	8.50	7.87
802.11ac VHT80	155	5775	8.50	8.15

NOTE: Power measurement results of WLAN 5.8G.

BR+EDR	Data Rates	Tune - up(dBm)	Output Power (dBm)
	GFSK DH5	7.50	7.11
	Pi/4 DQPSK DH5	5.50	5.38
	8DPSK DH5	5.50	5.36

BLE	Channel	Tune - up(dBm)	Output Power (dBm)	
			1M	2M
	0CH	-6.00	-7.48	-6.67
	19CH	-6.00	-6.95	-8.31
39CH	-8.00	-8.46	-8.61	

NOTE: Power measurement results of Bluetooth. Refer to EN 62479, the available power of this EUT is 7.50Bm (5.62mW), the power is less than the low-power exclusion level defined in 4.2 (P max: 20mW), So Bluetooth stand-alone SAR is not required.

7.5. NFC Assessment

NFC	Frequency (MHz)	H-Field(dBuA/m)@3m	Output Power (dBm)	Output Power (mW)	Limits (mW)
	13.56MHz	41.3	0.57	1.14	20

NOTE: Refer to EN 62479, the available power of this EUT is 0.57dBm (1.14mW), the power is less than the low-power exclusion level defined in 4.2 (P max: 20mW), So the NFC is compliance.

8. Assessment of the compliance of low power equipment

According to EN 62479 Clause 4.1& 4.2, these require does not apply to the receivers that has no transmit. So the FM and GPS is compliance.

9. SAR Results

9.1. SAR measurement results

9.1.1. SAR measurement Result of GSM900

Test Position	Test channel /Freq.	Test Mode	Separation distance (mm)	SAR Value (W/kg)		Power Drift (±5%)	Conducted power (dBm)	Tune-up power (dBm)	Scaled SAR 10g (W/Kg)	Date
				1g	10g					
Head										
Left Cheek	38/897.6	GPRS(GMSK 4TS)	0	0.179	0.136	-1.87	29.60	30.00	0.149	2022/11/07
Left Tilt 15 Degree	38/897.6	GPRS(GMSK 4TS)	0	0.096	0.070	4.72	29.60	30.00	0.077	2022/11/07
Right Cheek	38/897.6	GPRS(GMSK 4TS)	0	0.167	0.123	-3.77	29.60	30.00	0.135	2022/11/07
Right Tilt 15 Degree	38/897.6	GPRS(GMSK 4TS)	0	0.084	0.064	-3.72	29.60	30.00	0.070	2022/11/07
Extremity										
Front Side	38/897.6	GPRS(GMSK 4TS)	0	1.893	0.777	3.29	29.60	30.00	0.852	2022/11/07
Back Side	38/897.6	GPRS(GMSK 4TS)	0	3.104	1.341	-1.44	29.60	30.00	1.470	2022/11/07
Left Side	38/897.6	GPRS(GMSK 4TS)	0	1.211	0.523	-1.46	29.60	30.00	0.573	2022/11/07
Right Side	38/897.6	GPRS(GMSK 4TS)	0	0.590	0.247	2.65	29.60	30.00	0.271	2022/11/07

Top Side	38/897.6	GPRS(GMSK 4TS)	0	0.466	0.195	-2.51	29.60	30.00	0.214	2022/11/07
Bottom Side	38/897.6	GPRS(GMSK 4TS)	0	1.738	0.713	-1.04	29.60	30.00	0.782	2022/11/07
Body & Hotspot with 5mm (Worst-case position for 0mm)										
Back Side	38/897.6	GPRS(GMSK 4TS)	5	1.707	0.723	0.60	29.60	30.00	0.793	2022/11/07

9.1.2. SAR measurement Result of GSM1800

Test Position	Test channel /Freq.	Test Mode	Separation distance (mm)	SAR Value (W/kg)		Power Drift (±5%)	Conducted power (dBm)	Tune-up power (dBm)	Scaled SAR 10g (W/Kg)	Date
				1g	10g					
Head										
Left Cheek	698/1747.4	GPRS(GMSK 4TS)	0	0.155	0.098	-4.94	26.37	27.00	0.113	2022/10/28
Left Tilt 15 Degree	698/1747.4	GPRS(GMSK 4TS)	0	0.080	0.049	-1.54	26.37	27.00	0.057	2022/10/28
Right Cheek	698/1747.4	GPRS(GMSK 4TS)	0	0.137	0.086	0.90	26.37	27.00	0.099	2022/10/28
Right Tilt 15 Degree	698/1747.4	GPRS(GMSK 4TS)	0	0.072	0.046	4.41	26.37	27.00	0.053	2022/10/28
Extremity										
Front Side	698/1747.4	GPRS(GMSK 4TS)	0	2.500	1.043	-1.69	26.37	27.00	1.206	2022/10/28
Back Side	698/1747.4	GPRS(GMSK 4TS)	0	3.846	1.637	-0.19	26.37	27.00	1.893	2022/10/28
Left Side	698/1747.4	GPRS(GMSK 4TS)	0	1.423	0.606	-1.61	26.37	27.00	0.701	2022/10/28
Right Side	698/1747.4	GPRS(GMSK 4TS)	0	0.615	0.249	1.18	26.37	27.00	0.288	2022/10/28
Top Side	698/1747.4	GPRS(GMSK 4TS)	0	0.500	0.206	-0.26	26.37	27.00	0.238	2022/10/28
Bottom Side	698/1747.4	GPRS(GMSK 4TS)	0	2.308	0.953	-2.32	26.37	27.00	1.102	2022/10/28
Back Side										
Back	698/1747.4	GPRS(GMSK 4TS)	5	0.680	0.338	0.27	26.37	27.00	0.391	2022/10/28

										(W/Kg)
Head										
Left Cheek	2788/897.6	RMC12.2K	0	0.148	0.114	1.58	22.97	23.50	0.129	2022/11/07
Left Tilt 15 Degree	2788/897.6	RMC12.2K	0	0.087	0.064	-1.77	22.97	23.50	0.072	2022/11/07
Right Cheek	2788/897.6	RMC12.2K	0	0.135	0.102	-1.94	22.97	23.50	0.115	2022/11/07
Right Tilt 15 Degree	2788/897.6	RMC12.2K	0	0.070	0.053	1.36	22.97	23.50	0.060	2022/11/07
Extremity										
Front Side	2788/897.6	RMC12.2K	0	1.303	0.550	3.40	22.97	23.50	0.621	2022/11/07
Back Side	2788/897.6	RMC12.2K	0	2.171	0.965	0.25	22.97	23.50	1.090	2022/11/07
Left Side	2788/897.6	RMC12.2K	0	0.825	0.352	-1.95	22.97	23.50	0.398	2022/11/07
Right Side	2788/897.6	RMC12.2K	0	0.347	0.148	-0.03	22.97	23.50	0.167	2022/11/07
Top Side	2788/897.6	RMC12.2K	0	0.304	0.135	-2.00	22.97	23.50	0.153	2022/11/07
Bottom Side	2788/897.6	RMC12.2K	0	1.259	0.532	1.38	22.97	23.50	0.601	2022/11/07
Body & Hotspot with 5mm (Worst-case position for 0mm)										
Back Side	2788/897.6	RMC12.2K	5	1.389	0.587	-0.62	22.97	23.50	0.663	2022/11/07

9.1.5. SAR measurement Result of LTE Band 1

Test Position	Test channel /Freq.	Test Mode	Separation distance (mm)	SAR Value (W/kg)		Power Drift (±5%)	Conducted power (dBm)	Tune-up power (dBm)	Scaled SAR 10g (W/Kg)	Date
				1g	10g					
Head										
Left Cheek	18300/1950	20M QPSK(1,0)	0	0.351	0.159	1.77	23.66	24.50	0.193	2022/11/08
Left Tilt 15 Degree	18300/1950	20M QPSK(1,0)	0	0.203	0.090	1.92	23.66	24.50	0.109	2022/11/08

Right Cheek	18300/1950	20M QPSK(1,0)	0	0.306	0.139	1.64	23.66	24.50	0.169	2022/11/08
Right Tilt 15 Degree	18300/1950	20M QPSK(1,0)	0	0.156	0.070	4.61	23.66	24.50	0.085	2022/11/08
Extremity										
Front Side	18300/1950	20M QPSK(1,0)	0	0.802	0.349	3.54	23.66	24.50	0.423	2022/11/08
Back Side	18300/1950	20M QPSK(1,0)	0	1.294	0.592	4.68	23.66	24.50	0.718	2022/11/08
Left Side	18300/1950	20M QPSK(1,0)	0	0.466	0.207	3.22	23.66	24.50	0.251	2022/11/08
Right Side	18300/1950	20M QPSK(1,0)	0	0.259	0.115	-0.55	23.66	24.50	0.140	2022/11/08
Top Side	18300/1950	20M QPSK(1,0)	0	0.168	0.076	0.62	23.66	24.50	0.092	2022/11/08
Bottom Side	18300/1950	20M QPSK(1,0)	0	0.776	0.341	-1.31	23.66	24.50	0.414	2022/11/08
Body & Hotspot with 5mm (Worst-case position for 0mm)										
Back Side	18300/1950	20M QPSK(1,0)	5	0.789	0.350	0.09	23.66	24.50	0.425	2022/11/08

9.1.6. SAR measurement Result of LTE Band 3

Test Position	Test channel /Freq.	Test Mode	Separation distance (mm)	SAR Value (W/kg)		Power Drift (±5%)	Conducted power (dBm)	Tune-up power (dBm)	Scaled SAR 10g (W/Kg)	Date
				1g	10g					
Head										
Left Cheek	19575/1747.5	20M QPSK(1,0)	0	0.516	0.114	-4.80	23.92	24.50	0.130	2022/10/28
Left Tilt 15 Degree	19575/1747.5	20M QPSK(1,0)	0	0.265	0.059	3.80	23.92	24.50	0.067	2022/10/28
Right Cheek	19575/1747.5	20M QPSK(1,0)	0	0.477	0.100	0.18	23.92	24.50	0.114	2022/10/28
Right Tilt 15 Degree	19575/1747.5	20M QPSK(1,0)	0	0.222	0.047	-3.02	23.92	24.50	0.054	2022/10/28
Extremity										

Front Side	19575/1747.5	20M QPSK(1,0)	0	3.996	1.411	3.74	23.92	24.50	1.613	2022/10/28
Back Side	19575/1747.5	20M QPSK(1,0)	0	6.243	2.297	2.71	23.92	24.50	2.625	2022/10/28
Left Side	19575/1747.5	20M QPSK(1,0)	0	2.435	0.860	-1.32	23.92	24.50	0.983	2022/10/28
Right Side	19575/1747.5	20M QPSK(1,0)	0	0.999	0.357	-0.08	23.92	24.50	0.408	2022/10/28
Top Side	19575/1747.5	20M QPSK(1,0)	0	0.749	0.267	1.74	23.92	24.50	0.305	2022/10/28
Bottom Side	19575/1747.5	20M QPSK(1,0)	0	3.683	1.287	-1.70	23.92	24.50	1.471	2022/10/28
Back Side	19300/1720	20M QPSK(1,0)	0	7.401	2.670	-1.23	23.97	24.50	3.017	2022/10/28
Back Side	19850/1775	20M QPSK(1,0)	0	5.595	2.160	-0.52	24.14	24.50	2.347	2022/10/28
Body & Hotspot with 5mm (Worst-case position for 0mm)										
Back Side	19300/1720	20M QPSK(1,0)	5	1.528	0.744	-0.55	23.97	24.50	0.841	2022/10/28

9.1.7. SAR measurement Result of LTE Band 7

Test Position	Test channel /Freq.	Test Mode	Separation distance (mm)	SAR Value (W/kg)		Power Drift (±5%)	Conducted power (dBm)	Tune-up power (dBm)	Scaled SAR 10g (W/Kg)	Date
				1g	10g					
Head										
Left Cheek	21100/2535	20M QPSK(1,0)	0	0.472	0.221	-2.42	24.25	25.00	0.263	2022/11/10
Left Tilt 15 Degree	21100/2535	20M QPSK(1,0)	0	0.246	0.112	0.84	24.25	25.00	0.133	2022/11/10
Right Cheek	21100/2535	20M QPSK(1,0)	0	0.444	0.200	-1.14	24.25	25.00	0.238	2022/11/10
Right Tilt 15 Degree	21100/2535	20M QPSK(1,0)	0	0.240	0.110	3.58	24.25	25.00	0.131	2022/11/10
Extremity										
Front Side	21100/2535	20M QPSK(1,0)	0	0.683	0.102	1.49	24.25	25.00	0.121	2022/11/10
Back	21100/2535	20M	0	1.138	0.174	1.25	24.25	25.00	0.207	2022/11/10

Side		QPSK(1,0)								
Left Side	21100/2535	20M QPSK(1,0)	0	0.444	0.064	-2.53	24.25	25.00	0.076	2022/11/10
Right Side	21100/2535	20M QPSK(1,0)	0	0.216	0.032	-1.70	24.25	25.00	0.038	2022/11/10
Top Side	21100/2535	20M QPSK(1,0)	0	0.137	0.021	-1.05	24.25	25.00	0.025	2022/11/10
Bottom Side	21100/2535	20M QPSK(1,0)	0	0.671	0.097	-0.16	24.25	25.00	0.115	2022/11/10
Body & Hotspot with 5mm (Worst-case position for 0mm)										
Back Side	21100/2535	20M QPSK(1,0)	5	0.717	0.106	3.99	24.25	25.00	0.126	2022/11/10

9.1.8. SAR measurement Result of LTE Band 8

Test Position	Test channel /Freq.	Test Mode	Separation distance (mm)	SAR Value (W/kg)		Power Drift (±5%)	Conducted power (dBm)	Tune-up power (dBm)	Scaled SAR 10g (W/Kg)	Date
				1g	10g					
Head										
Left Cheek	21625/897.5	10M QPSK(1,0)	0	0.089	0.052	-4.17	24.04	24.50	0.058	2022/11/07
Left Tilt 15 Degree	21625/897.5	10M QPSK(1,0)	0	0.047	0.027	4.35	24.04	24.50	0.030	2022/11/07
Right Cheek	21625/897.5	10M QPSK(1,0)	0	0.079	0.045	3.68	24.04	24.50	0.050	2022/11/07
Right Tilt 15 Degree	21625/897.5	10M QPSK(1,0)	0	0.039	0.022	-1.02	24.04	24.50	0.024	2022/11/07
Extremity										
Front Side	21625/897.5	10M QPSK(1,0)	0	0.500	0.110	3.07	24.04	24.50	0.122	2022/11/07
Back Side	21625/897.5	10M QPSK(1,0)	0	0.833	0.191	3.74	24.04	24.50	0.212	2022/11/07
Left Side	21625/897.5	10M QPSK(1,0)	0	0.308	0.069	0.16	24.04	24.50	0.077	2022/11/07
Right Side	21625/897.5	10M QPSK(1,0)	0	0.133	0.029	-2.51	24.04	24.50	0.032	2022/11/07
Top Side	21625/897.5	10M QPSK(1,0)	0	0.108	0.024	-1.27	24.04	24.50	0.027	2022/11/07

Bottom Side	21625/897.5	10M QPSK(1,0)	0	0.491	0.109	-0.83	24.04	24.50	0.121	2022/11/07
Body & Hotspot with 5mm (Worst-case position for 0mm)										
Back Side	21625/897.5	10M QPSK(1,0)	5	0.541	0.118	-0.08	24.04	24.50	0.131	2022/11/07

9.1.9. SAR measurement Result of LTE Band 20

Test Position	Test channel /Freq.	Test Mode	Separation distance (mm)	SAR Value (W/kg)		Power Drift (±5%)	Conducted power (dBm)	Tune-up power (dBm)	Scaled SAR 10g (W/Kg)	Date
				1g	10g					
Head										
Left Cheek	24300/847	20M QPSK(1,0)	0	0.181	0.139	0.10	23.71	24.00	0.149	2022/11/07
Left Tilt 15 Degree	24300/847	20M QPSK(1,0)	0	0.108	0.083	-2.01	23.71	24.00	0.089	2022/11/07
Right Cheek	24300/847	20M QPSK(1,0)	0	0.163	0.123	-3.69	23.71	24.00	0.131	2022/11/07
Right Tilt 15 Degree	24300/847	20M QPSK(1,0)	0	0.080	0.061	1.10	23.71	24.00	0.065	2022/11/07
Extremity										
Front Side	24300/847	20M QPSK(1,0)	0	1.454	0.630	-0.41	23.71	24.00	0.674	2022/11/07
Back Side	24300/847	20M QPSK(1,0)	0	2.424	1.051	-2.76	23.71	24.00	1.124	2022/11/07
Left Side	24300/847	20M QPSK(1,0)	0	0.970	0.412	-2.24	23.71	24.00	0.440	2022/11/07
Right Side	24300/847	20M QPSK(1,0)	0	0.412	0.170	-1.56	23.71	24.00	0.182	2022/11/07
Top Side	24300/847	20M QPSK(1,0)	0	0.364	0.156	-2.38	23.71	24.00	0.167	2022/11/07
Bottom Side	24300/847	20M QPSK(1,0)	0	1.454	0.605	2.81	23.71	24.00	0.647	2022/11/07
Body & Hotspot with 5mm (Worst-case position for 0mm)										
Back Side	24300/847	20M QPSK(1,0)	5	1.454	0.624	-1.43	23.71	24.00	0.667	2022/11/07

9.1.10. SAR measurement Result of LTE Band 40

Test Position	Test channel /Freq.	Test Mode	Separation distance (mm)	SAR Value (W/kg)		Power Drift (±5%)	Conducted power (dBm)	Tune-up power (dBm)	Scaled SAR 10g (W/Kg)	Date
				1g	10g					
Head										
Left Cheek	39150/2350	20M QPSK(1,0)	0	0.320	0.192	-3.45	23.94	24.50	0.218	2022/11/09
Left Tilt 15 Degree	39150/2350	20M QPSK(1,0)	0	0.192	0.113	5.43	23.94	24.50	0.129	2022/11/09
Right Cheek	39150/2350	20M QPSK(1,0)	0	0.287	0.165	1.10	23.94	24.50	0.188	2022/11/09
Right Tilt 15 Degree	39150/2350	20M QPSK(1,0)	0	0.158	0.090	-1.54	23.94	24.50	0.102	2022/11/09
Extremity										
Front Side	39150/2350	20M QPSK(1,0)	0	1.339	0.504	-0.90	23.94	24.50	0.573	2022/11/09
Back Side	39150/2350	20M QPSK(1,0)	0	2.195	0.834	0.76	23.94	24.50	0.949	2022/11/09
Left Side	39150/2350	20M QPSK(1,0)	0	0.834	0.317	-0.99	23.94	24.50	0.361	2022/11/09
Right Side	39150/2350	20M QPSK(1,0)	0	0.329	0.120	2.00	23.94	24.50	0.137	2022/11/09
Top Side	39150/2350	20M QPSK(1,0)	0	0.220	0.080	-1.41	23.94	24.50	0.091	2022/11/09
Bottom Side	39150/2350	20M QPSK(1,0)	0	1.273	0.469	3.51	23.94	24.50	0.534	2022/11/09
Body & Hotspot with 5mm (Worst-case position for 0mm)										
Back Side	39150/2350	20M QPSK(1,0)	5	1.427	0.537	0.69	23.94	24.50	0.611	2022/11/09

9.1.11. SAR measurement Result of WLAN 2.4G

Test Position	Test channel /Freq.	Test Mode	Separation distance (mm)	SAR Value (W/kg)		Power Drift (±5%)	Conducted power (dBm)	Tune-up power (dBm)	Scaled SAR 10g (W/Kg)	Date
				1g	10g					
Head										

Left Cheek	7/2442	802.11 b	0	0.515	0.257	-2.60	14.22	15.50	0.345	2022/11/01
Left Tilt 15 Degree	7/2442	802.11 b	0	0.297	0.144	-1.90	14.22	15.50	0.193	2022/11/01
Right Cheek	7/2442	802.11 b	0	0.458	0.219	1.19	14.22	15.50	0.294	2022/11/01
Right Tilt 15 Degree	7/2442	802.11 b	0	0.226	0.111	-2.67	14.22	15.50	0.149	2022/11/01
Extremity										
Front Side	7/2442	802.11 b	0	0.774	0.325	3.18	14.22	15.50	0.436	2022/11/01
Back Side	7/2442	802.11 b	0	1.210	0.529	-0.44	14.22	15.50	0.710	2022/11/01
Left Side	7/2442	802.11 b	0	0.218	0.091	2.43	14.22	15.50	0.122	2022/11/01
Right Side	7/2442	802.11 b	0	0.484	0.203	-1.38	14.22	15.50	0.273	2022/11/01
Top Side	7/2442	802.11 b	0	0.545	0.231	-3.38	14.22	15.50	0.310	2022/11/01
Bottom Side	7/2442	802.11 b	0	0.145	0.060	1.36	14.22	15.50	0.081	2022/11/01
Body & Hotspot with 5mm (Worst-case position for 0mm)										
Back Side	7/2442	802.11 b	5	0.605	0.262	-0.11	14.22	15.50	0.352	2022/11/01

9.1.12. SAR measurement Result of WLAN 5.2G

Test Position	Test channel /Freq.	Test Mode	Separation distance (mm)	SAR Value (W/kg)		Power Drift (±5%)	Conducted power (dBm)	Tune-up power (dBm)	Scaled SAR 10g (W/Kg)	Date
				1g	10g					
Head										
Left Cheek	38/5190	802.11n HT40	0	3.242	0.902	0.30	9.71	10.00	0.964	2022/11/04
Left Tilt 15 Degree	38/5190	802.11n HT40	0	1.830	0.479	5.66	9.71	10.00	0.512	2022/11/04
Right Cheek	38/5190	802.11n HT40	0	3.105	0.821	4.87	9.71	10.00	0.878	2022/11/04

Right Tilt 15 Degree	38/5190	802.11n HT40	0	1.531	0.409	1.04	9.71	10.00	0.437	2022/11/04
Extremity										
Front Side	38/5190	802.11n HT40	0	1.595	0.454	-3.38	9.71	10.00	0.485	2022/11/04
Back Side	38/5190	802.11n HT40	0	2.572	0.755	-0.49	9.71	10.00	0.807	2022/11/04
Left Side	38/5190	802.11n HT40	0	0.437	0.122	-1.62	9.71	10.00	0.130	2022/11/04
Right Side	38/5190	802.11n HT40	0	1.029	0.302	-1.97	9.71	10.00	0.323	2022/11/04
Top Side	38/5190	802.11n HT40	0	1.260	0.362	1.67	9.71	10.00	0.387	2022/11/04
Bottom Side	38/5190	802.11n HT40	0	0.334	0.096	0.19	9.71	10.00	0.103	2022/11/04
Body & Hotspot with 5mm (Worst-case position for 0mm)										
Back Side	38/5190	802.11n HT40	5	1.312	0.366	-2.15	9.71	10.00	0.391	2022/11/04

9.1.13. SAR measurement Result of WLAN 5.8G

Test Position	Test channel /Freq.	Test Mode	Separation distance (mm)	SAR Value (W/kg)		Power Drift (±5%)	Conducted power (dBm)	Tune-up power (dBm)	Scaled SAR 10g (W/Kg)	Date
				1g	10g					
Head										
Left Cheek	157/5785	802.11 a	0	1.245	0.372	-2.14	8.68	9.00	0.400	2022/11/05
Left Tilt 15 Degree	157/5785	802.11 a	0	0.684	0.202	0.21	8.68	9.00	0.217	2022/11/05
Right Cheek	157/5785	802.11 a	0	1.151	0.330	-4.04	8.68	9.00	0.355	2022/11/05
Right Tilt 15 Degree	157/5785	802.11 a	0	0.587	0.170	4.80	8.68	9.00	0.183	2022/11/05
Extremity										
Front Side	157/5785	802.11 a	0	0.725	0.231	3.98	8.68	9.00	0.249	2022/11/05
Back Side	157/5785	802.11 a	0	1.190	0.387	0.94	8.68	9.00	0.417	2022/11/05

Left Side	157/5785	802.11 a	0	0.226	0.073	2.46	8.68	9.00	0.079	2022/11/05
Right Side	157/5785	802.11 a	0	0.523	0.162	-0.54	8.68	9.00	0.174	2022/11/05
Top Side	157/5785	802.11 a	0	0.583	0.188	-3.13	8.68	9.00	0.202	2022/11/05
Bottom Side	157/5785	802.11 a	0	0.143	0.045	0.12	8.68	9.00	0.048	2022/11/05
Body & Hotspot with 5mm (Worst-case position for 0mm)										
Back Side	157/5785	802.11 a	5	0.618	0.197	3.87	8.68	9.00	0.212	2022/11/05

9.2. Simultaneous Transmission Analysis

Refer to EN 62209-2:2010 Annex K, the secondary transmitter SAR test exclusion thresholds are determined by:

$$P_{\text{available}} = P_{\text{th,m}} \left(\frac{\text{SAR}_{\text{lim}} - \text{SAR}_1}{\text{SAR}_{\text{lim}}} \right)$$

$P_{\text{th,m}}$ is the threshold exclusion power level taken from Annex B of EN 62479.

Mode	P_{max} (dBm)	P_{max} (mW)	$P_{\text{th,m}}$ (mW)	SAR_{lim} (W/Kg)	SAR_1 (W/Kg)	Calculation Result (mW)	Simultaneous Transmission Exclusion
Bluetooth	7.50	5.62	20	2	0.841	11.59	YES
Bluetooth	7.50	5.62	40	4	3.017	9.83	YES
NFC	0.57	1.14	20	2	0.841	11.59	YES
NFC	0.57	1.14	40	4	3.017	9.83	YES

9.3. Exposure Conditions

Exposure Position		WWAN Band	WLAN Band	Simultaneous Tx SAR(W/Kg)
		SAR(W/Kg)	SAR(W/Kg)	
Head	Left Cheek	0.263	0.964	1.227
	Left Tilt 15 Degree	0.133	0.512	0.645
	Right Cheek	0.238	0.878	1.116

	Right Tilt 15 Degree	0.131	0.437	0.568
Member	Front Side	1.613	0.485	2.098
	Back Side	3.017	0.807	3.824
	Left Side	0.983	0.130	1.113
	Right Side	0.408	0.323	0.731
	Top Side	0.305	0.387	0.692
	Bottom Side	1.471	0.103	1.574
Body&Hotspot	Back Side	0.841	0.391	1.232

NOTE: The Simultaneous Tx is calculated based on the same configuration and test position.

10. Appendix A. Photo documentation

Test Positions

Left Cheek

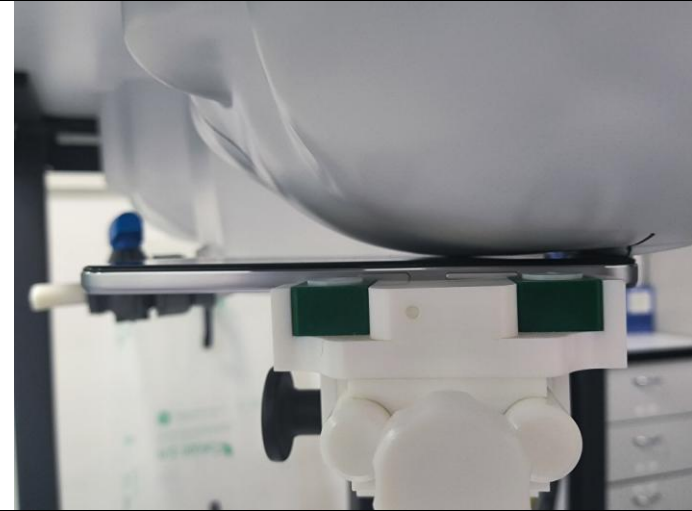

Left Tilt 15 Degree



Right Cheek

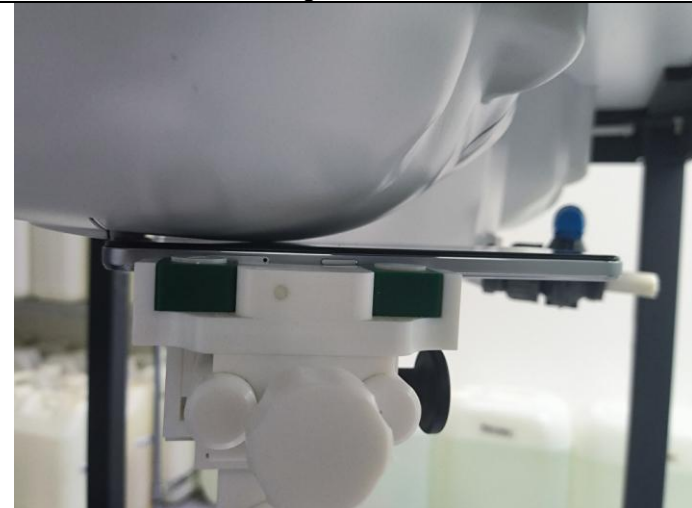

Right Tilt 15 Degree

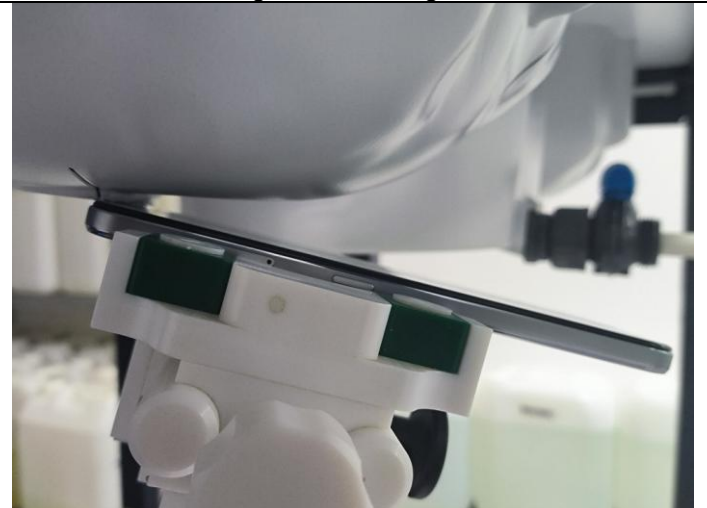



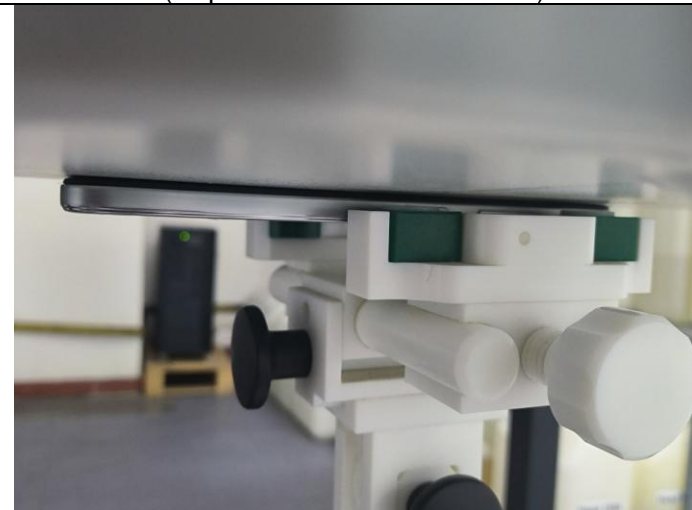

Front Side
(Separation distance of 0mm)

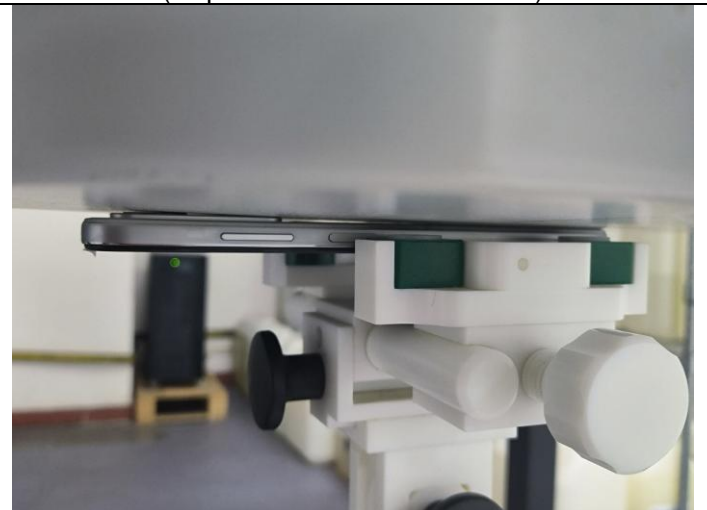

Back Side
(Separation distance of 0mm)



<p>Left Side (Separation distance of 0mm)</p>	<p>Right Side (Separation distance of 0mm)</p>
	
<p>Top Side (Separation distance of 0mm)</p>	<p>Bottom Side (Separation distance of 0mm)</p>
	
<p>Back Side (Separation distance of 5mm)</p>	<p>N/A</p>
	<p>N/A</p>

11. Appendix B. System Check Plots

Table of contents
MEASUREMENT 1 System Performance Check - 900MHz
MEASUREMENT 2 System Performance Check - 1800MHz
MEASUREMENT 3 System Performance Check - 2000MHz
MEASUREMENT 4 System Performance Check - 2300MHz
MEASUREMENT 5 System Performance Check - 2450MHz
MEASUREMENT 6 System Performance Check - 2600MHz
MEASUREMENT 7 System Performance Check - 5200MHz
MEASUREMENT 8 System Performance Check - 5800MHz

MEASUREMENT 1

Date of measurement: 7/11/2022

A. Experimental conditions.

Area Scan	<u>dx=15mm dy=15mm, h= 5.00 mm</u>
ZoomScan	<u>5x5x7, dx=8mm dy=8mm dz=5mm</u>
Phantom	<u>Validation plane</u>
Device Position	<u>Dipole</u>
Band	<u>CW900</u>
Channels	<u>Middle</u>
Signal	<u>CW (Crest factor: 1.0)</u>
ConvF	<u>1.61</u>

B. SAR Measurement Results

Frequency (MHz)	900.000000
Relative permittivity (real part)	39.855753
Relative permittivity (imaginary part)	19.439411
Conductivity (S/m)	0.971971
Variation (%)	2.730000

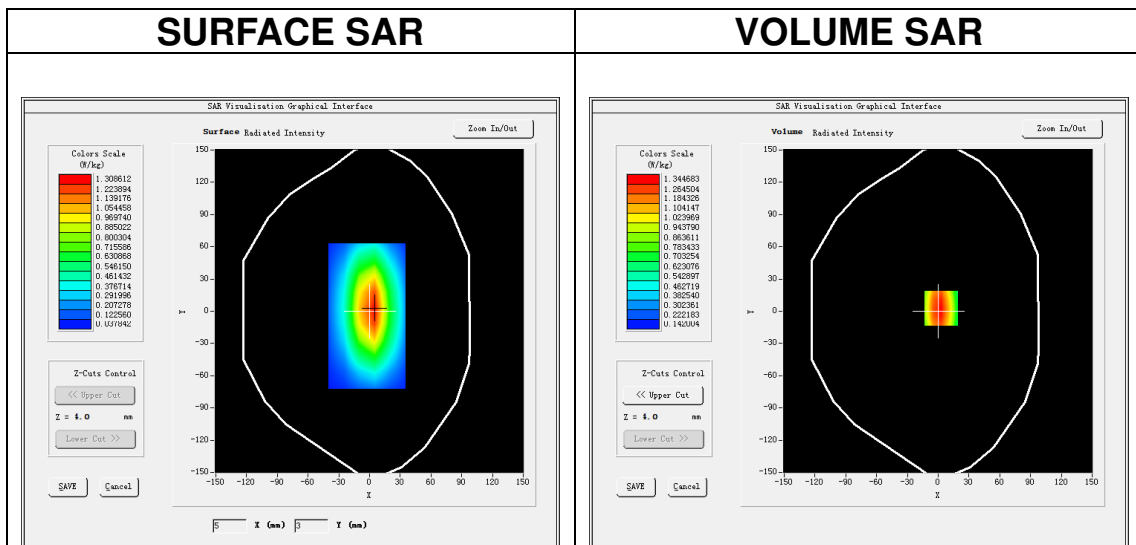

Maximum location: X=3.00, Y=3.00
SAR Peak: 1.84 W/kg

SAR 10g (W/Kg)	0.722364
SAR 1g (W/Kg)	1.107272

Z (mm)	0.00	4.00	9.00	14.00	19.00	24.00	29.00
SAR (W/Kg)	1.8303	1.3447	0.9213	0.6481	0.4622	0.3367	0.2475

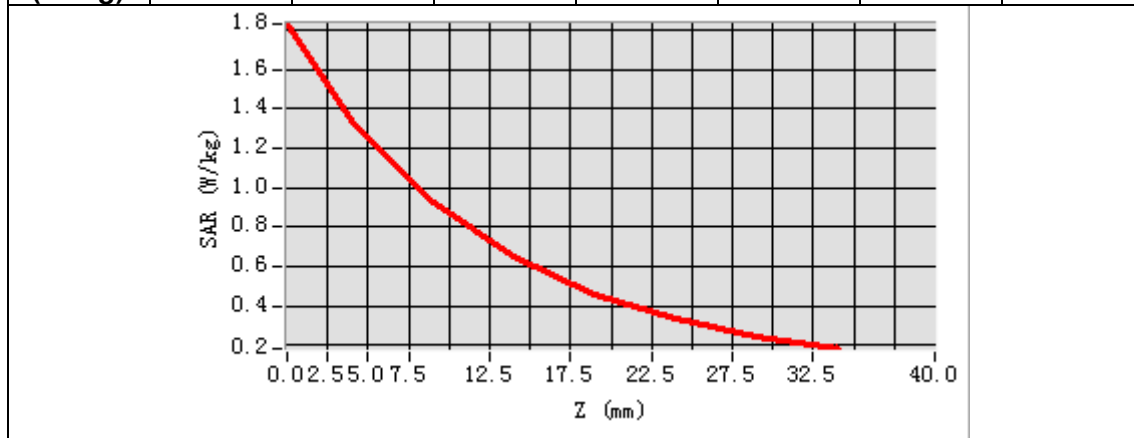

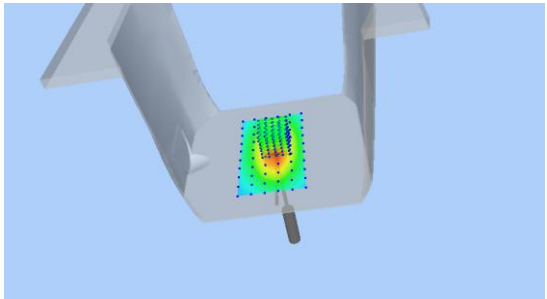
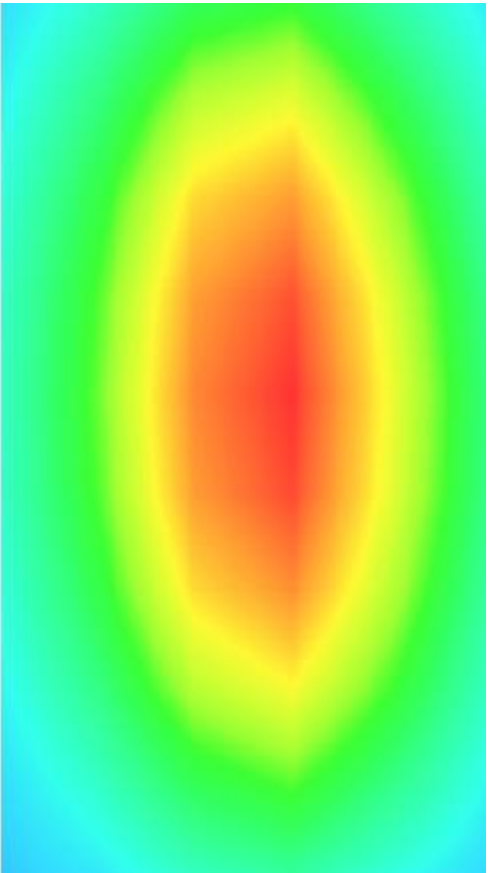
3D screen shot	Hot spot position
 <p>A 3D perspective view of a grey device. A small rectangular area on the front face is highlighted with a color-coded grid, showing a red and yellow hot spot in the center, transitioning to green and blue towards the edges.</p>	 <p>A 2D heatmap showing the spatial distribution of the SAR hot spot. The center is a bright red oval, surrounded by a yellow ring, then a green ring, and finally a cyan outer boundary. The background is light blue.</p>

MEASUREMENT 2

Date of measurement: 28/10/2022

A. Experimental conditions.

Area Scan	<u>dx=15mm dy=15mm, h= 5.00 mm</u>
ZoomScan	<u>5x5x7, dx=8mm dy=8mm dz=5mm</u>
Phantom	<u>Validation plane</u>
Device Position	<u>Dipole</u>
Band	<u>CW1800</u>
Channels	<u>Middle</u>
Signal	<u>CW (Crest factor: 1.0)</u>
ConvF	<u>1.73</u>

B. SAR Measurement Results

Frequency (MHz)	1800.000000
Relative permittivity (real part)	38.621625
Relative permittivity (imaginary part)	13.804764
Conductivity (S/m)	1.380476
Variation (%)	-2.720000

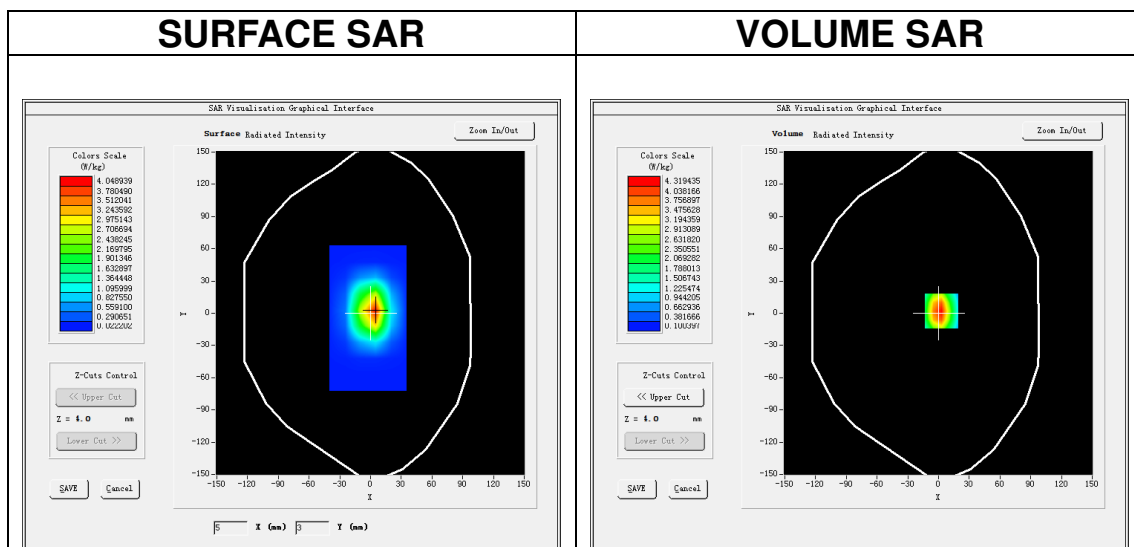

Maximum location: X=3.00, Y=2.00
SAR Peak: 6.82 W/kg

SAR 10g (W/Kg)	2.054333
SAR 1g (W/Kg)	3.431172

Z (mm)	0.00	4.00	9.00	14.00	19.00	24.00	29.00
SAR (W/Kg)	6.7421	4.3159	2.4332	1.4262	0.8563	0.5209	0.3226

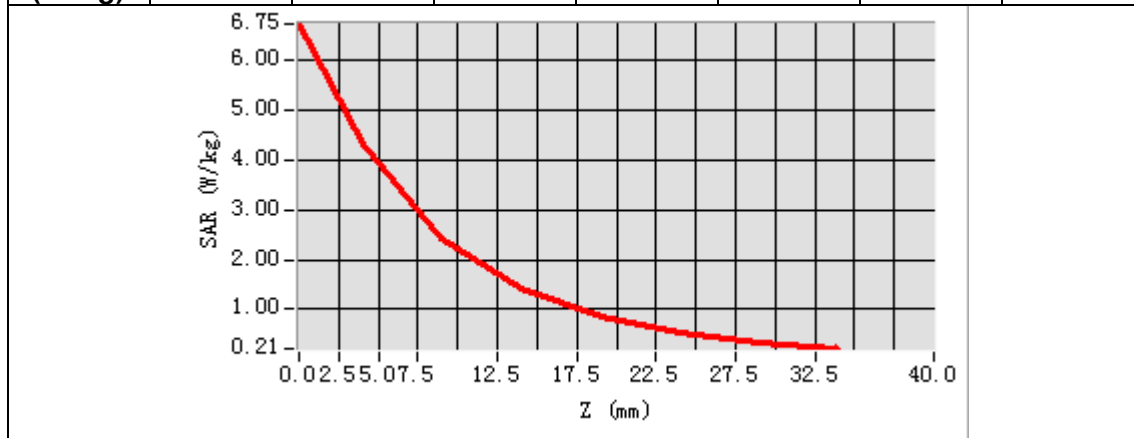

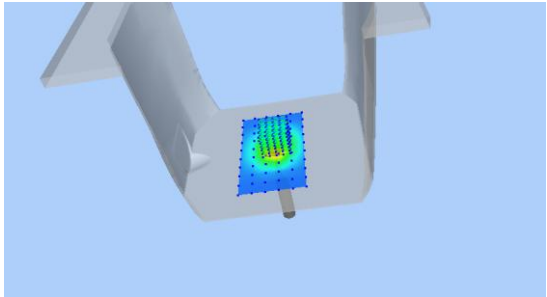
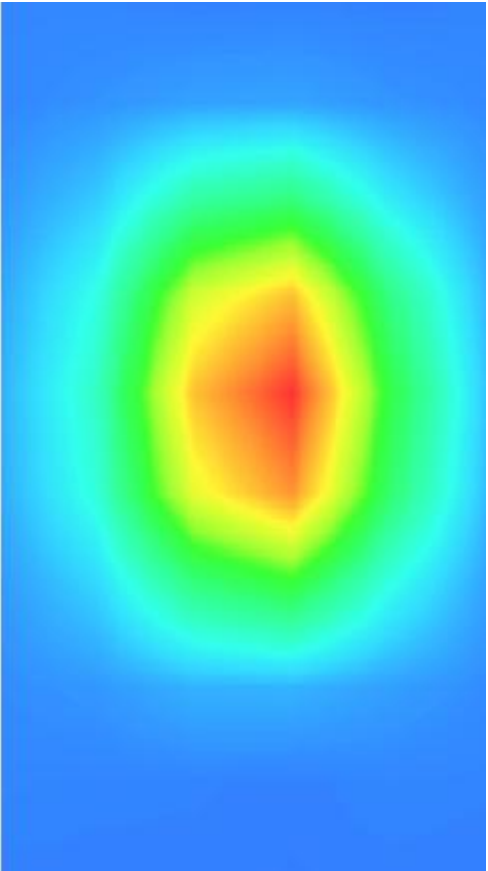
3D screen shot	Hot spot position
	

MEASUREMENT 3

Date of measurement: 8/11/2022

A. Experimental conditions.

Area Scan	<u>dx=15mm dy=15mm, h= 5.00 mm</u>
ZoomScan	<u>5x5x7, dx=8mm dy=8mm dz=5mm</u>
Phantom	<u>Validation plane</u>
Device Position	<u>Dipole</u>
Band	<u>CW2000</u>
Channels	<u>Middle</u>
Signal	<u>CW (Crest factor: 1.0)</u>
ConvF	<u>1.97</u>

B. SAR Measurement Results

Frequency (MHz)	2000.000000
Relative permittivity (real part)	39.512810
Relative permittivity (imaginary part)	12.500921
Conductivity (S/m)	1.388991
Variation (%)	2.980000

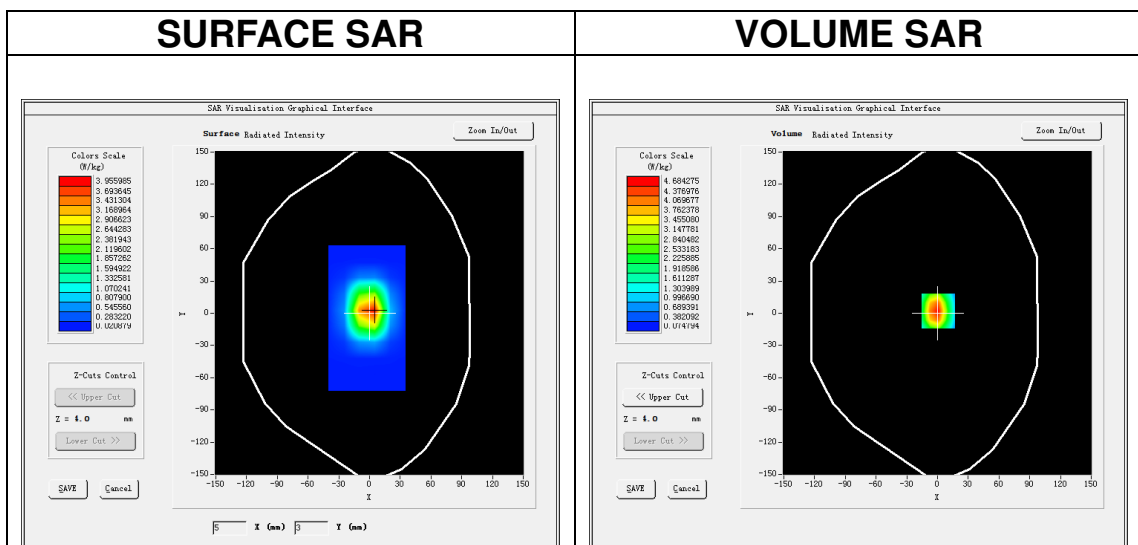

Maximum location: X=1.00, Y=2.00
SAR Peak: 7.65 W/kg

SAR 10g (W/Kg)	1.948307
SAR 1g (W/Kg)	4.488066

Z (mm)	0.00	4.00	9.00	14.00	19.00	24.00	29.00
SAR (W/Kg)	7.5474	4.6811	2.5029	1.3803	0.7772	0.4431	0.2634

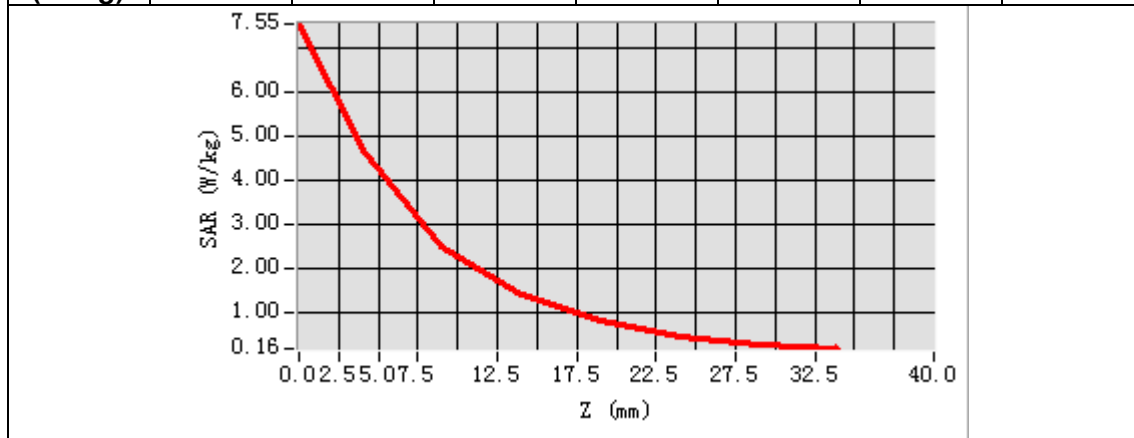

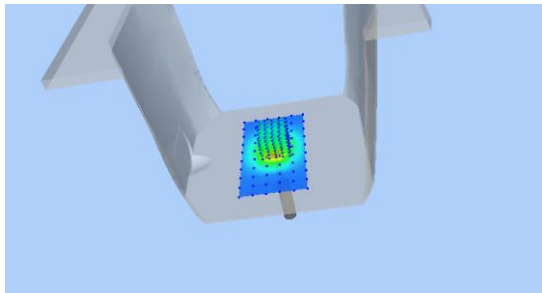
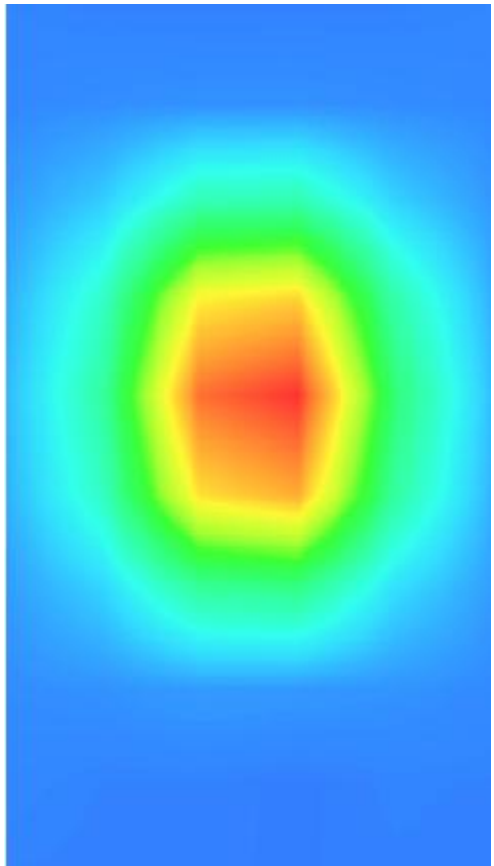
3D screen shot	Hot spot position
	

MEASUREMENT 4

Date of measurement: 9/11/2022

A. Experimental conditions.

Area Scan	<u>dx=12mm dy=12mm, h= 5.00 mm</u>
ZoomScan	<u>7x7x7, dx=5mm dy=5mm dz=5mm</u>
Phantom	<u>Validation plane</u>
Device Position	<u>Dipole</u>
Band	<u>CW2300</u>
Channels	<u>Middle</u>
Signal	<u>CW (Crest factor: 1.0)</u>
ConvF	<u>1.92</u>

B. SAR Measurement Results

Frequency (MHz)	2300.000000
Relative permittivity (real part)	37.837640
Relative permittivity (imaginary part)	13.050878
Conductivity (S/m)	1.667612
Variation (%)	2.220000

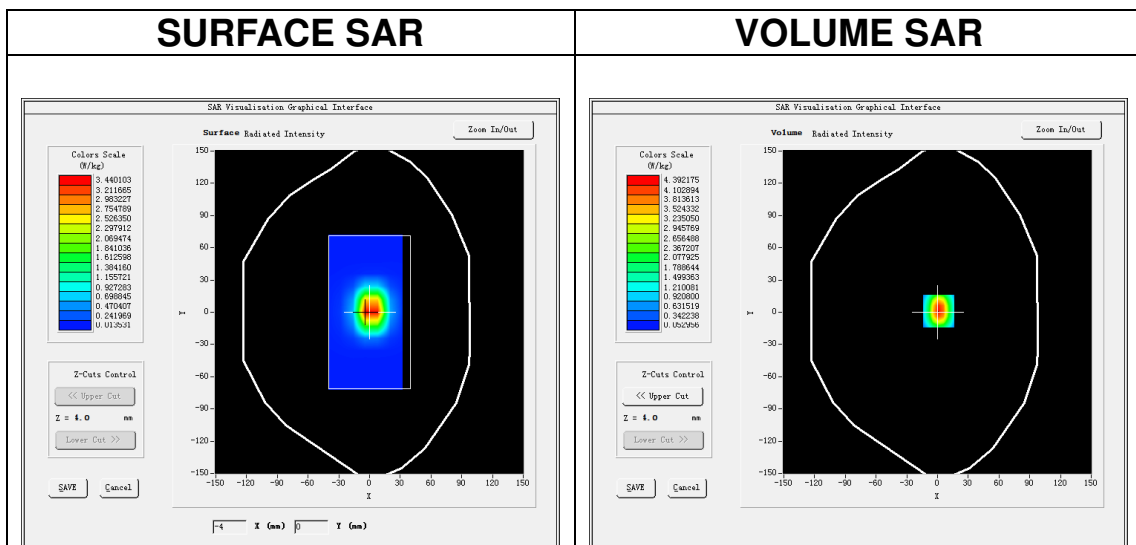

Maximum location: X=1.00, Y=1.00
SAR Peak: 7.04 W/kg

SAR 10g (W/Kg)	2.390347
SAR 1g (W/Kg)	5.095221

Z (mm)	0.00	4.00	9.00	14.00	19.00	24.00	29.00
SAR (W/Kg)	7.0347	4.3919	2.3630	1.2726	0.7118	0.4014	0.2394

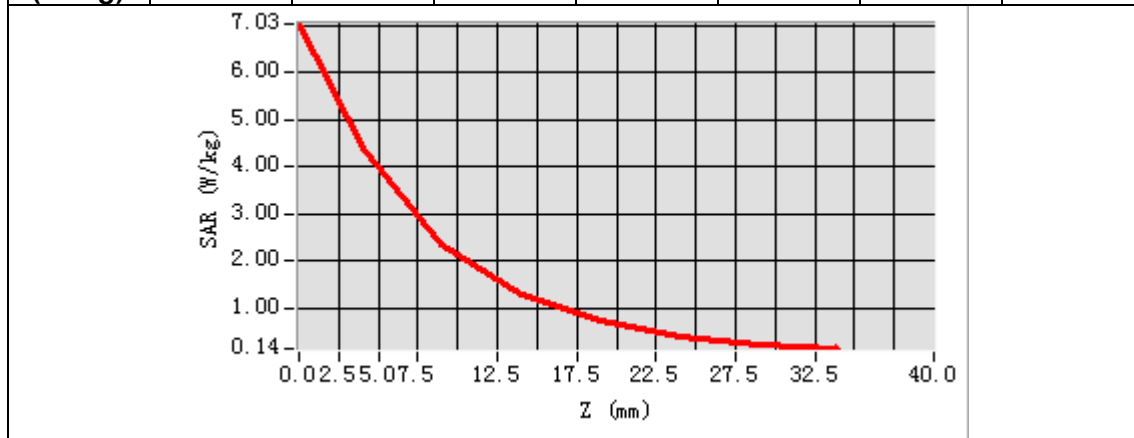

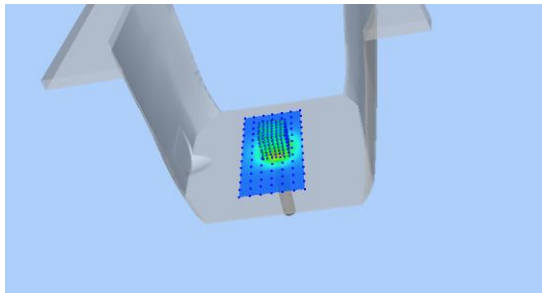
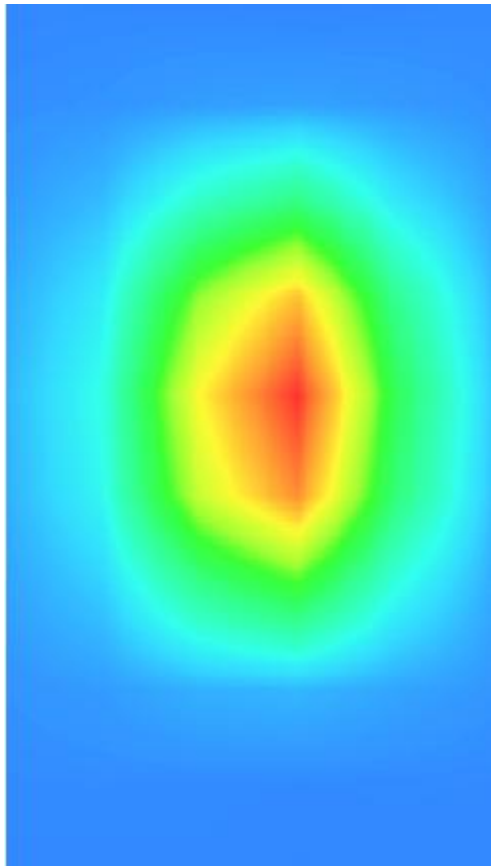
3D screen shot	Hot spot position
	

MEASUREMENT 5

Date of measurement: 1/11/2022

A. Experimental conditions.

Area Scan	<u>dx=12mm dy=12mm, h= 5.00 mm</u>
ZoomScan	<u>7x7x7,dx=5mm dy=5mm dz=5mm</u>
Phantom	<u>Validation plane</u>
Device Position	<u>Dipole</u>
Band	<u>CW2450</u>
Channels	<u>Middle</u>
Signal	<u>CW (Crest factor: 1.0)</u>
ConvF	<u>1.98</u>

B. SAR Measurement Results

Frequency (MHz)	2450.000000
Relative permittivity (real part)	37.567995
Relative permittivity (imaginary part)	13.008427
Conductivity (S/m)	1.770591
Variation (%)	1.290000

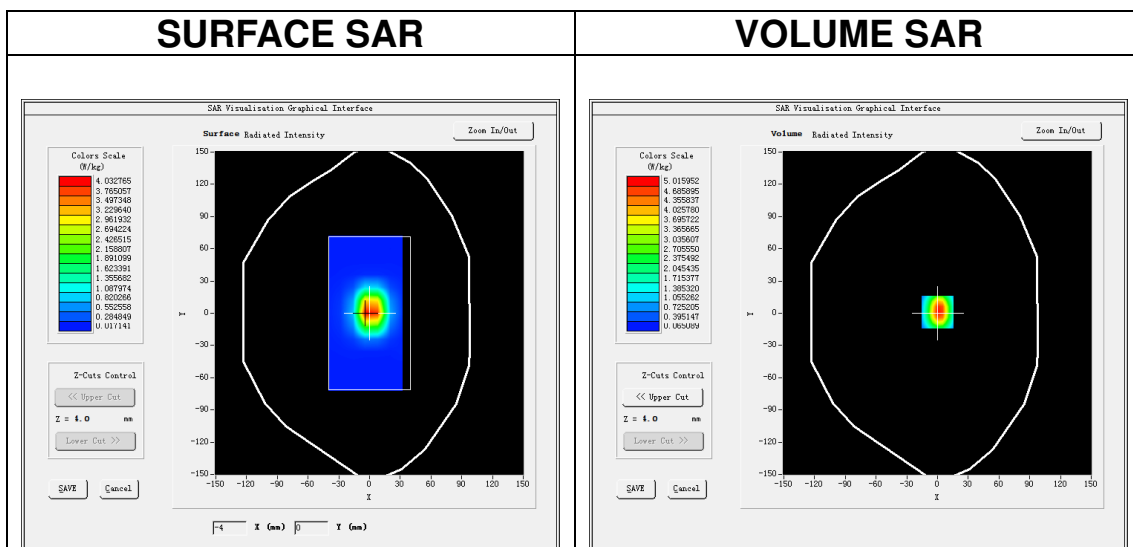

Maximum location: X=0.00, Y=1.00
SAR Peak: 8.14 W/kg

SAR 10g (W/Kg)	2.332106
SAR 1g (W/Kg)	5.695340

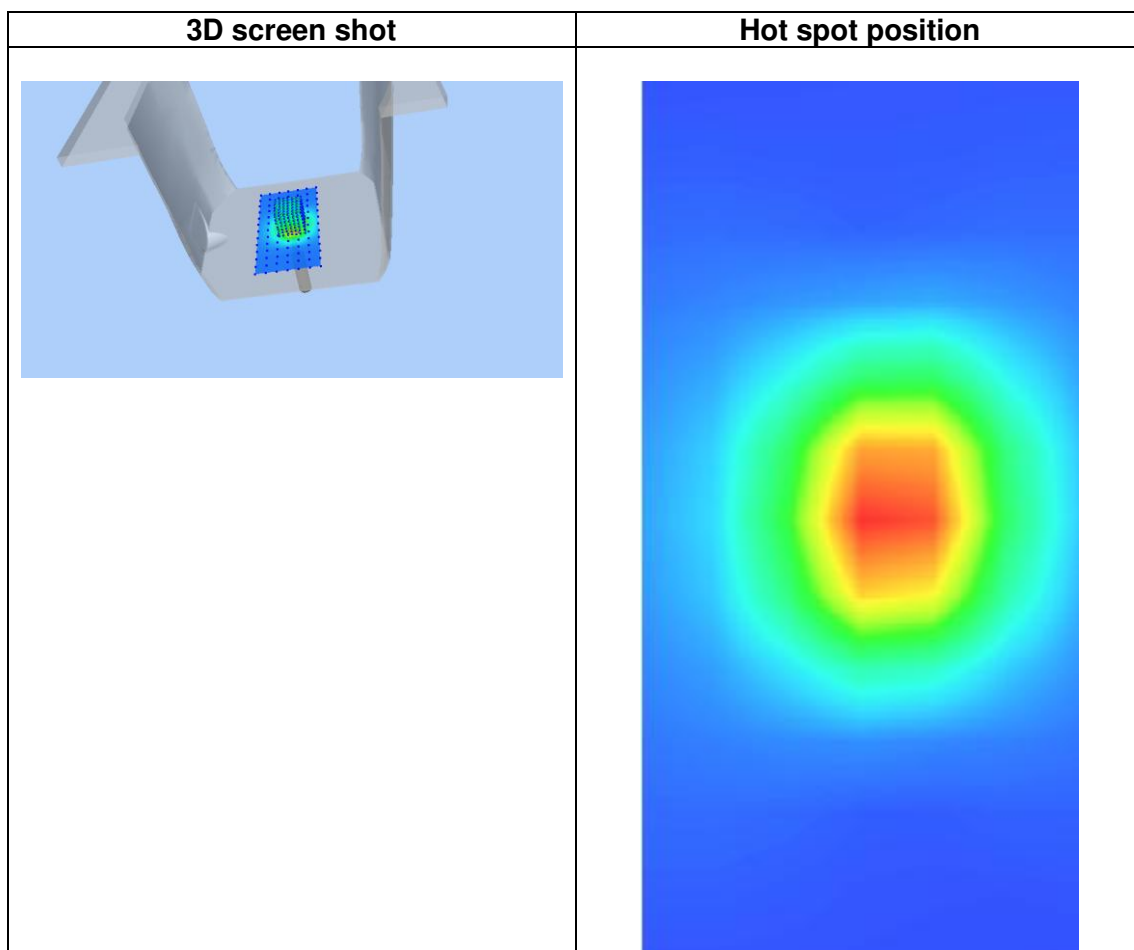
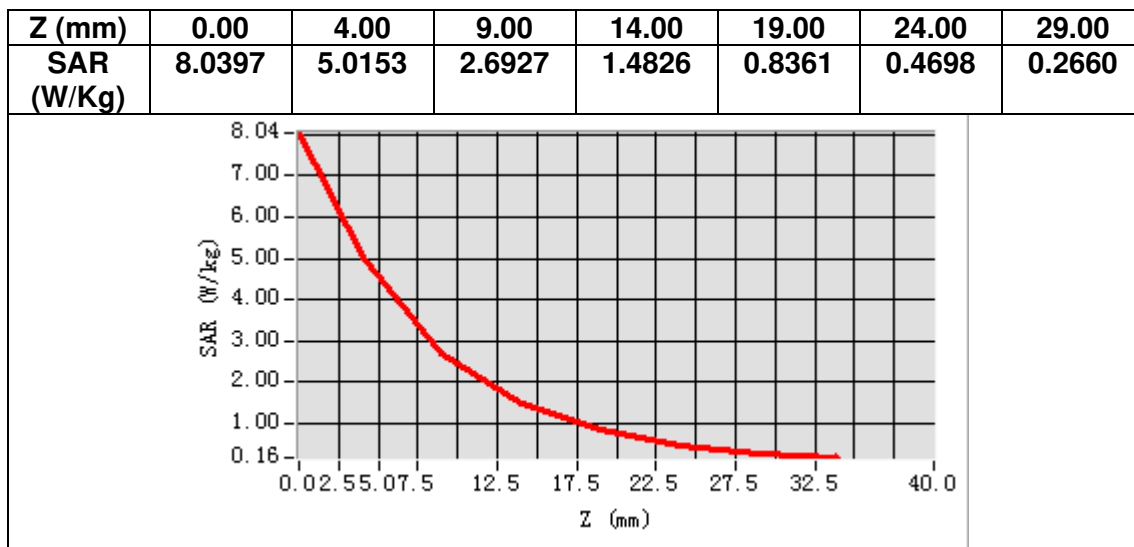

MEASUREMENT 6

Date of measurement: 10/11/2022

A. Experimental conditions.

Area Scan	<u>dx=12mm dy=12mm, h= 5.00 mm</u>
ZoomScan	<u>7x7x7,dx=5mm dy=5mm dz=5mm</u>
Phantom	<u>Validation plane</u>
Device Position	<u>Dipole</u>
Band	<u>CW2600</u>
Channels	<u>Middle</u>
Signal	<u>CW (Crest factor: 1.0)</u>
ConvF	<u>1.87</u>

B. SAR Measurement Results

Frequency (MHz)	2600.000000
Relative permittivity (real part)	37.826719
Relative permittivity (imaginary part)	13.469406
Conductivity (S/m)	1.945581
Variation (%)	0.250000

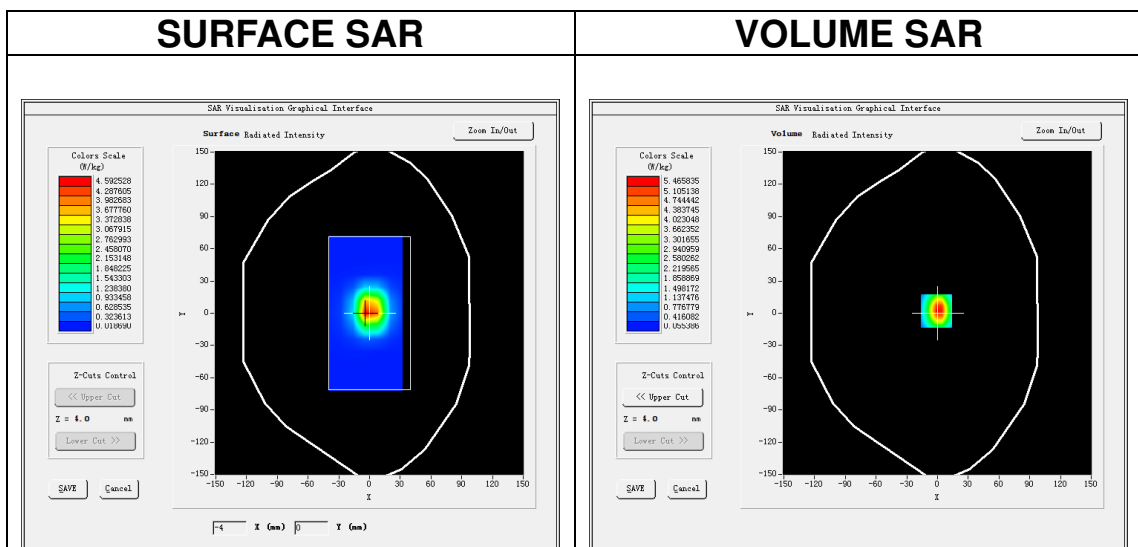

Maximum location: X=-1.00, Y=2.00
SAR Peak: 9.07 W/kg

SAR 10g (W/Kg)	2.625037
SAR 1g (W/Kg)	5.070199

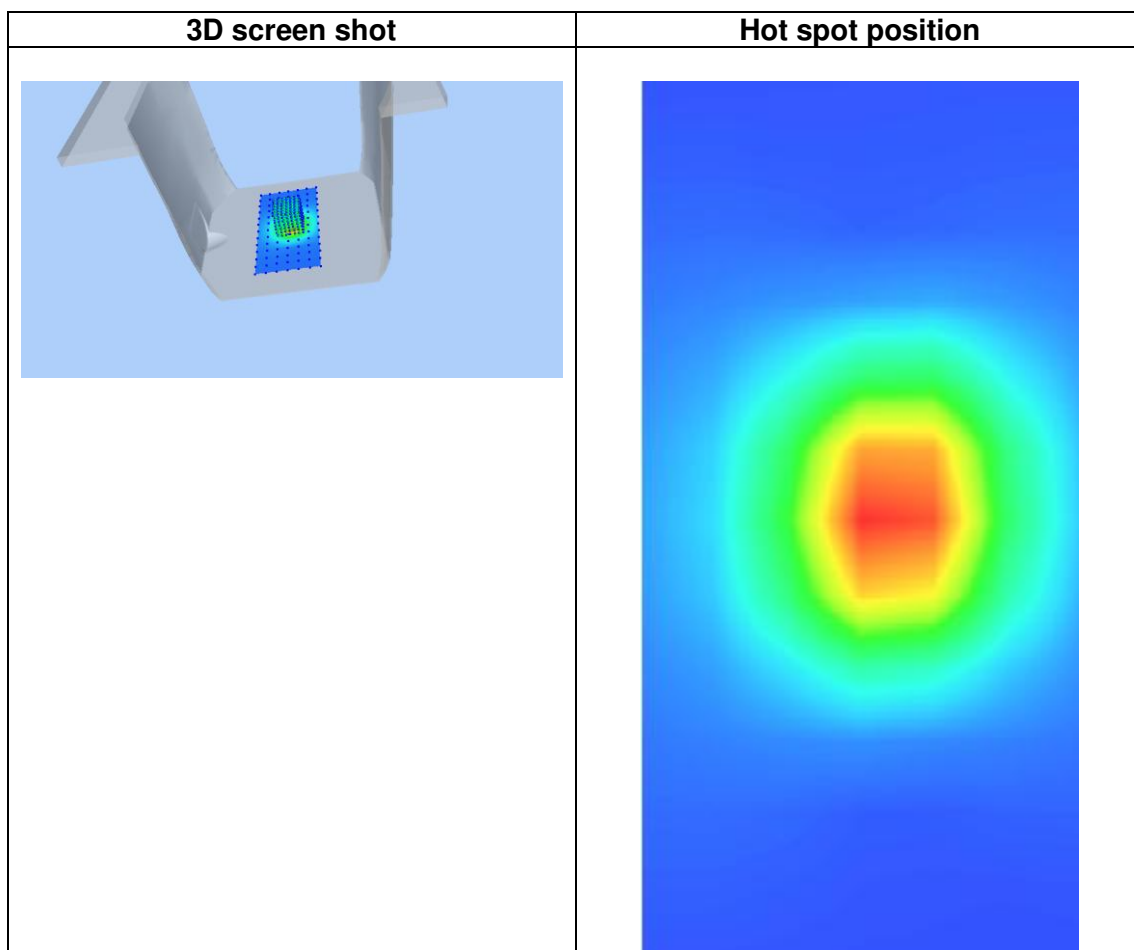
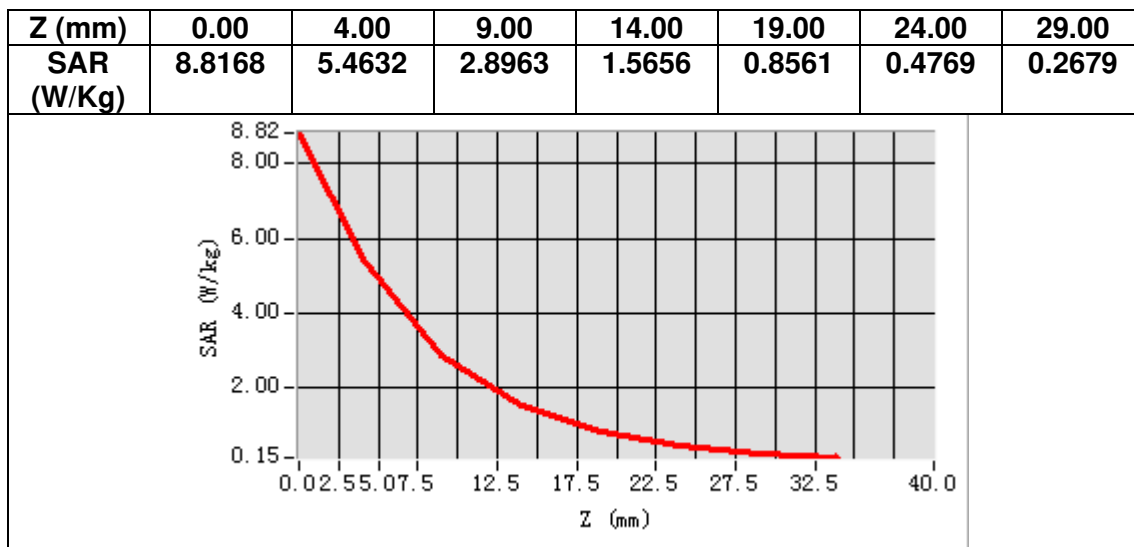

MEASUREMENT 7

Date of measurement: 4/11/2022

A. Experimental conditions.

Area Scan	<u>dx=10mm dy=10mm, h= 2.00 mm</u>
ZoomScan	<u>7x7x12,dx=4mm dy=4mm dz=2mm</u>
Phantom	<u>Validation plane</u>
Device Position	<u>Dipole</u>
Band	<u>CW5200</u>
Channels	<u>Middle</u>
Signal	<u>CW (Crest factor: 1.0)</u>
ConvF	<u>1.80</u>

B. SAR Measurement Results

Frequency (MHz)	5200.000000
Relative permittivity (real part)	35.506922
Relative permittivity (imaginary part)	16.157523
Conductivity (S/m)	4.667729
Variation (%)	2.800000

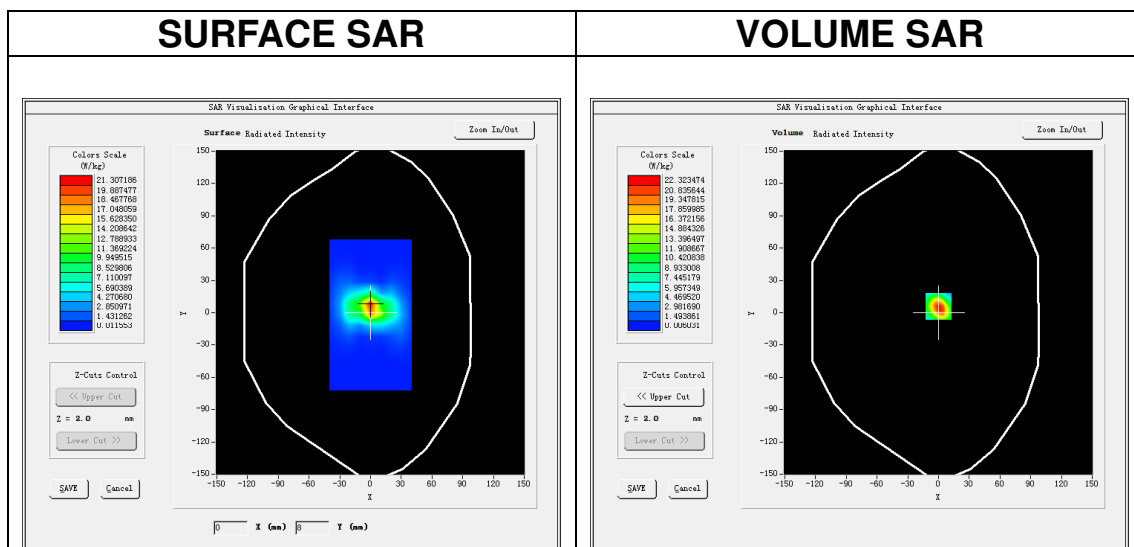

Maximum location: X=0.00, Y=6.00
SAR Peak: 40.06 W/kg

SAR 10g (W/Kg)	5.584162
SAR 1g (W/Kg)	15.716032

Z (m m)	0.00	2.00	4.00	6.00	8.00	10.00	12.00	14.00	16.00	18.00	20.00	22.00
SAR (W/Kg)	37.891	22.391	11.377	5.6694	2.8291	1.4043	0.7150	0.3637	0.1802	0.1008	0.0527	0.0397

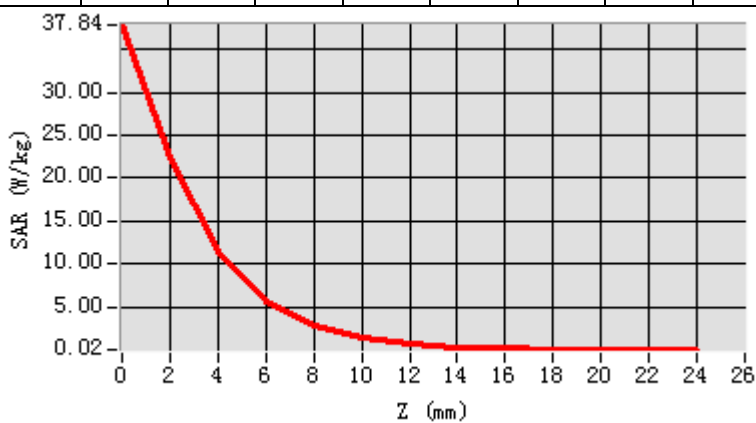

3D screen shot

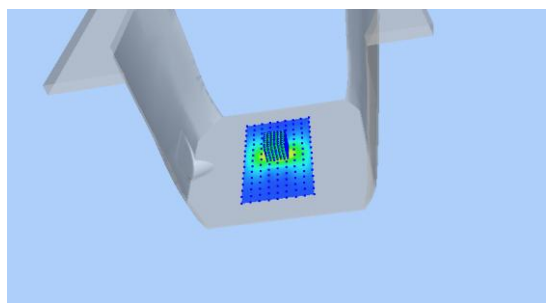

Hot spot position

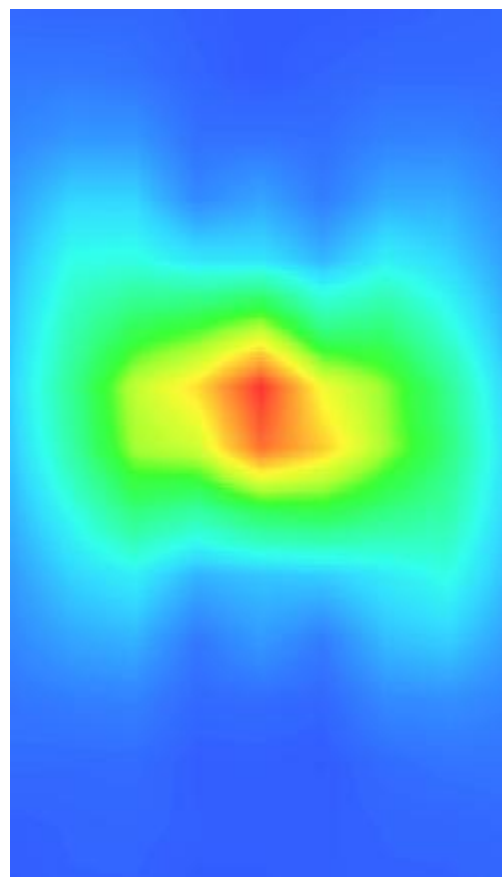

MEASUREMENT 8

Date of measurement: 5/11/2022

A. Experimental conditions.

Area Scan	<u>dx=10mm dy=10mm, h= 2.00 mm</u>
ZoomScan	<u>7x7x12,dx=4mm dy=4mm dz=2mm</u>
Phantom	<u>Validation plane</u>
Device Position	<u>Dipole</u>
Band	<u>CW5800</u>
Channels	<u>Middle</u>
Signal	<u>CW (Crest factor: 1.0)</u>
ConvF	<u>2.07</u>

B. SAR Measurement Results

Frequency (MHz)	5800.000000
Relative permittivity (real part)	34.083139
Relative permittivity (imaginary part)	15.778984
Conductivity (S/m)	5.084339
Variation (%)	-0.500000

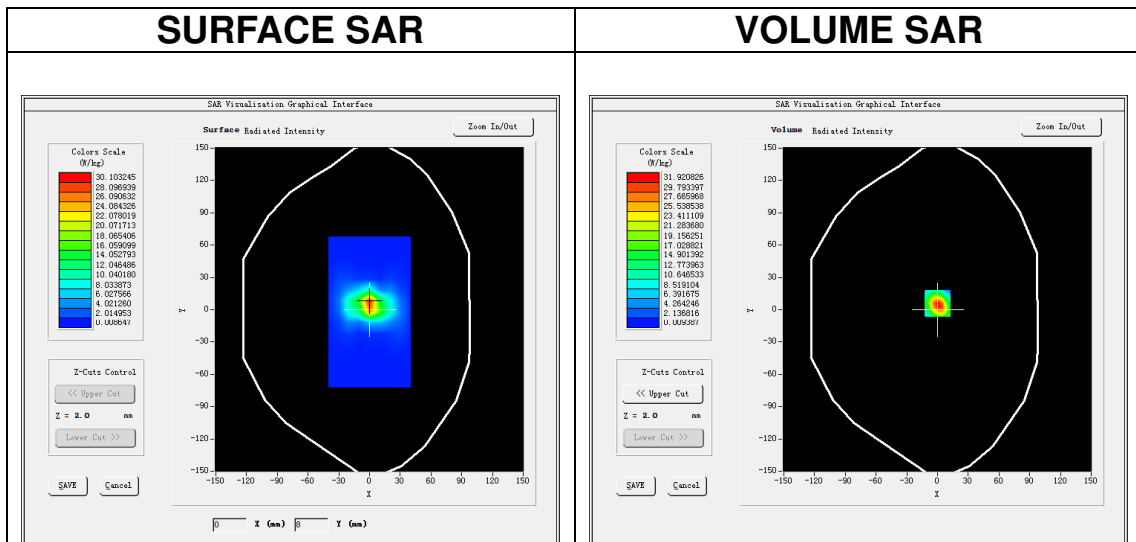

Maximum location: X=0.00, Y=6.00

SAR Peak: 57.37 W/kg

SAR 10g (W/Kg)	6.090228
SAR 1g (W/Kg)	19.077190

Z (m m)	0.00	2.00	4.00	6.00	8.00	10.00	12.00	14.00	16.00	18.00	20.00	22.00
SAR (W/Kg)	54.036	31.948	16.144	8.1766	4.0890	2.0550	1.0361	0.5144	0.2795	0.1572	0.0788	0.0438

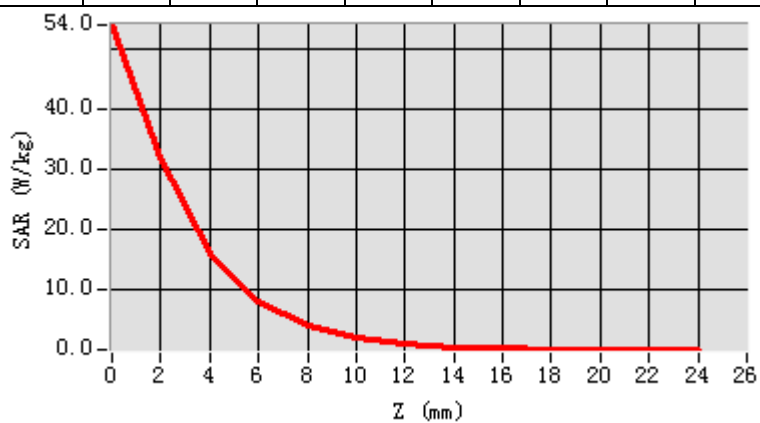

3D screen shot

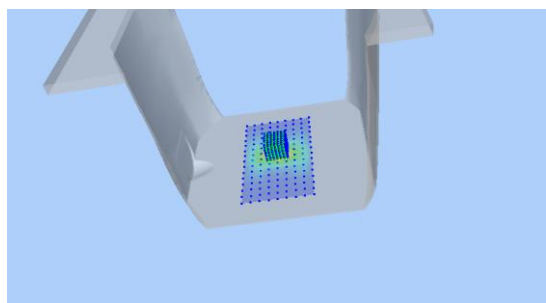

Hot spot position

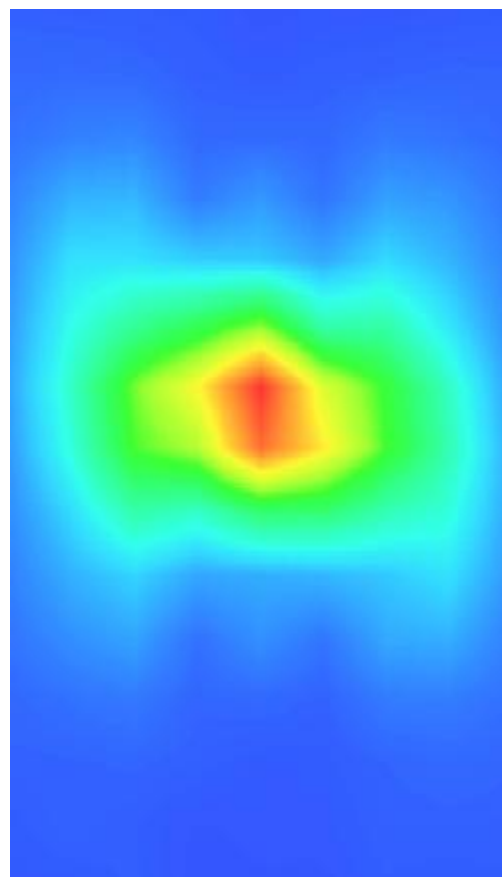

12. Appendix C. Plots of High SAR Measurement

Table of contents
MEASUREMENT 1 GSM 900 Head
MEASUREMENT 2 GSM 900 Extremity
MEASUREMENT 3 GSM 1800 Head
MEASUREMENT 4 GSM 1800 Extremity
MEASUREMENT 5 WCDMA Band 1 Head
MEASUREMENT 6 WCDMA Band 1 Extremity
MEASUREMENT 7 WCDMA Band 8 Head
MEASUREMENT 8 WCDMA Band 8 Extremity
MEASUREMENT 9 WLAN 5.2G Head
MEASUREMENT 10 WLAN 5.8G Head
MEASUREMENT 11 WLAN 5.2G Extremity
MEASUREMENT 12 WLAN 5.8G Extremity
MEASUREMENT 13 WLAN 2.4G Head
MEASUREMENT 14 WLAN 2.4G Extremity
MEASUREMENT 15 LTE Band 1 Head
MEASUREMENT 16 LTE Band 1 Extremity
MEASUREMENT 17 LTE Band 3 Head
MEASUREMENT 18 LTE Band 3 Extremity
MEASUREMENT 19 LTE Band 7 Head
MEASUREMENT 20 LTE Band 7 Extremity
MEASUREMENT 21 LTE Band 8 Head
MEASUREMENT 22 LTE Band 8 Extremity
MEASUREMENT 23 LTE Band 20 Head
MEASUREMENT 24 LTE Band 20 Extremity
MEASUREMENT 25 LTE Band 40 Head
MEASUREMENT 26 LTE Band 40 Extremity

MEASUREMENT 1

Date of measurement: 7/11/2022

A. Experimental conditions.

Area Scan	<u>dx=15mm dy=15mm, h= 5.00 mm</u>
ZoomScan	<u>5x5x7,dx=8mm dy=8mm dz=5mm</u>
Phantom	<u>Left head</u>
Device Position	<u>Cheek</u>
Band	<u>GSM900</u>
Channels	<u>Middle</u>
Signal	<u>TDMA (Crest factor: 2.0)</u>
ConvF	<u>1.61</u>

B. SAR Measurement Results

Frequency (MHz)	897.600000
Relative permittivity (real part)	39.936111
Relative permittivity (imaginary part)	19.493231
Conductivity (S/m)	0.972062
Variation (%)	-1.870000

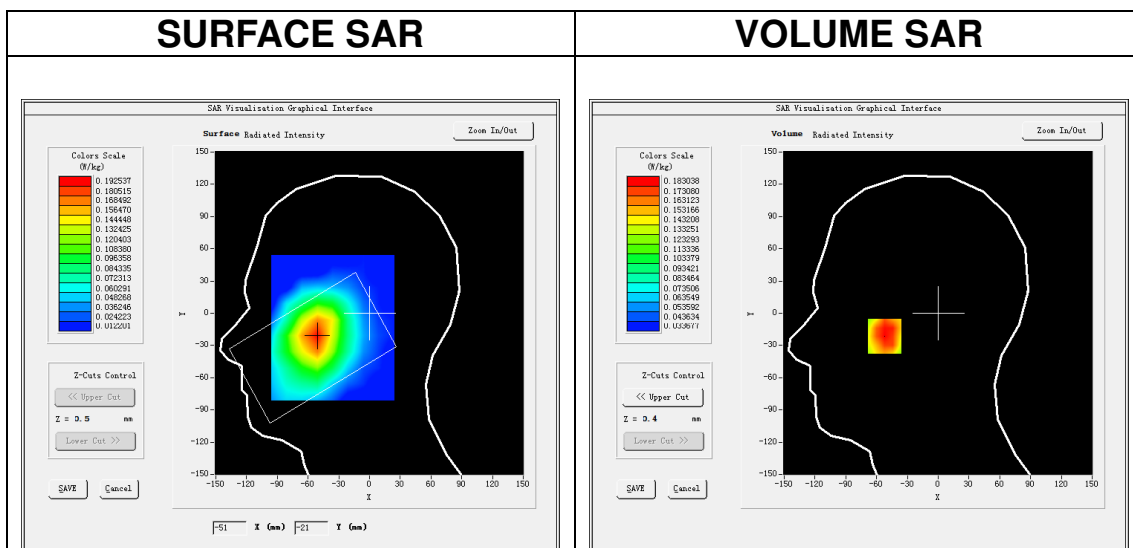

Maximum location: X=-52.00, Y=-21.00
SAR Peak: 0.22 W/kg

SAR 10g (W/Kg)	0.136422
SAR 1g (W/Kg)	0.178772

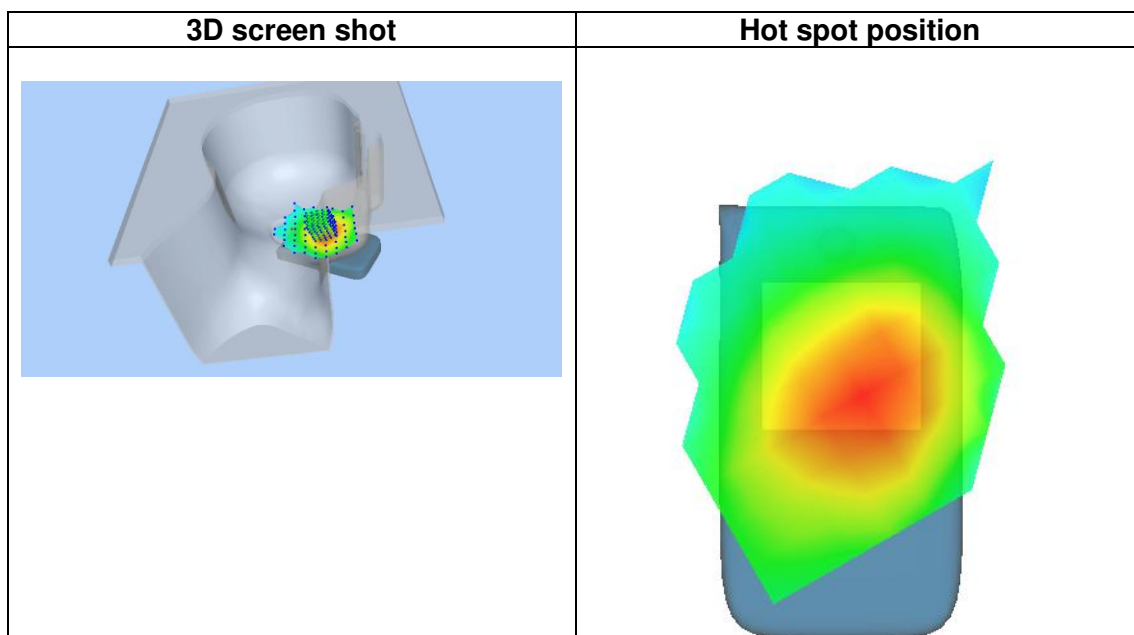
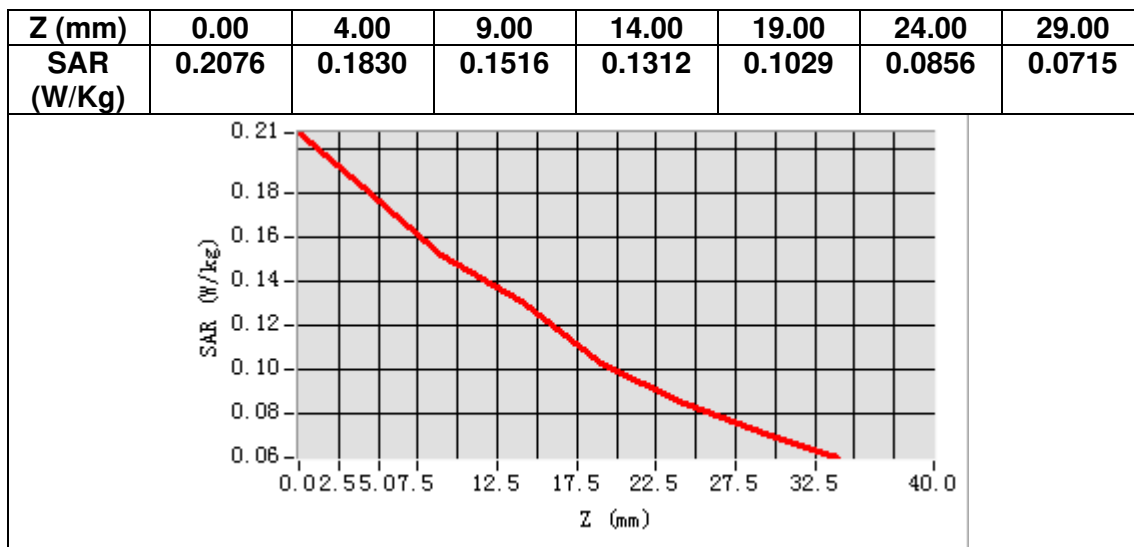

MEASUREMENT 2

Date of measurement: 7/11/2022

A. Experimental conditions.

Area Scan	<u>dx=15mm dy=15mm, h= 5.00 mm</u>
ZoomScan	<u>5x5x7, dx=8mm dy=8mm dz=5mm</u>
Phantom	<u>Validation plane</u>
Device Position	<u>Body</u>
Band	<u>GSM900</u>
Channels	<u>Middle</u>
Signal	<u>TDMA (Crest factor: 2.0)</u>
ConvF	<u>1.61</u>

B. SAR Measurement Results

Frequency (MHz)	897.600000
Relative permittivity (real part)	39.936111
Relative permittivity (imaginary part)	19.493231
Conductivity (S/m)	0.972062
Variation (%)	-1.440000

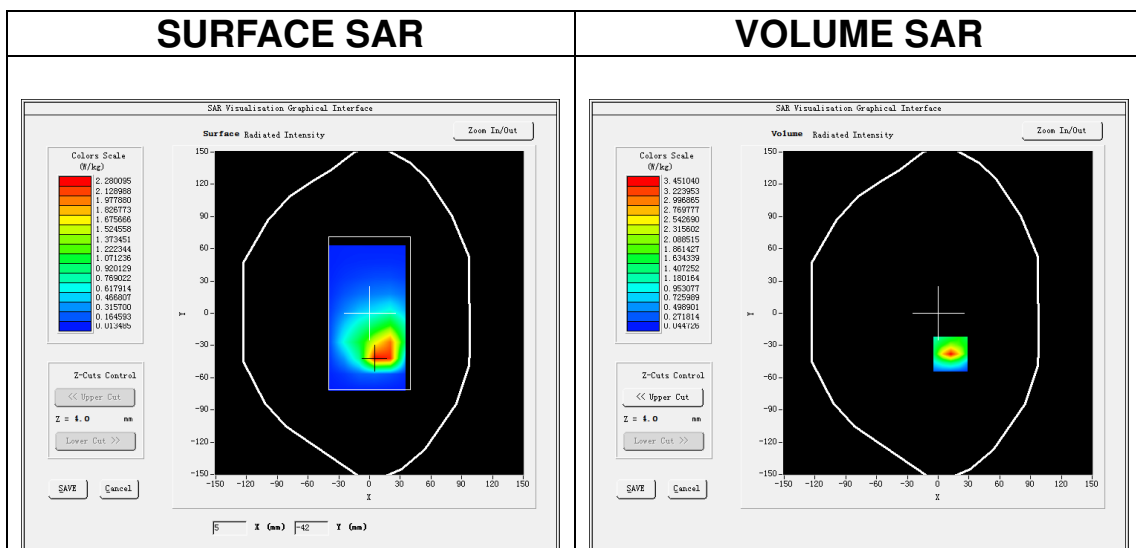

Maximum location: X=12.00, Y=-38.00
SAR Peak: 6.29 W/kg

SAR 10g (W/Kg)	1.340704
SAR 1g (W/Kg)	3.104422

Z (mm)	0.00	4.00	9.00	14.00	19.00	24.00	29.00
SAR (W/Kg)	6.4239	3.4510	1.4561	0.7920	0.4285	0.2606	0.1753

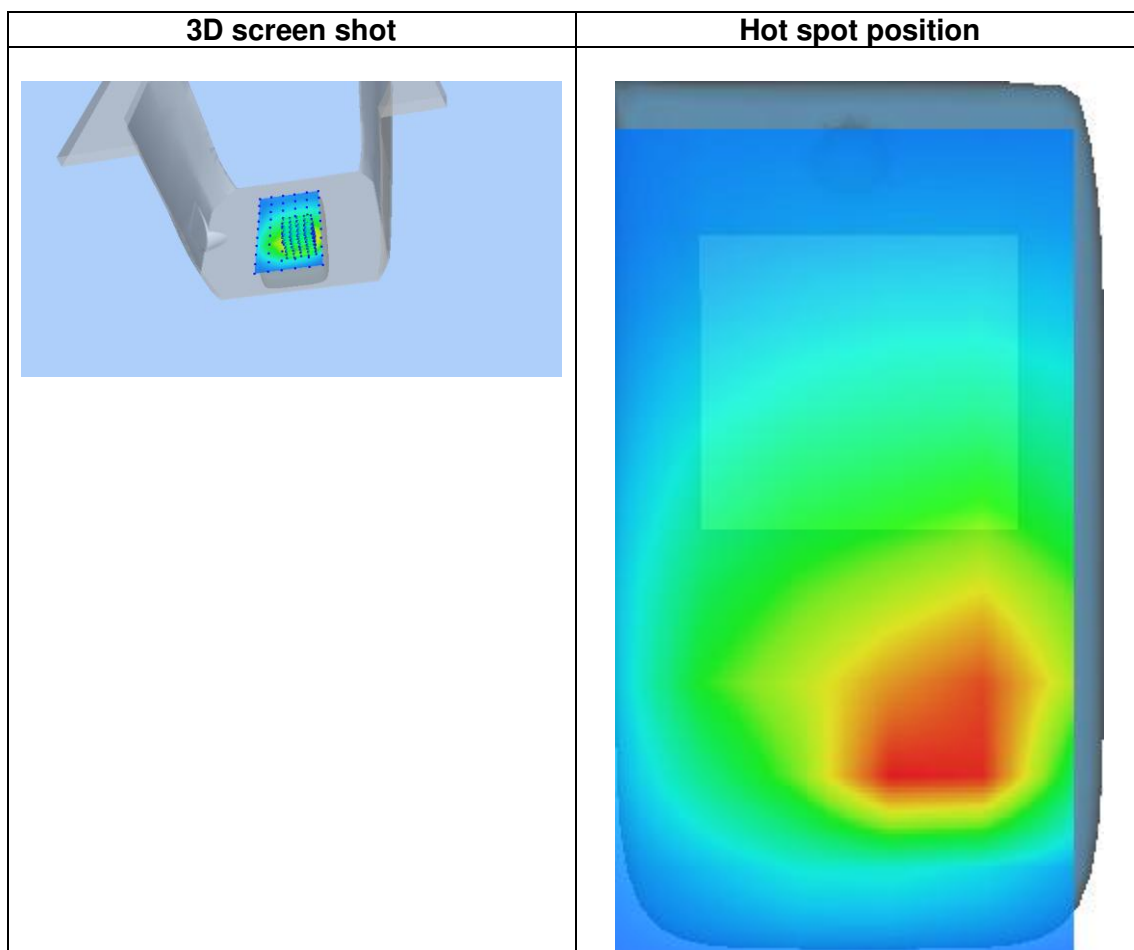
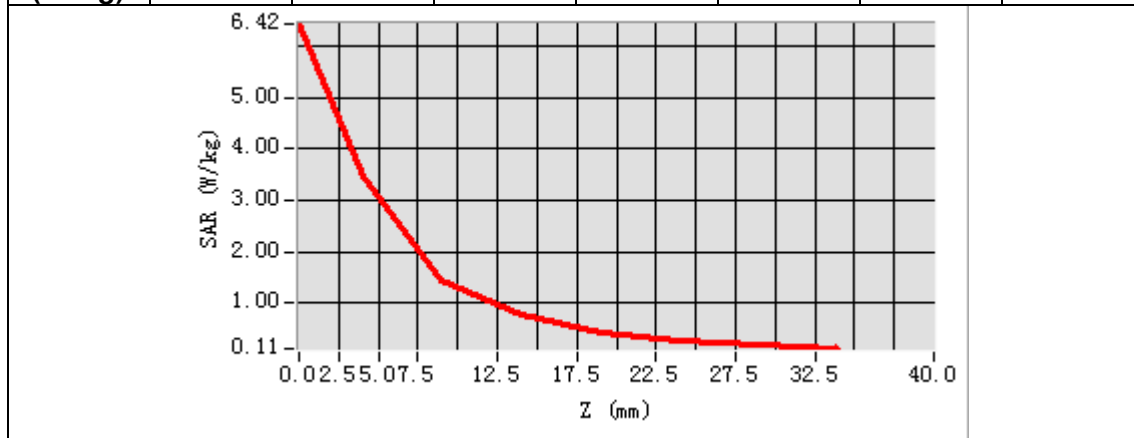

MEASUREMENT 3

Date of measurement: 28/10/2022

A. Experimental conditions.

Area Scan	<u>dx=15mm dy=15mm, h= 5.00 mm</u>
ZoomScan	<u>5x5x7,dx=8mm dy=8mm dz=5mm</u>
Phantom	<u>Left head</u>
Device Position	<u>Cheek</u>
Band	<u>GSM1800</u>
Channels	<u>Middle</u>
Signal	<u>TDMA (Crest factor: 2.0)</u>
ConvF	<u>1.73</u>

B. SAR Measurement Results

Frequency (MHz)	1747.400000
Relative permittivity (real part)	38.976086
Relative permittivity (imaginary part)	13.772644
Conductivity (S/m)	1.337018
Variation (%)	-4.940000

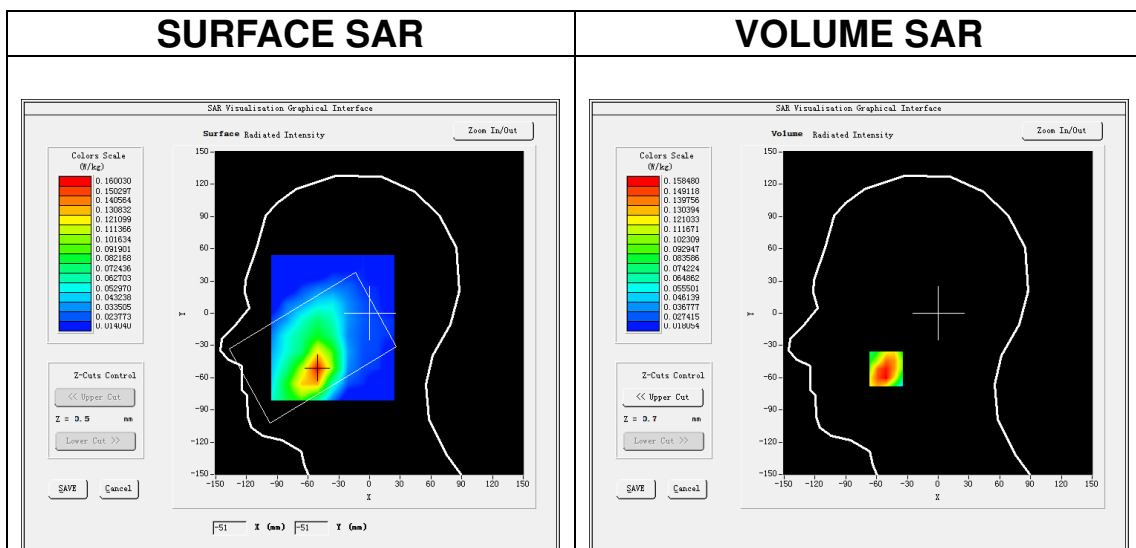

Maximum location: X=-51.00, Y=-52.00
SAR Peak: 0.24 W/kg

SAR 10g (W/Kg)	0.097805
SAR 1g (W/Kg)	0.155163

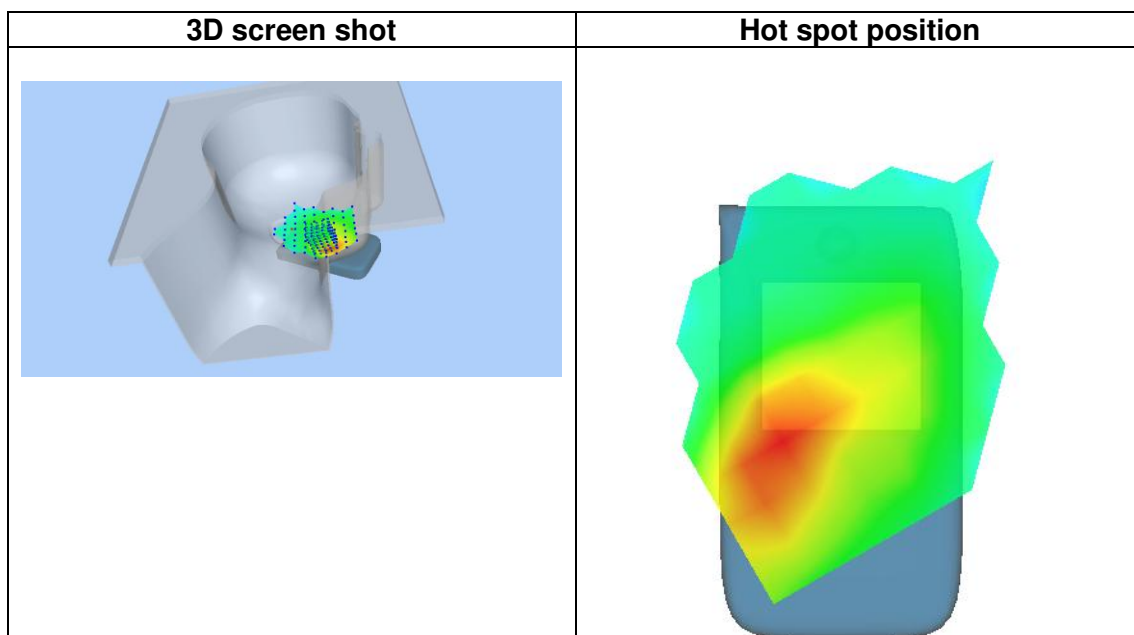
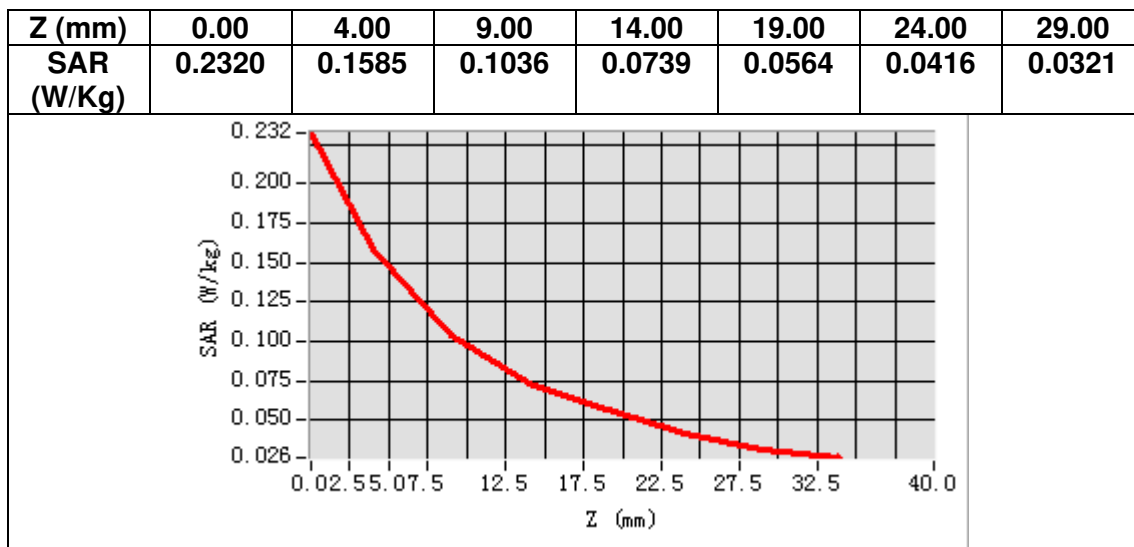

MEASUREMENT 4

Date of measurement: 28/10/2022

A. Experimental conditions.

Area Scan	<u>dx=15mm dy=15mm, h= 5.00 mm</u>
ZoomScan	<u>5x5x7, dx=8mm dy=8mm dz=5mm</u>
Phantom	<u>Validation plane</u>
Device Position	<u>Body</u>
Band	<u>GSM1800</u>
Channels	<u>Middle</u>
Signal	<u>TDMA (Crest factor: 2.0)</u>
ConvF	<u>1.73</u>

B. SAR Measurement Results

Frequency (MHz)	1747.400000
Relative permittivity (real part)	38.976086
Relative permittivity (imaginary part)	13.772644
Conductivity (S/m)	1.337018
Variation (%)	-0.190000

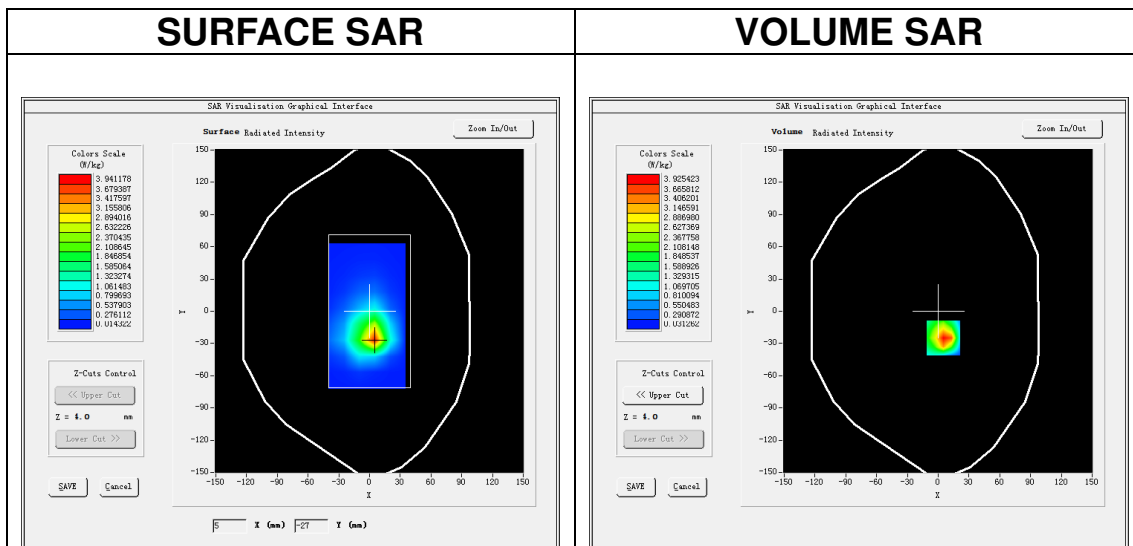

Maximum location: X=5.00, Y=-25.00
SAR Peak: 7.73 W/kg

SAR 10g (W/Kg)	1.637469
SAR 1g (W/Kg)	3.845983

Z (mm)	0.00	4.00	9.00	14.00	19.00	24.00	29.00
SAR (W/Kg)	7.1568	3.9254	1.7059	0.8036	0.4152	0.2124	0.1217

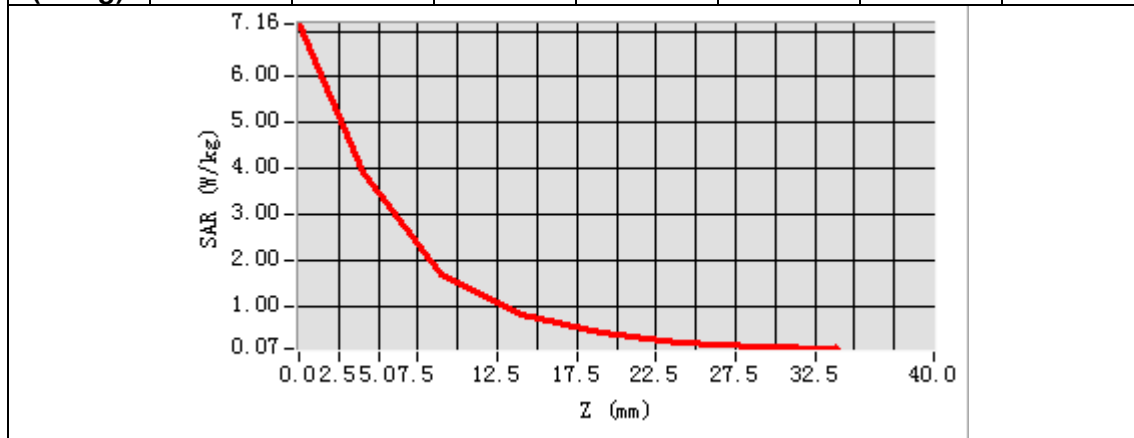

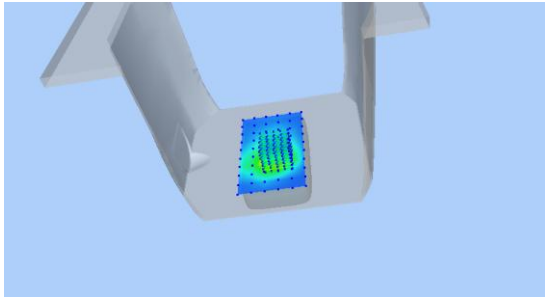
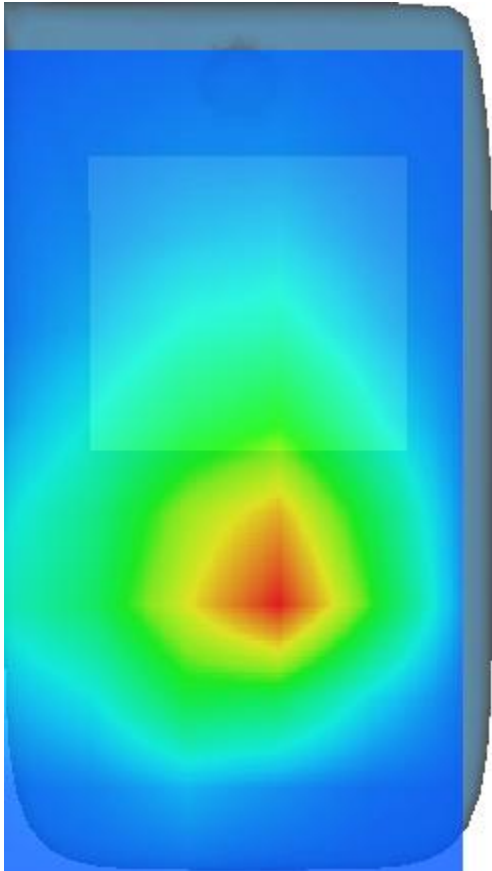
3D screen shot	Hot spot position
	

MEASUREMENT 5

Date of measurement: 8/11/2022

A. Experimental conditions.

Area Scan	<u>dx=15mm dy=15mm, h= 5.00 mm</u>
ZoomScan	<u>5x5x7,dx=8mm dy=8mm dz=5mm</u>
Phantom	<u>Left head</u>
Device Position	<u>Cheek</u>
Band	<u>Band1 UMTS</u>
Channels	<u>Middle</u>
Signal	<u>WCDMA (Crest factor: 1.0)</u>
ConvF	<u>1.97</u>

B. SAR Measurement Results

Frequency (MHz)	1950.000000
Relative permittivity (real part)	39.412312
Relative permittivity (imaginary part)	12.581021
Conductivity (S/m)	1.362944
Variation (%)	2.390000

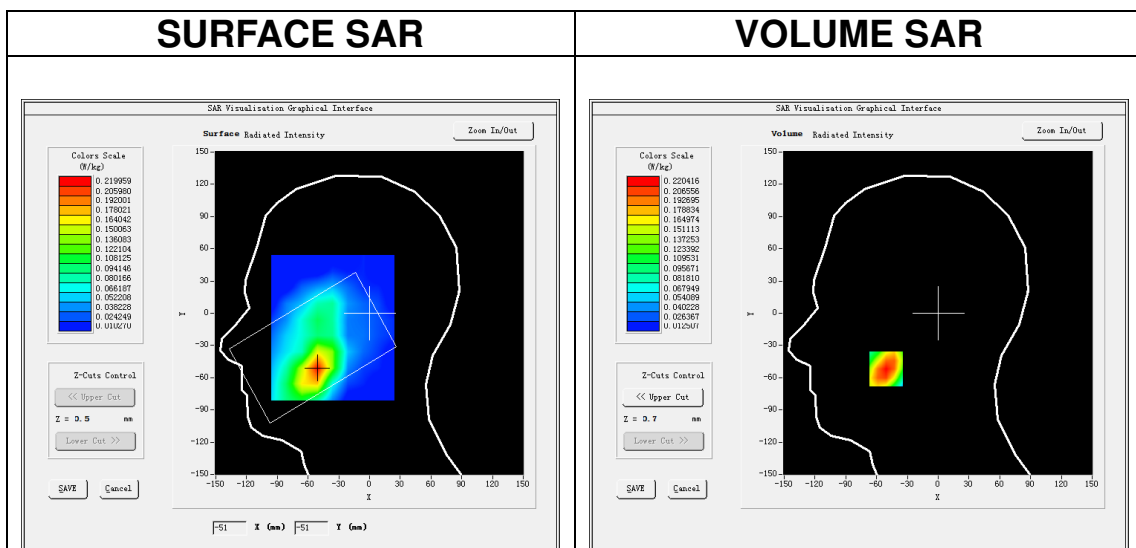

Maximum location: X=-51.00, Y=-52.00
SAR Peak: 0.32 W/kg

SAR 10g (W/Kg)	0.127892
SAR 1g (W/Kg)	0.211090

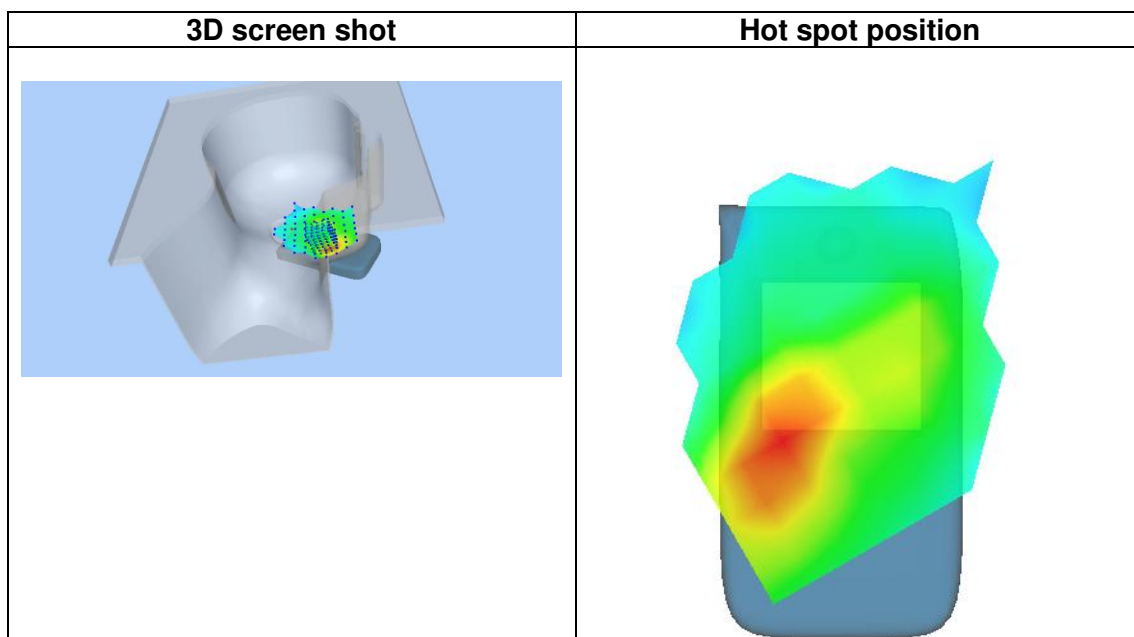
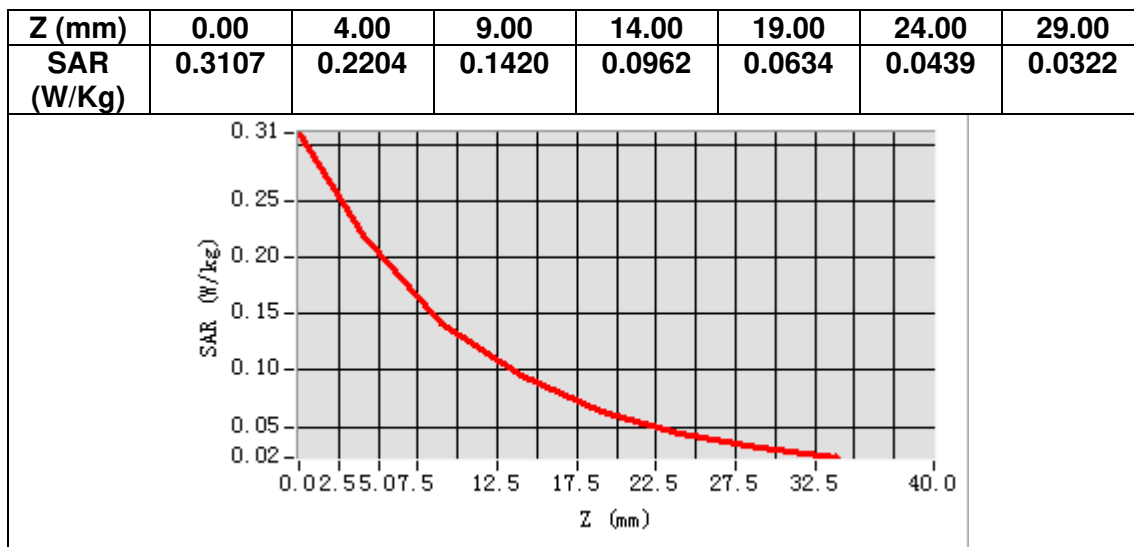

MEASUREMENT 6

Date of measurement: 8/11/2022

A. Experimental conditions.

Area Scan	<u>dx=15mm dy=15mm, h= 5.00 mm</u>
ZoomScan	<u>5x5x7,dx=8mm dy=8mm dz=5mm</u>
Phantom	<u>Validation plane</u>
Device Position	<u>Body</u>
Band	<u>Band1 UMTS</u>
Channels	<u>Middle</u>
Signal	<u>WCDMA (Crest factor: 1.0)</u>
ConvF	<u>1.97</u>

B. SAR Measurement Results

Frequency (MHz)	1950.000000
Relative permittivity (real part)	39.412312
Relative permittivity (imaginary part)	12.581021
Conductivity (S/m)	1.362944
Variation (%)	-0.910000

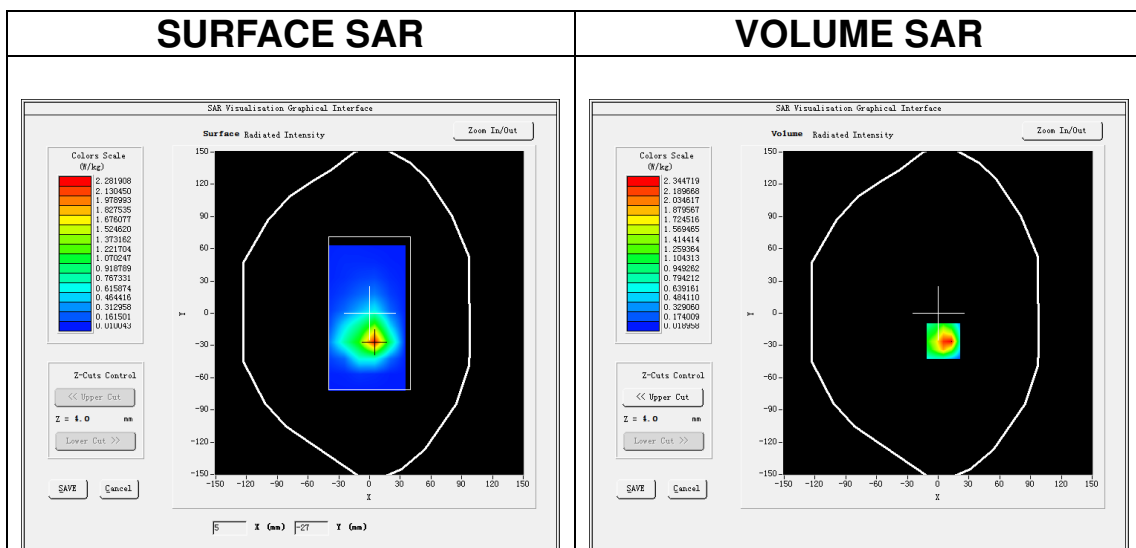

Maximum location: X=5.00, Y=-26.00
SAR Peak: 4.79 W/kg

SAR 10g (W/Kg)	0.930343
SAR 1g (W/Kg)	2.274664

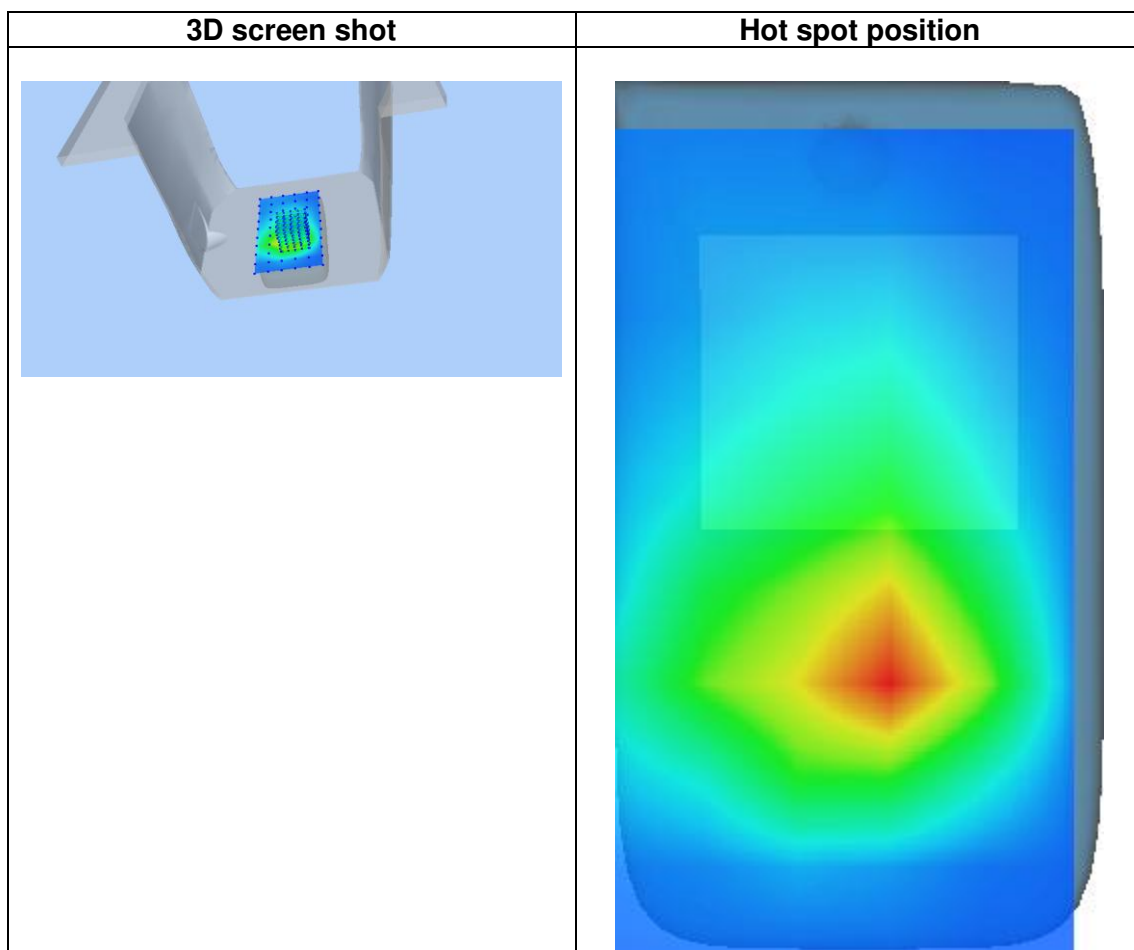
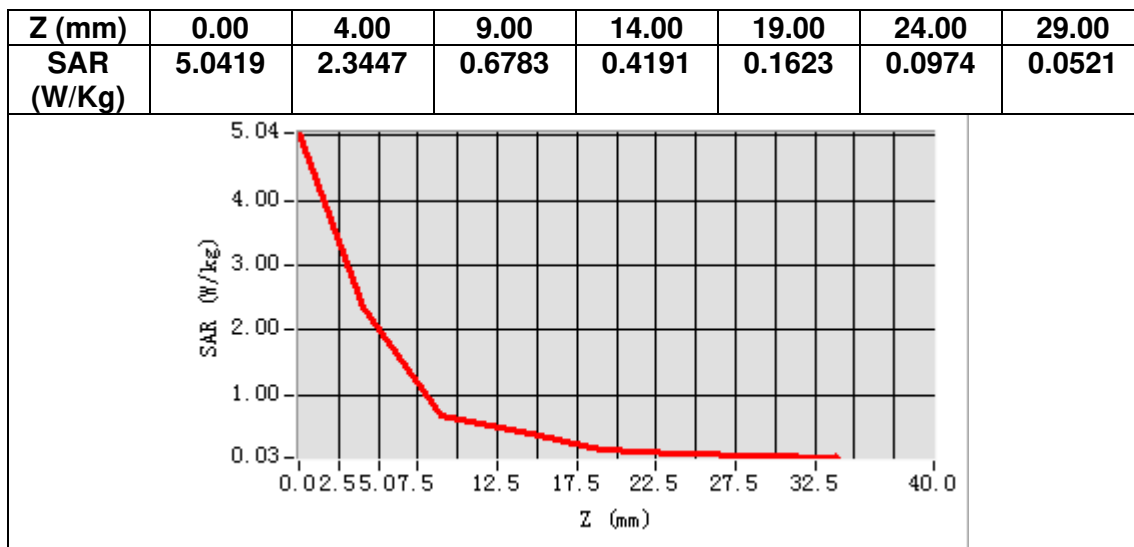

MEASUREMENT 7

Date of measurement: 7/11/2022

A. Experimental conditions.

Area Scan	<u>dx=15mm dy=15mm, h= 5.00 mm</u>
ZoomScan	<u>5x5x7,dx=8mm dy=8mm dz=5mm</u>
Phantom	<u>Left head</u>
Device Position	<u>Cheek</u>
Band	<u>Band8 WCDMA900</u>
Channels	<u>Middle</u>
Signal	<u>WCDMA (Crest factor: 1.0)</u>
ConvF	<u>1.61</u>

B. SAR Measurement Results

Frequency (MHz)	897.600000
Relative permittivity (real part)	39.936111
Relative permittivity (imaginary part)	19.493231
Conductivity (S/m)	0.972062
Variation (%)	1.580000

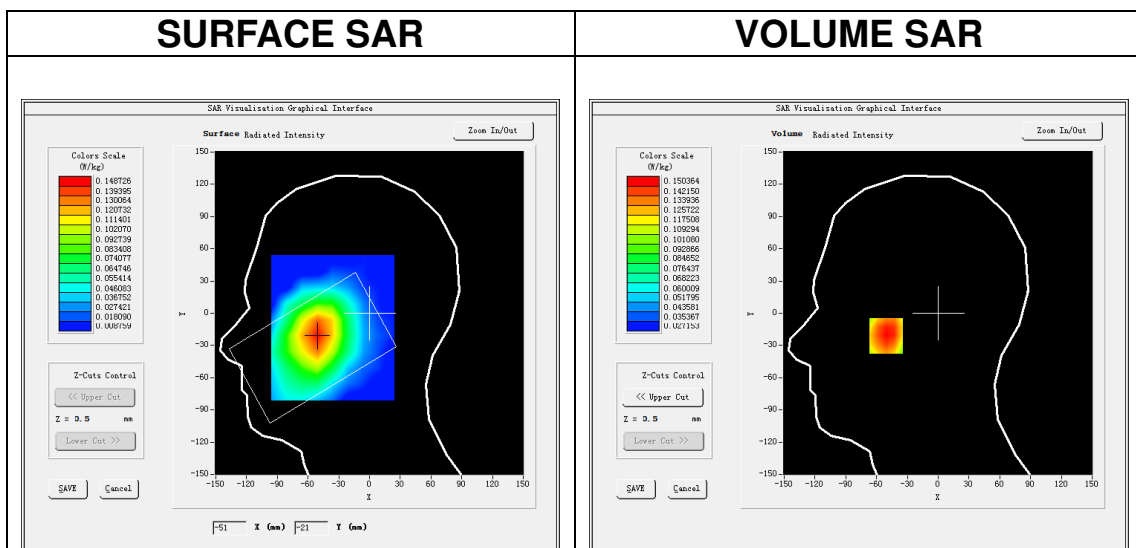

Maximum location: X=-51.00, Y=-21.00
SAR Peak: 0.18 W/kg

SAR 10g (W/Kg)	0.113628
SAR 1g (W/Kg)	0.148144

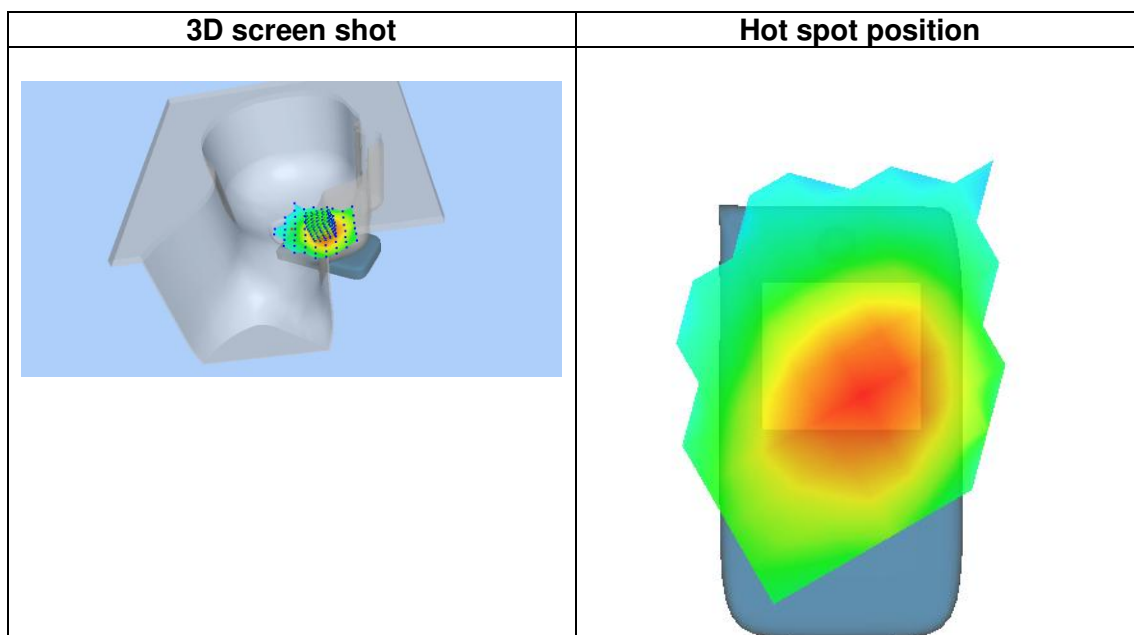
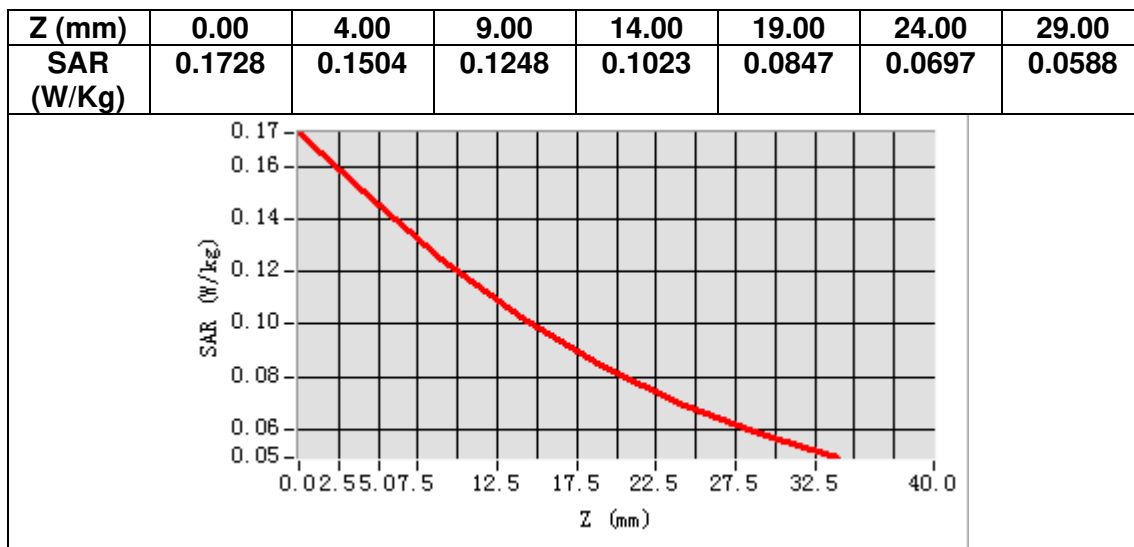

MEASUREMENT 8

Date of measurement: 7/11/2022

A. Experimental conditions.

Area Scan	<u>dx=15mm dy=15mm, h= 5.00 mm</u>
ZoomScan	<u>5x5x7, dx=8mm dy=8mm dz=5mm</u>
Phantom	<u>Validation plane</u>
Device Position	<u>Body</u>
Band	<u>Band8 WCDMA900</u>
Channels	<u>Middle</u>
Signal	<u>WCDMA (Crest factor: 1.0)</u>
ConvF	<u>1.61</u>

B. SAR Measurement Results

Frequency (MHz)	897.600000
Relative permittivity (real part)	39.936111
Relative permittivity (imaginary part)	19.493231
Conductivity (S/m)	0.972062
Variation (%)	0.250000

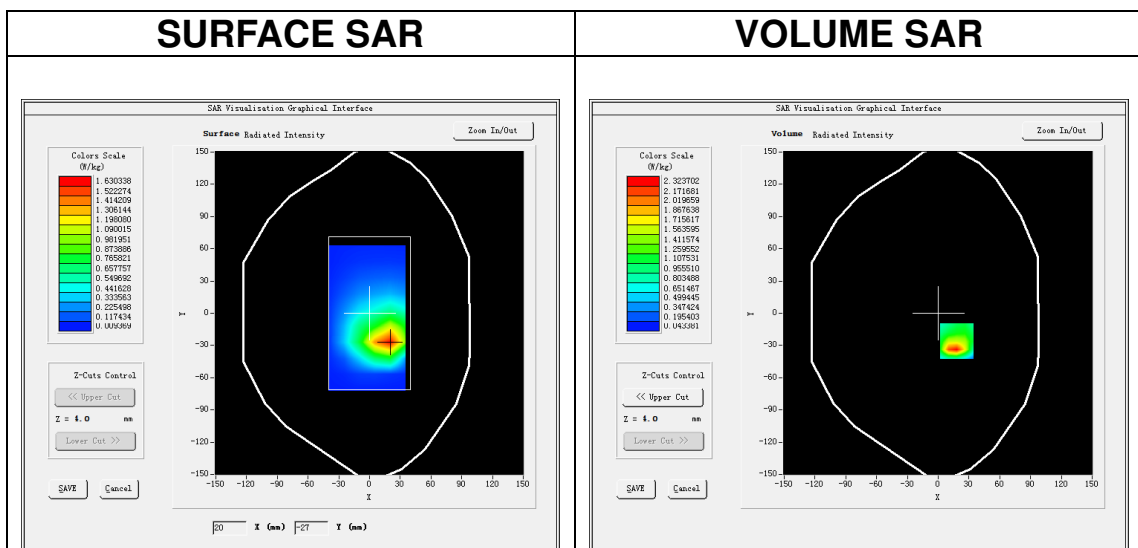

Maximum location: X=18.00, Y=-26.00
SAR Peak: 4.41 W/kg

SAR 10g (W/Kg)	0.964645
SAR 1g (W/Kg)	2.171164

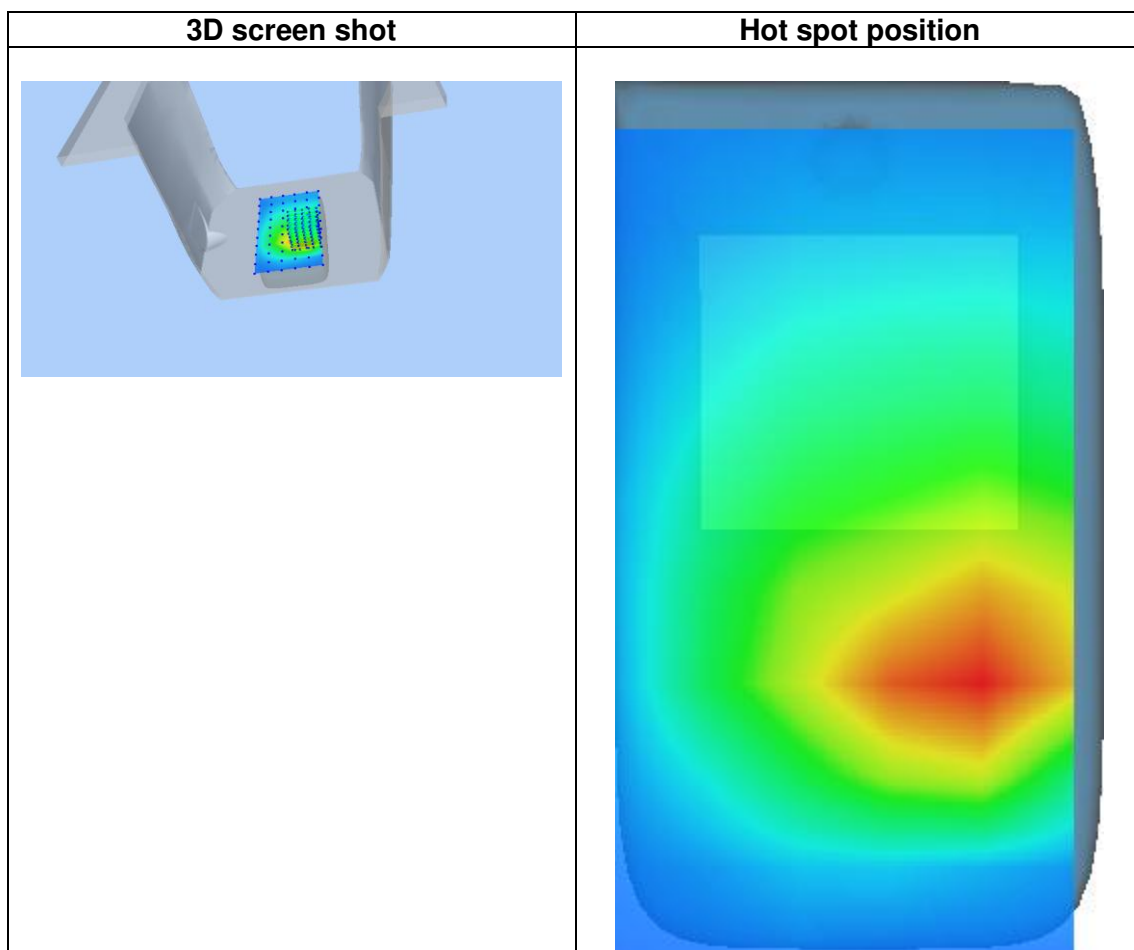
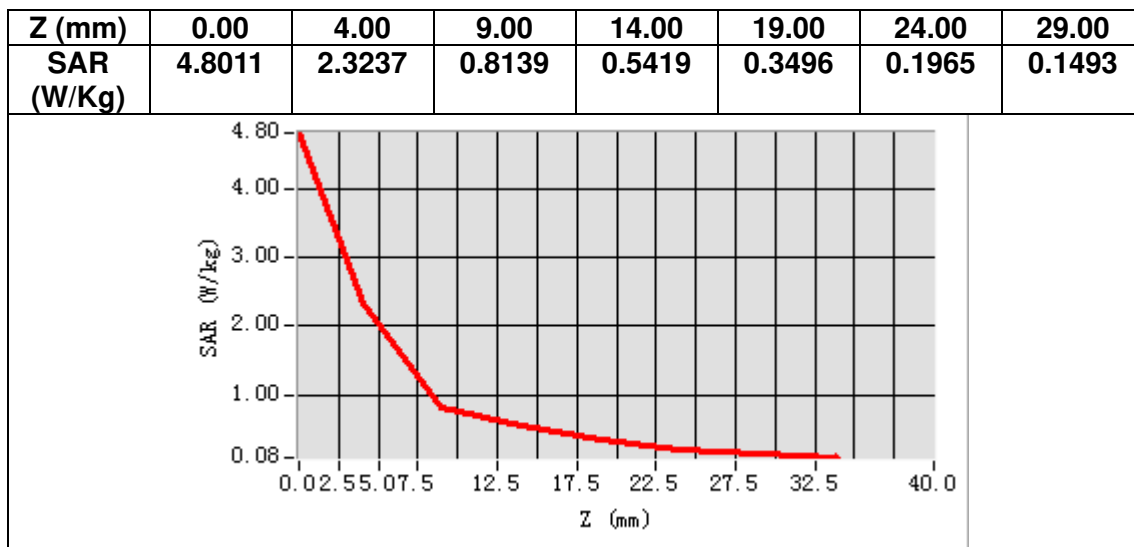

MEASUREMENT 9

Date of measurement: 4/11/2022

A. Experimental conditions.

Area Scan	<u>dx=10mm dy=10mm, h= 2.00 mm</u>
ZoomScan	<u>7x7x12,dx=4mm dy=4mm dz=2mm</u>
Phantom	<u>Left head</u>
Device Position	<u>Cheek</u>
Band	<u>IEEE 802.11n U-NII</u>
Channels	<u>Middle</u>
Signal	<u>IEEE802.11n (Crest factor: 1.0)</u>
ConvF	<u>1.80</u>

B. SAR Measurement Results

Frequency (MHz)	5190.000000
Relative permittivity (real part)	35.421220
Relative permittivity (imaginary part)	15.963946
Conductivity (S/m)	4.602938
Variation (%)	0.300000

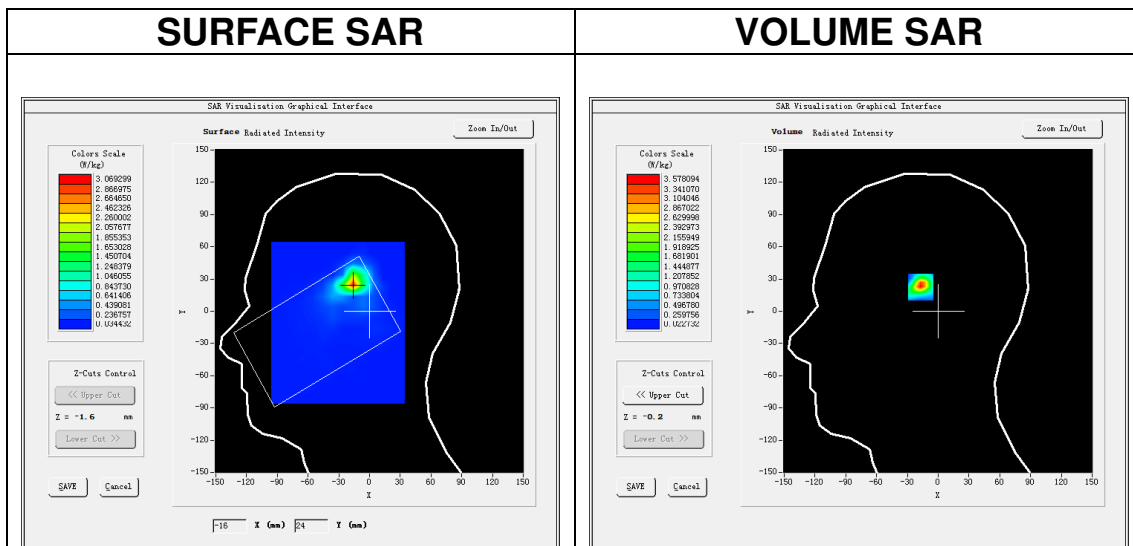

Maximum location: X=-16.00, Y=26.00
SAR Peak: 10.10 W/kg

SAR 10g (W/Kg)	0.901575
SAR 1g (W/Kg)	3.241798

Z (m)	0.00	2.00	4.00	6.00	8.00	10.0	12.0	14.0	16.0	18.0	20.0	22.0
SAR (W/Kg)	6.1959	3.5781	1.6533	0.8438	0.4181	0.2102	0.1398	0.0841	0.0632	0.0497	0.0405	0.0420

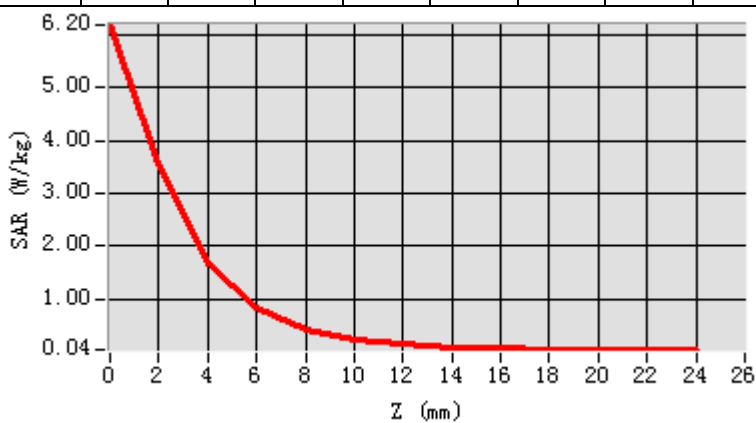

3D screen shot

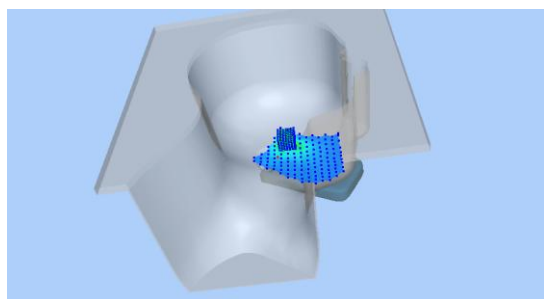

Hot spot position

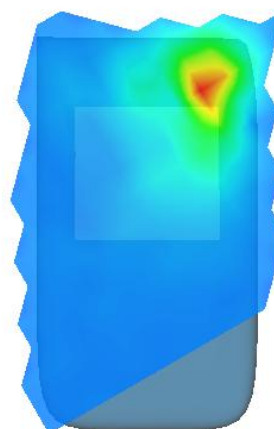

MEASUREMENT 10

Date of measurement: 5/11/2022

A. Experimental conditions.

Area Scan	<u>dx=10mm dy=10mm, h= 2.00 mm</u>
ZoomScan	<u>7x7x12,dx=4mm dy=4mm dz=2mm</u>
Phantom	<u>Left head</u>
Device Position	<u>Cheek</u>
Band	<u>IEEE 802.11a U-NII</u>
Channels	<u>Middle</u>
Signal	<u>IEEE802.11a (Crest factor: 1.0)</u>
ConvF	<u>2.07</u>

B. SAR Measurement Results

Frequency (MHz)	5785.000000
Relative permittivity (real part)	34.159088
Relative permittivity (imaginary part)	15.654541
Conductivity (S/m)	5.031196
Variation (%)	-2.140000

SURFACE SAR

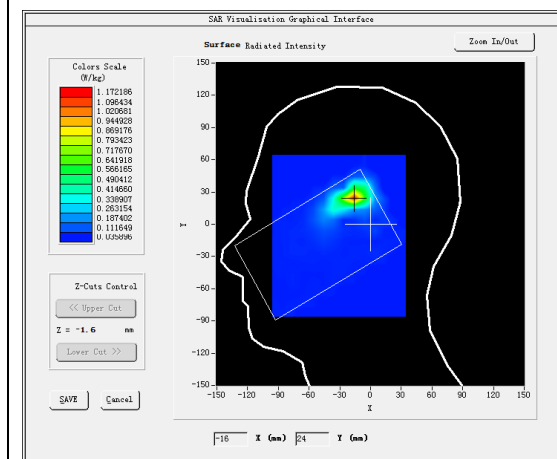

VOLUME SAR

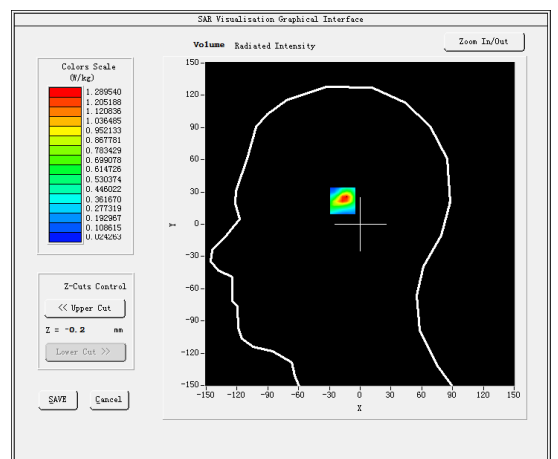

Maximum location: X=-16.00, Y=25.00
SAR Peak: 3.80 W/kg

SAR 10g (W/Kg)	0.372264
SAR 1g (W/Kg)	1.244617

Z (m m)	0.00	2.00	4.00	6.00	8.00	10.00	12.00	14.00	16.00	18.00	20.00	22.00
SAR (W/Kg)	2.3208	1.2895	0.3660	0.2752	0.1235	0.0878	0.0474	0.0464	0.0398	0.0460	0.0430	0.0396

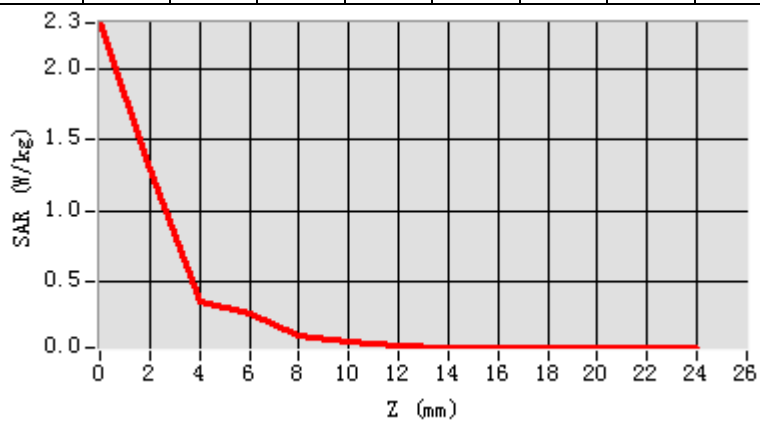

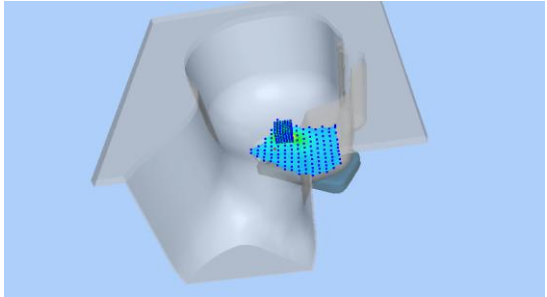
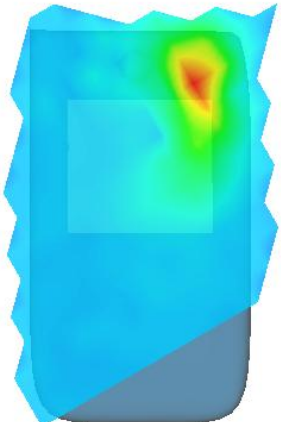
3D screen shot	Hot spot position
	

MEASUREMENT 11

Date of measurement: 4/11/2022

A. Experimental conditions.

Area Scan	<u>dx=10mm dy=10mm, h= 2.00 mm</u>
ZoomScan	<u>7x7x12,dx=4mm dy=4mm dz=2mm</u>
Phantom	<u>Validation plane</u>
Device Position	<u>Body</u>
Band	<u>IEEE 802.11n U-NII</u>
Channels	<u>Middle</u>
Signal	<u>IEEE802.11n (Crest factor: 1.0)</u>
ConvF	<u>1.80</u>

B. SAR Measurement Results

Frequency (MHz)	5190.000000
Relative permittivity (real part)	35.421220
Relative permittivity (imaginary part)	15.963946
Conductivity (S/m)	4.602938
Variation (%)	-0.490000

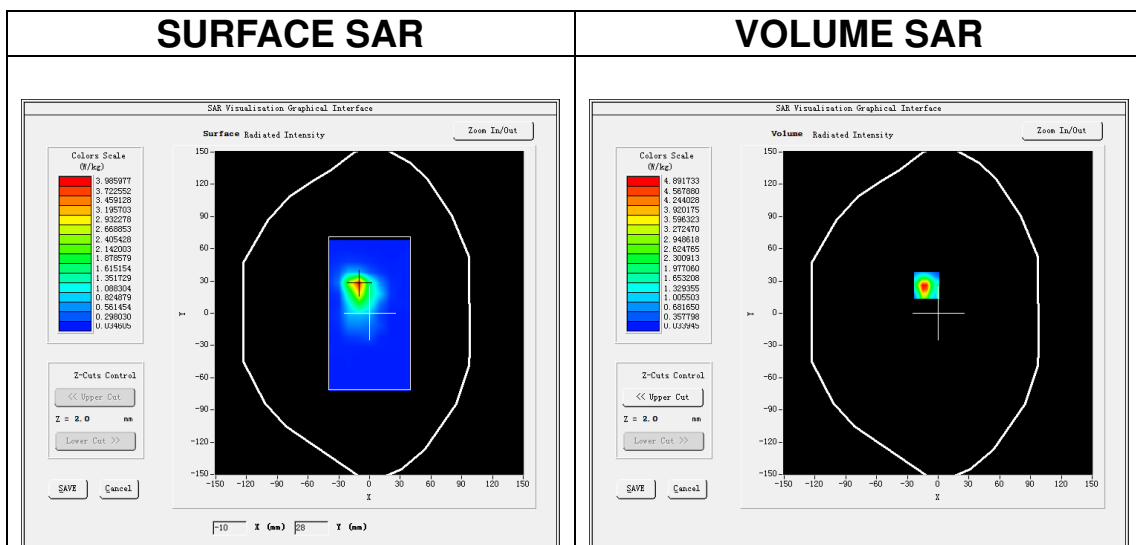

Maximum location: X=-11.00, Y=26.00
SAR Peak: 9.42 W/kg

SAR 10g (W/Kg)	0.754756
SAR 1g (W/Kg)	2.572497

Z (m m)	0.00	2.00	4.00	6.00	8.00	10.0	12.0	14.0	16.0	18.0	20.0	22.0
SAR (W/Kg)	8.7719	4.8917	1.4006	1.1490	0.3115	0.3009	0.1157	0.1023	0.0480	0.0494	0.0418	0.0368

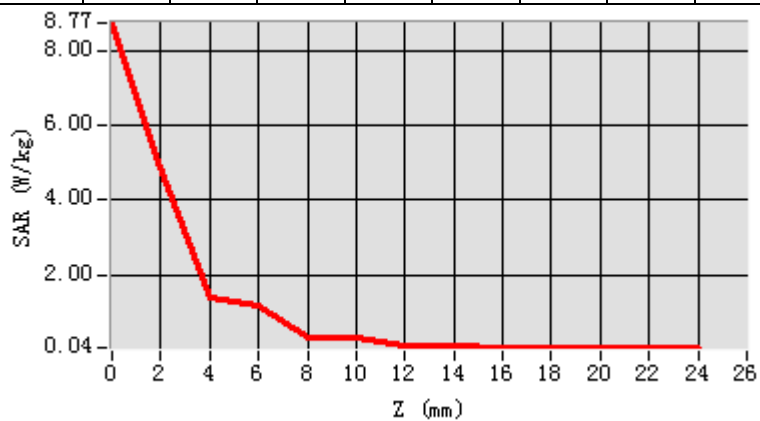

3D screen shot

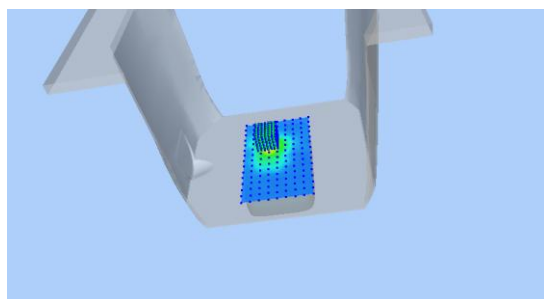

Hot spot position

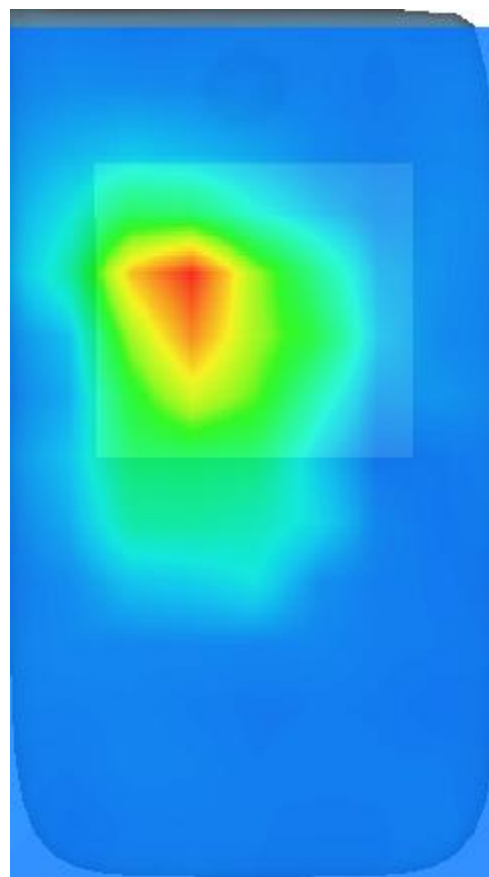

MEASUREMENT 12

Date of measurement: 5/11/2022

A. Experimental conditions.

Area Scan	<u>dx=10mm dy=10mm, h= 2.00 mm</u>
ZoomScan	<u>7x7x12,dx=4mm dy=4mm dz=2mm</u>
Phantom	<u>Validation plane</u>
Device Position	<u>Body</u>
Band	<u>IEEE 802.11a U-NII</u>
Channels	<u>Middle</u>
Signal	<u>IEEE802.11a (Crest factor: 1.0)</u>
ConvF	<u>2.07</u>

B. SAR Measurement Results

Frequency (MHz)	5785.000000
Relative permittivity (real part)	34.159088
Relative permittivity (imaginary part)	15.654541
Conductivity (S/m)	5.031196
Variation (%)	0.940000

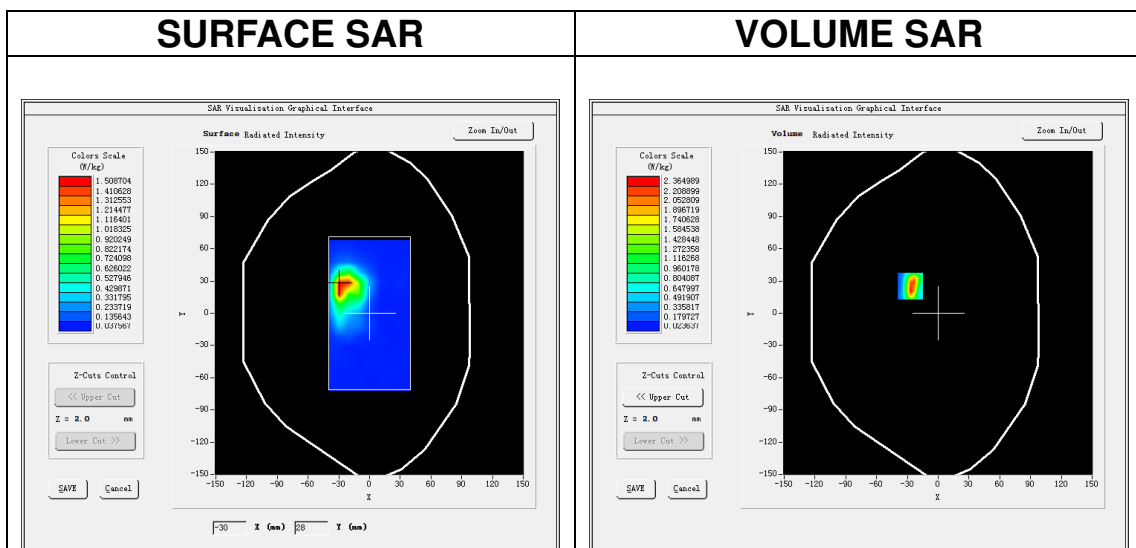

Maximum location: X=-27.00, Y=25.00
SAR Peak: 4.57 W/kg

SAR 10g (W/Kg)	0.386906
SAR 1g (W/Kg)	1.189777

Z (m m)	0.00	2.00	4.00	6.00	8.00	10.0	12.0	14.0	16.0	18.0	20.0	22.0
SAR (W/Kg)	4.2486	2.3650	0.9348	0.4590	0.2037	0.1183	0.0739	0.0515	0.0410	0.0438	0.0402	0.0368

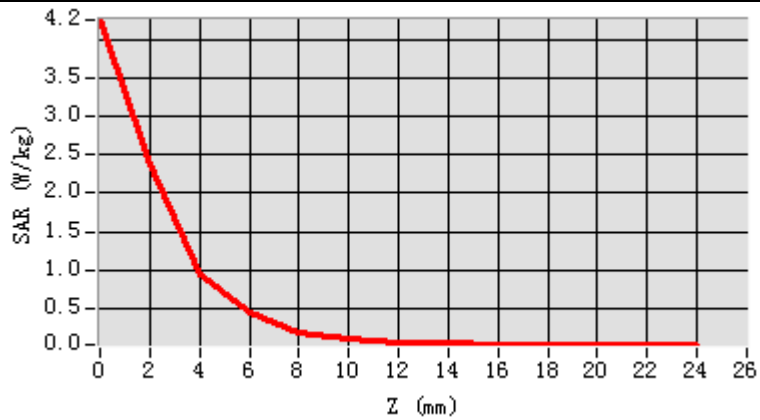

3D screen shot

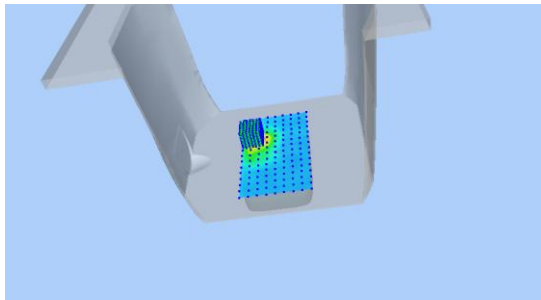

Hot spot position

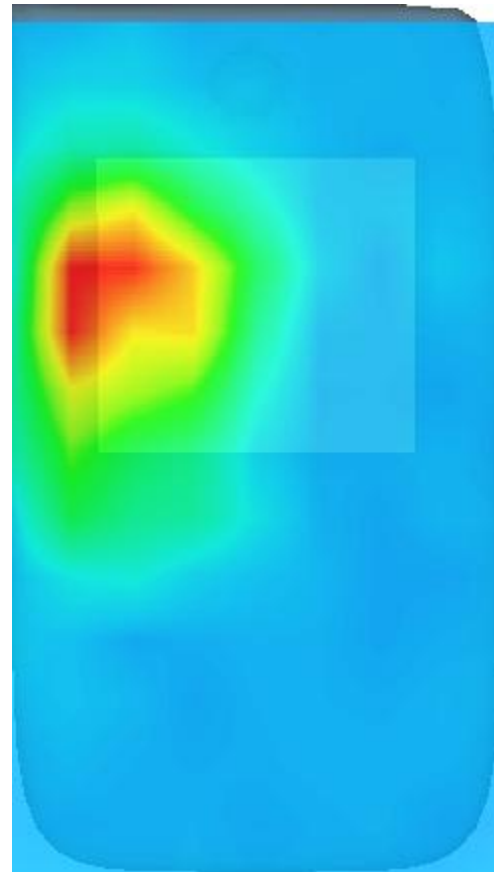

MEASUREMENT 13

Date of measurement: 1/11/2022

A. Experimental conditions.

Area Scan	<u>dx=12mm dy=12mm, h= 5.00 mm</u>
ZoomScan	<u>7x7x7,dx=5mm dy=5mm dz=5mm</u>
Phantom	<u>Left head</u>
Device Position	<u>Cheek</u>
Band	<u>IEEE 802.11b ISM</u>
Channels	<u>Middle</u>
Signal	<u>IEEE802.11b (Crest factor: 1.0)</u>
ConvF	<u>1.98</u>

B. SAR Measurement Results

Frequency (MHz)	2442.000000
Relative permittivity (real part)	37.643295
Relative permittivity (imaginary part)	13.001927
Conductivity (S/m)	1.763928
Variation (%)	-2.600000

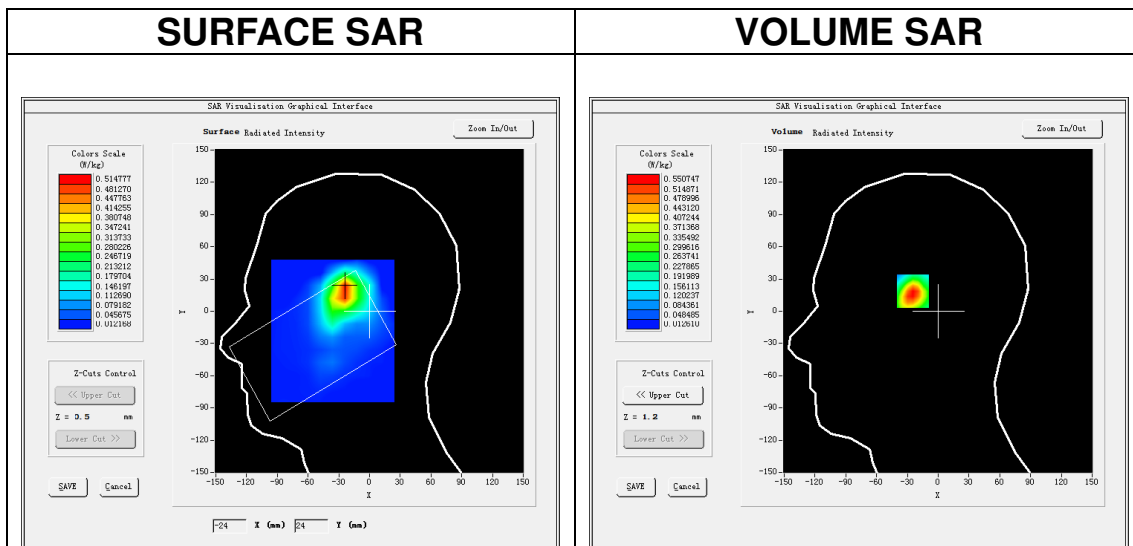

Maximum location: X=-24.00, Y=21.00
SAR Peak: 0.91 W/kg

SAR 10g (W/Kg)	0.257190
SAR 1g (W/Kg)	0.514608

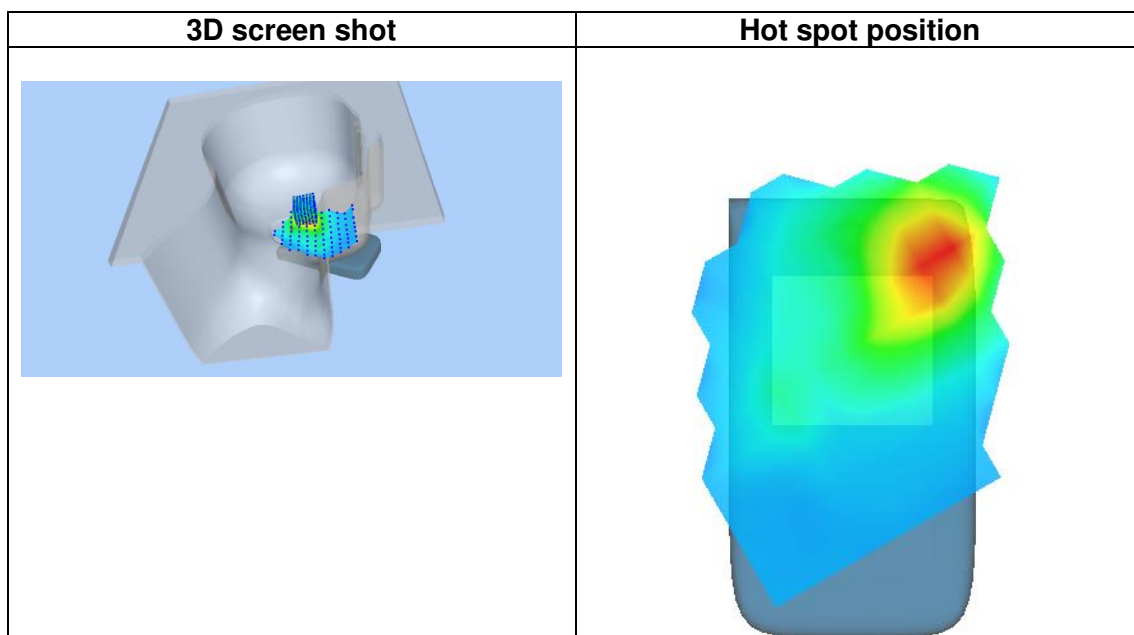
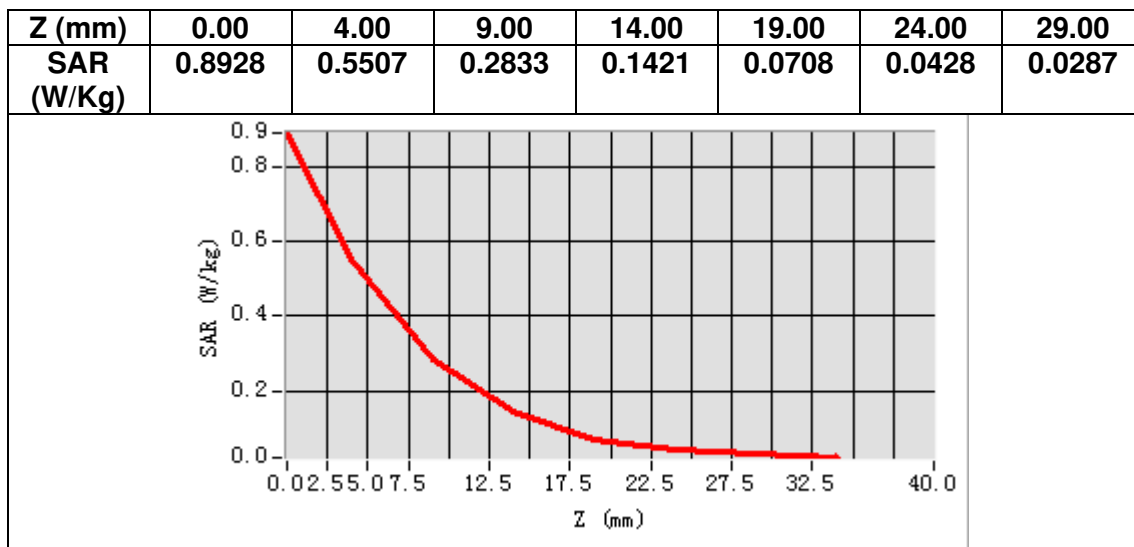

MEASUREMENT 14

Date of measurement: 1/11/2022

A. Experimental conditions.

Area Scan	<u>dx=12mm dy=12mm, h= 5.00 mm</u>
ZoomScan	<u>7x7x7,dx=5mm dy=5mm dz=5mm</u>
Phantom	<u>Validation plane</u>
Device Position	<u>Body</u>
Band	<u>IEEE 802.11b ISM</u>
Channels	<u>Middle</u>
Signal	<u>IEEE802.11b (Crest factor: 1.0)</u>
ConvF	<u>1.98</u>

B. SAR Measurement Results

Frequency (MHz)	2442.000000
Relative permittivity (real part)	37.643295
Relative permittivity (imaginary part)	13.001927
Conductivity (S/m)	1.763928
Variation (%)	-0.440000

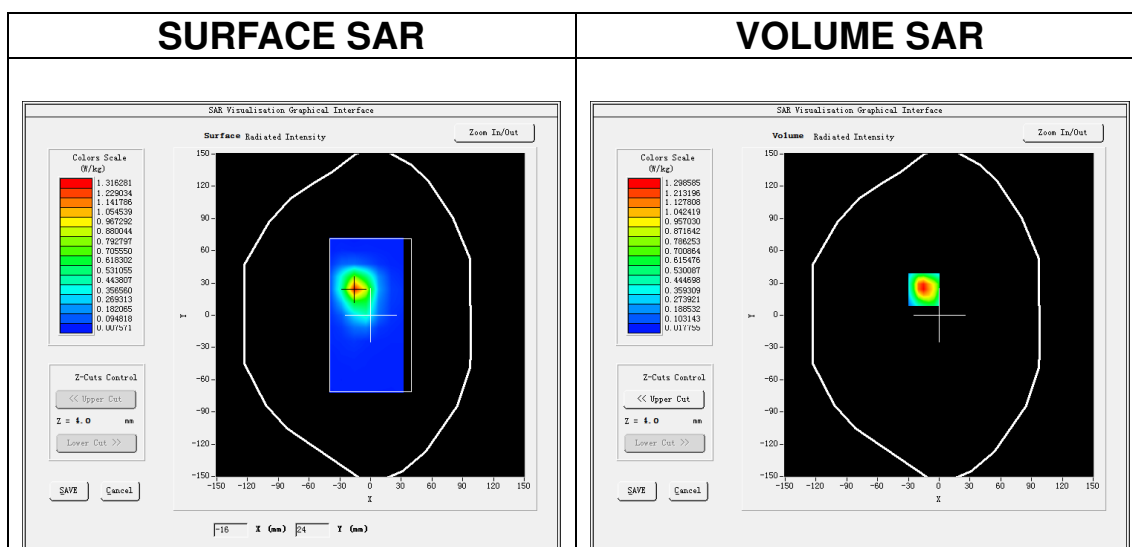

Maximum location: X=-15.00, Y=24.00
SAR Peak: 2.39 W/kg

SAR 10g (W/Kg)	0.529388
SAR 1g (W/Kg)	1.209594

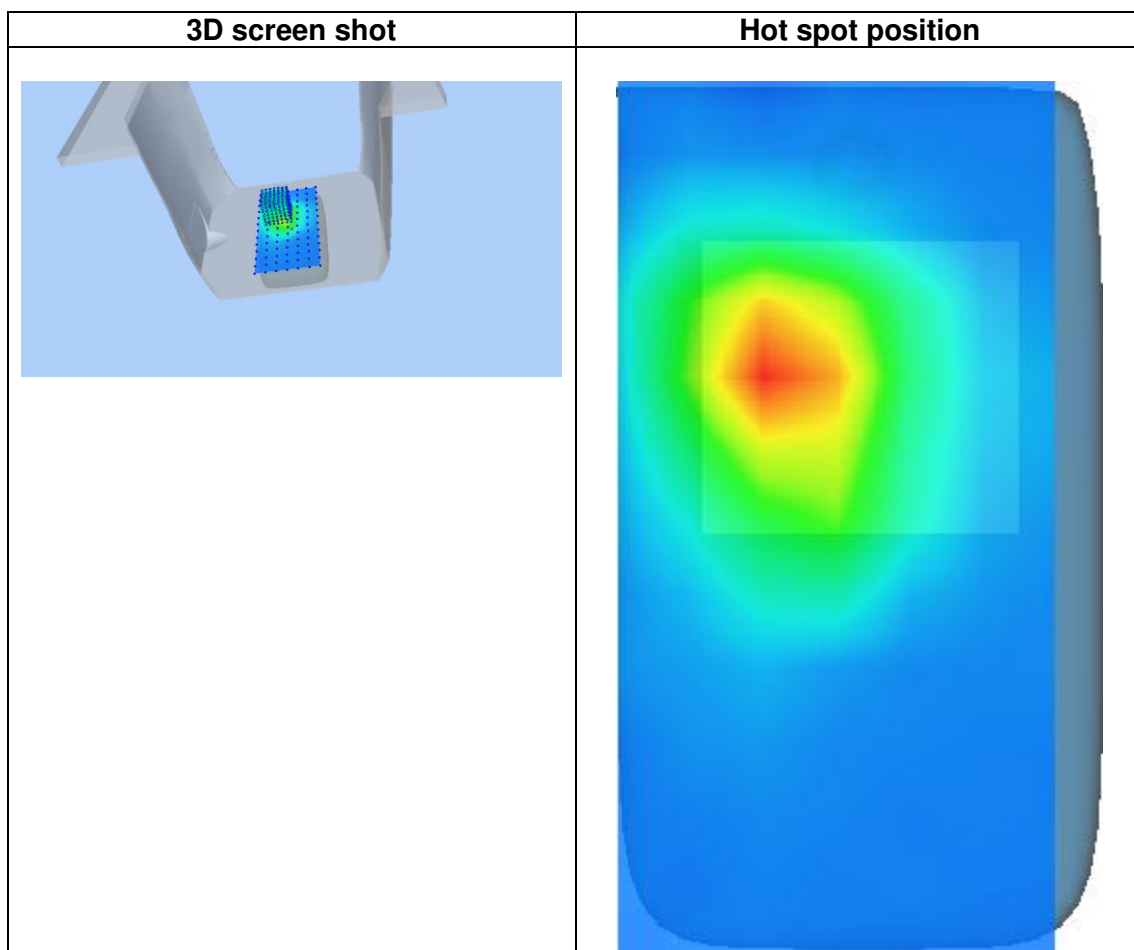
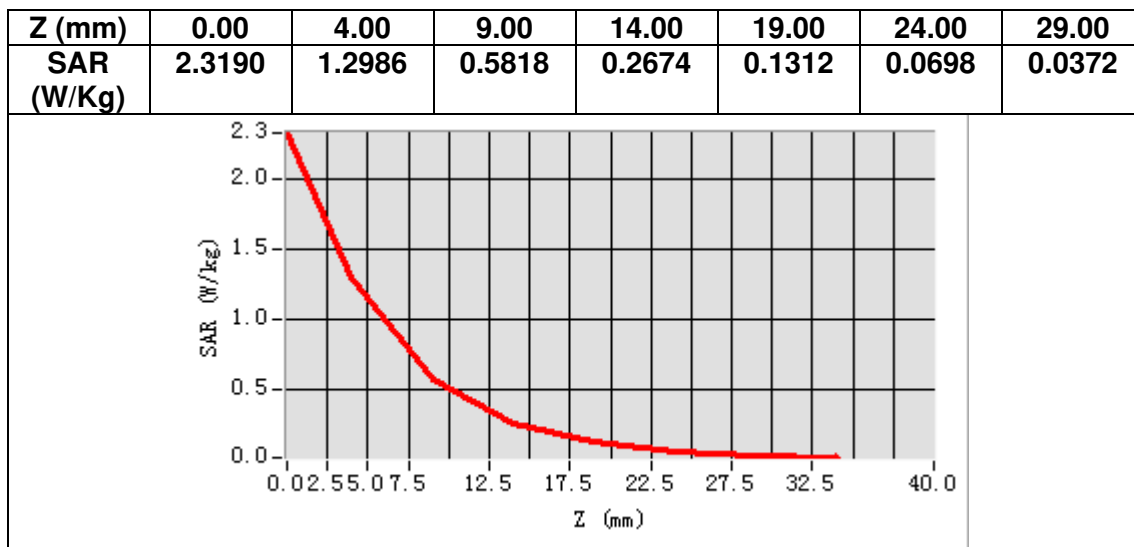

MEASUREMENT 15

Date of measurement: 8/11/2022

A. Experimental conditions.

Area Scan	<u>dx=15mm dy=15mm, h= 5.00 mm</u>
ZoomScan	<u>5x5x7,dx=8mm dy=8mm dz=5mm</u>
Phantom	<u>Left head</u>
Device Position	<u>Cheek</u>
Band	<u>LTE band 1</u>
Channels	<u>Middle</u>
Signal	<u>LTE (Crest factor: 1.0)</u>
ConvF	<u>1.97</u>

B. SAR Measurement Results

Frequency (MHz)	1950.000000
Relative permittivity (real part)	39.412312
Relative permittivity (imaginary part)	12.581021
Conductivity (S/m)	1.362944
Variation (%)	1.770000

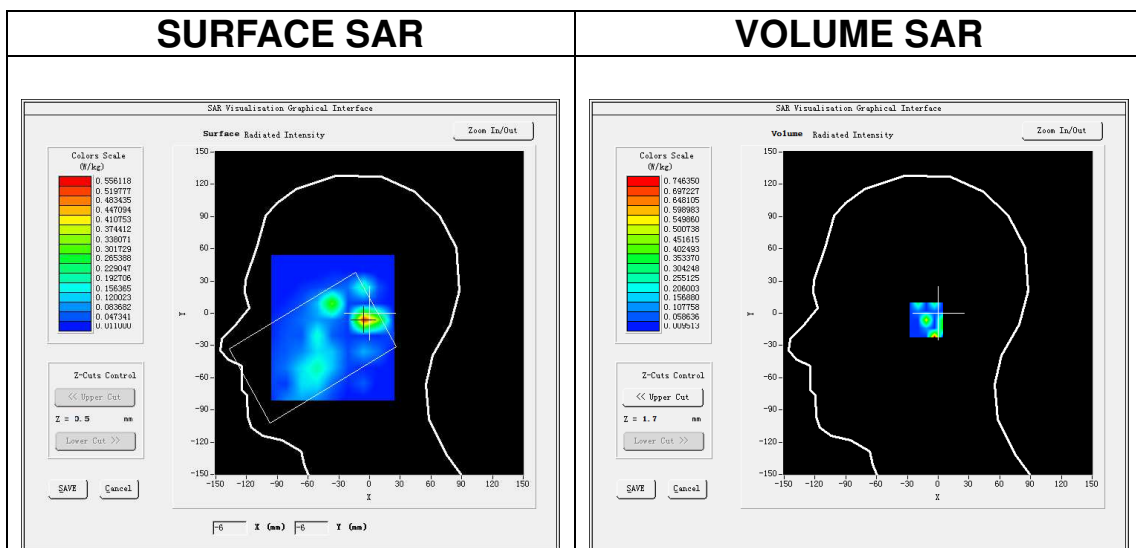

Maximum location: X=-5.00, Y=-6.00
SAR Peak: 2.02 W/kg

SAR 10g (W/Kg)	0.159484
SAR 1g (W/Kg)	0.351488

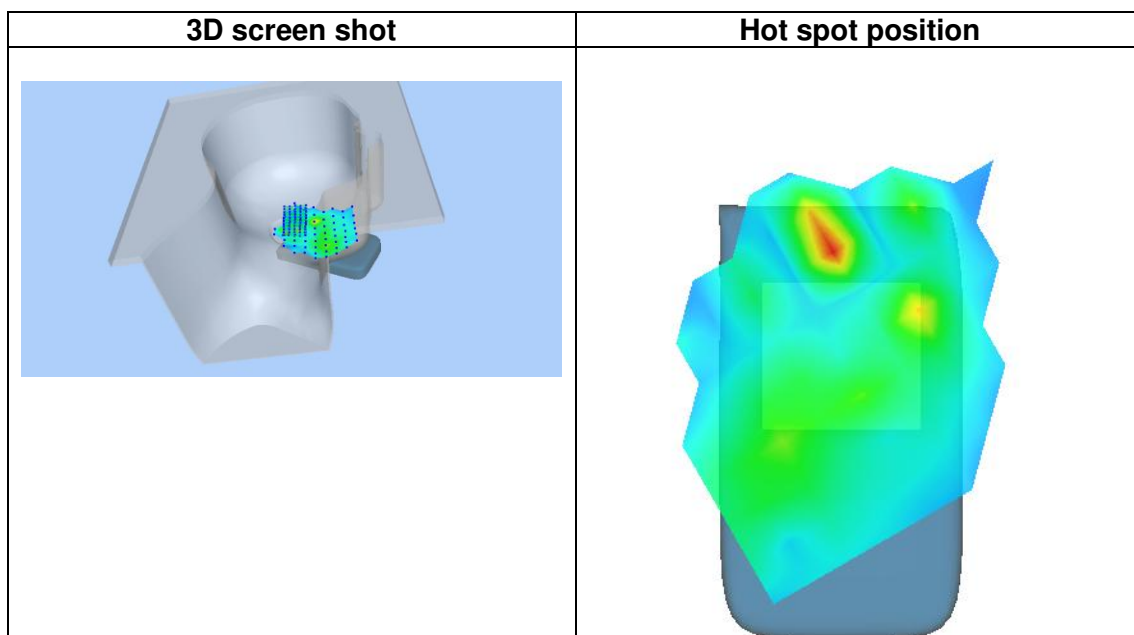
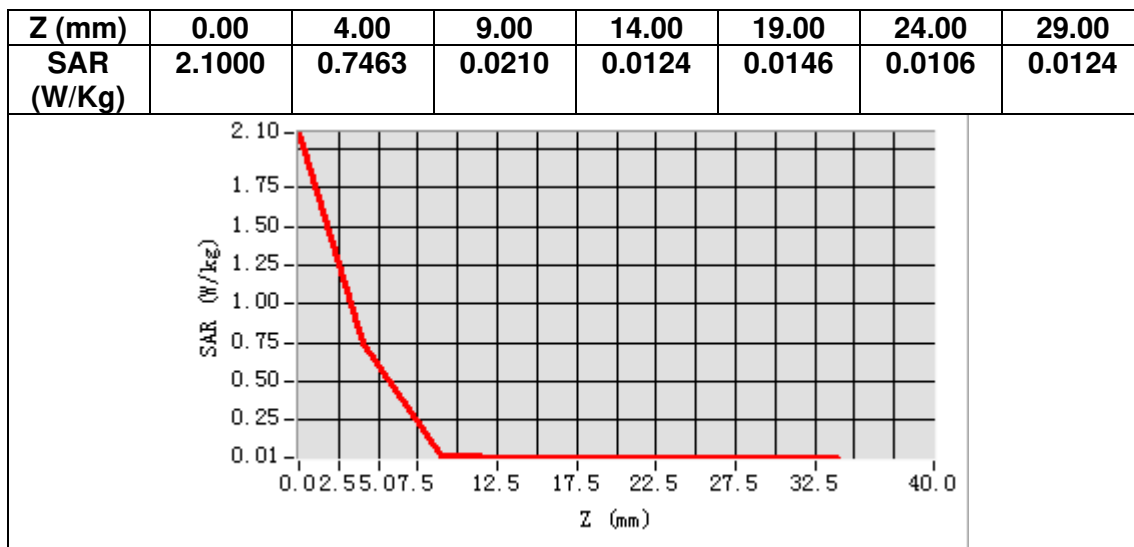

MEASUREMENT 16

Date of measurement: 8/11/2022

A. Experimental conditions.

Area Scan	<u>dx=15mm dy=15mm, h= 5.00 mm</u>
ZoomScan	<u>5x5x7, dx=8mm dy=8mm dz=5mm</u>
Phantom	<u>Validation plane</u>
Device Position	<u>Body</u>
Band	<u>LTE band 1</u>
Channels	<u>Middle</u>
Signal	<u>LTE (Crest factor: 1.0)</u>
ConvF	<u>1.97</u>

B. SAR Measurement Results

Frequency (MHz)	1950.000000
Relative permittivity (real part)	39.412312
Relative permittivity (imaginary part)	12.581021
Conductivity (S/m)	1.362944
Variation (%)	4.680000

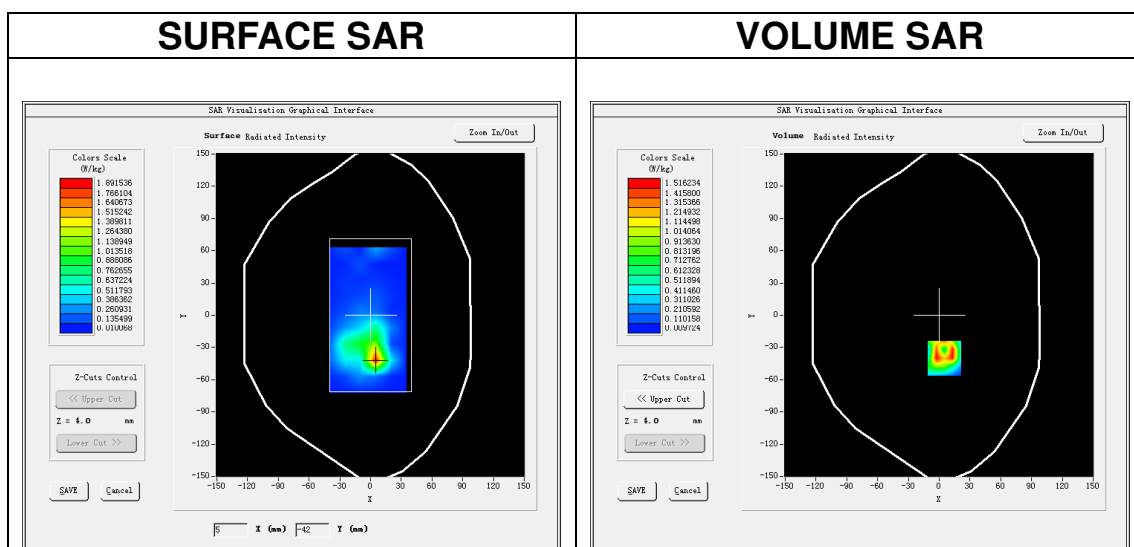

Maximum location: X=5.00, Y=-40.00
SAR Peak: 2.92 W/kg

SAR 10g (W/Kg)	0.591615
SAR 1g (W/Kg)	1.293852

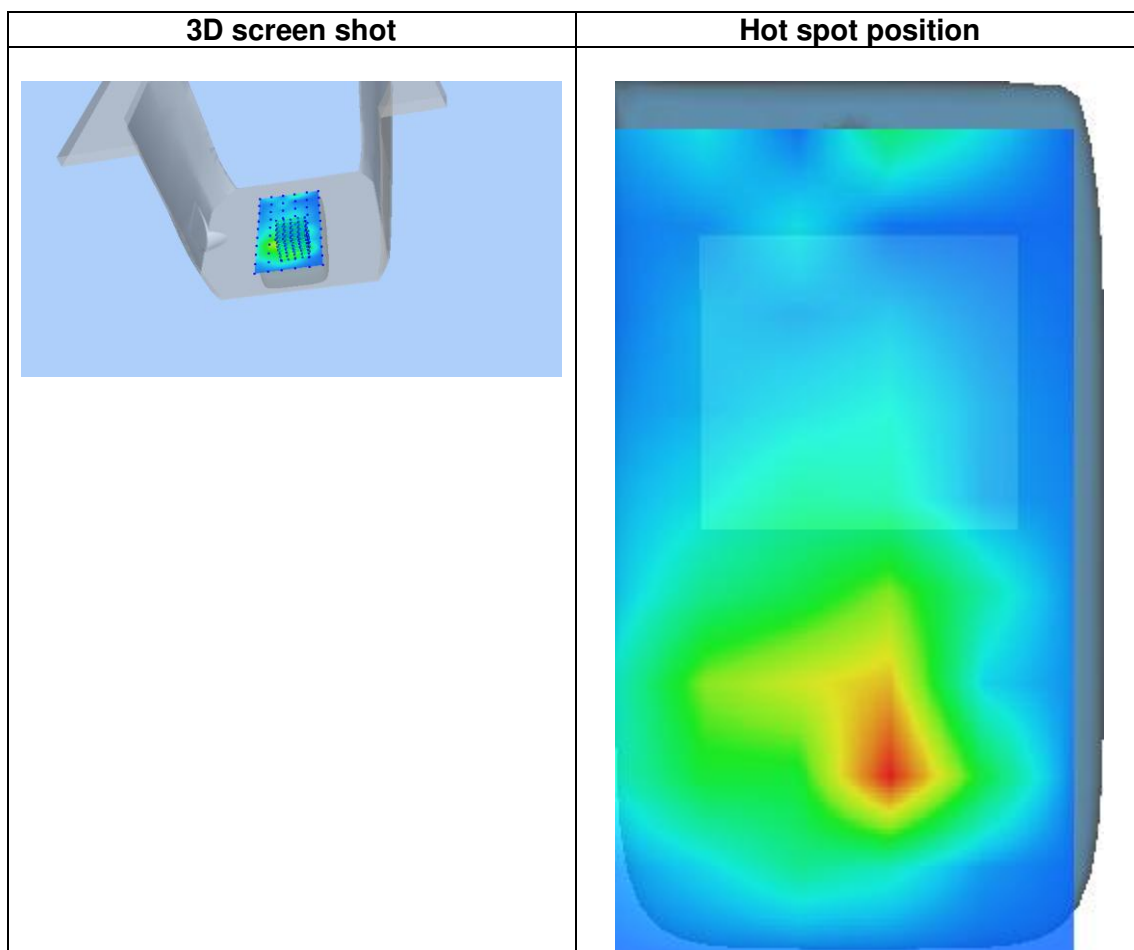
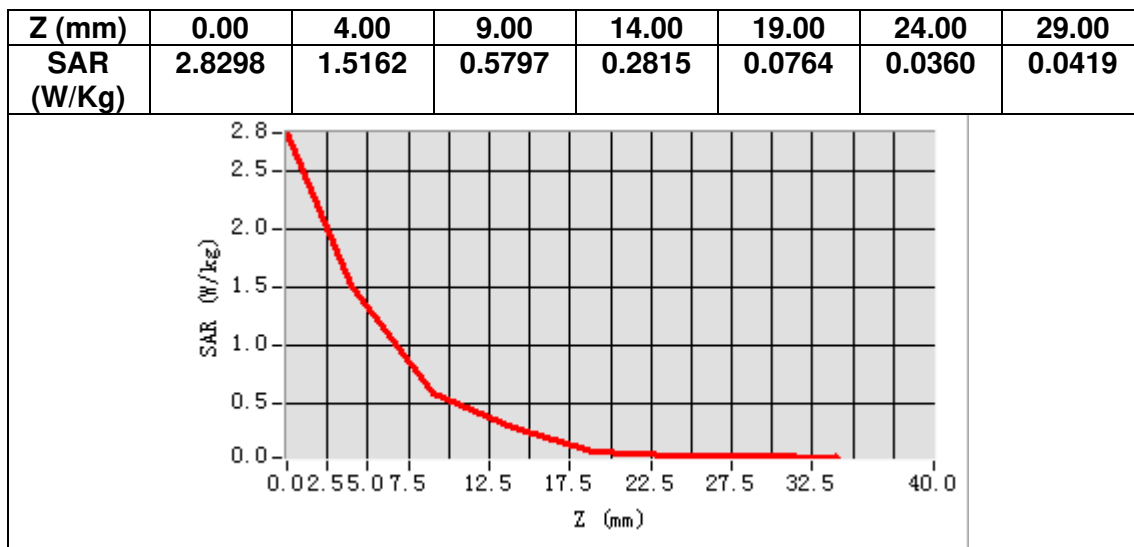

MEASUREMENT 17

Date of measurement: 28/10/2022

A. Experimental conditions.

Area Scan	<u>dx=15mm dy=15mm, h= 5.00 mm</u>
ZoomScan	<u>5x5x7,dx=8mm dy=8mm dz=5mm</u>
Phantom	<u>Left head</u>
Device Position	<u>Cheek</u>
Band	<u>LTE band 3</u>
Channels	<u>Middle</u>
Signal	<u>LTE (Crest factor: 1.0)</u>
ConvF	<u>1.73</u>

B. SAR Measurement Results

Frequency (MHz)	1747.500000
Relative permittivity (real part)	38.975525
Relative permittivity (imaginary part)	13.771164
Conductivity (S/m)	1.336568
Variation (%)	-4.800000

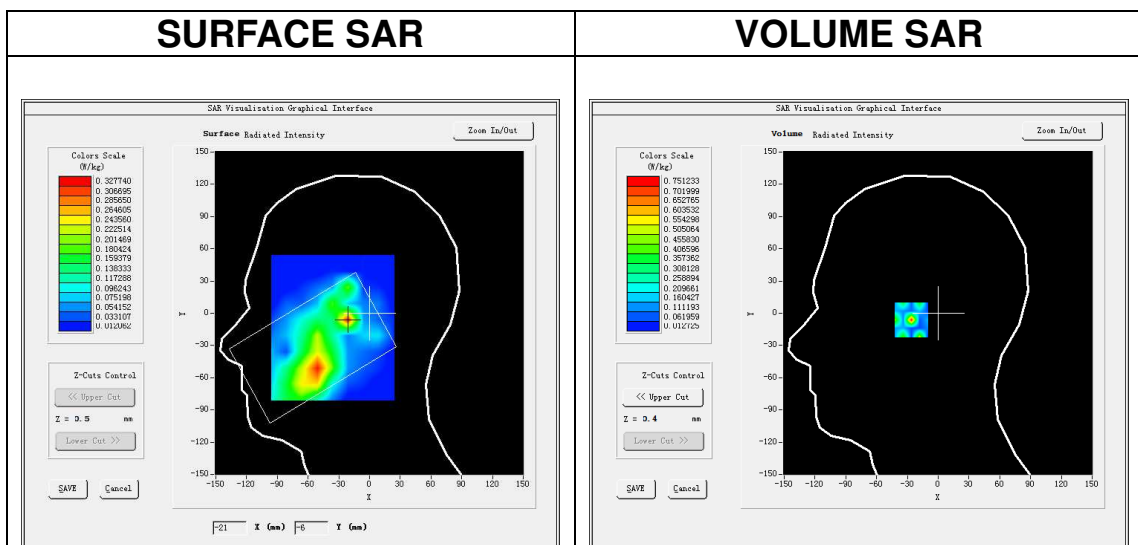

Maximum location: X=-21.00, Y=-6.00
SAR Peak: 1.94 W/kg

SAR 10g (W/Kg)	0.114067
SAR 1g (W/Kg)	0.515640

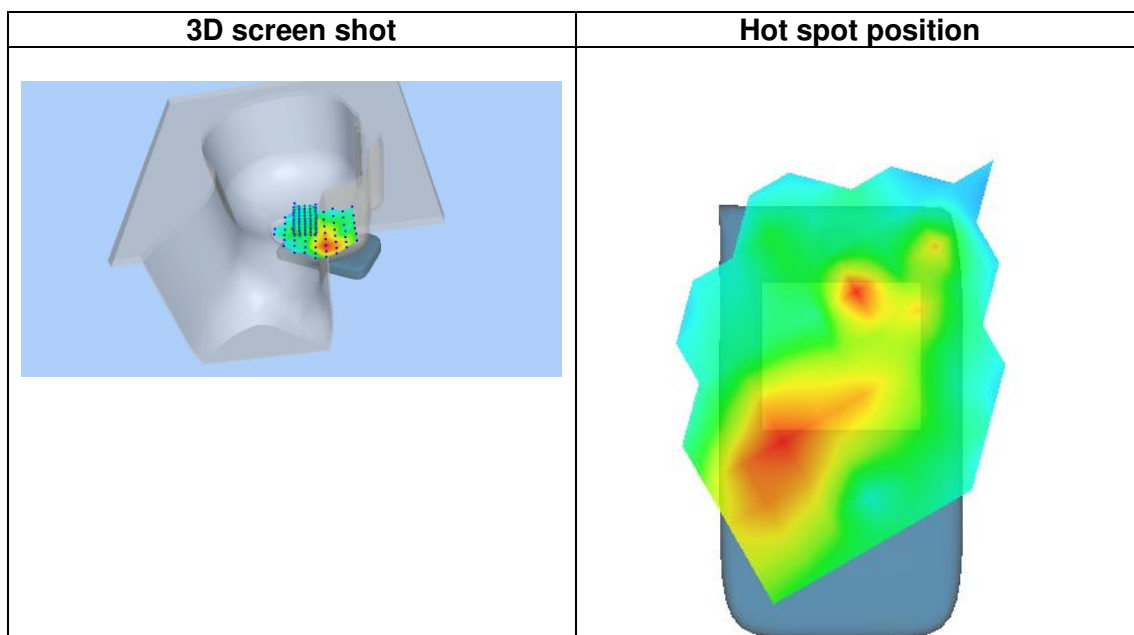
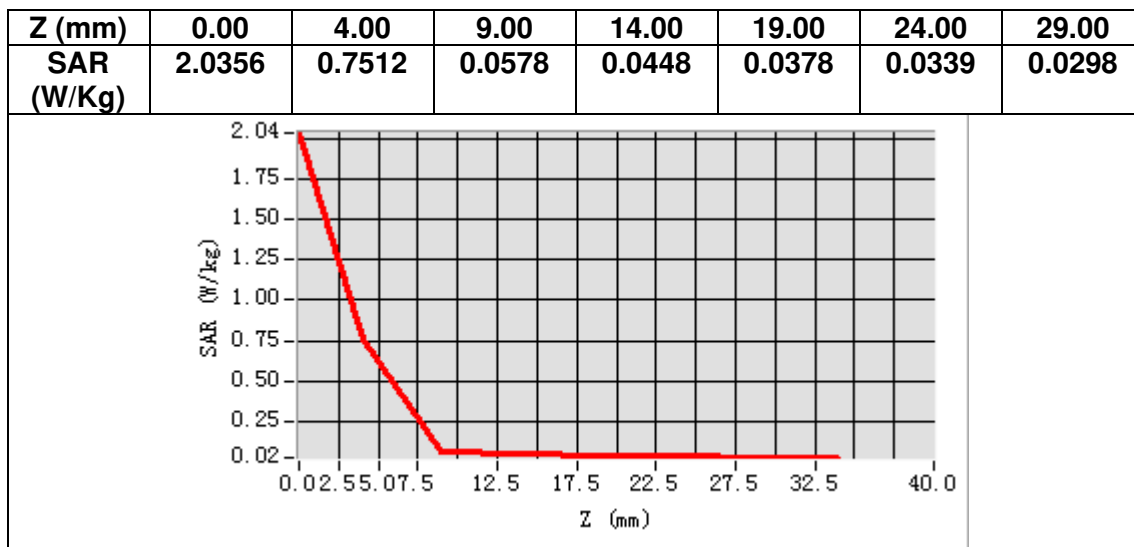

MEASUREMENT 18

Date of measurement: 28/10/2022

A. Experimental conditions.

Area Scan	<u>dx=15mm dy=15mm, h= 5.00 mm</u>
ZoomScan	<u>5x5x7,dx=8mm dy=8mm dz=5mm</u>
Phantom	<u>Validation plane</u>
Device Position	<u>Body</u>
Band	<u>LTE band 3</u>
Channels	<u>Low</u>
Signal	<u>LTE (Crest factor: 1.0)</u>
ConvF	<u>1.73</u>

B. SAR Measurement Results

Frequency (MHz)	1720.000000
Relative permittivity (real part)	39.211624
Relative permittivity (imaginary part)	13.732564
Conductivity (S/m)	1.312223
Variation (%)	-1.230000

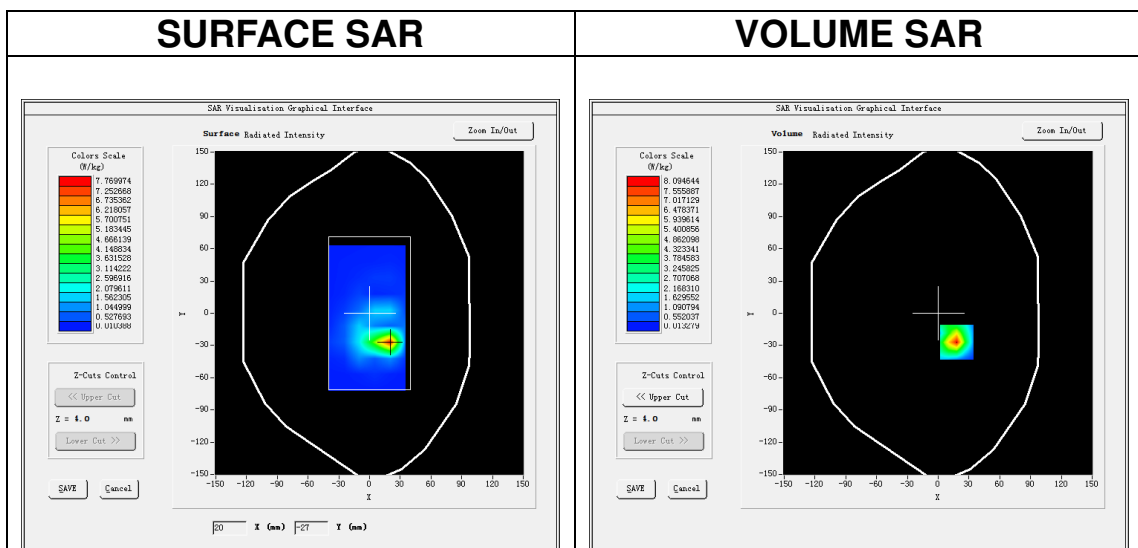

Maximum location: X=18.00, Y=-27.00
SAR Peak: 16.17 W/kg

SAR 10g (W/Kg)	2.669684
SAR 1g (W/Kg)	7.401467

Z (mm)	0.00	4.00	9.00	14.00	19.00	24.00	29.00
SAR (W/Kg)	16.5572	8.0946	2.7628	1.4906	0.7220	0.3686	0.2028

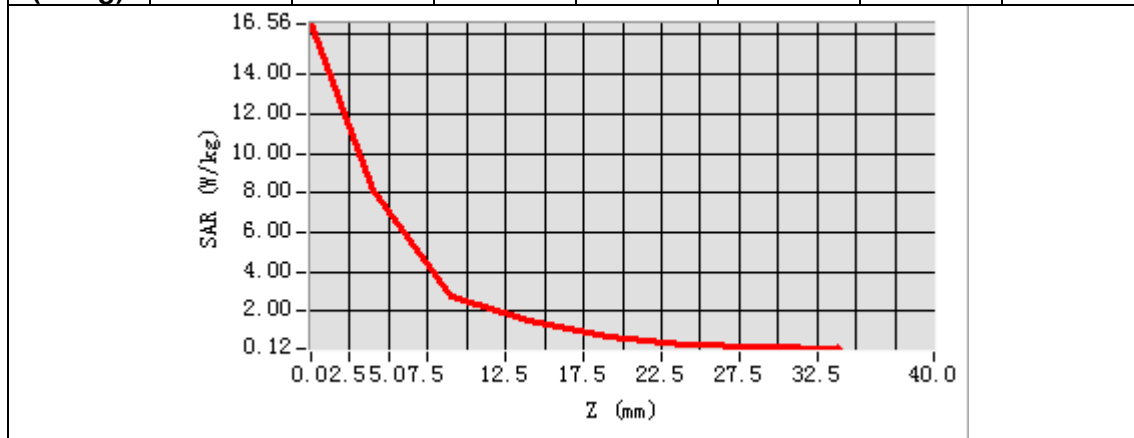

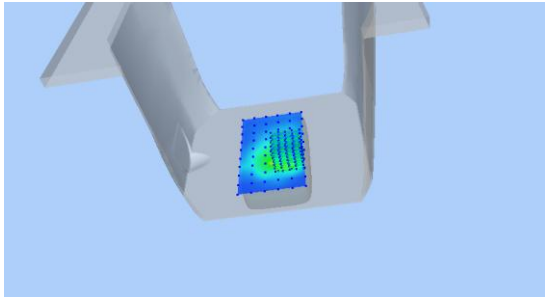
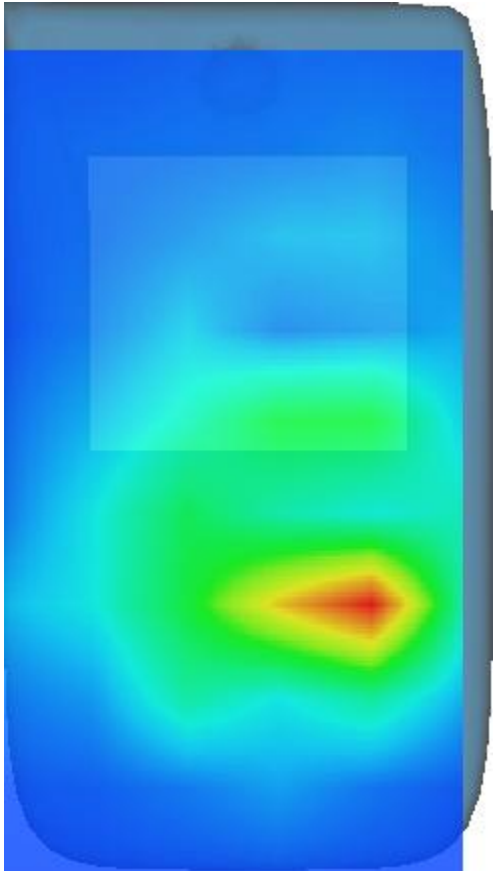
3D screen shot	Hot spot position
	

MEASUREMENT 19

Date of measurement: 10/11/2022

A. Experimental conditions.

Area Scan	<u>dx=12mm dy=12mm, h= 5.00 mm</u>
ZoomScan	<u>7x7x7,dx=5mm dy=5mm dz=5mm</u>
Phantom	<u>Left head</u>
Device Position	<u>Cheek</u>
Band	<u>LTE band 7</u>
Channels	<u>Middle</u>
Signal	<u>LTE (Crest factor: 1.0)</u>
ConvF	<u>1.87</u>

B. SAR Measurement Results

Frequency (MHz)	2535.000000
Relative permittivity (real part)	38.162018
Relative permittivity (imaginary part)	13.337306
Conductivity (S/m)	1.878337
Variation (%)	-2.420000

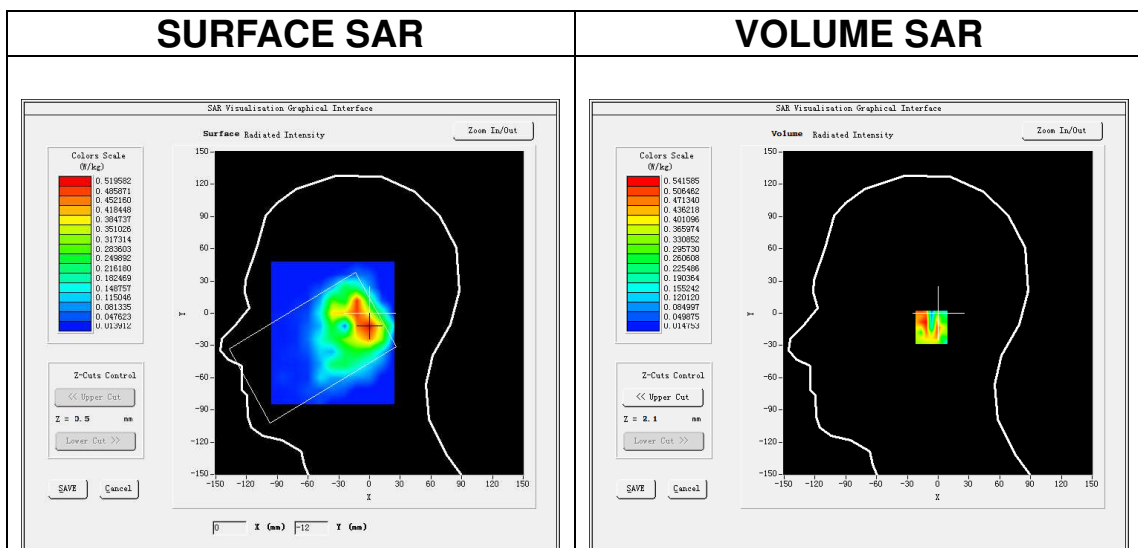

Maximum location: X=-1.00, Y=-13.00
SAR Peak: 1.11 W/kg

SAR 10g (W/Kg)	0.221273
SAR 1g (W/Kg)	0.471753

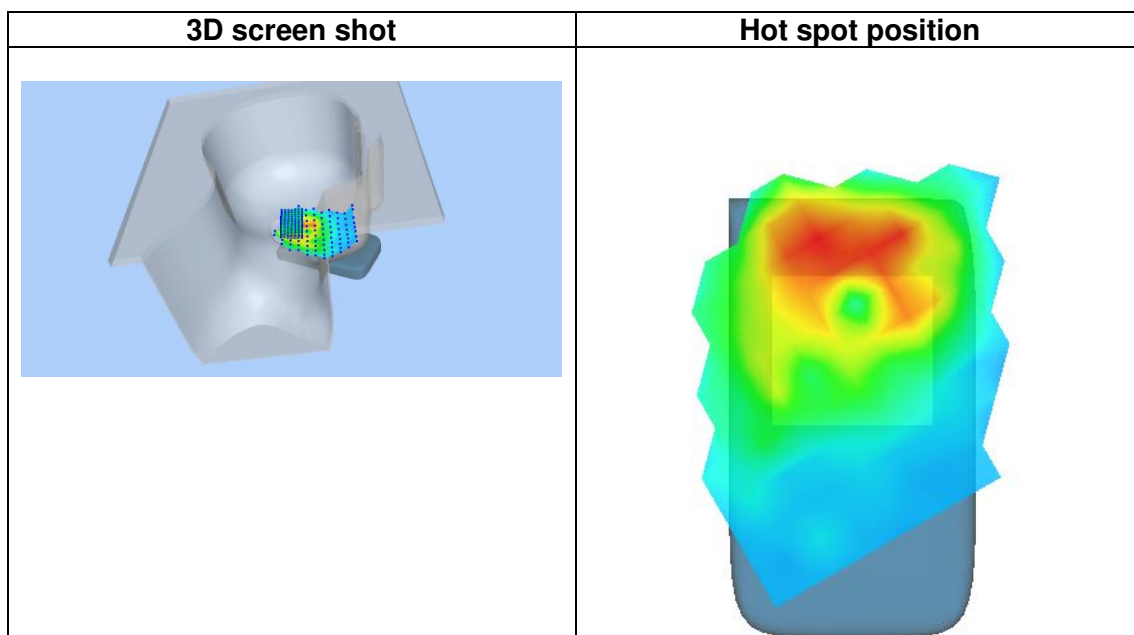
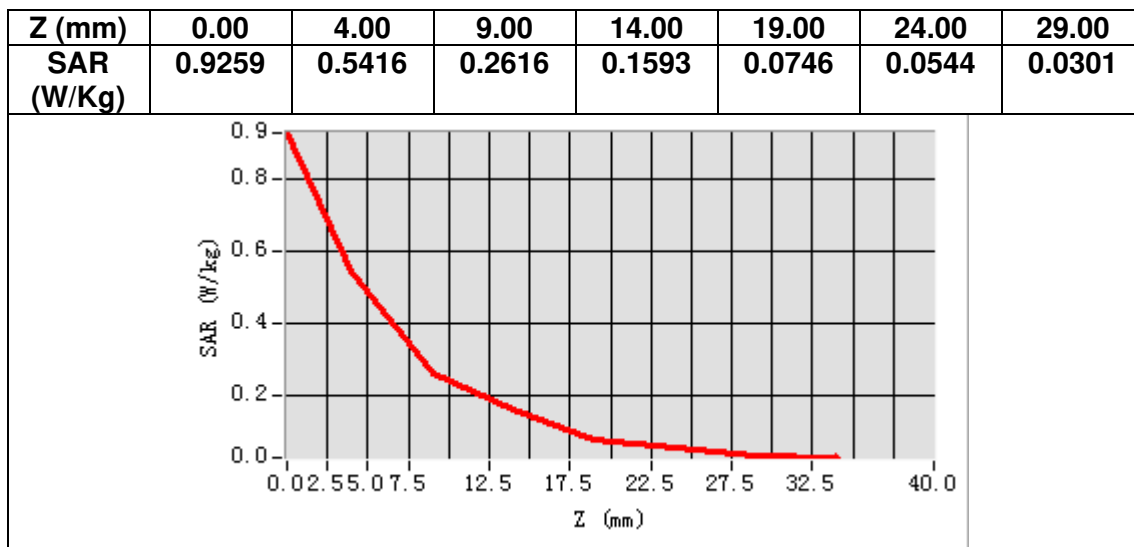

MEASUREMENT 20

Date of measurement: 10/11/2022

A. Experimental conditions.

Area Scan	<u>dx=12mm dy=12mm, h= 5.00 mm</u>
ZoomScan	<u>7x7x7, dx=5mm dy=5mm dz=5mm</u>
Phantom	<u>Validation plane</u>
Device Position	<u>Body</u>
Band	<u>LTE band 7</u>
Channels	<u>Middle</u>
Signal	<u>LTE (Crest factor: 1.0)</u>
ConvF	<u>1.87</u>

B. SAR Measurement Results

Frequency (MHz)	2535.000000
Relative permittivity (real part)	38.162018
Relative permittivity (imaginary part)	13.337306
Conductivity (S/m)	1.878337
Variation (%)	1.250000

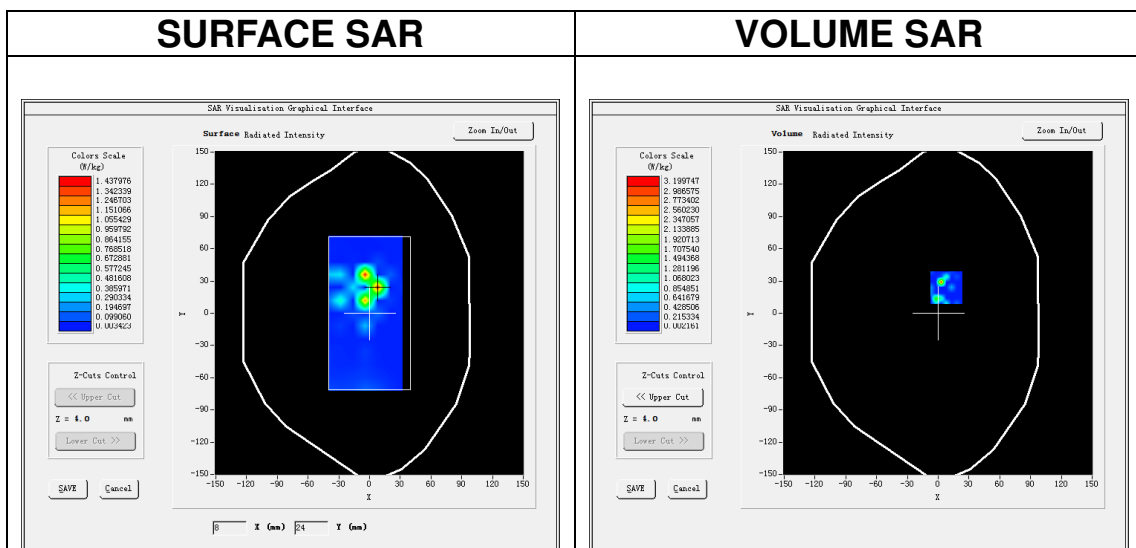

Maximum location: X=8.00, Y=24.00
SAR Peak: 6.08 W/kg

SAR 10g (W/Kg)	0.174276
SAR 1g (W/Kg)	1.137672

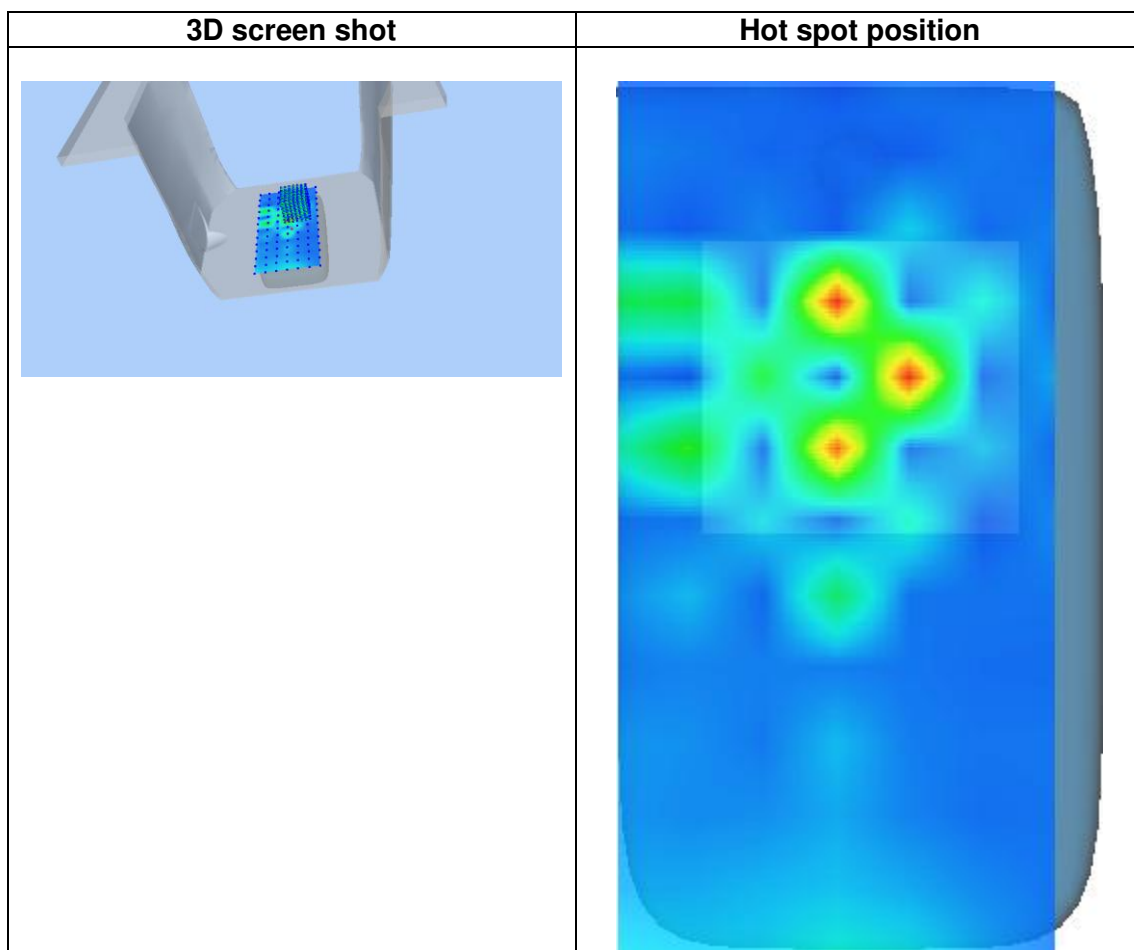

MEASUREMENT 21

Date of measurement: 7/11/2022

A. Experimental conditions.

Area Scan	<u>dx=15mm dy=15mm, h= 5.00 mm</u>
ZoomScan	<u>5x5x7,dx=8mm dy=8mm dz=5mm</u>
Phantom	<u>Left head</u>
Device Position	<u>Cheek</u>
Band	<u>LTE band 8</u>
Channels	<u>Middle</u>
Signal	<u>LTE (Crest factor: 1.0)</u>
ConvF	<u>1.61</u>

B. SAR Measurement Results

Frequency (MHz)	897.500000
Relative permittivity (real part)	39.950752
Relative permittivity (imaginary part)	19.453812
Conductivity (S/m)	0.969448
Variation (%)	-4.170000

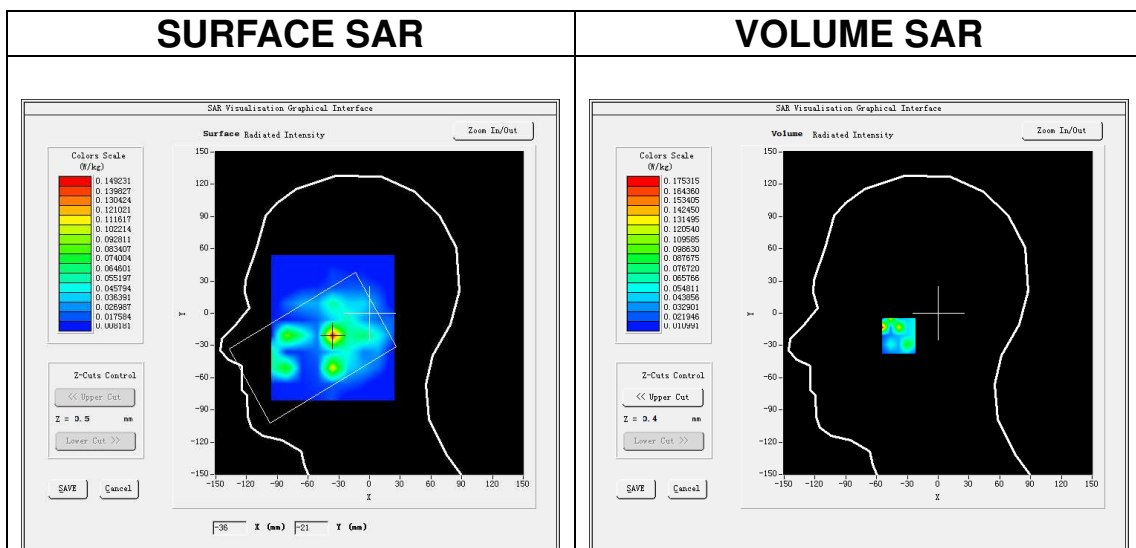

Maximum location: X=-36.00, Y=-21.00
SAR Peak: 0.26 W/kg

SAR 10g (W/Kg)	0.052128
SAR 1g (W/Kg)	0.088996

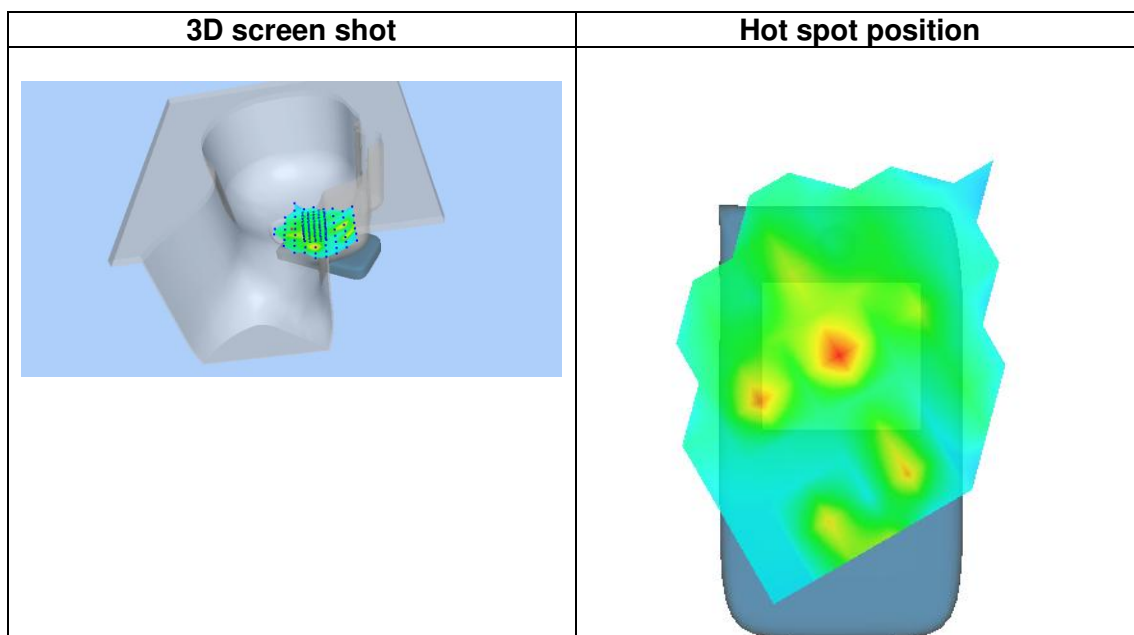
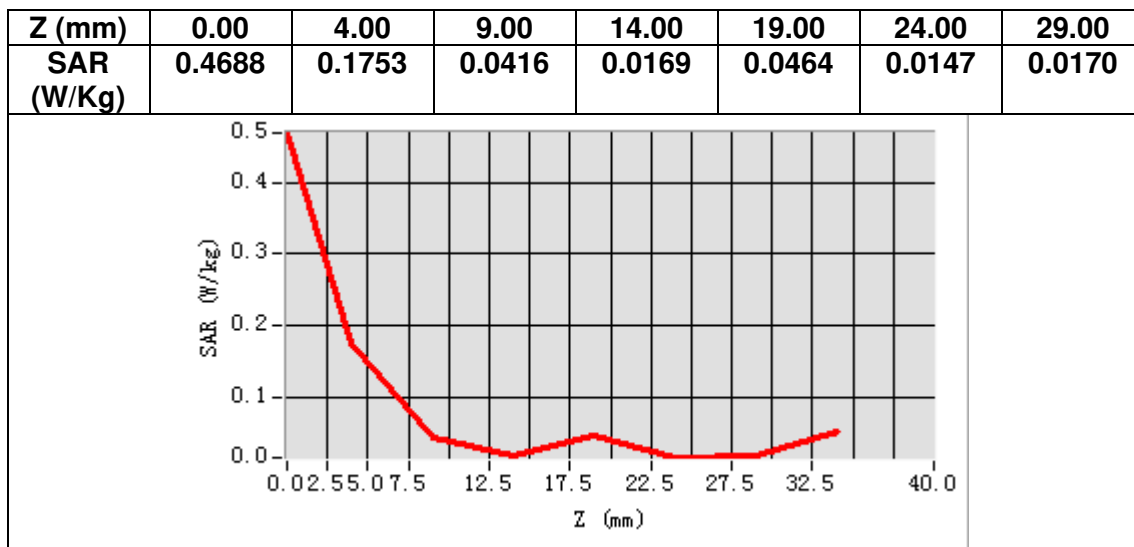

MEASUREMENT 22

Date of measurement: 7/11/2022

A. Experimental conditions.

Area Scan	<u>dx=15mm dy=15mm, h= 5.00 mm</u>
ZoomScan	<u>5x5x7, dx=8mm dy=8mm dz=5mm</u>
Phantom	<u>Validation plane</u>
Device Position	<u>Body</u>
Band	<u>LTE band 8</u>
Channels	<u>Middle</u>
Signal	<u>LTE (Crest factor: 1.0)</u>
ConvF	<u>1.61</u>

B. SAR Measurement Results

Frequency (MHz)	897.500000
Relative permittivity (real part)	39.950752
Relative permittivity (imaginary part)	19.453812
Conductivity (S/m)	0.969448
Variation (%)	3.740000

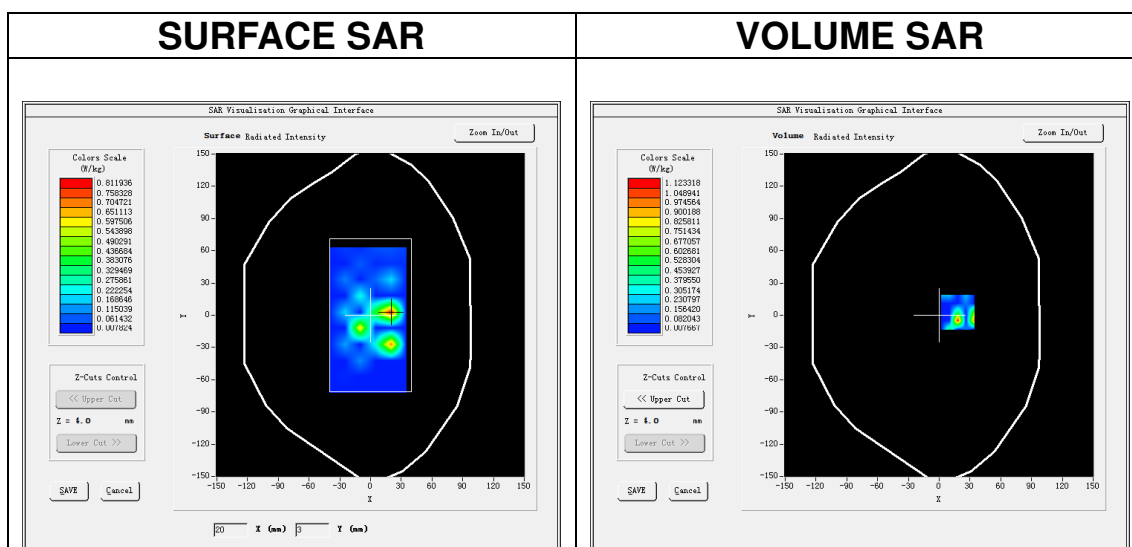

Maximum location: X=18.00, Y=3.00
SAR Peak: 3.42 W/kg

SAR 10g (W/Kg)	0.190702
SAR 1g (W/Kg)	0.833216

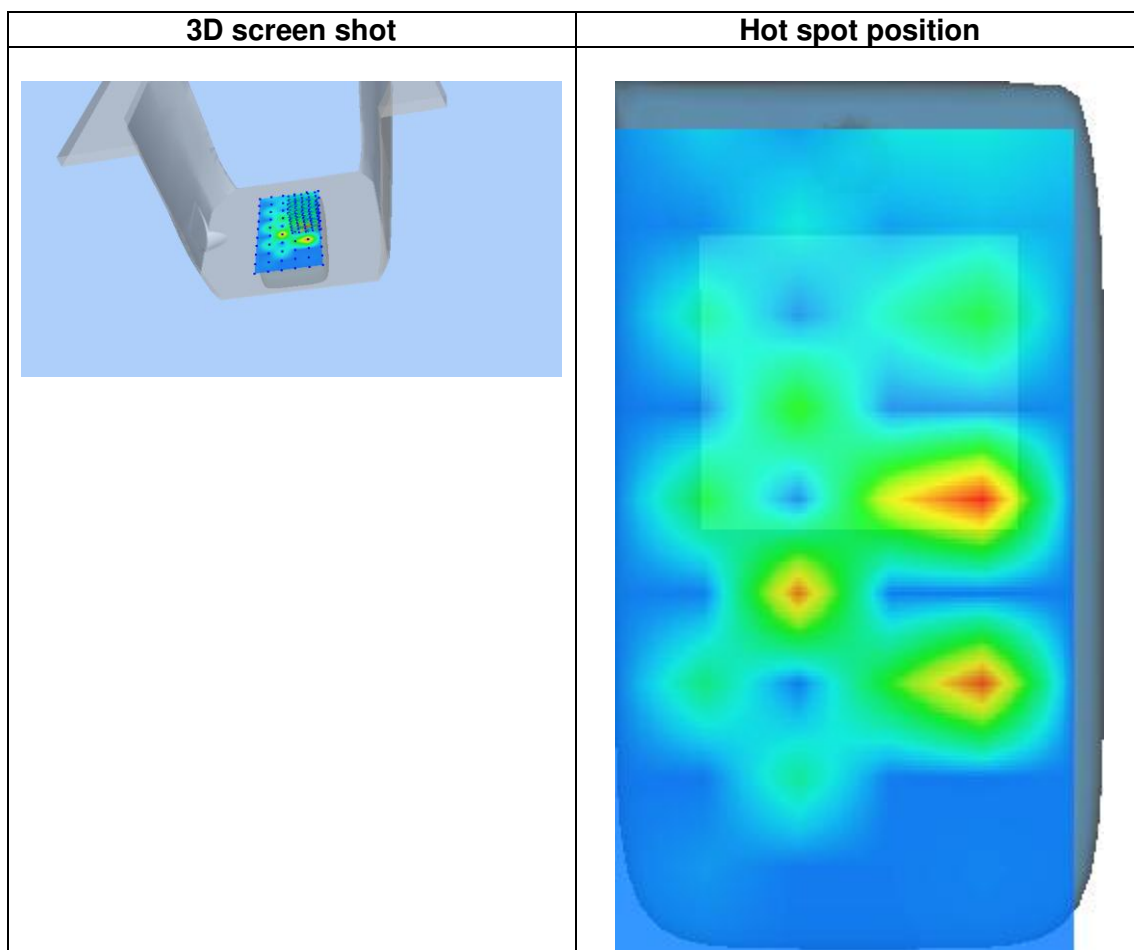
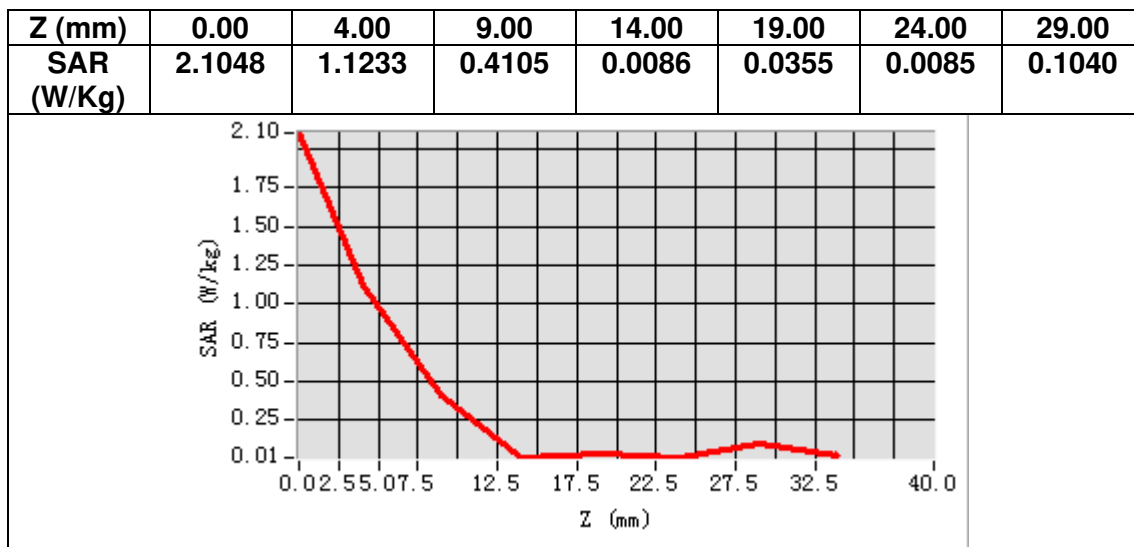

MEASUREMENT 23

Date of measurement: 7/11/2022

A. Experimental conditions.

Area Scan	<u>dx=15mm dy=15mm, h= 5.00 mm</u>
ZoomScan	<u>5x5x7,dx=8mm dy=8mm dz=5mm</u>
Phantom	<u>Left head</u>
Device Position	<u>Cheek</u>
Band	<u>LTE band 20</u>
Channels	<u>Middle</u>
Signal	<u>LTE (Crest factor: 1.0)</u>
ConvF	<u>1.61</u>

B. SAR Measurement Results

Frequency (MHz)	847.000000
Relative permittivity (real part)	40.569553
Relative permittivity (imaginary part)	19.238911
Conductivity (S/m)	0.905298
Variation (%)	0.100000

SURFACE SAR

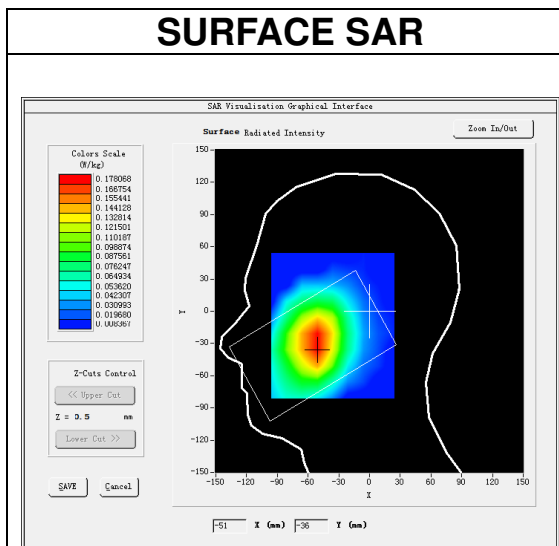

VOLUME SAR

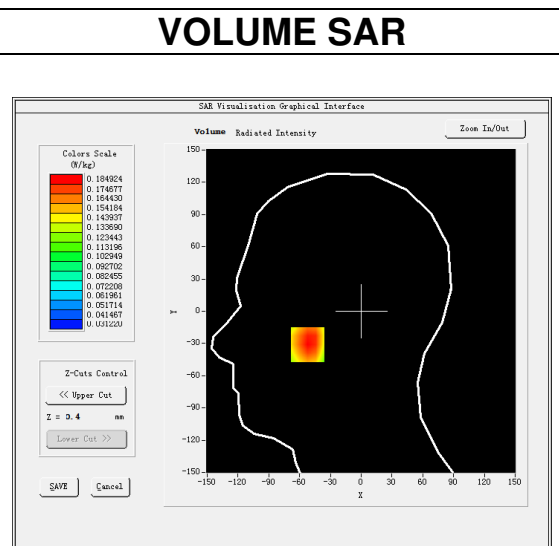

Maximum location: X=-52.00, Y=-31.00
SAR Peak: 0.23 W/kg

SAR 10g (W/Kg)	0.138776
SAR 1g (W/Kg)	0.180944

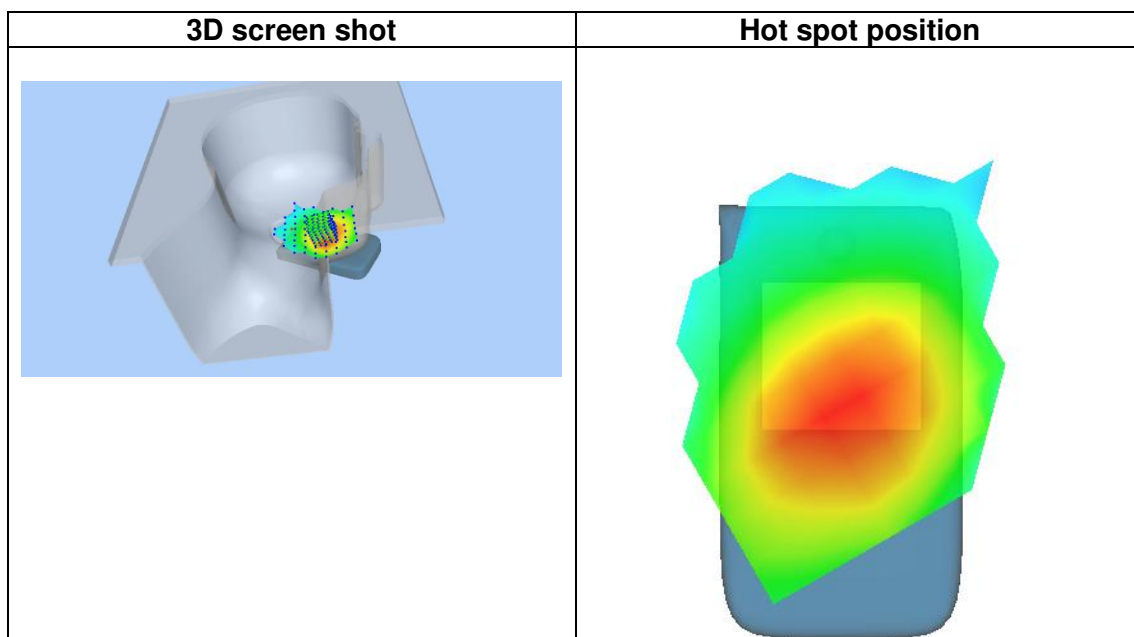
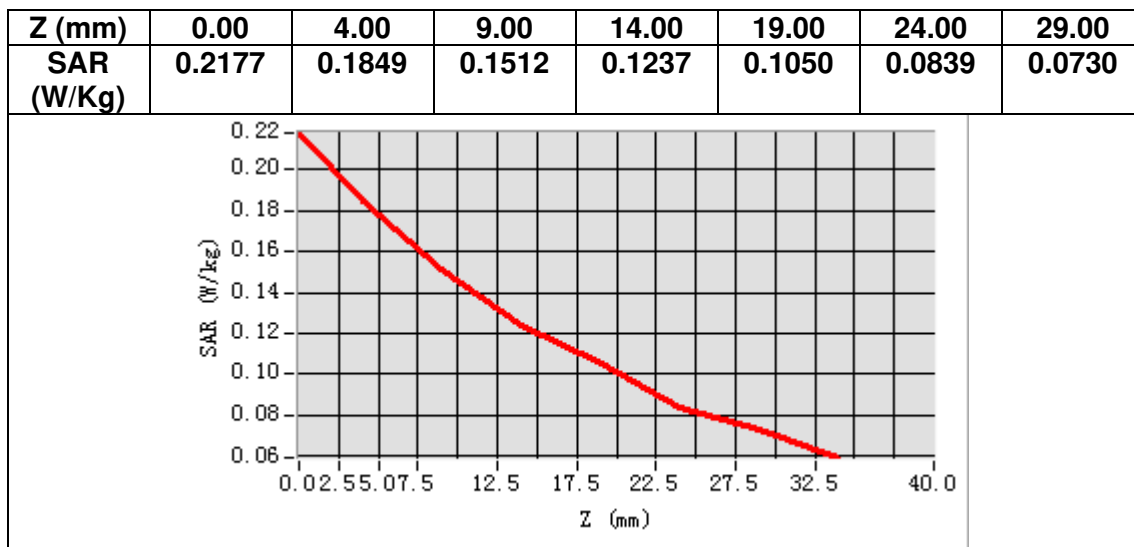

MEASUREMENT 24

Date of measurement: 7/11/2022

A. Experimental conditions.

Area Scan	<u>dx=15mm dy=15mm, h= 5.00 mm</u>
ZoomScan	<u>5x5x7, dx=8mm dy=8mm dz=5mm</u>
Phantom	<u>Validation plane</u>
Device Position	<u>Body</u>
Band	<u>LTE band 20</u>
Channels	<u>Middle</u>
Signal	<u>LTE (Crest factor: 1.0)</u>
ConvF	<u>1.61</u>

B. SAR Measurement Results

Frequency (MHz)	847.000000
Relative permittivity (real part)	40.569553
Relative permittivity (imaginary part)	19.238911
Conductivity (S/m)	0.905298
Variation (%)	-2.760000

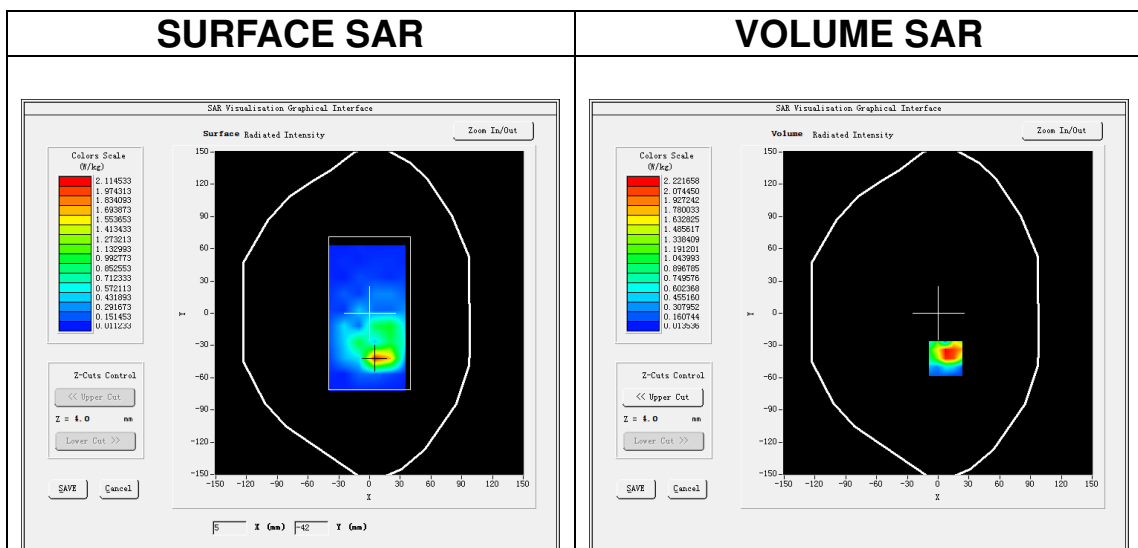

Maximum location: X=7.00, Y=-42.00
SAR Peak: 5.06 W/kg

SAR 10g (W/Kg)	1.051128
SAR 1g (W/Kg)	2.424129

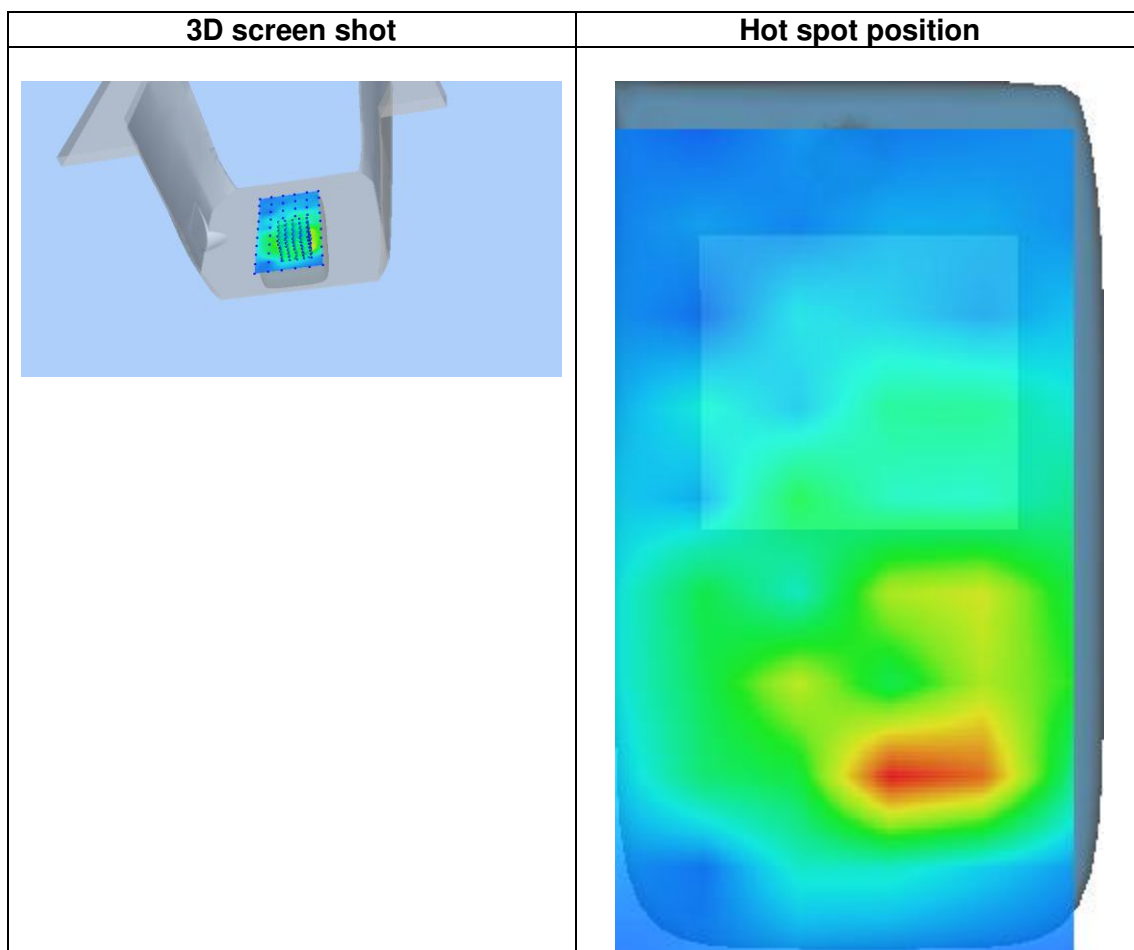
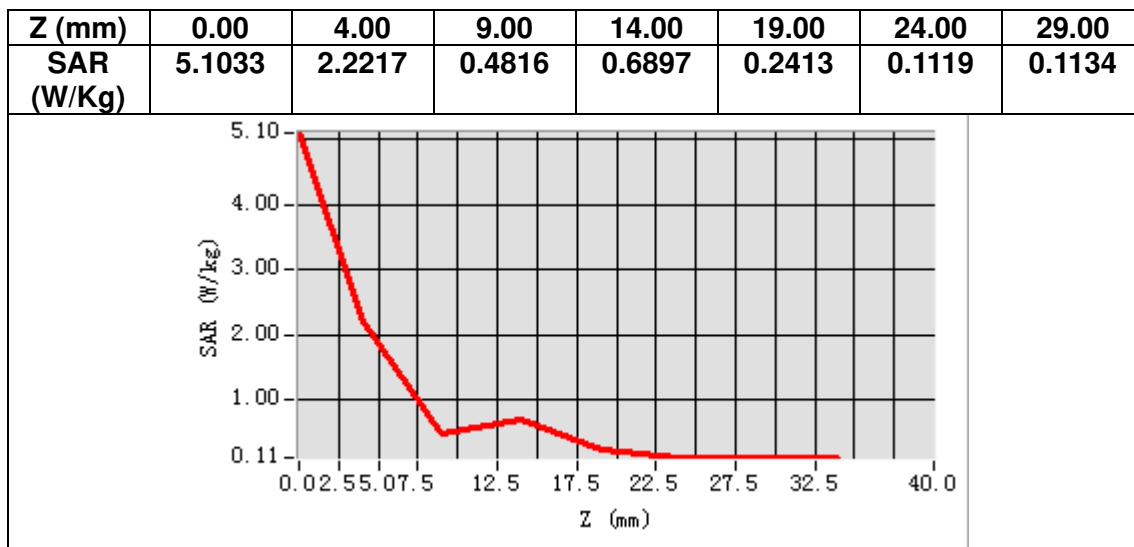

MEASUREMENT 25

Date of measurement: 9/11/2022

A. Experimental conditions.

Area Scan	<u>dx=12mm dy=12mm, h= 5.00 mm</u>
ZoomScan	<u>7x7x7,dx=5mm dy=5mm dz=5mm</u>
Phantom	<u>Left head</u>
Device Position	<u>Cheek</u>
Band	<u>LTE band 40</u>
Channels	<u>Middle</u>
Signal	<u>LTE (Crest factor: 1.6)</u>
ConvF	<u>1.92</u>

B. SAR Measurement Results

Frequency (MHz)	2350.000000
Relative permittivity (real part)	38.012402
Relative permittivity (imaginary part)	12.872648
Conductivity (S/m)	1.680596
Variation (%)	-3.450000

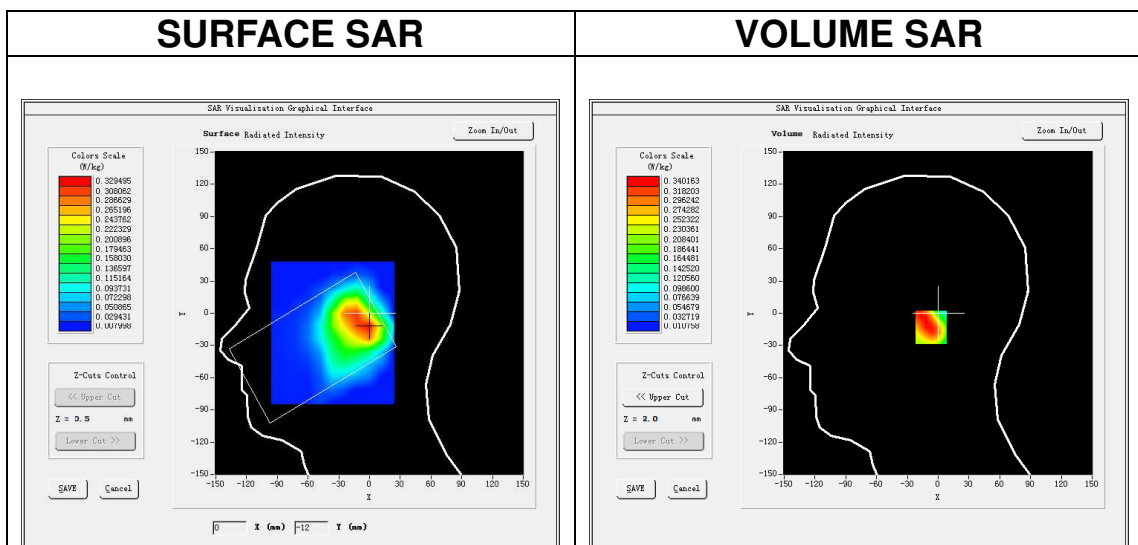

Maximum location: X=-2.00, Y=-13.00
SAR Peak: 0.51 W/kg

SAR 10g (W/Kg)	0.191565
SAR 1g (W/Kg)	0.319696

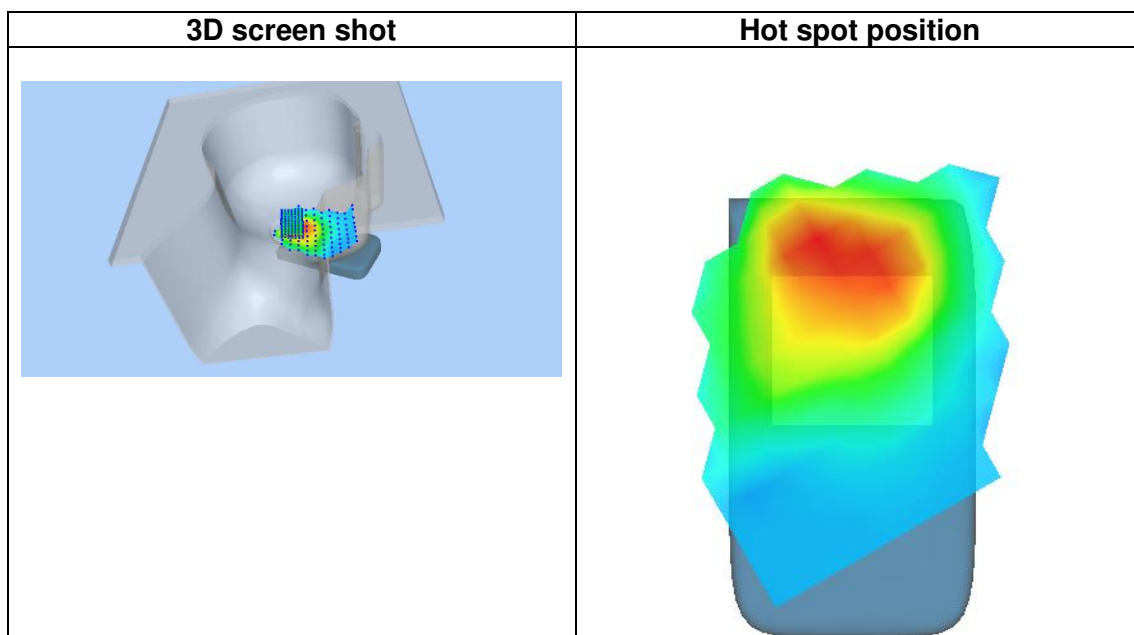
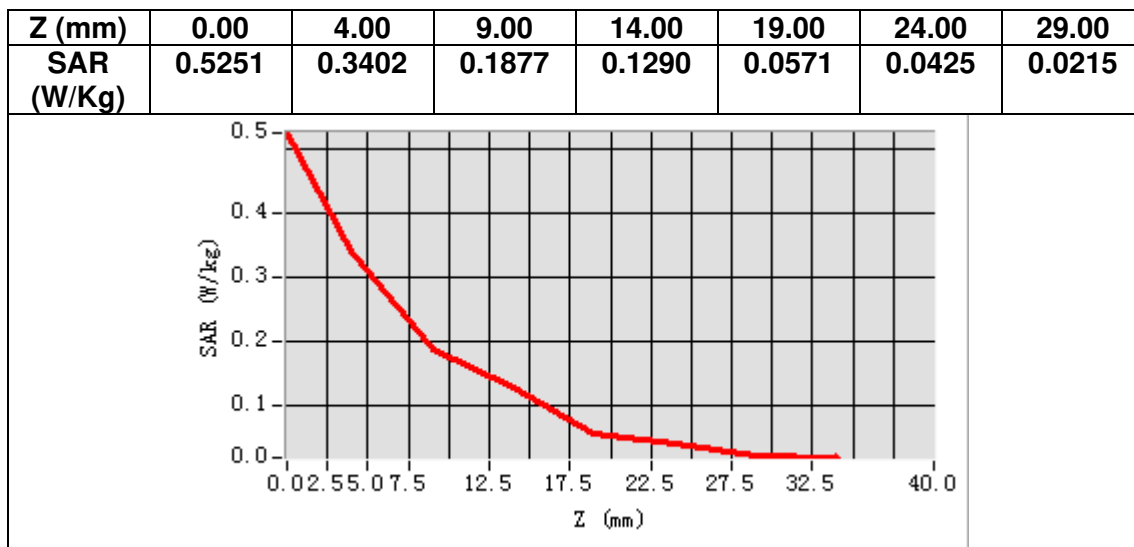

MEASUREMENT 26

Date of measurement: 9/11/2022

A. Experimental conditions.

Area Scan	<u>dx=12mm dy=12mm, h= 5.00 mm</u>
ZoomScan	<u>7x7x7,dx=5mm dy=5mm dz=5mm</u>
Phantom	<u>Validation plane</u>
Device Position	<u>Body</u>
Band	<u>LTE band 40</u>
Channels	<u>Middle</u>
Signal	<u>LTE (Crest factor: 1.6)</u>
ConvF	<u>1.92</u>

B. SAR Measurement Results

Frequency (MHz)	2350.000000
Relative permittivity (real part)	38.012402
Relative permittivity (imaginary part)	12.872648
Conductivity (S/m)	1.680596
Variation (%)	0.760000

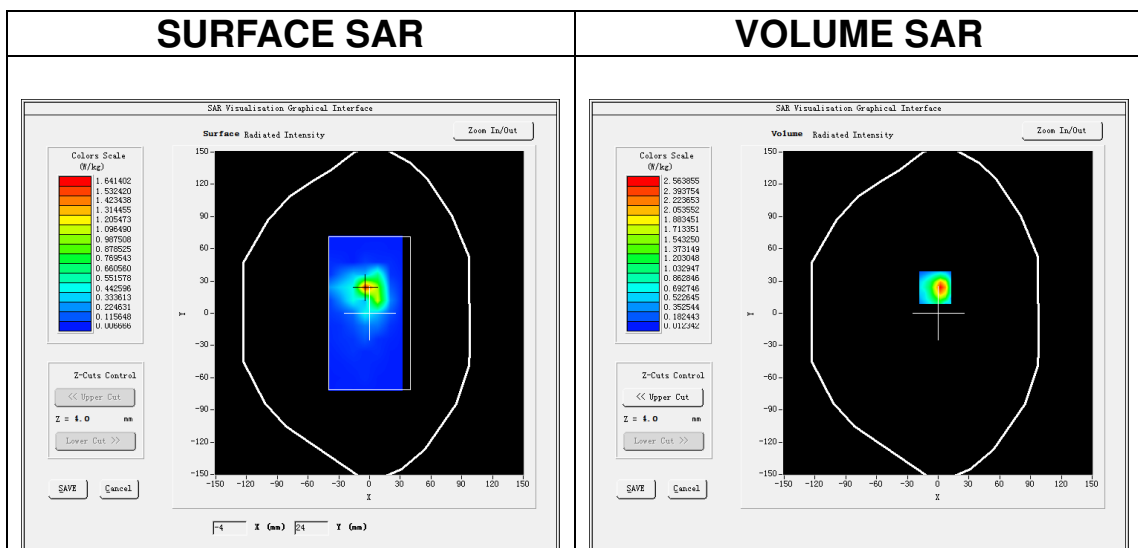

Maximum location: X=-3.00, Y=24.00
SAR Peak: 4.73 W/kg

SAR 10g (W/Kg)	0.833628
SAR 1g (W/Kg)	2.195140

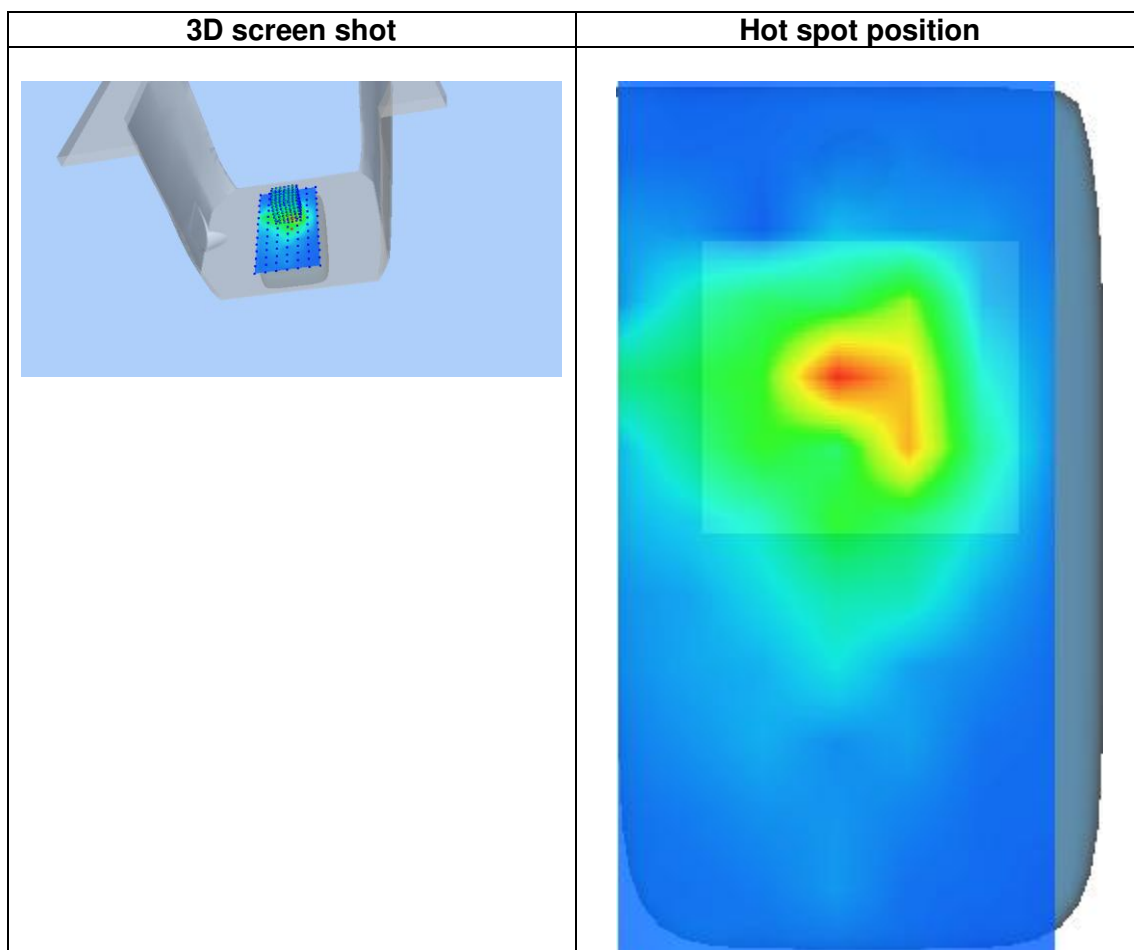
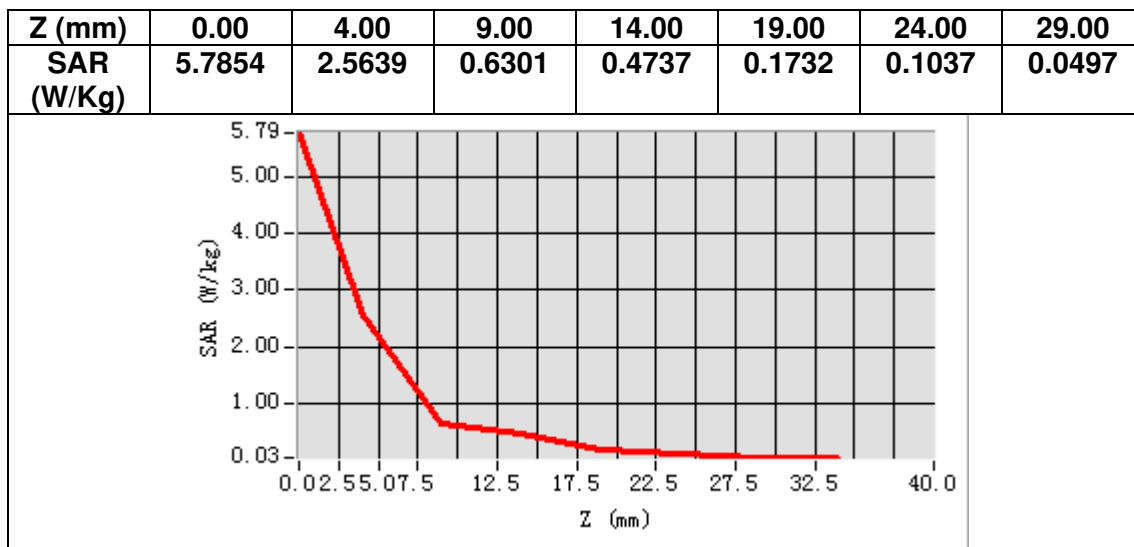

13. Appendix D. Calibration Certificate

Table of contents
E Field Probe - SN 08/16 EPGO287
900 MHz Dipole - SN 03/15 DIP 0G900-348
1800 MHz Dipole - SN 03/15 DIP 1G800-349
2000 MHz Dipole - SN 03/15 DIP 2G000-351
2300 MHz Dipole - SN 03/16 DIP 2G300-358
2450 MHz Dipole - SN 03/15 DIP 2G450-352
2600 MHz Dipole - SN 03/15 DIP 2G600-356
5000-6000 MHz Dipole - SN 13/14 WGA 33



COMOSAR E-Field Probe Calibration Report

Ref : ACR.60.1.21.MVGB.A

SHENZHEN NTEK TESTING TECHNOLOGY CO., LTD.

BUILDING E, FENDA SCIENCE PARK, SANWEI
COMMUNITY, XIXIANG STREET,
BAO'AN DISTRICT, SHENZHEN GUANGDONG, CHINA
MVG COMOSAR DOSIMETRIC E-FIELD PROBE
SERIAL NO.: SN 08/16 EPGO287

Calibrated at MVG

Z.I. de la pointe du diable

Technopôle Brest Iroise – 295 avenue Alexis de Rochon
29280 PLOUZANE - FRANCE

Calibration date: 02/01/2022



Accreditations #2-6789 and #2-6814
Scope available on www.cofrac.fr

Summary:

This document presents the method and results from an accredited COMOSAR E-Field Probe calibration performed at MVG, using the CALIPROBE test bench, for use with a MVG COMOSAR system only. The test results covered by accreditation are traceable to the International System of Units (SI).



COMOSAR E-FIELD PROBE CALIBRATION REPORT

Ref: ACR.60.1.21.MVGB.A

	Name	Function	Date	Signature
Prepared by :	Jérôme Luc	Technical Manager	2/1/2022	<i>JS</i>
Checked by :	Jérôme Luc	Technical Manager	2/1/2022	<i>JS</i>
Approved by :	Yann Toutain	Laboratory Director	2/1/2022	<i>Yann Toutain</i>

Mode d'emploi
2022.02.0
1 10:07:13
+01'00'

PHILIPS

	Customer Name
Distribution :	SHENZHEN NTEK TESTING TECHNOLOGY CO., LTD.

Issue	Name	Date	Modifications
A	Jérôme Luc	2/1/2022	Initial release



COMOSAR E-FIELD PROBE CALIBRATION REPORT

Ref. ACR.60.1.21.MVGB.A

TABLE OF CONTENTS

1	Device Under Test	4
2	Product Description	4
2.1	General Information	4
3	Measurement Method	4
3.1	Linearity	4
3.2	Sensitivity	5
3.3	Lower Detection Limit	5
3.4	Isotropy	5
3.1	Boundary Effect	5
4	Measurement Uncertainty	6
5	Calibration Measurement Results	6
5.1	Sensitivity in air	6
5.2	Linearity	7
5.3	Sensitivity in liquid	8
5.4	Isotropy	9
6	List of Equipment	10



COMOSAR E-FIELD PROBE CALIBRATION REPORT

Ref: ACR.60.1.21.MVGB.A

1 DEVICE UNDER TEST

Device Under Test	
Device Type	COMOSAR DOSIMETRIC E FIELD PROBE
Manufacturer	MVG
Model	SSE2
Serial Number	SN 08/16 EPGO287
Product Condition (new / used)	Used
Frequency Range of Probe	0.15 GHz-6GHz
Resistance of Three Dipoles at Connector	Dipole 1: R1=0.211 MΩ Dipole 2: R2=0.199 MΩ Dipole 3: R3=0.199 MΩ

2 PRODUCT DESCRIPTION

2.1 GENERAL INFORMATION

MVG’s COMOSAR E field Probes are built in accordance to the IEEE 1528, FCC KDB865664 D01, CENELEC EN62209 and CEI/IEC 62209 standards.



Figure 1 – MVG COMOSAR Dosimetric E field Dipole

Probe Length	330 mm
Length of Individual Dipoles	2 mm
Maximum external diameter	8 mm
Probe Tip External Diameter	2.5 mm
Distance between dipoles / probe extremity	1 mm

3 MEASUREMENT METHOD

The IEEE 1528, FCC KDB865664 D01, CENELEC EN62209 and CEI/IEC 62209 standards provide recommended practices for the probe calibrations, including the performance characteristics of interest and methods by which to assess their affect. All calibrations / measurements performed meet the fore mentioned standards.

3.1 LINEARITY

The evaluation of the linearity was done in free space using the waveguide, performing a power sweep to cover the SAR range 0.01W/kg to 100W/kg.



COMOSAR E-FIELD PROBE CALIBRATION REPORT

Ref: ACR.60.1.21.MVGB.A

3.2 SENSITIVITY

The sensitivity factors of the three dipoles were determined using a two step calibration method (air and tissue simulating liquid) using waveguides as outlined in the standards.

3.3 LOWER DETECTION LIMIT

The lower detection limit was assessed using the same measurement set up as used for the linearity measurement. The required lower detection limit is 10 mW/kg.

3.4 ISOTROPY

The axial isotropy was evaluated by exposing the probe to a reference wave from a standard dipole with the dipole mounted under the flat phantom in the test configuration suggested for system validations and checks. The probe was rotated along its main axis from 0 to 360 degrees in 15-degree steps. The hemispherical isotropy is determined by inserting the probe in a thin plastic box filled with tissue-equivalent liquid, with the plastic box illuminated with the fields from a half wave dipole. The dipole is rotated about its axis (0°–180°) in 15° increments. At each step the probe is rotated about its axis (0°–360°).

3.1 BOUNDARY EFFECT

The boundary effect is defined as the deviation between the SAR measured data and the expected exponential decay in the liquid when the probe is oriented normal to the interface. To evaluate this effect, the liquid filled flat phantom is exposed to fields from either a reference dipole or waveguide. With the probe normal to the phantom surface, the peak spatial average SAR is measured and compared to the analytical value at the surface.

The boundary effect uncertainty can be estimated according to the following uncertainty approximation formula based on linear and exponential extrapolations between the surface and $d_{be} + d_{step}$ along lines that are approximately normal to the surface:

$$SAR_{uncertainty} [\%] = \Delta SAR_{be} \frac{(d_{be} + d_{step})^2}{2d_{step}} \frac{(e^{-\alpha_{be}(d_{be} + d_{step})})}{\delta/2} \text{ for } (d_{be} + d_{step}) < 10 \text{ mm}$$

where

- $SAR_{uncertainty}$ is the uncertainty in percent of the probe boundary effect
- d_{be} is the distance between the surface and the closest *zoom-scan* measurement point, in millimetre
- Δ_{step} is the separation distance between the first and second measurement points that are closest to the phantom surface, in millimetre, assuming the boundary effect at the second location is negligible
- δ is the minimum penetration depth in millimetres of the head tissue-equivalent liquids defined in this standard, i.e., $\delta \approx 14$ mm at 3 GHz;
- ΔSAR_{be} in percent of SAR is the deviation between the measured SAR value, at the distance d_{be} from the boundary, and the analytical SAR value.



COMOSAR E-FIELD PROBE CALIBRATION REPORT

Ref. ACR.60.1.21.MVGB.A

The measured worst case boundary effect SARuncertainty[%] for scanning distances larger than 4mm is 1.0% Limit ,2%).

4 MEASUREMENT UNCERTAINTY

The guidelines outlined in the IEEE 1528, OET 65 Bulletin C, CENELEC EN50361 and CEI/IEC 62209 standards were followed to generate the measurement uncertainty associated with an E-field probe calibration using the waveguide technique. All uncertainties listed below represent an expanded uncertainty expressed at approximately the 95% confidence level using a coverage factor of k=2, traceable to the Internationally Accepted Guides to Measurement Uncertainty.

Uncertainty analysis of the probe calibration in waveguide					
ERROR SOURCES	Uncertainty value (%)	Probability Distribution	Divisor	ci	Standard Uncertainty (%)
Expanded uncertainty 95 % confidence level k = 2					14 %

5 CALIBRATION MEASUREMENT RESULTS

Calibration Parameters	
Liquid Temperature	20 +/- 1 °C
Lab Temperature	20 +/- 1 °C
Lab Humidity	30-70 %

5.1 SENSITIVITY IN AIR

Normx dipole 1 (µV/(V/m) ²)	Normy dipole 2 (µV/(V/m) ²)	Normz dipole 3 (µV/(V/m) ²)
0.72	0.66	0.77

DCP dipole 1 (mV)	DCP dipole 2 (mV)	DCP dipole 3 (mV)
107	110	110

Calibration curves ei=f(V) (i=1,2,3) allow to obtain E-field value using the formula:

$$E = \sqrt{E_1^2 + E_2^2 + E_3^2}$$



COMOSAR E-FIELD PROBE CALIBRATION REPORT

Ref: ACR.60.1.21.MVGB.A

Calibration curves

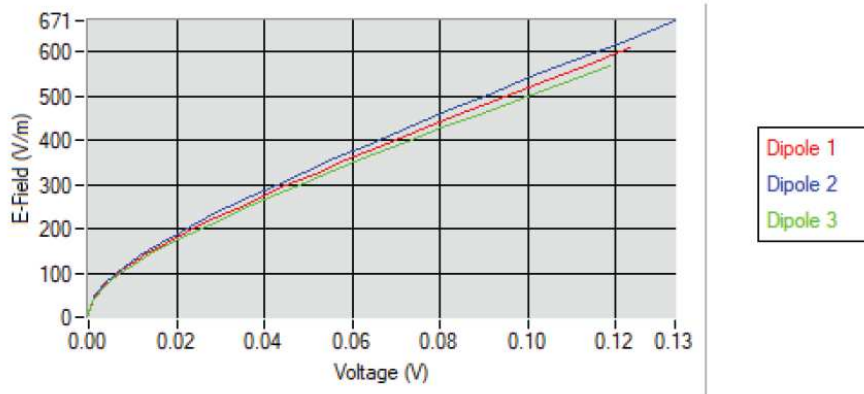

5.2 LINEARITY

Linearity

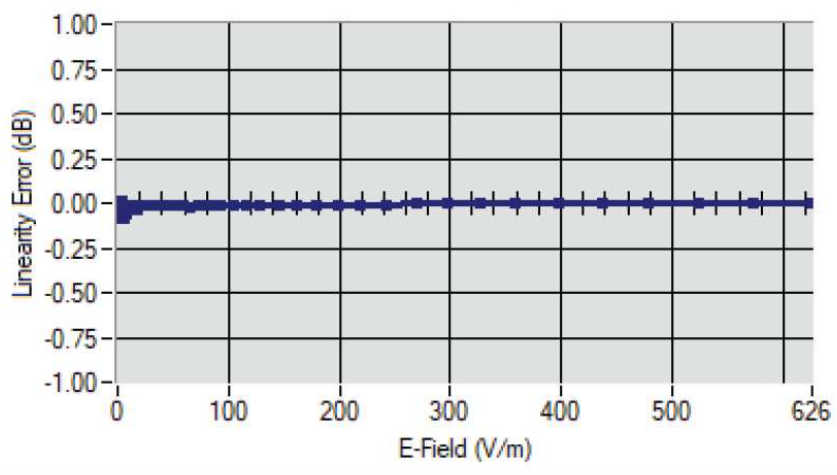

Linearity: $\pm 1.90\%$ ($\pm 0.08\text{dB}$)



COMOSAR E-FIELD PROBE CALIBRATION REPORT

Ref: ACR.60.1.21.MVGB.A

5.3 SENSITIVITY IN LIQUID

Liquid	Frequency (MHz +/- 100MHz)	ConvF
HL750	750	1.49
HL850	835	1.50
HL900	900	1.61
HL1800	1800	1.73
HL1900	1900	1.91
HL2000	2000	1.97
HL2300	2300	1.92
HL2450	2450	1.98
HL2600	2600	1.87
HL3300	3300	1.79
HL3500	3500	1.85
HL3700	3700	1.79
HL3900	3900	2.07
HL4200	4200	2.21
HL4600	4600	2.25
HL4900	4900	2.05
HL5200	5200	1.80
HL5400	5400	2.05
HL5600	5600	2.16
HL5800	5800	2.07

LOWER DETECTION LIMIT: 8mW/kg



COMOSAR E-FIELD PROBE CALIBRATION REPORT

Ref: ACR.60.1.21.MVGB.A

5.4 ISOTROPY

HL1800 MHz

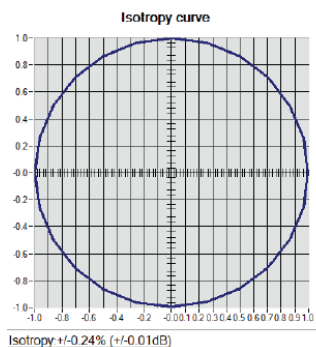



COMOSAR E-FIELD PROBE CALIBRATION REPORT

Ref: ACR.60.1.21.MVGB.A

6 LIST OF EQUIPMENT

Equipment Summary Sheet				
Equipment Description	Manufacturer / Model	Identification No.	Current Calibration Date	Next Calibration Date
Flat Phantom	MVG	SN-20/09-SAM71	Validated. No cal required.	Validated. No cal required.
COMOSAR Test Bench	Version 3	NA	Validated. No cal required.	Validated. No cal required.
Network Analyzer	Rohde & Schwarz ZVM	100203	05/2019	05/2022
Network Analyzer – Calibration kit	Rohde & Schwarz ZV-Z235	101223	05/2019	05/2022
Multimeter	Keithley 2000	1160271	02/2020	02/2023
Signal Generator	Rohde & Schwarz SMB	106589	04/2019	04/2022
Amplifier	Aethercomm	SN 046	Characterized prior to test. No cal required.	Characterized prior to test. No cal required.
Power Meter	NI-USB 5680	170100013	05/2019	05/2022
Directional Coupler	Narda 4216-20	01386	Characterized prior to test. No cal required.	Characterized prior to test. No cal required.
Waveguide	Mega Industries	069Y7-158-13-712	Validated. No cal required.	Validated. No cal required.
Waveguide Transition	Mega Industries	069Y7-158-13-701	Validated. No cal required.	Validated. No cal required.
Waveguide Termination	Mega Industries	069Y7-158-13-701	Validated. No cal required.	Validated. No cal required.
Temperature / Humidity Sensor	Testo 184 H1	44220687	05/2020	05/2023



SAR Reference Dipole Calibration Report

Ref : ACR.60.4.21.MVGB.A

SHENZHEN NTEK TESTING TECHNOLOGY CO., LTD.

BUILDING E, FENDA SCIENCE PARK, SANWEI
COMMUNITY, XIXIANG STREET,
BAO'AN DISTRICT, SHENZHEN GUANGDONG, CHINA

MVG COMOSAR REFERENCE DIPOLE

FREQUENCY: 900 MHZ

SERIAL NO.: SN 03/15 DIP0G900-348

Calibrated at MVG

Z.I. de la pointe du diable

Technopôle Brest Iroise – 295 avenue Alexis de Rochon
29280 PLOUZANE - FRANCE

Calibration date: 03/01/2021



Accreditations #2-6789 and #2-6814
Scope available on www.cofrac.fr

Summary:

This document presents the method and results from an accredited SAR reference dipole calibration performed at MVG, using the COMOSAR test bench. The test results covered by accreditation are traceable to the International System of Units (SI).



SAR REFERENCE DIPOLE CALIBRATION REPORT

Ref: ACR.60.4.21.MVGB.A

	<i>Name</i>	<i>Function</i>	<i>Date</i>	<i>Signature</i>
<i>Prepared by :</i>	Jérôme Luc	Technical Manager	3/1/2021	<i>JLS</i>
<i>Checked by :</i>	Jérôme Luc	Technical Manager	3/1/2021	<i>JLS</i>
<i>Approved by :</i>	Yann Toutain	Laboratory Director	3/1/2021	<i>Yann Toutain</i>

Made d'emplac 2021.03.0
1
13:09:56
+01'00'
PHILIPS

	<i>Customer Name</i>
<i>Distribution :</i>	SHENZHEN NTEK TESTING TECHNOLOGY CO., LTD.

<i>Issue</i>	<i>Name</i>	<i>Date</i>	<i>Modifications</i>
A	Jérôme Luc	3/1/2021	Initial release



SAR REFERENCE DIPOLE CALIBRATION REPORT

Ref: ACR.60.4.21.MVGB.A

TABLE OF CONTENTS

1	Introduction.....	4
2	Device Under Test	4
3	Product Description	4
3.1	General Information	4
4	Measurement Method	5
4.1	Return Loss Requirements	5
4.2	Mechanical Requirements	5
5	Measurement Uncertainty.....	5
5.1	Return Loss	5
5.2	Dimension Measurement	5
5.3	Validation Measurement	5
6	Calibration Measurement Results.....	6
6.1	Return Loss and Impedance	6
6.2	Mechanical Dimensions	6
7	Validation measurement	7
7.1	Measurement Condition	7
7.2	Head Liquid Measurement	7
7.3	Measurement Result	8
8	List of Equipment	10



SAR REFERENCE DIPOLE CALIBRATION REPORT

Ref. ACR.60.4.21.MVGB.A

1 INTRODUCTION

This document contains a summary of the requirements set forth by the IEEE 1528, FCC KDBs and CEI/IEC 62209 standards for reference dipoles used for SAR measurement system validations and the measurements that were performed to verify that the product complies with the fore mentioned standards.

2 DEVICE UNDER TEST

Device Under Test	
Device Type	COMOSAR 900 MHz REFERENCE DIPOLE
Manufacturer	MVG
Model	SID900
Serial Number	SN 03/15 DIP0G900-348
Product Condition (new / used)	Used

3 PRODUCT DESCRIPTION

3.1 GENERAL INFORMATION

MVG’s COMOSAR Validation Dipoles are built in accordance to the IEEE 1528, FCC KDBs and CEI/IEC 62209 standards. The product is designed for use with the COMOSAR test bench only.



Figure 1 – MVG COMOSAR Validation Dipole



SAR REFERENCE DIPOLE CALIBRATION REPORT

Ref: ACR.60.4.21.MVGB.A

4 MEASUREMENT METHOD

The IEEE 1528, FCC KDBs and CEI/IEC 62209 standards provide requirements for reference dipoles used for system validation measurements. The following measurements were performed to verify that the product complies with the fore mentioned standards.

4.1 RETURN LOSS REQUIREMENTS

The dipole used for SAR system validation measurements and checks must have a return loss of -20 dB or better. The return loss measurement shall be performed against a liquid filled flat phantom, with the phantom constructed as outlined in the fore mentioned standards. A direct method is used with a network analyser and its calibration kit, both with a valid ISO17025 calibration.

4.2 MECHANICAL REQUIREMENTS

The IEEE Std. 1528 and CEI/IEC 62209 standards specify the mechanical components and dimensions of the validation dipoles, with the dimension's frequency and phantom shell thickness dependent. The COMOSAR test bench employs a 2 mm phantom shell thickness therefore the dipoles sold for use with the COMOSAR test bench comply with the requirements set forth for a 2 mm phantom shell thickness. A direct method is used with a ISO17025 calibrated caliper.

5 MEASUREMENT UNCERTAINTY

All uncertainties listed below represent an expanded uncertainty expressed at approximately the 95% confidence level using a coverage factor of k=2, traceable to the Internationally Accepted Guides to Measurement Uncertainty.

5.1 RETURN LOSS

The following uncertainties apply to the return loss measurement:

Frequency band	Expanded Uncertainty on Return Loss
400-6000MHz	0.08 LIN

5.2 DIMENSION MEASUREMENT

The following uncertainties apply to the dimension measurements:

Length (mm)	Expanded Uncertainty on Length
0 - 300	0.20 mm
300 - 450	0.44 mm

5.3 VALIDATION MEASUREMENT

The guidelines outlined in the IEEE 1528, FCC KDBs, CENELEC EN50361 and CEI/IEC 62209 standards were followed to generate the measurement uncertainty for validation measurements.

Scan Volume	Expanded Uncertainty



SAR REFERENCE DIPOLE CALIBRATION REPORT

Ref. ACR.60.4.21.MVGB.A

1 g	19 % (SAR)
10 g	19 % (SAR)

6 CALIBRATION MEASUREMENT RESULTS

6.1 RETURN LOSS AND IMPEDANCE

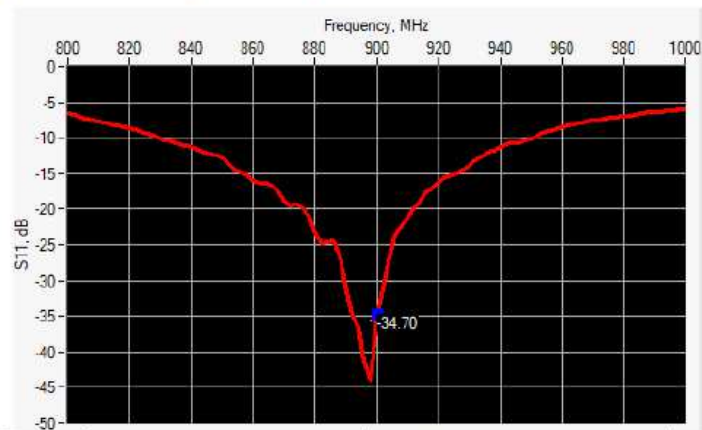

Frequency (MHz)	Return Loss (dB)	Requirement (dB)	Impedance
900	-34.70	-20	51.0 Ω - 1.5 jΩ

6.2 MECHANICAL DIMENSIONS

Frequency MHz	L mm		h mm		d mm	
	required	measured	required	measured	required	measured
300	420.0 ±1 %.		250.0 ±1 %.		6.35 ±1 %.	
450	290.0 ±1 %.		166.7 ±1 %.		6.35 ±1 %.	
750	176.0 ±1 %.		100.0 ±1 %.		6.35 ±1 %.	
835	161.0 ±1 %.		89.8 ±1 %.		3.6 ±1 %.	
900	149.0 ±1 %.	-	83.3 ±1 %.	-	3.6 ±1 %.	-
1450	89.1 ±1 %.		51.7 ±1 %.		3.6 ±1 %.	
1500	80.5 ±1 %.		50.0 ±1 %.		3.6 ±1 %.	
1640	79.0 ±1 %.		45.7 ±1 %.		3.6 ±1 %.	
1750	75.2 ±1 %.		42.9 ±1 %.		3.6 ±1 %.	
1800	72.0 ±1 %.		41.7 ±1 %.		3.6 ±1 %.	
1900	68.0 ±1 %.		39.5 ±1 %.		3.6 ±1 %.	
1950	66.3 ±1 %.		38.5 ±1 %.		3.6 ±1 %.	
2000	64.5 ±1 %.		37.5 ±1 %.		3.6 ±1 %.	
2100	61.0 ±1 %.		35.7 ±1 %.		3.6 ±1 %.	
2300	55.5 ±1 %.		32.6 ±1 %.		3.6 ±1 %.	
2450	51.5 ±1 %.		30.4 ±1 %.		3.6 ±1 %.	



SAR REFERENCE DIPOLE CALIBRATION REPORT

Ref. ACR.60.4.21.MVGB.A

2600	48.5 ±1 %.		28.8 ±1 %.		3.6 ±1 %.	
3000	41.5 ±1 %.		25.0 ±1 %.		3.6 ±1 %.	
3500	37.0±1 %.		26.4 ±1 %.		3.6 ±1 %.	
3700	34.7±1 %.		26.4 ±1 %.		3.6 ±1 %.	

7 VALIDATION MEASUREMENT

The IEEE Std. 1528, FCC KDBs and CEI/IEC 62209 standards state that the system validation measurements must be performed using a reference dipole meeting the fore mentioned return loss and mechanical dimension requirements. The validation measurement must be performed against a liquid filled flat phantom, with the phantom constructed as outlined in the fore mentioned standards. Per the standards, the dipole shall be positioned below the bottom of the phantom, with the dipole length centered and parallel to the longest dimension of the flat phantom, with the top surface of the dipole at the described distance from the bottom surface of the phantom.

7.1 MEASUREMENT CONDITION

Software	OPENSAR V5
Phantom	SN 13/09 SAM68
Probe	SN 41/18 EPGO333
Liquid	Head Liquid Values: eps' : 39.8 sigma : 0.97
Distance between dipole center and liquid	15.0 mm
Area scan resolution	dx=8mm/dy=8mm
Zoon Scan Resolution	dx=8mm/dy=8mm/dz=5mm
Frequency	900900 MHz
Input power	20 dBm
Liquid Temperature	20 +/- 1 °C
Lab Temperature	20 +/- 1 °C
Lab Humidity	30-70 %

7.2 HEAD LIQUID MEASUREMENT

Frequency MHz	Relative permittivity (ε _r)		Conductivity (σ) S/m	
	required	measured	required	measured
300	45.3 ±10 %		0.87 ±10 %	
450	43.5 ±10 %		0.87 ±10 %	
750	41.9 ±10 %		0.89 ±10 %	
835	41.5 ±10 %		0.90 ±10 %	
900	41.5 ±10 %	39.8	0.97 ±10 %	0.97
1450	40.5 ±10 %		1.20 ±10 %	
1500	40.4 ±10 %		1.23 ±10 %	
1640	40.2 ±10 %		1.31 ±10 %	
1750	40.1 ±10 %		1.37 ±10 %	
1800	40.0 ±10 %		1.40 ±10 %	
1900	40.0 ±10 %		1.40 ±10 %	
1950	40.0 ±10 %		1.40 ±10 %	
2000	40.0 ±10 %		1.40 ±10 %	



SAR REFERENCE DIPOLE CALIBRATION REPORT

Ref. ACR.60.4.21.MVGB.A

2100	39.8 ±10 %		1.49 ±10 %	
2300	39.5 ±10 %		1.67 ±10 %	
2450	39.2 ±10 %		1.80 ±10 %	
2600	39.0 ±10 %		1.96 ±10 %	
3000	38.5 ±10 %		2.40 ±10 %	
3500	37.9 ±10 %		2.91 ±10 %	

7.3 MEASUREMENT RESULT

The IEEE Std. 1528 and CEI/IEC 62209 standards state that the system validation measurements should produce the SAR values shown below (for phantom thickness of 2 mm), within the uncertainty for the system validation. All SAR values are normalized to 1 W forward power. In bracket, the measured SAR is given with the used input power.

Frequency MHz	1 g SAR (W/kg/W)		10 g SAR (W/kg/W)	
	required	measured	required	measured
300	2.85		1.94	
450	4.58		3.06	
750	8.49		5.55	
835	9.56		6.22	
900	10.9	11.08 (1.11)	6.99	6.81 (0.68)
1450	29		16	
1500	30.5		16.8	
1640	34.2		18.4	
1750	36.4		19.3	
1800	38.4		20.1	
1900	39.7		20.5	
1950	40.5		20.9	
2000	41.1		21.1	
2100	43.6		21.9	
2300	48.7		23.3	
2450	52.4		24	
2600	55.3		24.6	
3000	63.8		25.7	
3500	67.1		25	



SAR REFERENCE DIPOLE CALIBRATION REPORT

Ref: ACR.60.4.21.MVGB.A

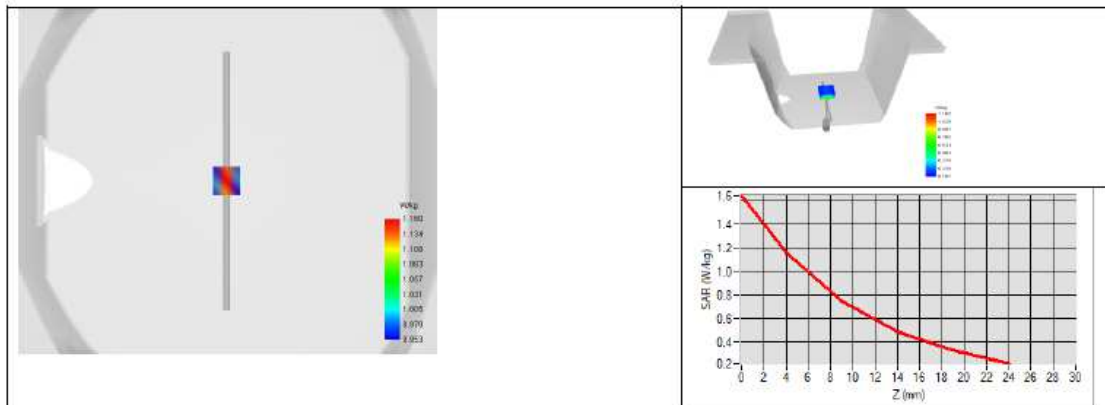



SAR REFERENCE DIPOLE CALIBRATION REPORT

Ref. ACR.60.4.21.MVGB.A

8 LIST OF EQUIPMENT

Equipment Summary Sheet				
Equipment Description	Manufacturer / Model	Identification No.	Current Calibration Date	Next Calibration Date
SAM Phantom	MVG	SN-13/09-SAM68	Validated. No cal required.	Validated. No cal required.
COMOSAR Test Bench	Version 3	NA	Validated. No cal required.	Validated. No cal required.
Network Analyzer	Rohde & Schwarz ZVM	100203	05/2019	05/2022
Network Analyzer – Calibration kit	Rohde & Schwarz ZV-Z235	101223	05/2019	05/2022
Calipers	Mitutoyo	SN 0009732	10/2019	10/2022
Reference Probe	MVG	EPGO333 SN 41/18	05/2020	05/2021
Multimeter	Keithley 2000	1160271	02/2020	02/2023
Signal Generator	Rohde & Schwarz SMB	106589	04/2019	04/2022
Amplifier	Aethercomm	SN 046	Characterized prior to test. No cal required.	Characterized prior to test. No cal required.
Power Meter	NI-USB 5680	170100013	05/2019	05/2022
Directional Coupler	Narda 4216-20	01386	Characterized prior to test. No cal required.	Characterized prior to test. No cal required.
Temperature / Humidity Sensor	Testo 184 H1	44220687	05/2020	05/2023



SAR Reference Dipole Calibration Report

Ref : ACR.60.5.21.MVGB.A

SHENZHEN NTEK TESTING TECHNOLOGY CO., LTD.

BUILDING E, FENDA SCIENCE PARK, SANWEI
COMMUNITY, XIXIANG STREET,
BAO'AN DISTRICT, SHENZHEN GUANGDONG, CHINA

MVG COMOSAR REFERENCE DIPOLE

FREQUENCY: 1800 MHZ

SERIAL NO.: SN 03/15 DIP1G800-349

Calibrated at MVG

Z.I. de la pointe du diable

Technopôle Brest Iroise – 295 avenue Alexis de Rochon

29280 PLOUZANE - FRANCE

Calibration date: 03/01/2021



Accreditations #2-6789 and #2-6814
Scope available on www.cofrac.fr

Summary:

This document presents the method and results from an accredited SAR reference dipole calibration performed at MVG, using the COMOSAR test bench. The test results covered by accreditation are traceable to the International System of Units (SI).



SAR REFERENCE DIPOLE CALIBRATION REPORT

Ref. ACR.60.5.21.MVGB.A

	<i>Name</i>	<i>Function</i>	<i>Date</i>	<i>Signature</i>
<i>Prepared by :</i>	Jérôme Luc	Technical Manager	3/1/2021	<i>JL</i>
<i>Checked by :</i>	Jérôme Luc	Technical Manager	3/1/2021	<i>JL</i>
<i>Approved by :</i>	Yann Toutain	Laboratory Director	3/1/2021	<i>Yann Toutain</i>

Made in France 2021.03.0
1 13:10:48
+01'00'

	<i>Customer Name</i>
<i>Distribution :</i>	SHENZHEN NTEK TESTING TECHNOLOGY CO., LTD.

<i>Issue</i>	<i>Name</i>	<i>Date</i>	<i>Modifications</i>
A	Jérôme Luc	3/1/2021	Initial release



SAR REFERENCE DIPOLE CALIBRATION REPORT

Ref. ACR.60.5.21.MVGB.A

TABLE OF CONTENTS

1	Introduction.....	4
2	Device Under Test	4
3	Product Description	4
3.1	General Information	4
4	Measurement Method	5
4.1	Return Loss Requirements	5
4.2	Mechanical Requirements	5
5	Measurement Uncertainty.....	5
5.1	Return Loss	5
5.2	Dimension Measurement	5
5.3	Validation Measurement	5
6	Calibration Measurement Results.....	6
6.1	Return Loss and Impedance	6
6.2	Mechanical Dimensions	6
7	Validation measurement	7
7.1	Measurement Condition	7
7.2	Head Liquid Measurement	7
7.3	Measurement Result	8
8	List of Equipment	10



SAR REFERENCE DIPOLE CALIBRATION REPORT

Ref. ACR.60.5.21.MVGB.A

1 INTRODUCTION

This document contains a summary of the requirements set forth by the IEEE 1528, FCC KDBs and CEI/IEC 62209 standards for reference dipoles used for SAR measurement system validations and the measurements that were performed to verify that the product complies with the fore mentioned standards.

2 DEVICE UNDER TEST

Device Under Test	
Device Type	COMOSAR 1800 MHz REFERENCE DIPOLE
Manufacturer	MVG
Model	SID1800
Serial Number	SN 03/15 DIP1G800-349
Product Condition (new / used)	Used

3 PRODUCT DESCRIPTION

3.1 GENERAL INFORMATION

MVG’s COMOSAR Validation Dipoles are built in accordance to the IEEE 1528, FCC KDBs and CEI/IEC 62209 standards. The product is designed for use with the COMOSAR test bench only.



Figure 1 – MVG COMOSAR Validation Dipole



SAR REFERENCE DIPOLE CALIBRATION REPORT

Ref. ACR.60.5.21.MVGB.A

4 MEASUREMENT METHOD

The IEEE 1528, FCC KDBs and CEI/IEC 62209 standards provide requirements for reference dipoles used for system validation measurements. The following measurements were performed to verify that the product complies with the fore mentioned standards.

4.1 RETURN LOSS REQUIREMENTS

The dipole used for SAR system validation measurements and checks must have a return loss of -20 dB or better. The return loss measurement shall be performed against a liquid filled flat phantom, with the phantom constructed as outlined in the fore mentioned standards. A direct method is used with a network analyser and its calibration kit, both with a valid ISO17025 calibration.

4.2 MECHANICAL REQUIREMENTS

The IEEE Std. 1528 and CEI/IEC 62209 standards specify the mechanical components and dimensions of the validation dipoles, with the dimension's frequency and phantom shell thickness dependent. The COMOSAR test bench employs a 2 mm phantom shell thickness therefore the dipoles sold for use with the COMOSAR test bench comply with the requirements set forth for a 2 mm phantom shell thickness. A direct method is used with a ISO17025 calibrated caliper.

5 MEASUREMENT UNCERTAINTY

All uncertainties listed below represent an expanded uncertainty expressed at approximately the 95% confidence level using a coverage factor of k=2, traceable to the Internationally Accepted Guides to Measurement Uncertainty.

5.1 RETURN LOSS

The following uncertainties apply to the return loss measurement:

Frequency band	Expanded Uncertainty on Return Loss
400-6000MHz	0.08 LIN

5.2 DIMENSION MEASUREMENT

The following uncertainties apply to the dimension measurements:

Length (mm)	Expanded Uncertainty on Length
0 - 300	0.20 mm
300 - 450	0.44 mm

5.3 VALIDATION MEASUREMENT

The guidelines outlined in the IEEE 1528, FCC KDBs, CENELEC EN50361 and CEI/IEC 62209 standards were followed to generate the measurement uncertainty for validation measurements.

Scan Volume	Expanded Uncertainty



SAR REFERENCE DIPOLE CALIBRATION REPORT

Ref. ACR.60.5.21.MVGB.A

1 g	19 % (SAR)
10 g	19 % (SAR)

6 CALIBRATION MEASUREMENT RESULTS

6.1 RETURN LOSS AND IMPEDANCE

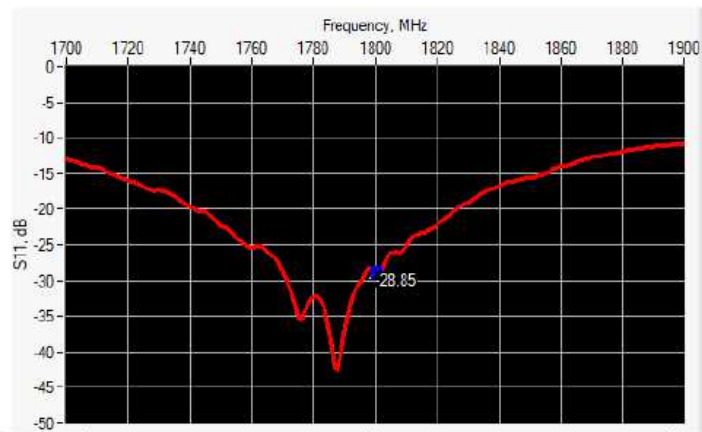

Frequency (MHz)	Return Loss (dB)	Requirement (dB)	Impedance
1800	-28.85	-20	47.9 Ω + 2.9 jΩ

6.2 MECHANICAL DIMENSIONS

Frequency MHz	L mm		h mm		d mm	
	required	measured	required	measured	required	measured
300	420.0 ±1 %.		250.0 ±1 %.		6.35 ±1 %.	
450	290.0 ±1 %.		166.7 ±1 %.		6.35 ±1 %.	
750	176.0 ±1 %.		100.0 ±1 %.		6.35 ±1 %.	
835	161.0 ±1 %.		89.8 ±1 %.		3.6 ±1 %.	
900	149.0 ±1 %.		83.3 ±1 %.		3.6 ±1 %.	
1450	89.1 ±1 %.		51.7 ±1 %.		3.6 ±1 %.	
1500	80.5 ±1 %.		50.0 ±1 %.		3.6 ±1 %.	
1640	79.0 ±1 %.		45.7 ±1 %.		3.6 ±1 %.	
1750	75.2 ±1 %.		42.9 ±1 %.		3.6 ±1 %.	
1800	72.0 ±1 %.	-	41.7 ±1 %.	-	3.6 ±1 %.	-
1900	68.0 ±1 %.		39.5 ±1 %.		3.6 ±1 %.	
1950	66.3 ±1 %.		38.5 ±1 %.		3.6 ±1 %.	
2000	64.5 ±1 %.		37.5 ±1 %.		3.6 ±1 %.	
2100	61.0 ±1 %.		35.7 ±1 %.		3.6 ±1 %.	
2300	55.5 ±1 %.		32.6 ±1 %.		3.6 ±1 %.	
2450	51.5 ±1 %.		30.4 ±1 %.		3.6 ±1 %.	



SAR REFERENCE DIPOLE CALIBRATION REPORT

Ref. ACR.60.5.21.MVGB.A

2600	48.5 ±1 %.		28.8 ±1 %.		3.6 ±1 %.	
3000	41.5 ±1 %.		25.0 ±1 %.		3.6 ±1 %.	
3500	37.0±1 %.		26.4 ±1 %.		3.6 ±1 %.	
3700	34.7±1 %.		26.4 ±1 %.		3.6 ±1 %.	

7 VALIDATION MEASUREMENT

The IEEE Std. 1528, FCC KDBs and CEI/IEC 62209 standards state that the system validation measurements must be performed using a reference dipole meeting the fore mentioned return loss and mechanical dimension requirements. The validation measurement must be performed against a liquid filled flat phantom, with the phantom constructed as outlined in the fore mentioned standards. Per the standards, the dipole shall be positioned below the bottom of the phantom, with the dipole length centered and parallel to the longest dimension of the flat phantom, with the top surface of the dipole at the described distance from the bottom surface of the phantom.

7.1 MEASUREMENT CONDITION

Software	OPENSAR V5
Phantom	SN 13/09 SAM68
Probe	SN 41/18 EPGO333
Liquid	Head Liquid Values: eps' : 43.7 sigma : 1.34
Distance between dipole center and liquid	10.0 mm
Area scan resolution	dx=8mm/dy=8mm
Zoon Scan Resolution	dx=8mm/dy=8mm/dz=5mm
Frequency	18001800 MHz
Input power	20 dBm
Liquid Temperature	20 +/- 1 °C
Lab Temperature	20 +/- 1 °C
Lab Humidity	30-70 %

7.2 HEAD LIQUID MEASUREMENT

Frequency MHz	Relative permittivity (ε _r)		Conductivity (σ) S/m	
	required	measured	required	measured
300	45.3 ±10 %		0.87 ±10 %	
450	43.5 ±10 %		0.87 ±10 %	
750	41.9 ±10 %		0.89 ±10 %	
835	41.5 ±10 %		0.90 ±10 %	
900	41.5 ±10 %		0.97 ±10 %	
1450	40.5 ±10 %		1.20 ±10 %	
1500	40.4 ±10 %		1.23 ±10 %	
1640	40.2 ±10 %		1.31 ±10 %	
1750	40.1 ±10 %		1.37 ±10 %	
1800	40.0 ±10 %	43.7	1.40 ±10 %	1.34
1900	40.0 ±10 %		1.40 ±10 %	
1950	40.0 ±10 %		1.40 ±10 %	
2000	40.0 ±10 %		1.40 ±10 %	



SAR REFERENCE DIPOLE CALIBRATION REPORT

Ref: ACR.60.5.21.MVGB.A

2100	39.8 ±10 %		1.49 ±10 %	
2300	39.5 ±10 %		1.67 ±10 %	
2450	39.2 ±10 %		1.80 ±10 %	
2600	39.0 ±10 %		1.96 ±10 %	
3000	38.5 ±10 %		2.40 ±10 %	
3500	37.9 ±10 %		2.91 ±10 %	

7.3 MEASUREMENT RESULT

The IEEE Std. 1528 and CEI/IEC 62209 standards state that the system validation measurements should produce the SAR values shown below (for phantom thickness of 2 mm), within the uncertainty for the system validation. All SAR values are normalized to 1 W forward power. In bracket, the measured SAR is given with the used input power.

Frequency MHz	1 g SAR (W/kg/W)		10 g SAR (W/kg/W)	
	required	measured	required	measured
300	2.85		1.94	
450	4.58		3.06	
750	8.49		5.55	
835	9.56		6.22	
900	10.9		6.99	
1450	29		16	
1500	30.5		16.8	
1640	34.2		18.4	
1750	36.4		19.3	
1800	38.4	37.96 (3.80)	20.1	19.81 (1.98)
1900	39.7		20.5	
1950	40.5		20.9	
2000	41.1		21.1	
2100	43.6		21.9	
2300	48.7		23.3	
2450	52.4		24	
2600	55.3		24.6	
3000	63.8		25.7	
3500	67.1		25	



SAR REFERENCE DIPOLE CALIBRATION REPORT

Ref: ACR.60.5.21.MVGB.A

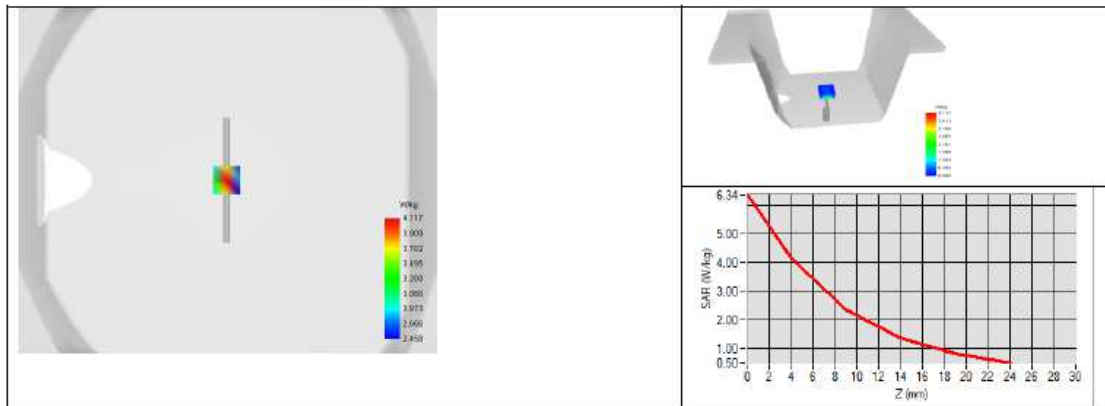



SAR REFERENCE DIPOLE CALIBRATION REPORT

Ref: ACR.60.5.21.MVGB.A

8 LIST OF EQUIPMENT

Equipment Summary Sheet				
Equipment Description	Manufacturer / Model	Identification No.	Current Calibration Date	Next Calibration Date
SAM Phantom	MVG	SN-13/09-SAM68	Validated. No cal required.	Validated. No cal required.
COMOSAR Test Bench	Version 3	NA	Validated. No cal required.	Validated. No cal required.
Network Analyzer	Rohde & Schwarz ZVM	100203	05/2019	05/2022
Network Analyzer – Calibration kit	Rohde & Schwarz ZV-Z235	101223	05/2019	05/2022
Calipers	Mitutoyo	SN 0009732	10/2019	10/2022
Reference Probe	MVG	EPGO333 SN 41/18	05/2020	05/2021
Multimeter	Keithley 2000	1160271	02/2020	02/2023
Signal Generator	Rohde & Schwarz SMB	106589	04/2019	04/2022
Amplifier	Aethercomm	SN 046	Characterized prior to test. No cal required.	Characterized prior to test. No cal required.
Power Meter	NI-USB 5680	170100013	05/2019	05/2022
Directional Coupler	Narda 4216-20	01386	Characterized prior to test. No cal required.	Characterized prior to test. No cal required.
Temperature / Humidity Sensor	Testo 184 H1	44220687	05/2020	05/2023



SAR Reference Dipole Calibration Report

Ref: ACR.60.7.21.MVGB.A

SHENZHEN NTEK TESTING TECHNOLOGY CO., LTD.

BUILDING E, FENDA SCIENCE PARK, SANWEI
COMMUNITY, XIXIANG STREET,
BAO'AN DISTRICT, SHENZHEN GUANGDONG, CHINA

MVG COMOSAR REFERENCE DIPOLE

FREQUENCY: 2000 MHZ

SERIAL NO.: SN 03/15 DIP2G000-351

Calibrated at MVG

Z.I. de la pointe du diable

Technopôle Brest Iroise – 295 avenue Alexis de Rochon
29280 PLOUZANE - FRANCE

Calibration date: 03/01/2021



Accreditations #2-6789 and #2-6814
Scope available on www.cofrac.fr

Summary:

This document presents the method and results from an accredited SAR reference dipole calibration performed at MVG, using the COMOSAR test bench. The test results covered by accreditation are traceable to the International System of Units (SI).



SAR REFERENCE DIPOLE CALIBRATION REPORT

Ref: ACR.60.7.21.MVGB.A

	Name	Function	Date	Signature
Prepared by :	Jérôme Luc	Technical Manager	3/1/2021	<i>JL</i>
Checked by :	Jérôme Luc	Technical Manager	3/1/2021	<i>JL</i>
Approved by :	Yann Toutain	Laboratory Director	3/1/2021	<i>Yann Toutain</i>

2021.03.01 13:12:43 +01'00'

	Customer Name
Distribution :	SHENZHEN NTEK TESTING TECHNOLOGY CO., LTD.

Issue	Name	Date	Modifications
A	Jérôme Luc	3/1/2021	Initial release



SAR REFERENCE DIPOLE CALIBRATION REPORT

Ref: ACR.60.7.21.MVGB.A

TABLE OF CONTENTS

1	Introduction.....	4
2	Device Under Test	4
3	Product Description	4
3.1	General Information	4
4	Measurement Method	5
4.1	Return Loss Requirements	5
4.2	Mechanical Requirements	5
5	Measurement Uncertainty.....	5
5.1	Return Loss	5
5.2	Dimension Measurement	5
5.3	Validation Measurement	5
6	Calibration Measurement Results.....	6
6.1	Return Loss and Impedance	6
6.2	Mechanical Dimensions	6
7	Validation measurement	7
7.1	Measurement Condition	7
7.2	Head Liquid Measurement	7
7.3	Measurement Result	8
8	List of Equipment	10



SAR REFERENCE DIPOLE CALIBRATION REPORT

Ref. ACR.60.7.21.MVGB.A

1 INTRODUCTION

This document contains a summary of the requirements set forth by the IEEE 1528, FCC KDBs and CEI/IEC 62209 standards for reference dipoles used for SAR measurement system validations and the measurements that were performed to verify that the product complies with the fore mentioned standards.

2 DEVICE UNDER TEST

Device Under Test	
Device Type	COMOSAR 2000 MHz REFERENCE DIPOLE
Manufacturer	MVG
Model	SID2000
Serial Number	SN 03/15 DIP2G000-351
Product Condition (new / used)	Used

3 PRODUCT DESCRIPTION

3.1 GENERAL INFORMATION

MVG’s COMOSAR Validation Dipoles are built in accordance to the IEEE 1528, FCC KDBs and CEI/IEC 62209 standards. The product is designed for use with the COMOSAR test bench only.



Figure 1 – MVG COMOSAR Validation Dipole



SAR REFERENCE DIPOLE CALIBRATION REPORT

Ref: ACR.60.7.21.MVGB.A

4 MEASUREMENT METHOD

The IEEE 1528, FCC KDBs and CEI/IEC 62209 standards provide requirements for reference dipoles used for system validation measurements. The following measurements were performed to verify that the product complies with the fore mentioned standards.

4.1 RETURN LOSS REQUIREMENTS

The dipole used for SAR system validation measurements and checks must have a return loss of -20 dB or better. The return loss measurement shall be performed against a liquid filled flat phantom, with the phantom constructed as outlined in the fore mentioned standards. A direct method is used with a network analyser and its calibration kit, both with a valid ISO17025 calibration.

4.2 MECHANICAL REQUIREMENTS

The IEEE Std. 1528 and CEI/IEC 62209 standards specify the mechanical components and dimensions of the validation dipoles, with the dimension's frequency and phantom shell thickness dependent. The COMOSAR test bench employs a 2 mm phantom shell thickness therefore the dipoles sold for use with the COMOSAR test bench comply with the requirements set forth for a 2 mm phantom shell thickness. A direct method is used with a ISO17025 calibrated caliper.

5 MEASUREMENT UNCERTAINTY

All uncertainties listed below represent an expanded uncertainty expressed at approximately the 95% confidence level using a coverage factor of k=2, traceable to the Internationally Accepted Guides to Measurement Uncertainty.

5.1 RETURN LOSS

The following uncertainties apply to the return loss measurement:

Frequency band	Expanded Uncertainty on Return Loss
400-6000MHz	0.08 LIN

5.2 DIMENSION MEASUREMENT

The following uncertainties apply to the dimension measurements:

Length (mm)	Expanded Uncertainty on Length
0 - 300	0.20 mm
300 - 450	0.44 mm

5.3 VALIDATION MEASUREMENT

The guidelines outlined in the IEEE 1528, FCC KDBs, CENELEC EN50361 and CEI/IEC 62209 standards were followed to generate the measurement uncertainty for validation measurements.

Scan Volume	Expanded Uncertainty



SAR REFERENCE DIPOLE CALIBRATION REPORT

Ref: ACR.60.7.21.MVGB.A

1 g	19 % (SAR)
10 g	19 % (SAR)

6 CALIBRATION MEASUREMENT RESULTS

6.1 RETURN LOSS AND IMPEDANCE

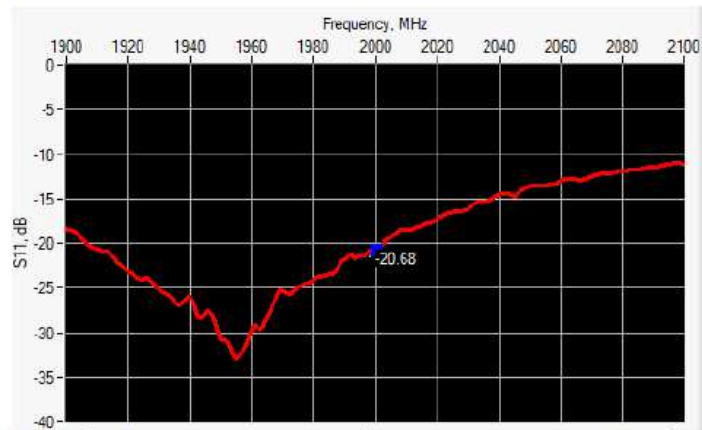

Frequency (MHz)	Return Loss (dB)	Requirement (dB)	Impedance
2000	-20.68	-20	60.3 Ω + 0.1 jΩ

6.2 MECHANICAL DIMENSIONS

Frequency MHz	L mm		h mm		d mm	
	required	measured	required	measured	required	measured
300	420.0 ±1 %.		250.0 ±1 %.		6.35 ±1 %.	
450	290.0 ±1 %.		166.7 ±1 %.		6.35 ±1 %.	
750	176.0 ±1 %.		100.0 ±1 %.		6.35 ±1 %.	
835	161.0 ±1 %.		89.8 ±1 %.		3.6 ±1 %.	
900	149.0 ±1 %.		83.3 ±1 %.		3.6 ±1 %.	
1450	89.1 ±1 %.		51.7 ±1 %.		3.6 ±1 %.	
1500	80.5 ±1 %.		50.0 ±1 %.		3.6 ±1 %.	
1640	79.0 ±1 %.		45.7 ±1 %.		3.6 ±1 %.	
1750	75.2 ±1 %.		42.9 ±1 %.		3.6 ±1 %.	
1800	72.0 ±1 %.		41.7 ±1 %.		3.6 ±1 %.	
1900	68.0 ±1 %.		39.5 ±1 %.		3.6 ±1 %.	
1950	66.3 ±1 %.		38.5 ±1 %.		3.6 ±1 %.	
2000	64.5 ±1 %.	-	37.5 ±1 %.	-	3.6 ±1 %.	-
2100	61.0 ±1 %.		35.7 ±1 %.		3.6 ±1 %.	
2300	55.5 ±1 %.		32.6 ±1 %.		3.6 ±1 %.	
2450	51.5 ±1 %.		30.4 ±1 %.		3.6 ±1 %.	



SAR REFERENCE DIPOLE CALIBRATION REPORT

Ref: ACR.60.7.21.MVGB.A

2600	48.5 ±1 %.		28.8 ±1 %.		3.6 ±1 %.	
3000	41.5 ±1 %.		25.0 ±1 %.		3.6 ±1 %.	
3500	37.0±1 %.		26.4 ±1 %.		3.6 ±1 %.	
3700	34.7±1 %.		26.4 ±1 %.		3.6 ±1 %.	

7 VALIDATION MEASUREMENT

The IEEE Std. 1528, FCC KDBs and CEI/IEC 62209 standards state that the system validation measurements must be performed using a reference dipole meeting the fore mentioned return loss and mechanical dimension requirements. The validation measurement must be performed against a liquid filled flat phantom, with the phantom constructed as outlined in the fore mentioned standards. Per the standards, the dipole shall be positioned below the bottom of the phantom, with the dipole length centered and parallel to the longest dimension of the flat phantom, with the top surface of the dipole at the described distance from the bottom surface of the phantom.

7.1 MEASUREMENT CONDITION

Software	OPENSAR V5
Phantom	SN 13/09 SAM68
Probe	SN 41/18 EPGO333
Liquid	Head Liquid Values: eps' : 43.1 sigma : 1.48
Distance between dipole center and liquid	10.0 mm
Area scan resolution	dx=8mm/dy=8mm
Zoon Scan Resolution	dx=5mm/dy=5mm/dz=5mm
Frequency	20002000 MHz
Input power	20 dBm
Liquid Temperature	20 +/- 1 °C
Lab Temperature	20 +/- 1 °C
Lab Humidity	30-70 %

7.2 HEAD LIQUID MEASUREMENT

Frequency MHz	Relative permittivity (ε _r)		Conductivity (σ) S/m	
	required	measured	required	measured
300	45.3 ±10 %		0.87 ±10 %	
450	43.5 ±10 %		0.87 ±10 %	
750	41.9 ±10 %		0.89 ±10 %	
835	41.5 ±10 %		0.90 ±10 %	
900	41.5 ±10 %		0.97 ±10 %	
1450	40.5 ±10 %		1.20 ±10 %	
1500	40.4 ±10 %		1.23 ±10 %	
1640	40.2 ±10 %		1.31 ±10 %	
1750	40.1 ±10 %		1.37 ±10 %	
1800	40.0 ±10 %		1.40 ±10 %	
1900	40.0 ±10 %		1.40 ±10 %	
1950	40.0 ±10 %		1.40 ±10 %	
2000	40.0 ±10 %	43.1	1.40 ±10 %	1.48



SAR REFERENCE DIPOLE CALIBRATION REPORT

Ref: ACR.60.7.21.MVGB.A

2100	39.8 ±10 %		1.49 ±10 %	
2300	39.5 ±10 %		1.67 ±10 %	
2450	39.2 ±10 %		1.80 ±10 %	
2600	39.0 ±10 %		1.96 ±10 %	
3000	38.5 ±10 %		2.40 ±10 %	
3500	37.9 ±10 %		2.91 ±10 %	

7.3 MEASUREMENT RESULT

The IEEE Std. 1528 and CEI/IEC 62209 standards state that the system validation measurements should produce the SAR values shown below (for phantom thickness of 2 mm), within the uncertainty for the system validation. All SAR values are normalized to 1 W forward power. In bracket, the measured SAR is given with the used input power.

Frequency MHz	1 g SAR (W/kg/W)		10 g SAR (W/kg/W)	
	required	measured	required	measured
300	2.85		1.94	
450	4.58		3.06	
750	8.49		5.55	
835	9.56		6.22	
900	10.9		6.99	
1450	29		16	
1500	30.5		16.8	
1640	34.2		18.4	
1750	36.4		19.3	
1800	38.4		20.1	
1900	39.7		20.5	
1950	40.5		20.9	
2000	41.1	41.26 (4.13)	21.1	20.52 (2.05)
2100	43.6		21.9	
2300	48.7		23.3	
2450	52.4		24	
2600	55.3		24.6	
3000	63.8		25.7	
3500	67.1		25	



SAR REFERENCE DIPOLE CALIBRATION REPORT

Ref. ACR.60.7.21.MVGB.A

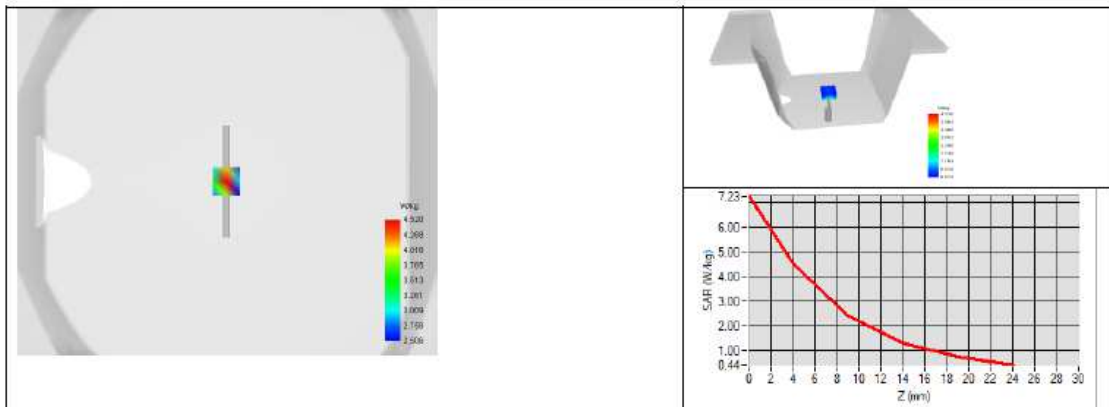



SAR REFERENCE DIPOLE CALIBRATION REPORT

Ref. ACR.60.7.21.MVGB.A

8 LIST OF EQUIPMENT

Equipment Summary Sheet				
Equipment Description	Manufacturer / Model	Identification No.	Current Calibration Date	Next Calibration Date
SAM Phantom	MVG	SN-13/09-SAM68	Validated. No cal required.	Validated. No cal required.
COMOSAR Test Bench	Version 3	NA	Validated. No cal required.	Validated. No cal required.
Network Analyzer	Rohde & Schwarz ZVM	100203	05/2019	05/2022
Network Analyzer – Calibration kit	Rohde & Schwarz ZV-Z235	101223	05/2019	05/2022
Calipers	Mitutoyo	SN 0009732	10/2019	10/2022
Reference Probe	MVG	EPGO333 SN 41/18	05/2020	05/2021
Multimeter	Keithley 2000	1160271	02/2020	02/2023
Signal Generator	Rohde & Schwarz SMB	106589	04/2019	04/2022
Amplifier	Aethercomm	SN 046	Characterized prior to test. No cal required.	Characterized prior to test. No cal required.
Power Meter	NI-USB 5680	170100013	05/2019	05/2022
Directional Coupler	Narda 4216-20	01386	Characterized prior to test. No cal required.	Characterized prior to test. No cal required.
Temperature / Humidity Sensor	Testo 184 H1	44220687	05/2020	05/2023



SAR Reference Dipole Calibration Report

Ref : ACR.60.11.21.MVGB.A

SHENZHEN NTEK TESTING TECHNOLOGY CO., LTD.

BUILDING E, FENDA SCIENCE PARK, SANWEI
COMMUNITY, XIXIANG STREET,
BAO'AN DISTRICT, SHENZHEN GUANGDONG, CHINA

MVG COMOSAR REFERENCE DIPOLE

FREQUENCY: 2300 MHZ

SERIAL NO.: SN 03/16 DIP2G300-358

Calibrated at MVG

Z.I. de la pointe du diable

Technopôle Brest Iroise – 295 avenue Alexis de Rochon
29280 PLOUZANE - FRANCE

Calibration date: 03/01/2021



Accreditations #2-6789 and #2-6814
Scope available on www.cofrac.fr

Summary:

This document presents the method and results from an accredited SAR reference dipole calibration performed at MVG, using the COMOSAR test bench. The test results covered by accreditation are traceable to the International System of Units (SI).



SAR REFERENCE DIPOLE CALIBRATION REPORT

Ref: ACR.60.11.21.MVGB.A

	<i>Name</i>	<i>Function</i>	<i>Date</i>	<i>Signature</i>
<i>Prepared by :</i>	Jérôme LUC	Technical Manager	3/1/2021	<i>JLS</i>
<i>Checked by :</i>	Jérôme LUC	Technical Manager	3/1/2021	<i>JLS</i>
<i>Approved by :</i>	Yann Toutain	Laboratory Director	3/1/2021	<i>Yann Toutain</i>

Mode d'emploi
2021.03.0
1 13:16:13
+01'00'

PHILIPS

	<i>Customer Name</i>
<i>Distribution :</i>	SHENZHEN NTEK TESTING TECHNOLOGY CO., LTD.

<i>Issue</i>	<i>Name</i>	<i>Date</i>	<i>Modifications</i>
A	Jérôme LE GALL	3/1/2021	Initial release



SAR REFERENCE DIPOLE CALIBRATION REPORT

Ref. ACR.60.11.21.MVGB.A

TABLE OF CONTENTS

1	Introduction.....	4
2	Device Under Test	4
3	Product Description	4
3.1	General Information	4
4	Measurement Method	5
4.1	Return Loss Requirements	5
4.2	Mechanical Requirements	5
5	Measurement Uncertainty.....	5
5.1	Return Loss	5
5.2	Dimension Measurement	5
5.3	Validation Measurement	5
6	Calibration Measurement Results.....	6
6.1	Return Loss and Impedance	6
6.2	Mechanical Dimensions	6
7	Validation measurement	7
7.1	Measurement Condition	7
7.2	Head Liquid Measurement	7
7.3	Measurement Result	8
8	List of Equipment	10



SAR REFERENCE DIPOLE CALIBRATION REPORT

Ref. ACR.60.11.21.MVGB.A

1 INTRODUCTION

This document contains a summary of the requirements set forth by the IEEE 1528, FCC KDBs and CEI/IEC 62209 standards for reference dipoles used for SAR measurement system validations and the measurements that were performed to verify that the product complies with the fore mentioned standards.

2 DEVICE UNDER TEST

Device Under Test	
Device Type	COMOSAR 2300 MHz REFERENCE DIPOLE
Manufacturer	MVG
Model	SID2300
Serial Number	SN 03/15 DIP2G300-358
Product Condition (new / used)	Used

3 PRODUCT DESCRIPTION

3.1 GENERAL INFORMATION

MVG’s COMOSAR Validation Dipoles are built in accordance to the IEEE 1528, FCC KDBs and CEI/IEC 62209 standards. The product is designed for use with the COMOSAR test bench only.



Figure 1 – MVG COMOSAR Validation Dipole



SAR REFERENCE DIPOLE CALIBRATION REPORT

Ref. ACR.60.11.21.MVGB.A

4 MEASUREMENT METHOD

The IEEE 1528, FCC KDBs and CEI/IEC 62209 standards provide requirements for reference dipoles used for system validation measurements. The following measurements were performed to verify that the product complies with the fore mentioned standards.

4.1 RETURN LOSS REQUIREMENTS

The dipole used for SAR system validation measurements and checks must have a return loss of -20 dB or better. The return loss measurement shall be performed against a liquid filled flat phantom, with the phantom constructed as outlined in the fore mentioned standards. A direct method is used with a network analyser and its calibration kit, both with a valid ISO17025 calibration.

4.2 MECHANICAL REQUIREMENTS

The IEEE Std. 1528 and CEI/IEC 62209 standards specify the mechanical components and dimensions of the validation dipoles, with the dimension's frequency and phantom shell thickness dependent. The COMOSAR test bench employs a 2 mm phantom shell thickness therefore the dipoles sold for use with the COMOSAR test bench comply with the requirements set forth for a 2 mm phantom shell thickness. A direct method is used with a ISO17025 calibrated caliper.

5 MEASUREMENT UNCERTAINTY

All uncertainties listed below represent an expanded uncertainty expressed at approximately the 95% confidence level using a coverage factor of k=2, traceable to the Internationally Accepted Guides to Measurement Uncertainty.

5.1 RETURN LOSS

The following uncertainties apply to the return loss measurement:

Frequency band	Expanded Uncertainty on Return Loss
400-6000MHz	0.08 LIN

5.2 DIMENSION MEASUREMENT

The following uncertainties apply to the dimension measurements:

Length (mm)	Expanded Uncertainty on Length
0 - 300	0.20 mm
300 - 450	0.44 mm

5.3 VALIDATION MEASUREMENT

The guidelines outlined in the IEEE 1528, FCC KDBs, CENELEC EN50361 and CEI/IEC 62209 standards were followed to generate the measurement uncertainty for validation measurements.

Scan Volume	Expanded Uncertainty



SAR REFERENCE DIPOLE CALIBRATION REPORT

Ref. ACR.60.11.21.MVGB.A

1 g	19 % (SAR)
10 g	19 % (SAR)

6 CALIBRATION MEASUREMENT RESULTS

6.1 RETURN LOSS AND IMPEDANCE

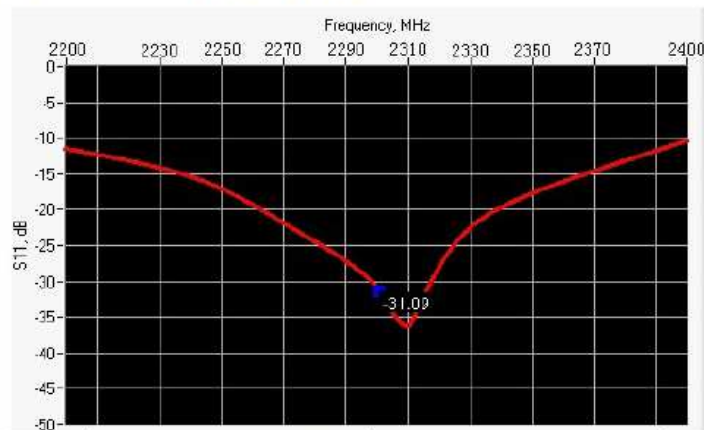

Frequency (MHz)	Return Loss (dB)	Requirement (dB)	Impedance
2300	-31.09	-20	56.3 Ω - 2.9 jΩ

6.2 MECHANICAL DIMENSIONS

Frequency MHz	L mm		h mm		d mm	
	required	measured	required	measured	required	measured
300	420.0 ±1 %.		250.0 ±1 %.		6.35 ±1 %.	
450	290.0 ±1 %.		166.7 ±1 %.		6.35 ±1 %.	
750	176.0 ±1 %.		100.0 ±1 %.		6.35 ±1 %.	
835	161.0 ±1 %.		89.8 ±1 %.		3.6 ±1 %.	
900	149.0 ±1 %.		83.3 ±1 %.		3.6 ±1 %.	
1450	89.1 ±1 %.		51.7 ±1 %.		3.6 ±1 %.	
1500	80.5 ±1 %.		50.0 ±1 %.		3.6 ±1 %.	
1640	79.0 ±1 %.		45.7 ±1 %.		3.6 ±1 %.	
1750	75.2 ±1 %.		42.9 ±1 %.		3.6 ±1 %.	
1800	72.0 ±1 %.		41.7 ±1 %.		3.6 ±1 %.	
1900	68.0 ±1 %.		39.5 ±1 %.		3.6 ±1 %.	
1950	66.3 ±1 %.		38.5 ±1 %.		3.6 ±1 %.	
2000	64.5 ±1 %.		37.5 ±1 %.		3.6 ±1 %.	
2100	61.0 ±1 %.		35.7 ±1 %.		3.6 ±1 %.	
2300	55.5 ±1 %.	-	32.6 ±1 %.	-	3.6 ±1 %.	-
2450	51.5 ±1 %.		30.4 ±1 %.		3.6 ±1 %.	



SAR REFERENCE DIPOLE CALIBRATION REPORT

Ref: ACR.60.11.21.MVGB.A

2600	48.5 ±1 %.		28.8 ±1 %.		3.6 ±1 %.	
3000	41.5 ±1 %.		25.0 ±1 %.		3.6 ±1 %.	
3500	37.0±1 %.		26.4 ±1 %.		3.6 ±1 %.	
3700	34.7±1 %.		26.4 ±1 %.		3.6 ±1 %.	

7 VALIDATION MEASUREMENT

The IEEE Std. 1528, FCC KDBs and CEI/IEC 62209 standards state that the system validation measurements must be performed using a reference dipole meeting the fore mentioned return loss and mechanical dimension requirements. The validation measurement must be performed against a liquid filled flat phantom, with the phantom constructed as outlined in the fore mentioned standards. Per the standards, the dipole shall be positioned below the bottom of the phantom, with the dipole length centered and parallel to the longest dimension of the flat phantom, with the top surface of the dipole at the described distance from the bottom surface of the phantom.

7.1 MEASUREMENT CONDITION

Software	OPENSAR V5
Phantom	SN 13/09 SAM68
Probe	SN 41/18 EPG0333
Liquid	Head Liquid Values: eps' : 42.0 sigma : 1.80
Distance between dipole center and liquid	10.0 mm
Area scan resolution	dx=8mm/dy=8mm
Zoon Scan Resolution	dx=5mm/dy=5mm/dz=5mm
Frequency	23002300 MHz
Input power	20 dBm
Liquid Temperature	20 +/- 1 °C
Lab Temperature	20 +/- 1 °C
Lab Humidity	30-70 %

7.2 HEAD LIQUID MEASUREMENT

Frequency MHz	Relative permittivity (ε _r)		Conductivity (σ) S/m	
	required	measured	required	measured
300	45.3 ±10 %		0.87 ±10 %	
450	43.5 ±10 %		0.87 ±10 %	
750	41.9 ±10 %		0.89 ±10 %	
835	41.5 ±10 %		0.90 ±10 %	
900	41.5 ±10 %		0.97 ±10 %	
1450	40.5 ±10 %		1.20 ±10 %	
1500	40.4 ±10 %		1.23 ±10 %	
1640	40.2 ±10 %		1.31 ±10 %	
1750	40.1 ±10 %		1.37 ±10 %	
1800	40.0 ±10 %		1.40 ±10 %	
1900	40.0 ±10 %		1.40 ±10 %	
1950	40.0 ±10 %		1.40 ±10 %	
2000	40.0 ±10 %		1.40 ±10 %	



SAR REFERENCE DIPOLE CALIBRATION REPORT

Ref. ACR.60.11.21.MVGB.A

2100	39.8 ±10 %		1.49 ±10 %	
2300	39.5 ±10 %	42.2	1.67 ±10 %	1.75
2450	39.2 ±10 %		1.80 ±10 %	
2600	39.0 ±10 %		1.96 ±10 %	
3000	38.5 ±10 %		2.40 ±10 %	
3500	37.9 ±10 %		2.91 ±10 %	

7.3 MEASUREMENT RESULT

The IEEE Std. 1528 and CEI/IEC 62209 standards state that the system validation measurements should produce the SAR values shown below (for phantom thickness of 2 mm), within the uncertainty for the system validation. All SAR values are normalized to 1 W forward power. In bracket, the measured SAR is given with the used input power.

Frequency MHz	1 g SAR (W/kg/W)		10 g SAR (W/kg/W)	
	required	measured	required	measured
300	2.85		1.94	
450	4.58		3.06	
750	8.49		5.55	
835	9.56		6.22	
900	10.9		6.99	
1450	29		16	
1500	30.5		16.8	
1640	34.2		18.4	
1750	36.4		19.3	
1800	38.4		20.1	
1900	39.7		20.5	
1950	40.5		20.9	
2000	41.1		21.1	
2100	43.6		21.9	
2300	48.7	50.65 (5.07)	23.3	23.55 (2.36)
2450	52.4		24	
2600	55.3		24.6	
3000	63.8		25.7	
3500	67.1		25	



SAR REFERENCE DIPOLE CALIBRATION REPORT

Ref: ACR.60.11.21.MVGB.A

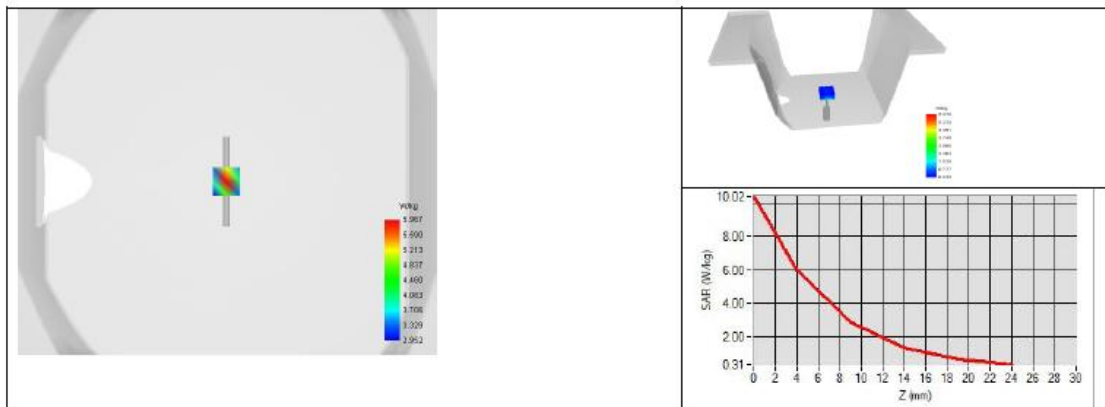



SAR REFERENCE DIPOLE CALIBRATION REPORT

Ref. ACR.60.11.21.MVGB.A

8 LIST OF EQUIPMENT

Equipment Summary Sheet				
Equipment Description	Manufacturer / Model	Identification No.	Current Calibration Date	Next Calibration Date
SAM Phantom	MVG	SN-13/09-SAM68	Validated. No cal required.	Validated. No cal required.
COMOSAR Test Bench	Version 3	NA	Validated. No cal required.	Validated. No cal required.
Network Analyzer	Rohde & Schwarz ZVM	100203	05/2019	05/2022
Network Analyzer – Calibration kit	Rohde & Schwarz ZV-Z235	101223	05/2019	05/2022
Calipers	Mitutoyo	SN 0009732	10/2019	10/2022
Reference Probe	MVG	EPGO333 SN 41/18	05/2020	05/2021
Multimeter	Keithley 2000	1160271	02/2020	02/2023
Signal Generator	Rohde & Schwarz SMB	106589	04/2019	04/2022
Amplifier	Aethercomm	SN 046	Characterized prior to test. No cal required.	Characterized prior to test. No cal required.
Power Meter	NI-USB 5680	170100013	05/2019	05/2022
Directional Coupler	Narda 4216-20	01386	Characterized prior to test. No cal required.	Characterized prior to test. No cal required.
Temperature / Humidity Sensor	Testo 184 H1	44220687	05/2020	05/2023



SAR Reference Dipole Calibration Report

Ref : ACR.60.8.21.MVGB.A

SHENZHEN NTEK TESTING TECHNOLOGY CO., LTD.

BUILDING E, FENDA SCIENCE PARK, SANWEI
COMMUNITY, XIXIANG STREET,
BAO'AN DISTRICT, SHENZHEN GUANGDONG, CHINA
MVG COMOSAR REFERENCE DIPOLE

FREQUENCY: 2450 MHZ

SERIAL NO.: SN 03/15 DIP2G450-352

Calibrated at MVG

Z.I. de la pointe du diable

Technopôle Brest Iroise – 295 avenue Alexis de Rochon
29280 PLOUZANE - FRANCE

Calibration date: 03/01/2021



Accreditations #2-6789 and #2-6814
Scope available on www.cofrac.fr

Summary:

This document presents the method and results from an accredited SAR reference dipole calibration performed at MVG, using the COMOSAR test bench. The test results covered by accreditation are traceable to the International System of Units (SI).



SAR REFERENCE DIPOLE CALIBRATION REPORT

Ref: ACR.60.8.21.MVGB.A

	Name	Function	Date	Signature
Prepared by :	Jérôme LUC	Technical Manager	3/1/2021	<i>JLS</i>
Checked by :	Jérôme LUC	Technical Manager	3/1/2021	<i>JLS</i>
Approved by :	Yann Toutain	Laboratory Director	3/1/2021	<i>Yann Toutain</i>

2021.03.01
13:13:40
+01'00'

	Customer Name
Distribution :	SHENZHEN NTEK TESTING TECHNOLOGY CO., LTD.

Issue	Name	Date	Modifications
A	Jérôme LE GALL	3/1/2021	Initial release



SAR REFERENCE DIPOLE CALIBRATION REPORT

Ref: ACR.60.8.21.MVGB.A

TABLE OF CONTENTS

1	Introduction.....	4
2	Device Under Test.....	4
3	Product Description.....	4
3.1	General Information.....	4
4	Measurement Method.....	5
4.1	Return Loss Requirements.....	5
4.2	Mechanical Requirements.....	5
5	Measurement Uncertainty.....	5
5.1	Return Loss.....	5
5.2	Dimension Measurement.....	5
5.3	Validation Measurement.....	5
6	Calibration Measurement Results.....	6
6.1	Return Loss and Impedance.....	6
6.2	Mechanical Dimensions.....	6
7	Validation measurement.....	7
7.1	Measurement Condition.....	7
7.2	Head Liquid Measurement.....	7
7.3	Measurement Result.....	8
8	List of Equipment.....	10



SAR REFERENCE DIPOLE CALIBRATION REPORT

Ref: ACR.60.8.21.MVGB.A

1 INTRODUCTION

This document contains a summary of the requirements set forth by the IEEE 1528, FCC KDBs and CEI/IEC 62209 standards for reference dipoles used for SAR measurement system validations and the measurements that were performed to verify that the product complies with the fore mentioned standards.

2 DEVICE UNDER TEST

Device Under Test	
Device Type	COMOSAR 2450 MHz REFERENCE DIPOLE
Manufacturer	MVG
Model	SID2450
Serial Number	SN 03/15 DIP2G450-352
Product Condition (new / used)	Used

3 PRODUCT DESCRIPTION

3.1 GENERAL INFORMATION

MVG’s COMOSAR Validation Dipoles are built in accordance to the IEEE 1528, FCC KDBs and CEI/IEC 62209 standards. The product is designed for use with the COMOSAR test bench only.



Figure 1 – MVG COMOSAR Validation Dipole



SAR REFERENCE DIPOLE CALIBRATION REPORT

Ref. ACR.60.8.21.MVGB.A

4 MEASUREMENT METHOD

The IEEE 1528, FCC KDBs and CEI/IEC 62209 standards provide requirements for reference dipoles used for system validation measurements. The following measurements were performed to verify that the product complies with the fore mentioned standards.

4.1 RETURN LOSS REQUIREMENTS

The dipole used for SAR system validation measurements and checks must have a return loss of -20 dB or better. The return loss measurement shall be performed against a liquid filled phantom, with the phantom constructed as outlined in the fore mentioned standards. A direct method is used with a network analyser and its calibration kit, both with a valid ISO17025 calibration.

4.2 MECHANICAL REQUIREMENTS

The IEEE Std. 1528 and CEI/IEC 62209 standards specify the mechanical components and dimensions of the validation dipoles, with the dimension's frequency and phantom shell thickness dependent. The COMOSAR test bench employs a 2 mm phantom shell thickness therefore the dipoles sold for use with the COMOSAR test bench comply with the requirements set forth for a 2 mm phantom shell thickness. A direct method is used with a ISO17025 calibrated caliper.

5 MEASUREMENT UNCERTAINTY

All uncertainties listed below represent an expanded uncertainty expressed at approximately the 95% confidence level using a coverage factor of k=2, traceable to the Internationally Accepted Guides to Measurement Uncertainty.

5.1 RETURN LOSS

The following uncertainties apply to the return loss measurement:

Frequency band	Expanded Uncertainty on Return Loss
400-6000MHz	0.08 LIN

5.2 DIMENSION MEASUREMENT

The following uncertainties apply to the dimension measurements:

Length (mm)	Expanded Uncertainty on Length
0 - 300	0.20 mm
300 - 450	0.44 mm

5.3 VALIDATION MEASUREMENT

The guidelines outlined in the IEEE 1528, FCC KDBs, CENELEC EN50361 and CEI/IEC 62209 standards were followed to generate the measurement uncertainty for validation measurements.

Scan Volume	Expanded Uncertainty



SAR REFERENCE DIPOLE CALIBRATION REPORT

Ref: ACR.60.8.21.MVGB.A

1 g	19 % (SAR)
10 g	19 % (SAR)

6 CALIBRATION MEASUREMENT RESULTS

6.1 RETURN LOSS AND IMPEDANCE

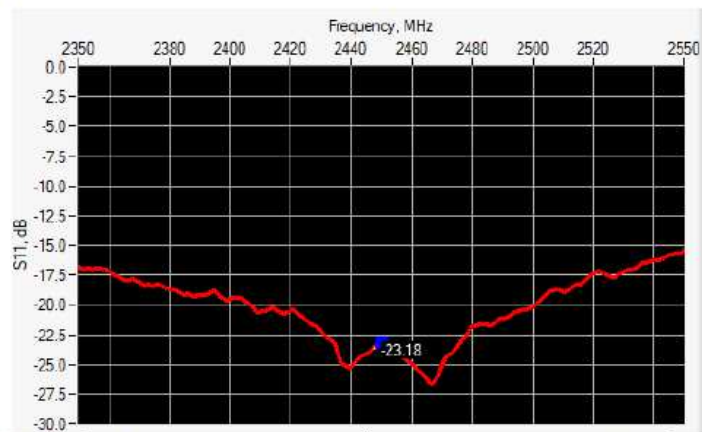

Frequency (MHz)	Return Loss (dB)	Requirement (dB)	Impedance
2450	-23.18	-20	56.3 Ω - 2.9 jΩ

6.2 MECHANICAL DIMENSIONS

Frequency MHz	L mm		h mm		d mm	
	required	measured	required	measured	required	measured
300	420.0 ±1 %		250.0 ±1 %		6.35 ±1 %	
450	290.0 ±1 %		166.7 ±1 %		6.35 ±1 %	
750	176.0 ±1 %		100.0 ±1 %		6.35 ±1 %	
835	161.0 ±1 %		89.8 ±1 %		3.6 ±1 %	
900	149.0 ±1 %		83.3 ±1 %		3.6 ±1 %	
1450	89.1 ±1 %		51.7 ±1 %		3.6 ±1 %	
1500	80.5 ±1 %		50.0 ±1 %		3.6 ±1 %	
1640	79.0 ±1 %		45.7 ±1 %		3.6 ±1 %	
1750	75.2 ±1 %		42.9 ±1 %		3.6 ±1 %	
1800	72.0 ±1 %		41.7 ±1 %		3.6 ±1 %	
1900	68.0 ±1 %		39.5 ±1 %		3.6 ±1 %	
1950	66.3 ±1 %		38.5 ±1 %		3.6 ±1 %	
2000	64.5 ±1 %		37.5 ±1 %		3.6 ±1 %	
2100	61.0 ±1 %		35.7 ±1 %		3.6 ±1 %	
2300	55.5 ±1 %		32.6 ±1 %		3.6 ±1 %	
2450	51.5 ±1 %	-	30.4 ±1 %	-	3.6 ±1 %	-



SAR REFERENCE DIPOLE CALIBRATION REPORT

Ref ACR.60.8.21.MVGB.A

2600	48.5 ±1 %.		28.8 ±1 %.		3.6 ±1 %.	
3000	41.5 ±1 %.		25.0 ±1 %.		3.6 ±1 %.	
3500	37.0±1 %.		26.4 ±1 %.		3.6 ±1 %.	
3700	34.7±1 %.		26.4 ±1 %.		3.6 ±1 %.	

7 VALIDATION MEASUREMENT

The IEEE Std. 1528, FCC KDBs and CEI/IEC 62209 standards state that the system validation measurements must be performed using a reference dipole meeting the fore mentioned return loss and mechanical dimension requirements. The validation measurement must be performed against a liquid filled flat phantom, with the phantom constructed as outlined in the fore mentioned standards. Per the standards, the dipole shall be positioned below the bottom of the phantom, with the dipole length centered and parallel to the longest dimension of the flat phantom, with the top surface of the dipole at the described distance from the bottom surface of the phantom.

7.1 MEASUREMENT CONDITION

Software	OPENSAR V5
Phantom	SN 13/09 SAM68
Probe	SN 41/18 EPGO333
Liquid	Head Liquid Values: eps' : 41.9 sigma : 1.88
Distance between dipole center and liquid	10.0 mm
Area scan resolution	dx=8mm/dy=8mm
Zoon Scan Resolution	dx=5mm/dy=5mm/dz=5mm
Frequency	24502450 MHz
Input power	20 dBm
Liquid Temperature	20 +/- 1 °C
Lab Temperature	20 +/- 1 °C
Lab Humidity	30-70 %

7.2 HEAD LIQUID MEASUREMENT

Frequency MHz	Relative permittivity (ε _r)		Conductivity (σ) S/m	
	required	measured	required	measured
300	45.3 ±10 %		0.87 ±10 %	
450	43.5 ±10 %		0.87 ±10 %	
750	41.9 ±10 %		0.89 ±10 %	
835	41.5 ±10 %		0.90 ±10 %	
900	41.5 ±10 %		0.97 ±10 %	
1450	40.5 ±10 %		1.20 ±10 %	
1500	40.4 ±10 %		1.23 ±10 %	
1640	40.2 ±10 %		1.31 ±10 %	
1750	40.1 ±10 %		1.37 ±10 %	
1800	40.0 ±10 %		1.40 ±10 %	
1900	40.0 ±10 %		1.40 ±10 %	
1950	40.0 ±10 %		1.40 ±10 %	
2000	40.0 ±10 %		1.40 ±10 %	



SAR REFERENCE DIPOLE CALIBRATION REPORT

Ref: ACR.60.8.21.MVGB.A

2100	39.8 ±10 %		1.49 ±10 %	
2300	39.5 ±10 %		1.67 ±10 %	
2450	39.2 ±10 %	41.9	1.80 ±10 %	1.88
2600	39.0 ±10 %		1.96 ±10 %	
3000	38.5 ±10 %		2.40 ±10 %	
3500	37.9 ±10 %		2.91 ±10 %	

7.3 MEASUREMENT RESULT

The IEEE Std. 1528 and CEI/IEC 62209 standards state that the system validation measurements should produce the SAR values shown below (for phantom thickness of 2 mm), within the uncertainty for the system validation. All SAR values are normalized to 1 W forward power. In bracket, the measured SAR is given with the used input power.

Frequency MHz	1 g SAR (W/kg/W)		10 g SAR (W/kg/W)	
	required	measured	required	measured
300	2.85		1.94	
450	4.58		3.06	
750	8.49		5.55	
835	9.56		6.22	
900	10.9		6.99	
1450	29		16	
1500	30.5		16.8	
1640	34.2		18.4	
1750	36.4		19.3	
1800	38.4		20.1	
1900	39.7		20.5	
1950	40.5		20.9	
2000	41.1		21.1	
2100	43.6		21.9	
2300	48.7		23.3	
2450	52.4	53.69 (5.37)	24	23.94 (2.39)
2600	55.3		24.6	
3000	63.8		25.7	
3500	67.1		25	



SAR REFERENCE DIPOLE CALIBRATION REPORT

Ref: ACR.60.8.21.MVGB.A

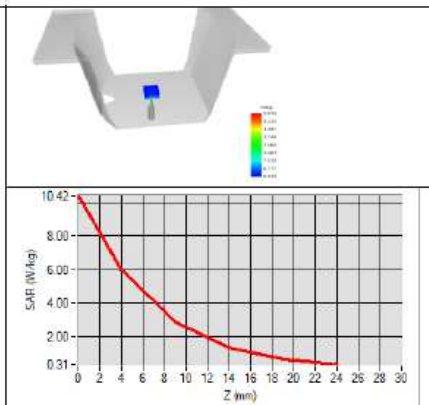
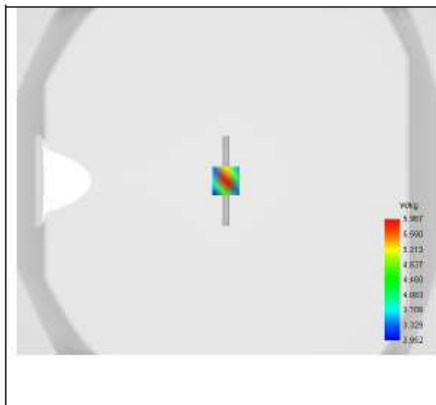



SAR REFERENCE DIPOLE CALIBRATION REPORT

Ref: ACR.60.8.21.MVGB.A

8 LIST OF EQUIPMENT

Equipment Summary Sheet				
Equipment Description	Manufacturer / Model	Identification No.	Current Calibration Date	Next Calibration Date
SAM Phantom	MVG	SN-13/09-SAM68	Validated. No cal required.	Validated. No cal required.
COMOSAR Test Bench	Version 3	NA	Validated. No cal required.	Validated. No cal required.
Network Analyzer	Rohde & Schwarz ZVM	100203	05/2019	05/2022
Network Analyzer – Calibration kit	Rohde & Schwarz ZV-Z235	101223	05/2019	05/2022
Calipers	Mitutoyo	SN 0009732	10/2019	10/2022
Reference Probe	MVG	EPGO333 SN 41/18	05/2020	05/2021
Multimeter	Keithley 2000	1160271	02/2020	02/2023
Signal Generator	Rohde & Schwarz SMB	106589	04/2019	04/2022
Amplifier	Aethercomm	SN 046	Characterized prior to test. No cal required.	Characterized prior to test. No cal required.
Power Meter	NI-USB 5680	170100013	05/2019	05/2022
Directional Coupler	Narda 4216-20	01386	Characterized prior to test. No cal required.	Characterized prior to test. No cal required.
Temperature / Humidity Sensor	Testo 184 H1	44220687	05/2020	05/2023



SAR Reference Dipole Calibration Report

Ref : ACR.60.9.21.MVGB.A

SHENZHEN NTEK TESTING TECHNOLOGY CO., LTD.

BUILDING E, FENDA SCIENCE PARK, SANWEI
COMMUNITY, XIXIANG STREET,
BAO'AN DISTRICT, SHENZHEN GUANGDONG, CHINA
MVG COMOSAR REFERENCE DIPOLE

FREQUENCY: 2600 MHZ

SERIAL NO.: SN 03/15 DIP2G600-356

Calibrated at MVG

Z.I. de la pointe du diable

Technopôle Brest Iroise – 295 avenue Alexis de Rochon

29280 PLOUZANE - FRANCE

Calibration date: 03/01/2021



Accreditations #2-6789 and #2-6814
Scope available on www.cofrac.fr

Summary:

This document presents the method and results from an accredited SAR reference dipole calibration performed at MVG, using the COMOSAR test bench. The test results covered by accreditation are traceable to the International System of Units (SI).



SAR REFERENCE DIPOLE CALIBRATION REPORT

Ref: ACR.60.9.21.MVGB.A

	<i>Name</i>	<i>Function</i>	<i>Date</i>	<i>Signature</i>
<i>Prepared by :</i>	Jérôme Luc	Technical Manager	3/1/2021	<i>JLS</i>
<i>Checked by :</i>	Jérôme Luc	Technical Manager	3/1/2021	<i>JLS</i>
<i>Approved by :</i>	Yann Toutain	Laboratory Director	3/1/2021	<i>Yann Toutain</i>

2021.03.01
13:14:51
+01'00'

	<i>Customer Name</i>
<i>Distribution :</i>	SHENZHEN NTEK TESTING TECHNOLOGY CO., LTD.

<i>Issue</i>	<i>Name</i>	<i>Date</i>	<i>Modifications</i>
A	Jérôme Luc	3/1/2021	Initial release



SAR REFERENCE DIPOLE CALIBRATION REPORT

Ref. ACR.60.9.21.MVGB.A

TABLE OF CONTENTS

1	Introduction.....	4
2	Device Under Test	4
3	Product Description	4
3.1	General Information	4
4	Measurement Method	5
4.1	Return Loss Requirements	5
4.2	Mechanical Requirements	5
5	Measurement Uncertainty.....	5
5.1	Return Loss	5
5.2	Dimension Measurement	5
5.3	Validation Measurement	5
6	Calibration Measurement Results.....	6
6.1	Return Loss and Impedance	6
6.2	Mechanical Dimensions	6
7	Validation measurement	7
7.1	Measurement Condition	7
7.2	Head Liquid Measurement	7
7.3	Measurement Result	8
8	List of Equipment	10



SAR REFERENCE DIPOLE CALIBRATION REPORT

Ref: ACR.60.9.21.MVGB.A

1 INTRODUCTION

This document contains a summary of the requirements set forth by the IEEE 1528, FCC KDBs and CEI/IEC 62209 standards for reference dipoles used for SAR measurement system validations and the measurements that were performed to verify that the product complies with the fore mentioned standards.

2 DEVICE UNDER TEST

Device Under Test	
Device Type	COMOSAR 2600 MHz REFERENCE DIPOLE
Manufacturer	MVG
Model	SID2600
Serial Number	SN 03/15 DIP2G600-356
Product Condition (new / used)	Used

3 PRODUCT DESCRIPTION

3.1 GENERAL INFORMATION

MVG’s COMOSAR Validation Dipoles are built in accordance to the IEEE 1528, FCC KDBs and CEI/IEC 62209 standards. The product is designed for use with the COMOSAR test bench only.



Figure 1 – MVG COMOSAR Validation Dipole



SAR REFERENCE DIPOLE CALIBRATION REPORT

Ref: ACR.60.9.21.MVGB.A

4 MEASUREMENT METHOD

The IEEE 1528, FCC KDBs and CEI/IEC 62209 standards provide requirements for reference dipoles used for system validation measurements. The following measurements were performed to verify that the product complies with the fore mentioned standards.

4.1 RETURN LOSS REQUIREMENTS

The dipole used for SAR system validation measurements and checks must have a return loss of -20 dB or better. The return loss measurement shall be performed against a liquid filled flat phantom, with the phantom constructed as outlined in the fore mentioned standards. A direct method is used with a network analyser and its calibration kit, both with a valid ISO17025 calibration.

4.2 MECHANICAL REQUIREMENTS

The IEEE Std. 1528 and CEI/IEC 62209 standards specify the mechanical components and dimensions of the validation dipoles, with the dimension's frequency and phantom shell thickness dependent. The COMOSAR test bench employs a 2 mm phantom shell thickness therefore the dipoles sold for use with the COMOSAR test bench comply with the requirements set forth for a 2 mm phantom shell thickness. A direct method is used with a ISO17025 calibrated caliper.

5 MEASUREMENT UNCERTAINTY

All uncertainties listed below represent an expanded uncertainty expressed at approximately the 95% confidence level using a coverage factor of k=2, traceable to the Internationally Accepted Guides to Measurement Uncertainty.

5.1 RETURN LOSS

The following uncertainties apply to the return loss measurement:

Frequency band	Expanded Uncertainty on Return Loss
400-6000MHz	0.08 LIN

5.2 DIMENSION MEASUREMENT

The following uncertainties apply to the dimension measurements:

Length (mm)	Expanded Uncertainty on Length
0 - 300	0.20 mm
300 - 450	0.44 mm

5.3 VALIDATION MEASUREMENT

The guidelines outlined in the IEEE 1528, FCC KDBs, CENELEC EN50361 and CEI/IEC 62209 standards were followed to generate the measurement uncertainty for validation measurements.

Scan Volume	Expanded Uncertainty



SAR REFERENCE DIPOLE CALIBRATION REPORT

Ref: ACR.60.9.21.MVGB.A

1 g	19 % (SAR)
10 g	19 % (SAR)

6 CALIBRATION MEASUREMENT RESULTS

6.1 RETURN LOSS AND IMPEDANCE

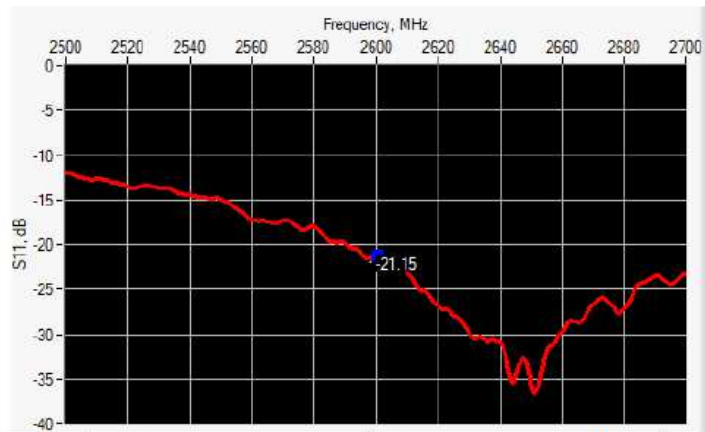

Frequency (MHz)	Return Loss (dB)	Requirement (dB)	Impedance
2600	-21.15	-20	52.7 Ω - 8.3 jΩ

6.2 MECHANICAL DIMENSIONS

Frequency MHz	L mm		h mm		d mm	
	required	measured	required	measured	required	measured
300	420.0 ±1 %.		250.0 ±1 %.		6.35 ±1 %.	
450	290.0 ±1 %.		166.7 ±1 %.		6.35 ±1 %.	
750	176.0 ±1 %.		100.0 ±1 %.		6.35 ±1 %.	
835	161.0 ±1 %.		89.8 ±1 %.		3.6 ±1 %.	
900	149.0 ±1 %.		83.3 ±1 %.		3.6 ±1 %.	
1450	89.1 ±1 %.		51.7 ±1 %.		3.6 ±1 %.	
1500	80.5 ±1 %.		50.0 ±1 %.		3.6 ±1 %.	
1640	79.0 ±1 %.		45.7 ±1 %.		3.6 ±1 %.	
1750	75.2 ±1 %.		42.9 ±1 %.		3.6 ±1 %.	
1800	72.0 ±1 %.		41.7 ±1 %.		3.6 ±1 %.	
1900	68.0 ±1 %.		39.5 ±1 %.		3.6 ±1 %.	
1950	66.3 ±1 %.		38.5 ±1 %.		3.6 ±1 %.	
2000	64.5 ±1 %.		37.5 ±1 %.		3.6 ±1 %.	
2100	61.0 ±1 %.		35.7 ±1 %.		3.6 ±1 %.	
2300	55.5 ±1 %.		32.6 ±1 %.		3.6 ±1 %.	
2450	51.5 ±1 %.		30.4 ±1 %.		3.6 ±1 %.	



SAR REFERENCE DIPOLE CALIBRATION REPORT

Ref: ACR.60.9.21.MVGB.A

2600	48.5 ±1 %.	-	28.8 ±1 %.	-	3.6 ±1 %.	-
3000	41.5 ±1 %.		25.0 ±1 %.		3.6 ±1 %.	
3500	37.0 ±1 %.		26.4 ±1 %.		3.6 ±1 %.	
3700	34.7 ±1 %.		26.4 ±1 %.		3.6 ±1 %.	

7 VALIDATION MEASUREMENT

The IEEE Std. 1528, FCC KDBs and CEI/IEC 62209 standards state that the system validation measurements must be performed using a reference dipole meeting the fore mentioned return loss and mechanical dimension requirements. The validation measurement must be performed against a liquid filled flat phantom, with the phantom constructed as outlined in the fore mentioned standards. Per the standards, the dipole shall be positioned below the bottom of the phantom, with the dipole length centered and parallel to the longest dimension of the flat phantom, with the top surface of the dipole at the described distance from the bottom surface of the phantom.

7.1 MEASUREMENT CONDITION

Software	OPENSAR V5
Phantom	SN 13/09 SAM68
Probe	SN 41/18 EPGO333
Liquid	Head Liquid Values: ϵ_r' : 41.5 σ : 2.03
Distance between dipole center and liquid	10.0 mm
Area scan resolution	dx=8mm/dy=8mm
Zoon Scan Resolution	dx=5mm/dy=5mm/dz=5mm
Frequency	2600/2600 MHz
Input power	20 dBm
Liquid Temperature	20 +/- 1 °C
Lab Temperature	20 +/- 1 °C
Lab Humidity	30-70 %

7.2 HEAD LIQUID MEASUREMENT

Frequency MHz	Relative permittivity (ϵ_r')		Conductivity (σ) S/m	
	required	measured	required	measured
300	45.3 ±10 %		0.87 ±10 %	
450	43.5 ±10 %		0.87 ±10 %	
750	41.9 ±10 %		0.89 ±10 %	
835	41.5 ±10 %		0.90 ±10 %	
900	41.5 ±10 %		0.97 ±10 %	
1450	40.5 ±10 %		1.20 ±10 %	
1500	40.4 ±10 %		1.23 ±10 %	
1640	40.2 ±10 %		1.31 ±10 %	
1750	40.1 ±10 %		1.37 ±10 %	
1800	40.0 ±10 %		1.40 ±10 %	
1900	40.0 ±10 %		1.40 ±10 %	
1950	40.0 ±10 %		1.40 ±10 %	
2000	40.0 ±10 %		1.40 ±10 %	



SAR REFERENCE DIPOLE CALIBRATION REPORT

Ref: ACR.60.9.21.MVGB.A

2100	39.8 ±10 %		1.49 ±10 %	
2300	39.5 ±10 %		1.67 ±10 %	
2450	39.2 ±10 %		1.80 ±10 %	
2600	39.0 ±10 %	41.5	1.96 ±10 %	2.03
3000	38.5 ±10 %		2.40 ±10 %	
3500	37.9 ±10 %		2.91 ±10 %	

7.3 MEASUREMENT RESULT

The IEEE Std. 1528 and CEI/IEC 62209 standards state that the system validation measurements should produce the SAR values shown below (for phantom thickness of 2 mm), within the uncertainty for the system validation. All SAR values are normalized to 1 W forward power. In bracket, the measured SAR is given with the used input power.

Frequency MHz	1 g SAR (W/kg/W)		10 g SAR (W/kg/W)	
	required	measured	required	measured
300	2.85		1.94	
450	4.58		3.06	
750	8.49		5.55	
835	9.56		6.22	
900	10.9		6.99	
1450	29		16	
1500	30.5		16.8	
1640	34.2		18.4	
1750	36.4		19.3	
1800	38.4		20.1	
1900	39.7		20.5	
1950	40.5		20.9	
2000	41.1		21.1	
2100	43.6		21.9	
2300	48.7		23.3	
2450	52.4		24	
2600	55.3	55.83 (5.58)	24.6	24.19 (2.42)
3000	63.8		25.7	
3500	67.1		25	



SAR REFERENCE DIPOLE CALIBRATION REPORT

Ref: ACR.60.9.21.MVGB.A

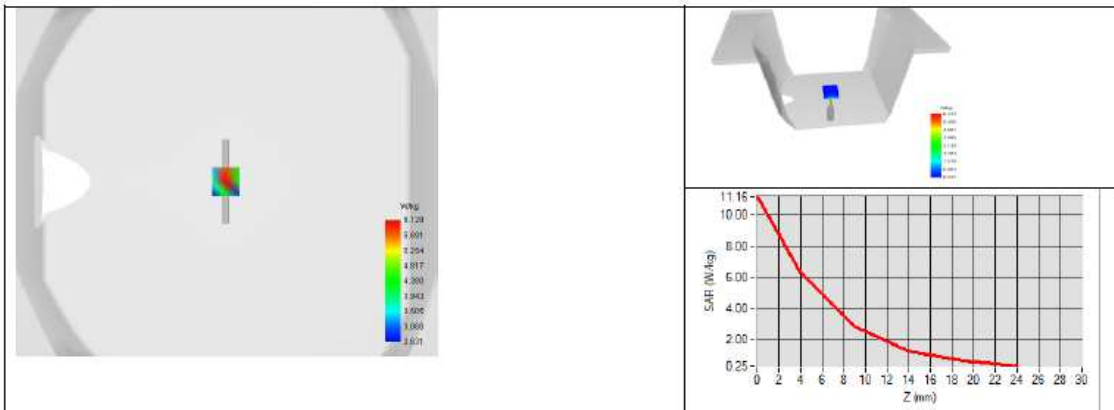



SAR REFERENCE DIPOLE CALIBRATION REPORT

Ref: ACR.60.9.21.MVGB.A

8 LIST OF EQUIPMENT

Equipment Summary Sheet				
Equipment Description	Manufacturer / Model	Identification No.	Current Calibration Date	Next Calibration Date
SAM Phantom	MVG	SN-13/09-SAM68	Validated. No cal required.	Validated. No cal required.
COMOSAR Test Bench	Version 3	NA	Validated. No cal required.	Validated. No cal required.
Network Analyzer	Rohde & Schwarz ZVM	100203	05/2019	05/2022
Network Analyzer – Calibration kit	Rohde & Schwarz ZV-Z235	101223	05/2019	05/2022
Calipers	Mitutoyo	SN 0009732	10/2019	10/2022
Reference Probe	MVG	EPGO333 SN 41/18	05/2020	05/2021
Multimeter	Keithley 2000	1160271	02/2020	02/2023
Signal Generator	Rohde & Schwarz SMB	106589	04/2019	04/2022
Amplifier	Aethercomm	SN 046	Characterized prior to test. No cal required.	Characterized prior to test. No cal required.
Power Meter	NI-USB 5680	170100013	05/2019	05/2022
Directional Coupler	Narda 4216-20	01386	Characterized prior to test. No cal required.	Characterized prior to test. No cal required.
Temperature / Humidity Sensor	Testo 184 H1	44220687	05/2020	05/2023



SAR Reference Waveguide Calibration Report

Ref : ACR.60.10.21.MVGB.A

SHENZHEN NTEK TESTING TECHNOLOGY CO., LTD.

BUILDING E, FENDA SCIENCE PARK, SANWEI
COMMUNITY, XIXIANG STREET,
BAO'AN DISTRICT, SHENZHEN GUANGDONG, CHINA
SATIMO COMOSAR REFERENCE WAVEGUIDE

FREQUENCY: 5000-6000 MHZ

SERIAL NO.: SN 13/14 WGA33

Calibrated at MVG

Z.I. de la pointe du diable

Technopôle Brest Iroise – 295 avenue Alexis de Rochon
29280 PLOUZANE - FRANCE

Calibration date: 03/01/2021



Accreditations #2-6789 and #2-6814
Scope available on www.cofrac.fr

Summary:

This document presents the method and results from an accredited SAR reference waveguide calibration performed at MVG, using the COMOSAR test bench. The test results covered by accreditation are traceable to the International System of Units (SI).



SAR REFERENCE WAVEGUIDE CALIBRATION REPORT

Ref: ACR.60.10.21.MVGB.A

	Name	Function	Date	Signature
Prepared by :	Jérôme Luc	Technical Manager	3/1/2021	<i>JLS</i>
Checked by :	Jérôme Luc	Technical Manager	3/1/2021	<i>JLS</i>
Approved by :	Yann Toutain	Laboratory Director	3/1/2021	<i>Yann Toutain</i>

2021.03.0
1 13:15:44
+01'00'

	Customer Name
Distribution :	SHENZHEN NTEK TESTING TECHNOLOGY CO., LTD.

Issue	Name	Date	Modifications
A	Jérôme Luc	3/1/2021	Initial release



SAR REFERENCE WAVEGUIDE CALIBRATION REPORT

Ref: ACR.60.10.21.MVGB.A

TABLE OF CONTENTS

1	Introduction.....	4
2	Device Under Test	4
3	Product Description	4
3.1	General Information	4
4	Measurement Method	4
4.1	Return Loss Requirements	4
4.2	Mechanical Requirements	4
5	Measurement Uncertainty.....	5
5.1	Return Loss	5
5.2	Dimension Measurement	5
5.3	Validation Measurement	5
6	Calibration Measurement Results.....	5
6.1	Return Loss	5
6.2	Mechanical Dimensions	6
7	Validation measurement	6
7.1	Head Liquid Measurement	8
7.2	Measurement Result	8
8	List of Equipment	11



SAR REFERENCE WAVEGUIDE CALIBRATION REPORT

Ref: ACR.60.10.21.MVGB.A

1 INTRODUCTION

This document contains a summary of the requirements set forth by the IEEE 1528 and CEI/IEC 62209 standards for reference waveguides used for SAR measurement system validations and the measurements that were performed to verify that the product complies with the fore mentioned standards.

2 DEVICE UNDER TEST

Device Under Test	
Device Type	COMOSAR 5000-6000 MHz REFERENCE WAVEGUIDE
Manufacturer	MVG
Model	SWG5500
Serial Number	SN 13/14 WGA33
Product Condition (new / used)	Used

3 PRODUCT DESCRIPTION

3.1 GENERAL INFORMATION

MVG's COMOSAR Validation Waveguides are built in accordance to the IEEE 1528 and CEI/IEC 62209 standards.

4 MEASUREMENT METHOD

The IEEE 1528 and CEI/IEC 62209 standards provide requirements for reference waveguides used for system validation measurements. The following measurements were performed to verify that the product complies with the fore mentioned standards.

4.1 RETURN LOSS REQUIREMENTS

The waveguide used for SAR system validation measurements and checks must have a return loss of -8 dB or better. The return loss measurement shall be performed with matching layer placed in the open end of the waveguide, with the waveguide and matching layer in direct contact with the phantom shell as outlined in the fore mentioned standards. A direct method is used with a network analyser and its calibration kit, both with a valid ISO17025 calibration.

4.2 MECHANICAL REQUIREMENTS

The IEEE 1528 and CEI/IEC 62209 standards specify the mechanical dimensions of the validation waveguide, the specified dimensions are as shown in Section 6.2. Figure 1 shows how the dimensions relate to the physical construction of the waveguide. A direct method is used with a ISO17025 calibrated caliper.



SAR REFERENCE WAVEGUIDE CALIBRATION REPORT

Ref: ACR.60.10.21.MVGB.A

5 MEASUREMENT UNCERTAINTY

All uncertainties listed below represent an expanded uncertainty expressed at approximately the 95% confidence level using a coverage factor of k=2, traceable to the Internationally Accepted Guides to Measurement Uncertainty.

5.1 RETURN LOSS

The following uncertainties apply to the return loss measurement:

Frequency band	Expanded Uncertainty on Return Loss
400-6000MHz	0.08 LIN

5.2 DIMENSION MEASUREMENT

The following uncertainties apply to the dimension measurements:

Length (mm)	Expanded Uncertainty on Length
0 - 300	0.20 mm

5.3 VALIDATION MEASUREMENT

The guidelines outlined in the IEEE 1528 and CEI/IEC 62209 standards were followed to generate the measurement uncertainty for validation measurements.

Scan Volume	Expanded Uncertainty
1 g	19 % (SAR)
10 g	19 % (SAR)

6 CALIBRATION MEASUREMENT RESULTS

6.1 RETURN LOSS

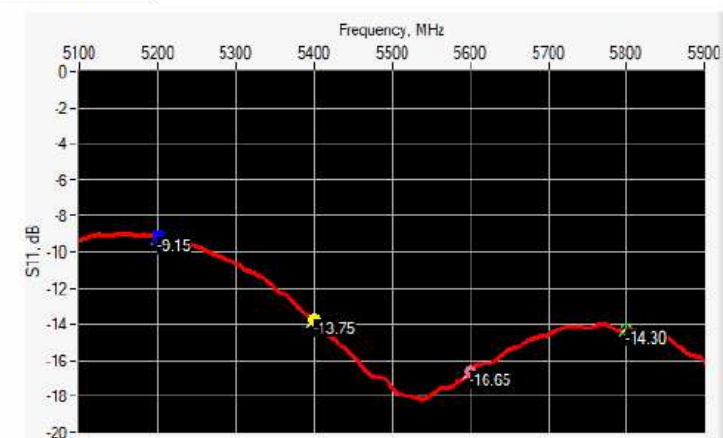



SAR REFERENCE WAVEGUIDE CALIBRATION REPORT

Ref: ACR.60.10.21.MVGB.A

Frequency (MHz)	Return Loss (dB)	Requirement (dB)	Impedance
5200	-9.15	-8	$21.17 \Omega + 13.26 j\Omega$
5400	-13.75	-8	$68.57 \Omega + 6.68 j\Omega$
5600	-16.65	-8	$35.76 \Omega - 2.15 j\Omega$
5800	-14.30	-8	$54.74 \Omega + 18.27 j\Omega$

6.2 MECHANICAL DIMENSIONS

Frequency (MHz)	L (mm)		W (mm)		L _f (mm)		W _f (mm)	
	Required	Measured	Required	Measured	Required	Measured	Required	Measured
5800	40.39 ± 0.13	-	20.19 ± 0.13	-	81.03 ± 0.13	-	61.98 ± 0.13	-

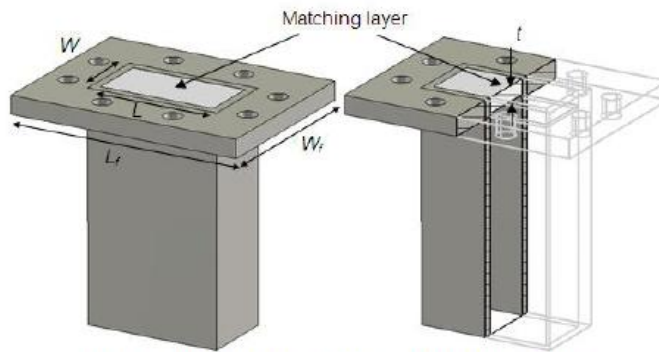

Figure 1: Validation Waveguide Dimensions

7 VALIDATION MEASUREMENT

The IEEE Std. 1528 and CEI/IEC 62209 standards state that the system validation measurements must be performed using a reference waveguide meeting the fore mentioned return loss and mechanical dimension requirements. The validation measurement must be performed with the matching layer placed in the open end of the waveguide, with the waveguide and matching layer in direct contact with the phantom shell.



SAR REFERENCE WAVEGUIDE CALIBRATION REPORT

Ref: ACR.60.10.21.MVGB.A

Measurement Condition

Software	OPENSAR V5
Phantom	SN 13/09 SAM68
Probe	SN 41/18 EPG0333
Liquid	Head Liquid Values 5200 MHz: eps' :34.06 sigma : 4.70 Head Liquid Values 5400 MHz: eps' :33.39 sigma : 4.91 Head Liquid Values 5600 MHz: eps' :32.77 sigma : 5.13 Head Liquid Values 5800 MHz: eps' :32.40 sigma : 5.34
Distance between dipole waveguide and liquid	0 mm
Area scan resolution	dx=8mm/dy=8mm
Zoon Scan Resolution	dx=4mm/dy=4m/dz=2mm
Frequency	5200 MHz 5400 MHz 5600 MHz 5800 MHz
Input power	20 dBm
Liquid Temperature	20 +/- 1 °C
Lab Temperature	20 +/- 1 °C
Lab Humidity	30-70 %



SAR REFERENCE WAVEGUIDE CALIBRATION REPORT

Ref: ACR.60.10.21.MVGB.A

7.1 HEAD LIQUID MEASUREMENT

Frequency MHz	Relative permittivity (ϵ_r')		Conductivity (σ) S/m	
	required	measured	required	measured
5000	36.2 ±10 %		4.45 ±10 %	
5100	36.1 ±10 %		4.56 ±10 %	
5200	36.0 ±10 %	34.06	4.66 ±10 %	4.70
5300	35.9 ±10 %		4.76 ±10 %	
5400	35.8 ±10 %	33.39	4.86 ±10 %	4.91
5500	35.6 ±10 %		4.97 ±10 %	
5600	35.5 ±10 %	32.77	5.07 ±10 %	5.13
5700	35.4 ±10 %		5.17 ±10 %	
5800	35.3 ±10 %	32.40	5.27 ±10 %	5.34
5900	35.2 ±10 %		5.38 ±10 %	
6000	35.1 ±10 %		5.48 ±10 %	

7.2 MEASUREMENT RESULT

At those frequencies, the target SAR value can not be generic. Hereunder is the target SAR value defined by Satimo, within the uncertainty for the system validation. All SAR values are normalized to 1 W net power. In bracket, the measured SAR is given with the used input power.

Frequency (MHz)	1 g SAR (W/kg)		10 g SAR (W/kg)	
	required	measured	required	measured
5200	159.00	162.34 (16.23)	56.90	55.42 (5.54)
5400	166.40	168.48 (16.85)	58.43	57.03 (5.70)
5600	173.80	174.92 (17.49)	59.97	58.63 (5.86)
5800	181.20	178.89 (17.89)	61.50	59.32 (5.93)



SAR REFERENCE WAVEGUIDE CALIBRATION REPORT

Ref: ACR.60.10.21.MVGB.A

SAR MEASUREMENT PLOTS @ 5200 MHz

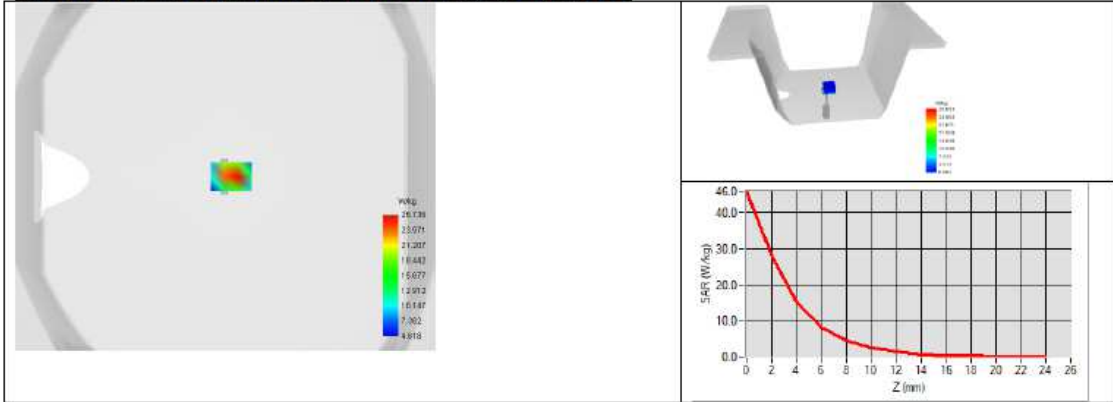

SAR MEASUREMENT PLOTS @ 5400 MHz

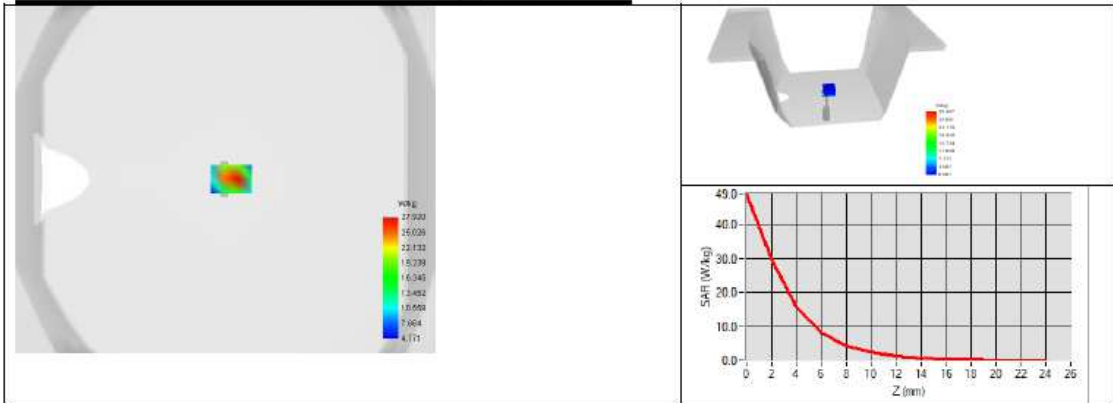

SAR MEASUREMENT PLOTS @ 5600 MHz

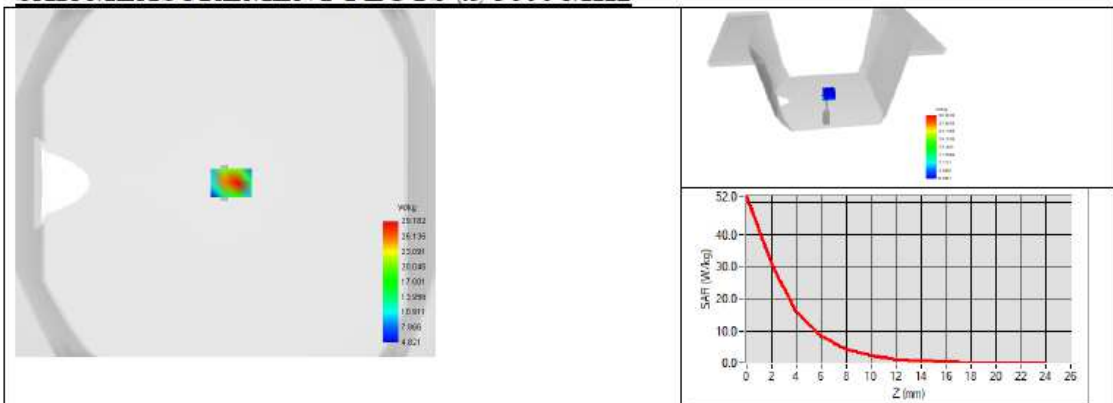



SAR REFERENCE WAVEGUIDE CALIBRATION REPORT

Ref. ACR.60.10.21.MVGB.A

SAR MEASUREMENT PLOTS @ 5800 MHz

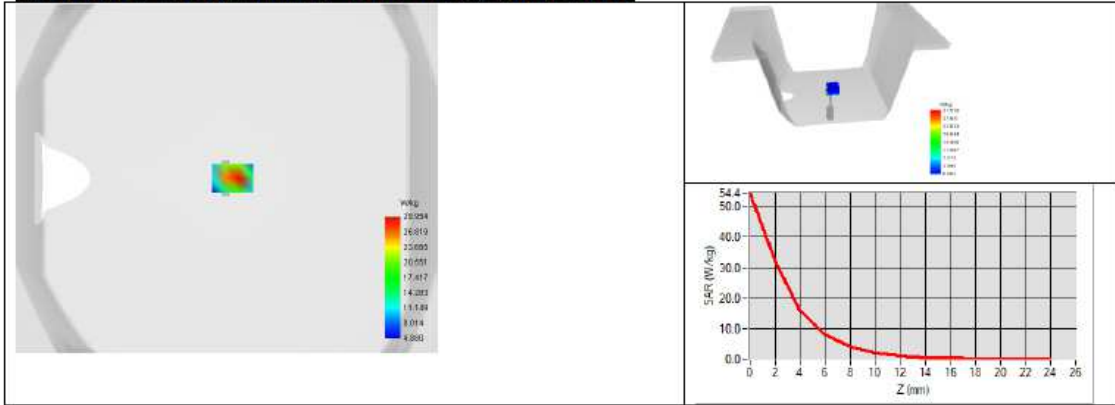



SAR REFERENCE WAVEGUIDE CALIBRATION REPORT

Ref. ACR.60.10.21.MVGB.A

8 LIST OF EQUIPMENT

Equipment Summary Sheet				
Equipment Description	Manufacturer / Model	Identification No.	Current Calibration Date	Next Calibration Date
Flat Phantom	MVG	SN-13/09-SAM68	Validated. No cal required.	Validated. No cal required.
COMOSAR Test Bench	Version 3	NA	Validated. No cal required.	Validated. No cal required.
Network Analyzer	Rohde & Schwarz ZVM	100203	05/2019	05/2022
Network Analyzer – Calibration kit	Rohde & Schwarz ZV-Z235	101223	05/2019	05/2022
Calipers	Mitutoyo	SN 0009732	10/2019	10/2022
Reference Probe	MVG	EPGO333 SN 41/18	05/2020	05/2021
Multimeter	Keithley 2000	1160271	02/2020	02/2023
Signal Generator	Rohde & Schwarz SMB	106589	04/2019	04/2022
Amplifier	Aethercomm	SN 046	Characterized prior to test. No cal required.	Characterized prior to test. No cal required.
Power Meter	NI-USB 5680	170100013	05/2019	05/2022
Directional Coupler	Narda 4216-20	01386	Characterized prior to test. No cal required.	Characterized prior to test. No cal required.
Temperature / Humidity Sensor	Testo 184 H1	44220687	05/2020	05/2023