



RADIO TEST REPORT-BLE

ETSI EN 300 328 V2.2.2 (2019-07)

Product : Mobile Phone

Trade Mark : Blackview

Model Name : BV6600

Family Model : N/A

Report No. : STR201229002002E

Prepared for

DOKE COMMUNICATION (HK) LIMITED
RM 1902 EASEY COMM BLDG 253-261 HENNESSY ROAD WANCHAI
HK CHINA

Prepared by

Shenzhen NTEK Testing Technology Co., Ltd.
1/F, Building E, Fenda Science Park, Sanwei Community, Xixiang Street
Bao'an District, Shenzhen 518126 P.R. China
Tel. 400-800-6106, 0755-3699 5508
Website: <http://www.ntek.org.cn>

TEST RESULT CERTIFICATION

Applicant's name : DOKE COMMUNICATION (HK) LIMITED
Address : RM 1902 EASEY COMM BLDG 253-261 HENNESSY ROAD
WANCHAI HK CHINA
Manufacturer's Name : Shenzhen DOKE Electronic Co.,Ltd
Address : Room 801, Building 3, 7th Industrial Zone, Yulv Community, Yutang
Street, Guangming District, Shenzhen,China

Product description

Product name : Mobile Phone
Trademark : Blackview
Model Name : BV6600
Family Model : N/A

Standards : ETSI EN 300 328 V2.2.2 (2019-07)

This device described above has been tested by Shenzhen NTEK, and the test results show that the equipment under test (EUT) is in compliance with the 2014/53/EU RED Directive Art.3.2 requirements. And it is applicable only to the tested sample identified in the report.

This report shall not be reproduced except in full, without the written approval of Shenzhen NTEK, this document may be altered or revised by Shenzhen NTEK, personnel only, and shall be noted in the revision of the document.

Date of Test..... :

Date (s) of performance of tests : 29 Dec. 2020 ~ 19 Jan. 2021

Date of Issue : 19 Jan. 2021

Test Result : **Pass**

Testing Engineer :

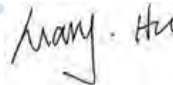

(Mary Hu)

Technical Manager :

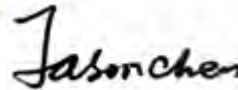

(Jason Chen)

Authorized Signatory :



(Alex Li)

Table of Contents

Page

1 . GENERAL INFORMATION	7
1.1 GENERAL DESCRIPTION OF EUT	7
1.2 INFORMATION ABOUT THE EUT	8
1.3 TEST CONDITIONS AND CHANNEL	13
1.4 DESCRIPTION OF TEST CONDITIONS	14
1.5 DESCRIPTION OF SUPPORT UNITS	15
1.6 EQUIPMENTS LIST FOR ALL TEST ITEMS	16
2 . SUMMARY OF TEST RESULTS	17
2.1 TEST FACILITY	18
2.2 MEASUREMENT UNCERTAINTY	18
3 . TEST PROCEDURES AND RESULTLS	19
3.1 EQUIVALENT ISOTROPIC RADIATED POWER	19
3.1.1 LIMITS OF EQUIVALENT ISOTROPIC RADIATED POWER	19
3.1.2 TEST PROCEDURE	19
3.1.3 TEST SETUP	19
3.1.4 TEST RESULTS	20
3.2 . PEAK POWER DENSITY	21
3.2.1 LIMITS OF POWER SPECTRAL DENSITY	21
3.2.2 TEST PROCEDURE	21
3.2.3 TEST SETUP	21
3.2.4 TEST RESULTS	22
3.3 . OCCUPIED CHANNEL BANDWIDTH	23
3.3.1 LIMITS OF OCCUPIED CHANNEL BANDWIDTH	23
3.3.2 TEST PROCEDURE	23
3.3.3 DEVIATION FROM TEST STANDARD	23
3.3.4 TEST SETUP	23
3.3.5 TEST RESULTS	24
3.4 . TRANSMITTER UNWANTED EMISSIONS IN THE OUT-OF-BAND DOMAIN	25
3.4.1 LIMITS OF TRANSMITTER UNWANTED EMISSIONS IN THE OUT-OF-BAND DOMAIN	25
3.4.2 TEST PROCEDURE	25
3.4.3 DEVIATION FROM TEST STANDARD	26
3.4.4 TEST SETUP	26
3.4.5 TEST RESULTS	27
3.5 . ADAPTIVE (CHANNEL ACCESS MECHANISM)	28
3.5.1 APPLICABILITY OF ADAPTIVE REQUIREMENTS AND LILIT FOR WIDE BAND MODULATION TECHNIQUES	28
3.5.2 TEST PROCEDURE	29

Table of Contents

Page

3.5.3 TEST SETUP CONFIGURATION	29
3.5.4 LIST OF MEASUREMENTS	30
3.5.5 TEST RESULTS	31
3.6 . TRANSMITTER UNWANTED EMISSIONS IN THE SPURIOUS DOMAIN	32
3.6.1 LIMITS OF TRANSMITTER UNWANTED EMISSIONS IN THE SPURIOUS DOMAIN	32
3.6.2 TEST PROCEDURE	32
3.6.3 DEVIATION FROM TEST STANDARD	32
3.6.4 TEST SETUP	33
3.6.5 TEST RESULTS(Radiated measurement)	34
3.6.6 TEST RESULTS (Conducted measurement)	35
3.7 . RECEIVER SPURIOUS RADIATION	36
3.7.1 LIMITS OF RECEIVER SPURIOUS RADIATION	36
3.7.2 TEST PROCEDURE	36
3.7.3 DEVIATION FROM TEST STANDARD	36
3.7.4 TEST SETUP	37
3.7.5 TEST RESULTS(Radiated measurement)	38
3.7.6 TEST RESULTS (Conducted measurement)	39
3.8 . RECEIVER BLOCKING	40
3.8.1 PERFORMANCE CRITERIA	40
3.8.2 LIMITS OF RECEIVER BLOCKING	40
3.8.3 TEST PROCEDURE	42
3.8.4 DEVIATION FROM TEST STANDARD	42
3.8.5 TEST SETUP	42
3.8.6 TEST RESULTS	43
4 . TEST RESULTS	44
1M:	44
4.1.1 RF OUTPUT POWER	44
4.1.2 POWER SPECTRAL DENSITY	46
4.1.3 OCCUPIED CHANNEL BANDWIDTH	48
4.1.4 TRANSMITTER UNWANTED EMISSIONS IN THE OUT-OF-BAND DOMAIN	50
4.1.5 TRANSMITTER UNWANTED EMISSIONS IN THE SPURIOUS DOMAIN	51
4.1.6 RECEIVER SPURIOUS EMISSIONS	53
2M:	55
4.2.1 RF OUTPUT POWER	55
4.2.2 POWER SPECTRAL DENSITY	57
4.2.3 OCCUPIED CHANNEL BANDWIDTH	59
4.2.4 TRANSMITTER UNWANTED EMISSIONS IN THE OUT-OF-BAND DOMAIN	61
4.2.5 TRANSMITTER UNWANTED EMISSIONS IN THE SPURIOUS DOMAIN	62
4.2.6 RECEIVER SPURIOUS EMISSIONS	64
5 . EUT TEST PHOTO	66

Table of Contents

Page

SPURIOUS EMISSIONS MEASUREMENT PHOTOS

66

1. GENERAL INFORMATION

1.1 GENERAL DESCRIPTION OF EUT

Equipment	Mobile Phone
Trade Mark	Blackview
Model Name.	BV6600
Family Model	N/A
Model Difference	N/A
Product Description	The EUT is Mobile Phone
	Operation Frequency: 2402~2480 MHz
	Modulation Type: GFSK
	Adaptive/non-adaptive Adaptive equipment
	Receiver categories 2
	Number Of Channel Please see Note 2.
	Antenna Designation: FPC Antenna
	Antenna Gain(Peak) 0.8 dBi
Channel List	Refer to below
Adapter	Input: 100-240V~50/60Hz 0.6A Output: 5.0V---3.0A
Battery type&specification	DC 3.85V, 8580mAh, 33.03Wh
Rating	DC 3.85V from battery or DC 5V from Adapter
I/O Ports	Refer to users manual
Hardware Version	ZN128 MBB3 BOM10
Software Version	BV6600_EEA_ZN128F_V1.0

Note:

1. For a more detailed features description, please refer to the manufacturer's specifications or the User's Manual.

2.

Channel	Frequency (MHz)
00	2402
01	2404
.....
.....
38	2478
39	2480

1.2 INFORMATION ABOUT THE EUT

a) The type of modulation used by the equipment:

- FHSS
- other forms of modulation

b) In case of FHSS modulation:

- In case of non-Adaptive Frequency Hopping equipment:

The number of Hopping Frequencies:

- In case of Adaptive Frequency Hopping Equipment:

The maximum number of Hopping Frequencies:

The minimum number of Hopping Frequencies:

- The (average) Dwell Time:

c) Adaptive / non-adaptive equipment:

- non-adaptive Equipment
- adaptive Equipment without the possibility to switch to a non-adaptive mode
- adaptive Equipment which can also operate in a non-adaptive mode

d) In case of adaptive equipment:

The maximum Channel Occupancy Time implemented by the equipment: ./. ms

- The equipment has implemented an LBT based DAA mechanism

- In case of equipment using modulation different from FHSS:

- The equipment is Frame Based equipment
- The equipment is Load Based equipment
- The equipment can switch dynamically between Frame Based and Load Based equipment

The CCA time implemented by the equipment: / μs

- The equipment has implemented a non-LBT based DAA mechanism
- The equipment can operate in more than one adaptive mode

e) In case of non-adaptive Equipment:

The maximum RF Output Power (e.i.r.p.):

The maximum (corresponding) Duty Cycle:

Equipment with dynamic behaviour, that behaviour is described here. (e.g. the different combinations of duty cycle and corresponding power levels to be declared):

f) The worst case operational mode for each of the following tests:

- RF Output Power
GFSK
- Power Spectral Density
GFSK
- Duty cycle, Tx-Sequence, Tx-gap
N/A
- Accumulated Transmit time, Frequency Occupation & Hopping Sequence (only for FHSS equipment)
N/A
- Hopping Frequency Separation (only for FHSS equipment)
N/A
- Medium Utilization
N/A
- Adaptivity
N/A
- Receiver Blocking
GFSK
- Nominal Channel Bandwidth
GFSK
- Transmitter unwanted emissions in the OOB domain
GFSK
- Transmitter unwanted emissions in the spurious domain
GFSK
- Receiver spurious emissions
GFSK

g) The different transmit operating modes (tick all that apply):

- Operating mode 1: Single Antenna Equipment
 - Equipment with only one antenna
 - Equipment with two diversity antennas but only one antenna active at any moment in time
 - Smart Antenna Systems with two or more antennas, but operating in a (legacy) mode where only one antenna is used (e.g. IEEE 802.11™ [i.3] legacy mode in smart antenna systems)
- Operating mode 2: Smart Antenna Systems - Multiple Antennas without beam forming
 - Single spatial stream / Standard throughput / (e.g. IEEE 802.11™ [i.3] legacy mode)

- High Throughput (> 1 spatial stream) using Nominal Channel Bandwidth 1
- High Throughput (> 1 spatial stream) using Nominal Channel Bandwidth 2

NOTE 1: Add more lines if more channel bandwidths are supported.

- Operating mode 3: Smart Antenna Systems - Multiple Antennas with beam forming
 - Single spatial stream / Standard throughput (e.g. IEEE 802.11™ [i.3] legacy mode)
 - High Throughput (> 1 spatial stream) using Nominal Channel Bandwidth 1
 - High Throughput (> 1 spatial stream) using Nominal Channel Bandwidth 2

NOTE 2: Add more lines if more channel bandwidths are supported.

h) In case of Smart Antenna Systems:

- The number of Receive chains:
- The number of Transmit chains:
 - symmetrical power distribution
 - asymmetrical power distribution

In case of beam forming, the maximum (additional) beam forming gain: dB

NOTE: The additional beam forming gain does not include the basic gain of a single antenna.

i) Operating Frequency Range(s) of the equipment:

- Operating Frequency Range 1: 2402 MHz to 2480 MHz(1M)
 - Operating Frequency Range 2: 2402 MHz to 2480 MHz(2M)
- NOTE: Add more lines if more Frequency Ranges are supported.

j) Nominal Channel Bandwidth(s):

- Nominal Channel Bandwidth 1: 1.007 MHz(1M)
 - Nominal Channel Bandwidth 2: 2.034 MHz(2M)
- NOTE: Add more lines if more channel bandwidths are supported.

k) Type of Equipment (stand-alone, combined, plug-in radio device, etc.):

- Stand-alone
- Combined Equipment (Equipment where the radio part is fully integrated within another type of equipment)
- Plug-in radio device (Equipment intended for a variety of host systems)
- Other

l) The normal and the extreme operating conditions that apply to the equipment:

Normal operating conditions (if applicable):

Operating temperature: 15°C~35°C
 Other (please specify if applicable):

Extreme operating conditions:

Operating temperature range: Minimum: -10°C Maximum 40°C
 Other (please specify if applicable): Minimum: Maximum
 Details provided are for the:

- stand-alone equipment
- combined (or host) equipment
- test jig

m) The intended combination(s) of the radio equipment power settings and one or more antenna assemblies and their corresponding e.i.r.p. levels:

- Antenna Type: FPC Antenna

Integral Antenna (information to be provided in case of conducted measurements)

Antenna Gain: 0.8 dBi

If applicable, additional beamforming gain (excluding basic antenna gain): dB

Temporary RF connector provided

No temporary RF connector provided

Dedicated Antennas (equipment with antenna connector)

Single power level with corresponding antenna(s)

Multiple power settings and corresponding antenna(s)

Number of different Power Levels:

Power Level 1: dBm

Power Level 2: dBm

Power Level 3: dBm

NOTE 1: Add more lines in case the equipment has more power levels.

NOTE 2: These power levels are conducted power levels (at antenna connector).

- For each of the Power Levels, provide the intended antenna assemblies, their corresponding gains (G) and the resulting e.i.r.p. levels also taking into account the beamforming gain (Y) if applicable

Power Level 1: dBm

Number of antenna assemblies provided for this power level:

Assembly #	Gain (dBi)	e.i.r.p. (dBm)	Part number or model name
1(1M)	0.8	3.97	
2(2M)	0.8	3.36	
3			

NOTE 3: Add more rows in case more antenna assemblies are supported for this power level.

Power Level 2: dBm

Number of antenna assemblies provided for this power level:

Assembly #	Gain (dBi)	e.i.r.p. (dBm)	Part number or model name
1			
2			
3			

NOTE 4: Add more rows in case more antenna assemblies are supported for this power level.

Power Level 3: dBm

Number of antenna assemblies provided for this power level:

Assembly #	Gain (dBi)	e.i.r.p. (dBm)	Part number or model name
1			
2			
3			

NOTE 5: Add more rows in case more antenna assemblies are supported for this power level.

n) The nominal voltages of the stand-alone radio equipment or the nominal voltages of the combined (host) equipment or test jig in case of plug-in devices:

Details provided are for the:

- stand-alone equipment
- combined (or host) equipment
- test jig

Supply Voltage AC mains State AC voltage V
 DC State DC voltage: DC 3.85V

In case of DC, indicate the type of power source

- Internal Power Supply
- External Power Supply or AC/DC adapter: DC 5V
- Battery: DC 3.85V
- Other:

o) Describe the test modes available which can facilitate testing:

See section 1.3

p) The equipment type (e.g. Bluetooth®, IEEE 802.11™ [i.3], IEEE 802.15.4™ [i.4], proprietary, etc.):

Bluetooth®

q) If applicable, the statistical analysis referred to in clause 5.4.1 q)

(to be provided as separate attachment)

r) If applicable, the statistical analysis referred to in clause 5.4.1 r)

(to be provided as separate attachment)

s) Geo-location capability supported by the equipment:

- Yes
- The geographical location determined by the equipment as defined in clause 4.3.1.13.2 or clause 4.3.2.12.2 is not accessible to the user
- No

t) Describe the minimum performance criteria that apply to the equipment (see clause 4.3.1.12.3 or clause 4.3.2.11.3):

GFSK CH39/PER=0.96%

1.3 TEST CONDITIONS AND CHANNEL

	Normal Test Conditions	Extreme Test Conditions
Temperature	15°C - 35°C	40°C ~ -10°C Note: (1)
Relative Humidity	20% - 75%	N/A
Supply Voltage	DC 3.85V	/

Test Channel	EUT Channel	Test Frequency (MHz)
Lowest	CH00	2402
Middle	CH19	2440
Highest	CH39	2480

Note:

- (1) The HT 40°C and LT -10°C was declared by manufacturer, The EUT couldn't be operate normally with higher or lower temperature.
- (2) The measurements are performed at the highest, middle, lowest available channels.

1.4 DESCRIPTION OF TEST CONDITIONS

E-1
EUT

1.5 DESCRIPTION OF SUPPORT UNITS

The EUT has been tested as an independent unit together with other necessary accessories or support units. The following support units or accessories were used to form a representative test configuration during the tests.

Item	Equipment	Brand	Model/Type No.	Series No.	Note
E-1	Mobile Phone	Blackview	BV6600	N/A	EUT

Item	Type	Shielded Type	Ferrite Core	Length	Note

Note:

- (1) The support equipment was authorized by Declaration of Confirmation.
- (2) For detachable type I/O cable should be specified the length in cm in 『Length』 column.

1.6 EQUIPMENTS LIST FOR ALL TEST ITEMS

EQUIPMENT TYPE	Manufacturer	Type No.	Serial No.	Last calibration	Calibrated until	Calibration period
EMI Test Receiver	R&S	ESPI7	101318	2020.05.11	2021.05.10	1 year
Bilog Antenna	TESEQ	CBL6111D	31216	2020.04.11	2021.04.10	1 year
Turn Table	EM	SC100_1	60531	N/A	N/A	N/A
Antnna Mast	EM	SC100	N/A	N/A	N/A	N/A
Horn Antenna	EM	EM-AH-10180	2011071402	2020.04.11	2021.04.10	1 year
Horn Ant	Schwarzbeck	BBHA 9170	9170-181	2020.05.11	2021.05.10	1 year
Test Cable (30MHz-1GHz)	N/A	R-01	N/A	2019.08.06	2022.08.05	3 year
Test Cable (1-18GHz)	N/A	R-02	N/A	2019.08.06	2022.08.05	3 year
50Ω Coaxial Switch	Anritsu	MP59B	6200983705	2020.05.11	2023.05.10	3 year
Pre-Amplifier	EMC	EMC051835S E	980246	2020.07.13	2021.07.12	1 year
Spectrum Analyzer	Agilent	E4407B	MY45108040	2020.05.11	2021.05.10	1 year
Filter	TRILTHIC	2400MHz	29	2020.04.07	2023.04.06	3 year
Attenuator	Weinschel	33-10-33	AR4010	2020.04.07	2023.04.06	3 year
Attenuator	Weinschel	24-20-34	BP4485	2020.04.07	2023.04.06	3 year
MXA Signal Analyzer	Agilent	N9020A	MY49100060	2020.07.13	2021.07.12	1 year
ESG VETCTOR SIGNAL GENERAROR	Agilent	E4438C	MY45093347	2020.05.11	2021.05.10	1 year
PSG Analog Signal Generator	Agilent	E8257D	MY51110112	2020.07.13	2021.07.12	1 year
Power Splitter	Mini-Circuits/USA	ZN2PD-63-S+	SF025101428	2020.04.07	2023.04.06	3 year
Coupler	Mini-Circuits	ZADC-10-63-S+	SF794101410	2020.04.07	2023.04.06	3 year
Directional Coupler	MCLI/USA	CB11-20	0D2L51502	2020.07.17	2023.07.16	3 year
Attenuator	Agilent	8495B	MY42147029	2020.04.07	2023.04.07	3 year
Power Meter	DARE	RPR3006W	15I00041SNO 84	2020.07.13	2021.07.12	1 year
Wideband Radio Communication Tester Specifications	R&S	CMW500	148500	2020.05.11	2021.05.10	1 year
temporary antenna connector (Note)	NTS	R001	N/A	N/A	N/A	N/A

Note:

We will use the temporary antenna connector (soldered on the PCB board) When conducted test And this temporary antenna connector is listed within the instrument list

2. SUMMARY OF TEST RESULTS

The EUT has been tested according to the following specifications:

EN 300 328 V2.2.2 (2019-07)		
Clause	Test Item	Results
TRANSMITTER PARAMETERS		
4.3.2.2	RF Output Power	Pass
4.3.2.3	Power Spectral Density	Pass
4.3.2.4	Duty cycle, Tx-Sequence, Tx-gap	Not Applicable (See Note 1/2)
4.3.2.5	Medium Utilization (MU) factor	Not Applicable (See Note 1/2)
4.3.2.6	Adaptivity	Not Applicable (See Note 1)
4.3.2.7	Occupied Channel Bandwidth	Pass
4.3.2.8	Transmitter unwanted emission in the OOB domain	Pass
4.3.2.9	Transmitter unwanted emissions in the spurious domain	Pass
RECEIVER PARAMETERS		
4.3.2.10	Receiver Spurious Emissions	Pass
4.3.2.11	Receiver Blocking	Pass

Note:

1. These requirements do not apply for equipment with a maximum declared RF output power of less than 10 dBm EIRP or for equipment when operating in a mode where the RF output power is less than 10 dBm EIRP.
2. These requirements apply to non-adaptive frequency hopping equipment or to adaptive frequency hopping equipment operating in a non-adaptive mode

2.1 TEST FACILITY

Shenzhen NTEK Testing Technology Co., Ltd.

Add. : 1/F, Building E, Fenda Science Park, Sanwei Community, Xixiang Street, Bao'an District, Shenzhen 518126 P.R. China

FCC Registered No.: 463705 IC Registered No.:9270A-1

CNAS Registration No.:L5516

2.2 MEASUREMENT UNCERTAINTY

For the test methods, according to ETSI EN 300 328 standard, the measurement uncertainty figures shall be calculated in accordance with ETR 100 028-1[4] and shall correspond to an expansion factor(coverage factor) $k=1.96$ or $k=2$ (which provide confidence levels of respectively **95 %** and **95.45 %** in the case where the distributions characterizing the actual measurement uncertainties are normal (Gaussian)).

Measurement uncertainty

No.	Item	Uncertainty (P=95)
1	Occupied Channel Bandwidth	$\pm 4.7\%$
2	RF output Power,conducted	$\pm 0.9\text{dB}$
3	Power Spectral Density, conducted	$\pm 2.6\text{dB}$
4	Unwanted emissions, conducted	$\pm 2.2\text{dB}$
5	All emissions,radiated	$\pm 5.3\text{dB}$
6	Temperature	$\pm 0.5\text{C}$
7	Humidity	$\pm 2.0\%$
8	Time	$\pm 1.0\%$

3. TEST PROCEDURES AND RESULTS

3.1 EQUIVALENT ISOTROPIC RADIATED POWER

3.1.1 LIMITS OF EQUIVALENT ISOTROPIC RADIATED POWER

Refer to chapter 4.3.2.2.3 of ETSI EN 300 328 V2.2.2 (2019-07)

RF OUTPUT POWER	
Condition	Limit
<input type="checkbox"/> Non-adaptive wide band modulations systems	Equal to or less than the value declared by the supplier. This declared value shall be equal to or less than 20 dBm.
<input checked="" type="checkbox"/> Adaptive wide band modulations systems	≤20dBm

3.1.2 TEST PROCEDURE

Refer to chapter 5.4.2.2 of ETSI EN 300 328 V2.2.2 (2019-07)

Measurement	
<input checked="" type="checkbox"/> Conducted measurement	<input type="checkbox"/> Radiated measurement

3.1.3 TEST SETUP

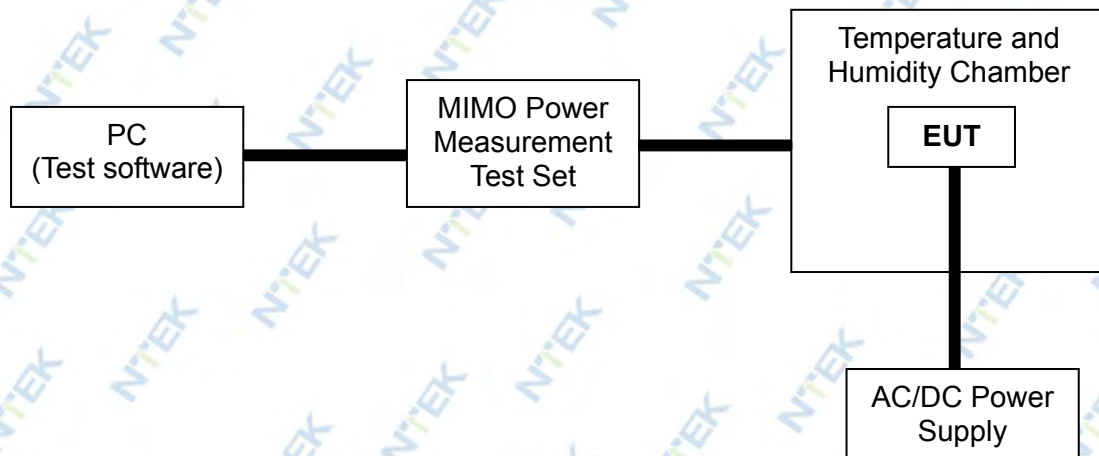

3.1.4 TEST RESULTS

EUT :	Mobile Phone	Model Name :	BV6600
Temperature :	20℃	Relative Humidity:	55 %
Pressure :	1012 hPa	Test Voltage :	DC 3.85V
Test Mode :	TX Low channel / Middle Channel / High Channel		

Test data reference attachment

3.2. PEAK POWER DENSITY

3.2.1 LIMITS OF POWER SPECTRAL DENSITY

Refer to chapter 4.3.2.3.3 of ETSI EN 300 328 V2.2.2 (2019-07)

RF OUTPUT POWER	
Condition	Limit
For equipment using wide band modulations other than FHSS	≤10 dBm/MHz

3.2.2 TEST PROCEDURE

Refer to chapter 5.4.3.2 of ETSI EN 300 328 V2.2.2 (2019-07)

Measurement	
<input checked="" type="checkbox"/> Conducted measurement	<input type="checkbox"/> Radiated measurement

The setting of the Spectrum Analyzer

Start Frequency	2400MHz
Stop Frequency	2483.5MHz
Detector	RMS
Sweep Point	> 8 350; for spectrum analysers not supporting this number of sweep points, the frequency band may be segmented
Sweep time:	For non-continuous transmissions: 2 × Channel Occupancy Time × number of sweep points For continuous transmissions: 10 s; the sweep time may be increased further until a value where the sweep time has no further impact anymore on the RMS value of the signal.
RBW / VBW	10KHz / 30KHz

3.2.3 TEST SETUP

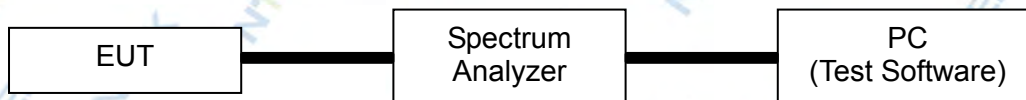

3.2.4 TEST RESULTS

EUT :	Mobile Phone	Model Name :	BV6600
Temperature :	26℃	Relative Humidity:	60 %
Pressure :	1012 hPa	Test Voltage :	DC 3.85V
Test Mode :	TX-GFSK(CH00/CH19/CH39)		

Test data reference attachment

3.3. OCCUPIED CHANNEL BANDWIDTH

3.3.1 LIMITS OF OCCUPIED CHANNEL BANDWIDTH

Refer to chapter 4.3.2.7.3 of ETSI EN 300 328 V2.2.2 (2019-07)

OCCUPIED CHANNEL BANDWIDTH		
Condition		Limit
All types of equipment using wide band modulations other than FHSS		Shall fall completely within the band 2400 to 2483.5 MHz
Additional requirement	For non-adaptive using wide band modulations other than FHSS system and E.I.R.P >10 dBm	Less than 20 MHz
	For non-adaptive frequency hopping system and E.I.R.P >10 dBm	Less than 5 MHz

3.3.2 TEST PROCEDURE

Refer to chapter 5.4.7.2 of ETSI EN 300 328 V2.2.2 (2019-07)

Measurement	
<input checked="" type="checkbox"/> Conducted measurement	<input type="checkbox"/> Radiated measurement

The setting of the Spectrum Analyzer

Center Frequency	The centre frequency of the channel under test
Frequency Span	2 × Nominal Channel Bandwidth
Detector	RMS
RBW	~ 1 % of the span without going below 1 %
VBW	3 × RBW
Trace	Max hold
Sweep time	1s

3.3.3 DEVIATION FROM TEST STANDARD

No deviation

3.3.4 TEST SETUP



These measurements only were performed at normal test conditions. The measurement shall be performed only on the lowest and the highest frequency within the ststed frequency range. In case of conducted measurements the transmitter shall be connected to the measuring equipment via a suitable attenuator. Controlling software has been activated to set the EUT on specific status.

3.3.5 TEST RESULTS

EUT :	Mobile Phone	Model Name :	BV6600
Temperature :	26°C	Relative Humidity :	60 %
Pressure :	1012 hPa	Test Voltage :	DC 3.85V
Test Mode :	TX-GFSK(CH00/CH39)		

Test data reference attachment

3.4. TRANSMITTER UNWANTED EMISSIONS IN THE OUT-OF-BAND DOMAIN

3.4.1 LIMITS OF TRANSMITTER UNWANTED EMISSIONS IN THE OUT-OF-BAND DOMAIN

Refer to chapter 4.3.2.8.3 of ETSI EN 300 328 V2.2.2 (2019-07)

TRANSMITTER UNWANTED EMISSIONS IN THE OUT-OF-BAND DOMAIN	
Condition	Limit
Under all test conditions	The transmitter unwanted emissions in the out-of-band domain but outside the allocated band, shall not exceed the values provided by the mask in below figure.

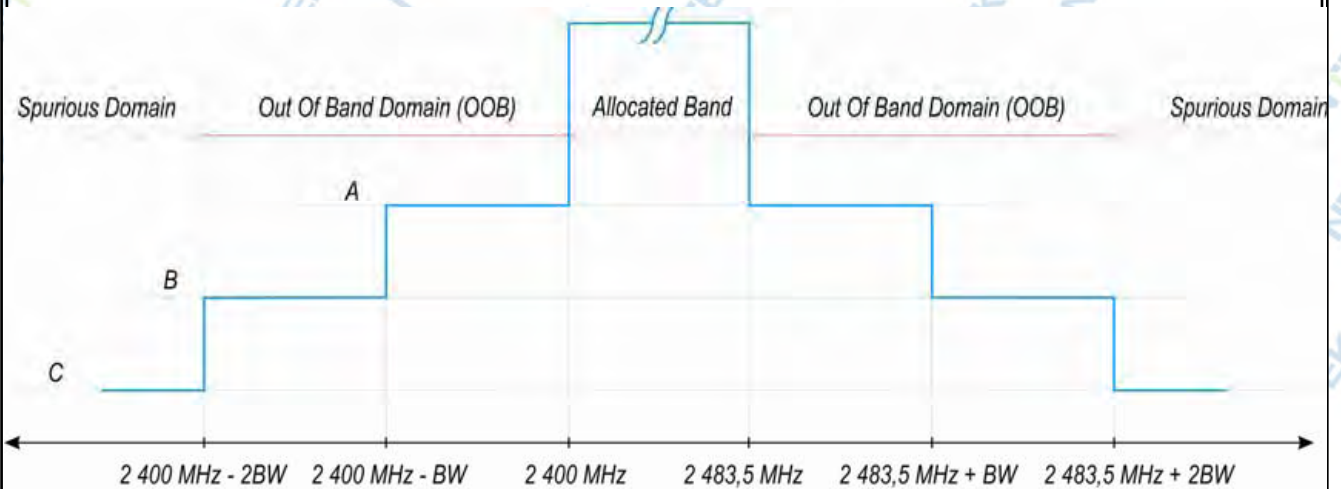

- A: -10 dBm/MHz e.i.r.p.
- B: -20 dBm/MHz e.i.r.p.
- C: Spurious Domain limits

BW = Occupied Channel Bandwidth in MHz or 1 MHz whichever is greater

3.4.2 TEST PROCEDURE

Refer to chapter 5.4.8.2 of ETSI EN 300 328 V2.2.2 (2019-07)

Measurement	
<input checked="" type="checkbox"/> Conducted measurement	<input type="checkbox"/> Radiated measurement

The setting of the Spectrum Analyzer

Span	0Hz
Filter Mode	Channel Filter
Trace Mode	Max Hold
Trigger Mode	Video trigger; in case video triggering is not possible, an external trigger source may be used
Detector	RMS
Sweep Point / Sweep Mode	Sweep Time [s] / (1 μs) or 5 000 whichever is greater/ Continuous
RBW / VBW	1MHz / 3MHz

3.4.3 DEVIATION FROM TEST STANDARD

No deviation

3.4.4 TEST SETUP

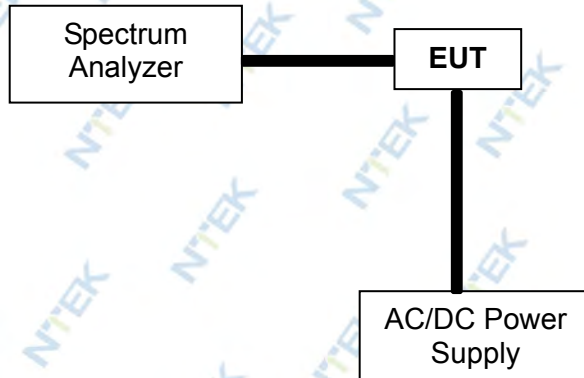

According to the EN 300328 V2.2.2 clause 5.4.8.1: These measurements shall only be performed at normal test conditions. For equipment using FHSS modulation, the measurements shall be performed during normal operation (hopping).

For equipment using wide band modulations other than FHSS, the measurement shall be performed at the lowest and the highest channel on which the equipment can operate. These operating channels shall be recorded.

The equipment shall be configured to operate under its worst case situation with respect to output power.

If the equipment can operate with different Nominal Channel Bandwidths (e.g. 20 MHz and 40 MHz), then each channel bandwidth shall be tested separately.

3.4.5 TEST RESULTS

EUT :	Mobile Phone	Model Name :	BV6600
Temperature :	24 °C	Relative Humidity :	54%
Pressure :	1010 hPa	Test Power :	DC 3.85V
Test Mode :	TX-GFSK(CH00/CH39)		

Test data reference attachment

3.5. ADAPTIVE (CHANNEL ACCESS MECHANISM)

3.5.1 APPLICABILITY OF ADAPTIVE REQUIREMENTS AND LILIT FOR WIDE BAND MODULATION TECHNIQUES

Refer to chapter 4.3.2.6 of ETSI EN 300 328 V2.2.2 (2019-07)

Requirement	Operational Mode			
	<input type="checkbox"/> Non-LBT based Detect and Avoid	<input type="checkbox"/> LBT based Detect and Avoid		
		<input type="checkbox"/> Frame Based Equipment	<input type="checkbox"/> Load Based Equipment (CCA using 'energy detect')	<input type="checkbox"/> Load Based Equipment (CCA not using any of the mechanisms referenced as note 2)
Minimum Clear Channel Assessment (CCA) Time	NA	not less than 18 us (see note 1)	(see note 2)	not less than 18 us (see note 1)
Maximum Channel Occupancy (COT) Time	< 40 ms	1ms to 10 ms	(see note 2)	(13/32)*q ms (see note 3)
Minimum Idle Period	5 % minimum of 100 μs	5% of COT	(see note 2)	NA
Extended CCA check	NA	NA	(see note 2)	R*CCA (see note 4)
Short Control Signalling Transmissions	Maximum duty cycle of 10% within an observation period of 50 ms (see note 5)			

- Note 1: The CCA time used by the equipment shall be declared by the supplier.
- Note 2: Load Based Equipment may implement an LBT based spectrum sharing mechanism based on the Clear Channel Assessment (CCA) mode using energy detect as described in IEEE 802.11™-2012 [i.3], clause 9, clause 10, clause 16, clause 17, clause 19 and clause 20, or in IEEE 802.15.4™-2011 [i.4], clause 4, clause 5 and clause 8 providing the equipment complies with the conformance requirements referred to in clause 4.3.2.6.3.4.
- Note 3: q is selected by the manufacturer in the range [4...32]
- Note 4: The value of R shall be randomly selected in the range [1...q]
- Note 5: Adaptive equipment may or may not have Short Control Signaling Transmissions.

Interference threshold level

The detection threshold shall be proportional to the transmit power of the transmitter: for a 20 dBm e.i.r.p. transmitter the detection threshold level (TL) shall be equal to or less than -70 dBm/MHz at the input to the receiver assuming a 0 dBi (receive) antenna assembly. This threshold level (TL) may be corrected for the (receive) antenna assembly gain (G); however, beamforming gain (Y) shall not be taken into account. For power levels less than 20 dBm e.i.r.p., the detection threshold level may be relaxed to:

$$TL = -70 \text{ dBm/MHz} + 10 \times \log_{10} (100 \text{ mW} / P_{out}) \text{ (P}_{out} \text{ in mW e.i.r.p.)}$$

Table 9: Unwanted Signal parameters

Wanted signal mean power from companion device (dBm)	Unwanted signal frequency (MHz)	Unwanted CW signal power (dBm)
-30/ sufficient to maintain the link(see note 2)	2 395 or 2 488,5 (see note 1)	-35 (see note 2)

NOTE 1: The highest frequency shall be used for testing operating channels within the range 2 400 MHz to 2 442 MHz, while the lowest frequency shall be used for testing operating channels within the range 2 442 MHz to 2 483,5 MHz. See clause 5.4.6.1.

NOTE 2: A typical value which can be used in most cases is -50 dBm/MHz.

NOTE 3: The level specified is the level in front of the UUT antenna. In case of conducted measurements, this level has to be corrected by the actual antenna assembly gain.

3.5.2 TEST PROCEDURE

Refer to chapter 5.4.6.2 of ETSI EN 300 328 V2.2.2 (2019-07)

Measurement	
<input checked="" type="checkbox"/> Conducted measurement	<input type="checkbox"/> Radiated measurement

Test method please refer to the 5.4.6.2.1.4 of ETSI EN 300 328 V2.2.2 (2019-07).

3.5.3 TEST SETUP CONFIGURATION

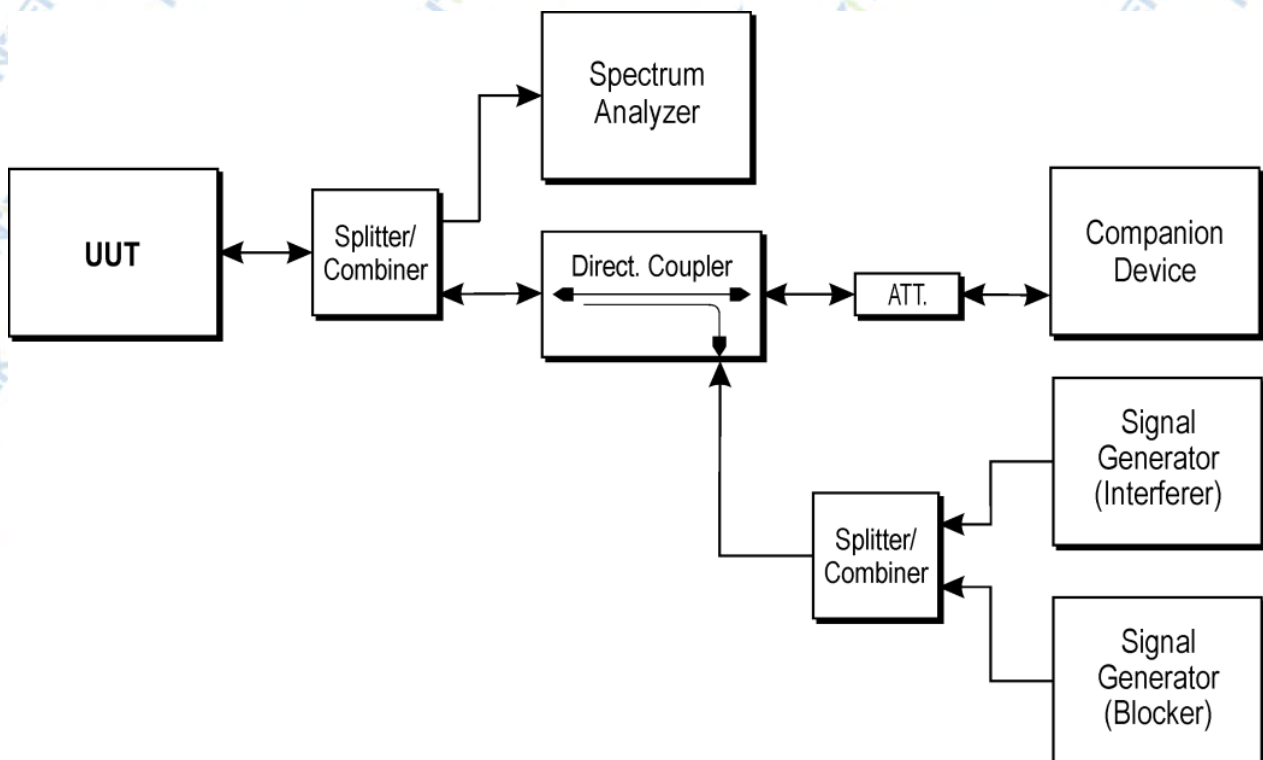

3.5.4 LIST OF MEASUREMENTS

UUT operational Mode		
Frame Based Equipment	Load Based Equipment (CCA using 'energy detect')	Load Based Equipment (CCA not using any of the mechanisms referenced)
	V	

Clause	Test Parameter	Remarks	PASS/FAIL
4.3.2.5.2.2.1	Adaptive (Frame Based Equipment)	Not Applicable	N/A
4.3.2.5.2.2.2	Adaptive (Load Based Equipment)	N/A	N/A
4.3.2.5.3	Short Control Signaling Transmissions	N/A	N/A

3.5.5 TEST RESULTS

EUT :	Mobile Phone	Model Name :	BV6600
Temperature :	24 °C	Relative Humidity :	54%
Pressure :	1010 hPa	Test Power :	N/A
Test Mode :	N/A		

Note: Not applicable

3.6. TRANSMITTER UNWANTED EMISSIONS IN THE SPURIOUS DOMAIN

3.6.1 LIMITS OF TRANSMITTER UNWANTED EMISSIONS IN THE SPURIOUS DOMAIN

Refer to chapter 4.3.2.9.3 of ETSI EN 300328 V2.2.2 (2019-07)

TRANSMITTER UNWANTED EMISSIONS IN THE SPURIOUS DOMAIN		
Frequency Range	Maximum Power Limit (E.R.P.(≤1 GHz) E.I.R.P.(> 1 GHz))	Bandwidth
30 MHz to 47 MHz	-36dBm	100 kHz
47 MHz to 74 MHz	-54dBm	100 kHz
74 MHz to 87.5 MHz	-36dBm	100 kHz
87.5 MHz to 118 MHz	-54dBm	100 kHz
118 MHz to 174 MHz	-36dBm	100 kHz
174 MHz to 230 MHz	-54dBm	100 kHz
230 MHz to 470 MHz	-36dBm	100 kHz
470 MHz to 694 MHz	-54dBm	100 kHz
694 MHz to 1 GHz	-36dBm	100 kHz
1 GHz ~ 12.75 GHz	-30dBm	1 MHz

3.6.2 TEST PROCEDURE

Refer to chapter 5.4.9.2 of ETSI EN 300328 V2.2.2 (2019-07)

Measurement	
<input checked="" type="checkbox"/> Conducted measurement	<input checked="" type="checkbox"/> Radiated measurement

The setting of the Spectrum Analyzer

RBW	100K(<1GHz) / 1M(>1GHz)
VBW	300K(<1GHz) / 3M(>1GHz)

3.6.3 DEVIATION FROM TEST STANDARD

No deviation

3.6.4 TEST SETUP

Radiated measurement:

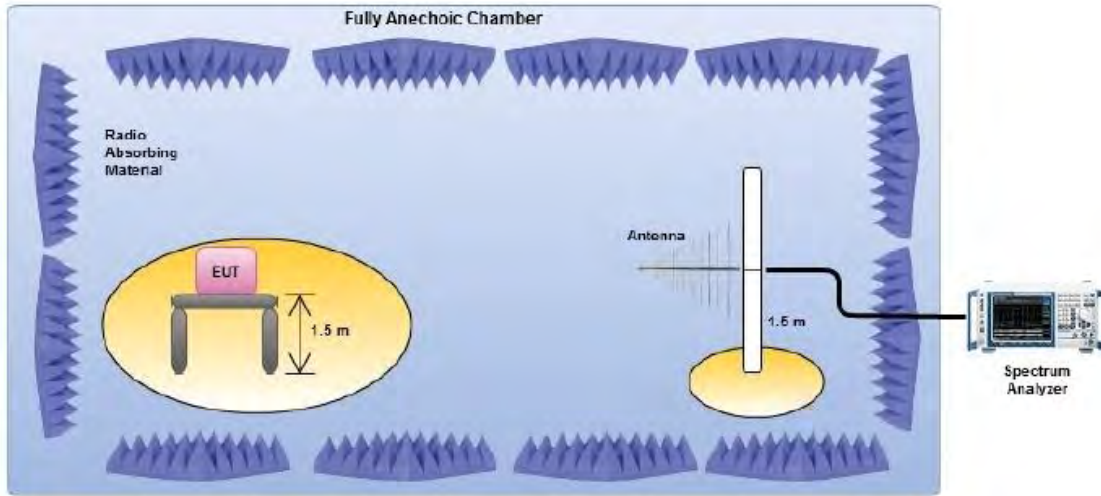

Conducted measurement:



1. For the actual test configuration, please refer to the related Item in this test report (Photographs of the Test Configuration).
2. The measurements were performed when normal hopping was disabled. In this case measurements were performed when operating at the lowest and the highest hopping frequency.
3. The equipment was configured to operate under its worst case situation with respect to output power.
4. The test setup has been constructed as the normal use condition. Controlling software has been activated to set the EUT on specific status.

3.6.5 TEST RESULTS(Radiated measurement)

BELOW 1 GHz WORST- CASE DATA(30 MHz ~ 1GHz)

EUT :	Mobile Phone	Model Name :	BV6600
Temperature :	26°C	Relative Humidity :	60 %
Pressure :	1012 hPa	Test Voltage :	DC 3.85V
Test Mode :	TX--GFSK(CH39)		

Polar (H/V)	Frequency	Meter Reading	Factor	Emission Level	Limits	Margin	Remark
	(MHz)	(dBm)	(dB)	(dBm)	(dBm)	(dB)	
V	32.80	-75.90	11.08	-64.82	-36	-28.82	peak
V	94.25	-69.58	9.95	-59.63	-54	-5.63	peak
V	183.22	-76.31	11.04	-65.27	-54	-11.27	peak
V	298.50	-73.90	9.57	-64.33	-36	-28.33	peak
V	594.09	-72.14	10.86	-61.28	-54	-7.28	peak
H	38.24	-70.76	10.51	-60.25	-36	-24.25	peak
H	102.09	-71.26	9.86	-61.40	-54	-7.40	peak
H	194.26	-76.90	9.67	-67.23	-54	-13.23	peak
H	442.26	-69.74	11.36	-58.38	-36	-22.38	peak
H	591.74	-70.98	10.32	-60.66	-54	-6.66	peak

Remark:

1. Emission Level= Meter Reading+ Factor, Margin= Emission Level- Limit.
- 2.All the modes had been tested, but only the worst data recorded in the report.

ABOVE 1 GHz WORST- CASE DATA (1GHz ~ 12.75GHz)

EUT :	Mobile Phone	Model Name :	BV6600
Temperature :	26°C	Relative Humidity :	60 %
Pressure :	1012 hPa	Test Voltage :	DC 3.85V
Test Mode :	TX-GFSK (CH00/CH19/CH39)		

Polar (H/V)	Frequency	Meter Reading	Factor	Emission Level	Limits	Margin	Remark
	(MHz)	(dBm)	(dB)	(dBm)	(dBm)	(dB)	
operation frequency:2402							
V	2151.954	-73.84	10.04	-63.80	-30	-33.80	peak
V	4677.445	-71.03	9.58	-61.45	-30	-31.45	peak
V	2961.416	-68.37	10.53	-57.84	-30	-27.84	peak
V	3390.814	-74.85	10.65	-64.20	-30	-34.20	peak
H	2891.692	-67.8	10.83	-56.97	-30	-26.97	peak
H	5980.62	-73.22	11.07	-62.15	-30	-32.15	peak
H	2650.496	-75.16	10.74	-64.42	-30	-34.42	peak
H	5567.425	-73.74	11.31	-62.43	-30	-32.43	peak
operation frequency:2440							
V	2313.074	-67.75	10.97	-56.78	-30	-26.78	peak
V	4767.114	-74.62	9.77	-64.85	-30	-34.85	peak
V	2179.556	-74.89	11.48	-63.41	-30	-33.41	peak
V	5088.739	-69.84	10.84	-59.00	-30	-29.00	peak
H	2231.642	-76.31	9.93	-66.38	-30	-36.38	peak
H	5653.815	-75.73	11.34	-64.39	-30	-34.39	peak
H	2543.785	-70.48	9.65	-60.83	-30	-30.83	peak
H	4858.386	-76.5	9.59	-66.91	-30	-36.91	peak
operation frequency:2480							
V	2700.807	-70.08	9.93	-60.15	-30	-30.15	peak
V	4987.83	-74.37	10.19	-64.18	-30	-34.18	peak
V	2535.525	-72.82	10.59	-62.23	-30	-32.23	peak
V	4913.512	-68.33	11.39	-56.94	-30	-26.94	peak
H	2024.246	-73.81	9.99	-63.82	-30	-33.82	peak
H	3303.454	-67.52	11.47	-56.05	-30	-26.05	peak
H	2423.927	-71.71	10.96	-60.75	-30	-30.75	peak
H	3554.9	-73.91	10.50	-63.41	-30	-33.41	peak

Remark:

1. Emission Level= Meter Reading+ Factor, Margin= Emission Level- Limit.
2. All the modes had been tested, but only the worst data recorded in the report.

3.6.6 TEST RESULTS (Conducted measurement)

Test data reference attachment

3.7. RECEIVER SPURIOUS RADIATION

3.7.1 LIMITS OF RECEIVER SPURIOUS RADIATION

Refer to chapter 4.3.2.10.3 of ETSI EN 300 328 V2.2.2 (2019-07)

RECEIVER SPURIOUS EMISSIONS		
Frequency Range	Maximum Power Limit (E.R.P.(≤1 GHz) E.I.R.P.(> 1 GHz))	Measurement Bandwidth
30 MHz ~ 1 GHz	-57dBm	100KHz
1 GHz ~ 12.75 GHz	-47dBm	1MHz

3.7.2 TEST PROCEDURE

Refer to chapter 5.4.10.2 of ETSI EN 300 328 V2.2.2 (2019-07)

Measurement	
<input checked="" type="checkbox"/> Conducted measurement	<input checked="" type="checkbox"/> Radiated measurement

The setting of the Spectrum Analyzer

RBW	100K(<1GHz) / 1M(>1GHz)
VBW	300K(<1GHz) / 3M(>1GHz)

3.7.3 DEVIATION FROM TEST STANDARD

No deviation

3.7.4 TEST SETUP

Radiated measurement:

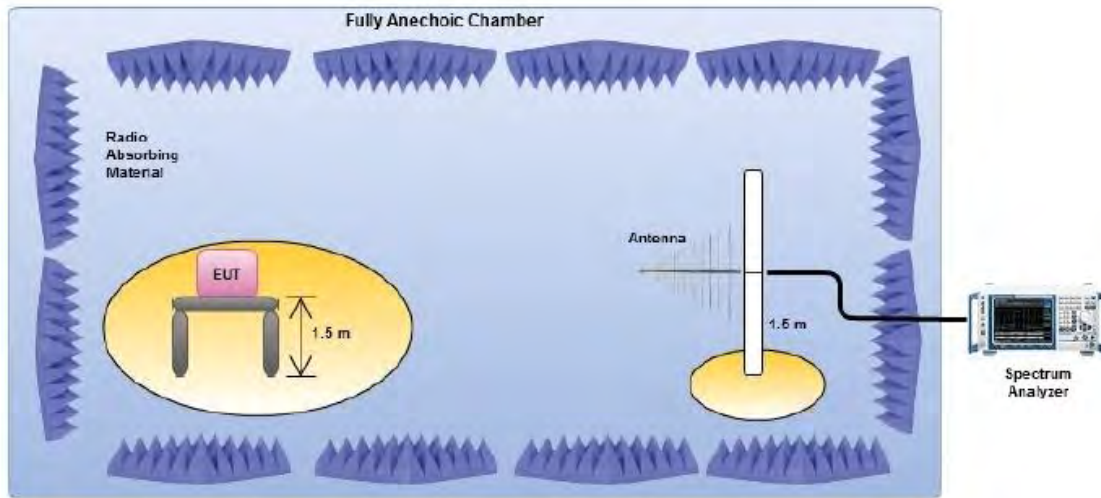

Conducted measurement:

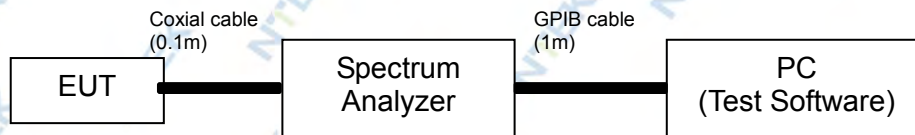

1. For the actual test configuration, please refer to the related Item in this test report (Photographs of the Test Configuration).
2. Testing was performed when the equipment was in a receive-only mode.
3. The measurements were performed when normal hopping was disabled. In this case measurements were performed when operating at the lowest and the highest hopping frequency.
4. The test setup has been constructed as the normal use condition. Controlling software has been activated to set the EUT on specific status.

3.7.5 TEST RESULTS(Radiated measurement)

RX BELOW 1 GHz WORST- CASE DATA(30 MHz ~ 1GHz)

EUT :	Mobile Phone	Model Name :	BV6600
Temperature :	26°C	Relative Humidity :	60 %
Pressure :	1012 hPa	Test Voltage :	DC 3.85V
Test Mode :	RX Mode-GFSK(CH39)		

Polar (H/V)	Frequency	Meter Reading	Factor	Emission Level	Limits	Margin	Remark
	(MHz)	(dBm)	(dB)	(dBm)	(dBm)	(dB)	
V	38.681	-79.73	12.98	-66.75	-57	-9.75	peak
V	105.856	-81.44	11.67	-69.77	-57	-12.77	peak
V	218.652	-80.08	18.94	-61.14	-57	-4.14	peak
V	385.122	-82.23	11.65	-70.58	-57	-13.58	peak
V	684.348	-80.18	11.45	-68.73	-57	-11.73	peak
H	38.632	-82.39	18.60	-63.79	-57	-6.79	peak
H	109.261	-77.81	18.11	-59.70	-57	-2.70	peak
H	203.966	-77.13	10.30	-66.83	-57	-9.83	peak
H	233.988	-82.98	15.00	-67.98	-57	-10.98	peak
H	638.898	-82.81	14.63	-68.18	-57	-11.18	peak

Remark:

1. Emission Level= Meter Reading+ Factor, Margin= Emission Level- Limit.
2. All the modes had been tested, but only the worst data recorded in the report.

RX ABOVE 1 GHz WORST- CASE DATA(1GHz ~ 12.75GHz)

EUT :	Mobile Phone	Model Name :	BV6600
Temperature :	24 °C	Relative Humidity	54%
Pressure :	1010 hPa	Test Power :	DC 3.85V
Test Mode :	RX Mode-GFSK(CH39)		

Polar (H/V)	Frequency	Meter Reading	Factor	Emission Level	Limits	Margin	Remark
	(MHz)	(dBm)	(dB)	(dBm)	(dBm)	(dB)	
V	2421.697	-78.18	9.94	-68.24	-47	-21.24	peak
V	5338.341	-77.7	9.82	-67.88	-47	-20.88	peak
V	2034.13	-80.64	10.02	-70.62	-47	-23.62	peak
V	3814.863	-79.87	16.13	-63.74	-47	-16.74	peak
H	2052.988	-81	10.11	-70.89	-47	-23.89	peak
H	3090.893	-82.81	10.68	-72.13	-47	-25.13	peak
H	2864.744	-79.94	7.00	-72.94	-47	-25.94	peak
H	4105.183	-80.38	14.56	-65.82	-47	-18.82	peak

1. Emission Level= Meter Reading+ Factor, Margin= Emission Level- Limit.
2. All the modes had been tested, but only the worst data recorded in the report.

3.7.6 TEST RESULTS (Conducted measurement)

Test data reference attachment

3.8. RECEIVER BLOCKING

3.8.1 PERFORMANCE CRITERIA

The minimum performance criterion shall be a PER less than or equal to 10 %. The manufacturer may declare alternative performance criteria as long as that is appropriate for the intended use of the equipment (see clause 5.4.1.t)).

3.8.2 LIMITS OF RECEIVER BLOCKING

While maintaining the minimum performance criteria as defined in clause 4.3.2.11.3, the blocking levels at specified frequency offsets shall be equal to or greater than the limits defined for the applicable receiver category provided in table 14, table 15 or table 16.

Table 14: Receiver Blocking parameters for Receiver Category 1 equipment

Wanted signal mean power from companion device (dBm) (see notes 1 and 4)	Blocking signal Frequency (MHz)	Blocking signal power (dBm) (see note 4)	Type of blocking signal
(-133 dBm + 10 × log ₁₀ (OCBW)) or -68 dBm whichever is less (see note 2)	2 380	-34	CW
	2 504		
(-139 dBm + 10 × log ₁₀ (OCBW)) or -74 dBm whichever is less (see note 3)	2 300		
	2 330		
	2 360		
	2524		
	2584		
	2674		

NOTE 1: OCBW is in Hz.

NOTE 2: In case of radiated measurements using a companion device and the level of the wanted signal from the companion device cannot be determined, a relative test may be performed using a wanted signal up to P_{min} + 26 dB where P_{min} is the minimum level of wanted signal required to meet the minimum performance criteria as defined in clause 4.3.1.12.3 in the absence of any blocking signal.

NOTE 3: In case of radiated measurements using a companion device and the level of the wanted signal from the companion device cannot be determined, a relative test may be performed using a wanted signal up to P_{min} + 20 dB where P_{min} is the minimum level of wanted signal required to meet the minimum performance criteria as defined in clause 4.3.1.12.3 in the absence of any blocking signal.

NOTE 4: The level specified is the level at the UUT receiver input assuming a 0 dBi antenna assembly gain. In case of conducted measurements, this level has to be corrected for the (in-band) antenna assembly gain (G). In case of radiated measurements, this level is equivalent to a power flux density (PFD) in front of the UUT antenna with the UUT being configured/positioned as recorded in clause 5.4.3.2.2.

Table 15: Receiver Blocking parameters receiver category 2 equipment

Wanted signal mean power from companion device (dBm) (see notes 1 and 3)	Blocking signal Frequency (MHz)	Blocking signal power (dBm) (see note 3)	Type of blocking signal
(-139 dBm + 10 × log ₁₀ (OCBW) + 10 dB) or (-74 dBm + 10 dB) whichever is less (see note 2)	2 380	-34	CW
	2 504		
	2 300		
	2 584		

NOTE 1: OCBW is in Hz.

NOTE 2: In case of radiated measurements using a companion device and the level of the wanted signal from the companion device cannot be determined, a relative test may be performed using a wanted signal up to P_{min} + 26 dB where P_{min} is the minimum level of wanted signal required to meet the minimum performance criteria as defined in clause 4.3.1.12.3 in the absence of any blocking signal.

NOTE 3: The level specified is the level at the UUT receiver input assuming a 0 dBi antenna assembly gain. In case of conducted measurements, this level has to be corrected for the (in-band) antenna assembly gain (G). In case of radiated measurements, this level is equivalent to a power flux density (PFD) in front of the UUT antenna with the UUT being configured/positioned as recorded in clause 5.4.3.2.2.

Table 16: Receiver Blocking parameters receiver category 3 equipment

Wanted signal mean power from companion device (dBm)	Blocking signal Frequency (MHz)	Blocking signal power (dBm) (see note 2)	Type of blocking signal
(-139 dBm + 10 × log ₁₀ (OCBW) + 20 dB) or (-74 dBm + 20 dB) whichever is less (see note 2)	2 380	-34	CW
	2 504		
	2 300		
	2 584		

NOTE 1: OCBW is in Hz.

NOTE 2: In case of radiated measurements using a companion device and the level of the wanted signal from the companion device cannot be determined, a relative the test may be performed using a wanted signal up to P_{min} + 30 dB where P_{min} is the minimum level of wanted signal required to meet the minimum performance criteria as defined in clause 4.3.1.12.3 in the absence of any blocking signal.

NOTE 3: The level specified is the level at the UUT receiver input assuming a 0 dBi antenna assembly gain. In case of conducted measurements, this level has to be corrected for the (in-band) antenna assembly gain (G). In case of radiated measurements, this level is equivalent to a power flux density (PFD) in front of the UUT antenna with the UUT being configured/positioned as recorded in clause 5.4.3.2.2.

3.8.3 TEST PROCEDURE

Refer to chapter 5.4.11.2 of ETSI EN 300 328 V2.2.2 (2019-07)

Measurement	
<input checked="" type="checkbox"/> Conducted measurement	<input type="checkbox"/> Radiated measurement

3.8.4 DEVIATION FROM TEST STANDARD

No deviation

3.8.5 TEST SETUP

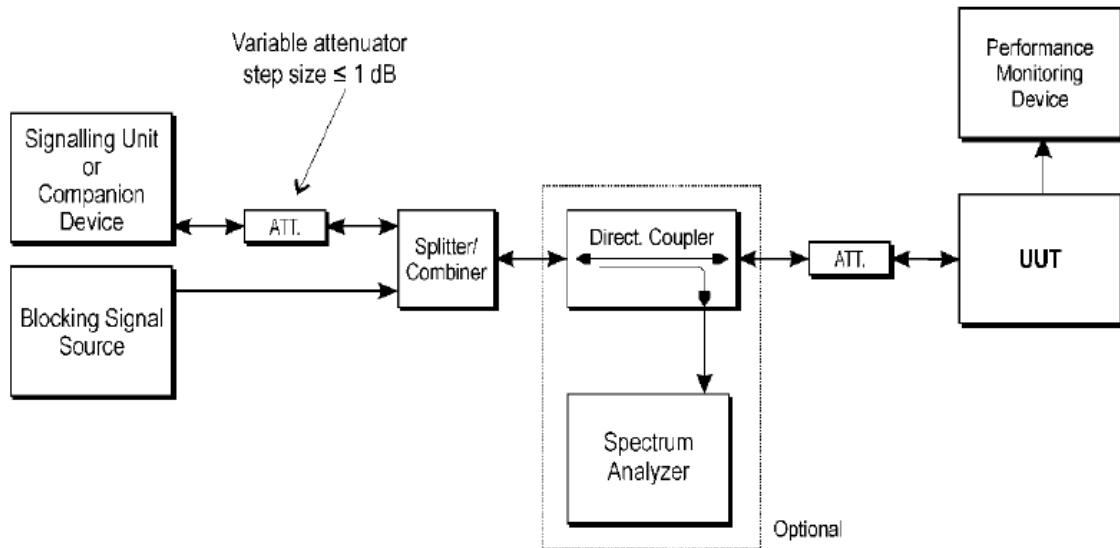

3.8.6 TEST RESULTS

EUT :	Mobile Phone	Model Name :	BV6600
Temperature :	24 °C	Relative Humidity	54%
Pressure :	1010 hPa	Test Power :	DC 3.85V
Test Mode :	GFSK-RX Mode (CH00/CH39)		

CH00:

receiver category 2

Wanted signal mean power from companion device (dBm) <small>Note(1)</small>	Blocking signal Frequency (MHz)	Blocking signal power (dBm)	PER %	PER Limit %
-68.88	2 380	-34	0.29%	≤10%
	2 504		0.43%	
	2 300		0.59%	≤10%
	2 584		0.72%	

CH39:

receiver category 2

Wanted signal mean power from companion device (dBm) <small>Note(1)</small>	Blocking signal Frequency (MHz)	Blocking signal power (dBm)	PER %	PER Limit %
-68.79	2 380	-34	0.38%	≤10%
	2 504		0.45%	
	2 300		0.75%	≤10%
	2 584		0.96%	

Note: (1) The above results were obtained from laboratory tests.

4. TEST RESULTS

1M:

4.1.1 RF OUTPUT POWER

Condition	Mode	Frequency (MHz)	Max Burst RMS Power (dBm)	Burst Number	Max EIRP (dBm)	Limit (dBm)	Verdict
NVNT	BLE	2402	2.07	501	2.87	20	Pass
NVNT	BLE	2440	3.17	501	3.97	20	Pass
NVNT	BLE	2480	3.05	160	3.85	20	Pass
NVLT	BLE	2402	1.22	501	2.02	20	Pass
NVLT	BLE	2440	2.39	501	3.19	20	Pass
NVLT	BLE	2480	2.51	160	3.31	20	Pass
NVHT	BLE	2402	1.16	501	1.96	20	Pass
NVHT	BLE	2440	2.49	501	3.29	20	Pass
NVHT	BLE	2480	2.71	160	3.51	20	Pass

Power NVNT BLE 2402MHz

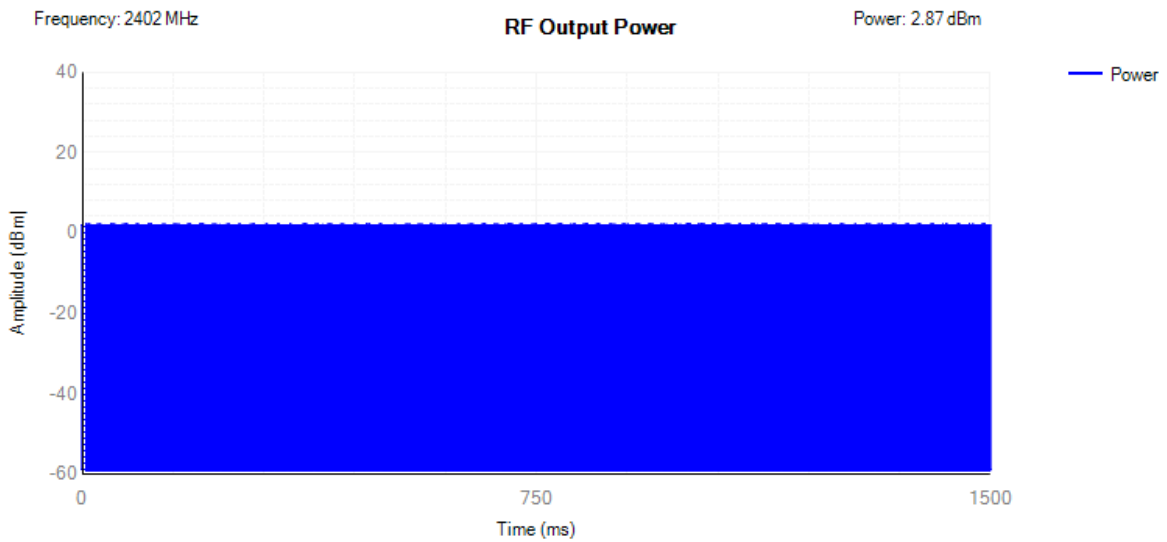

Power NVNT BLE 2440MHz

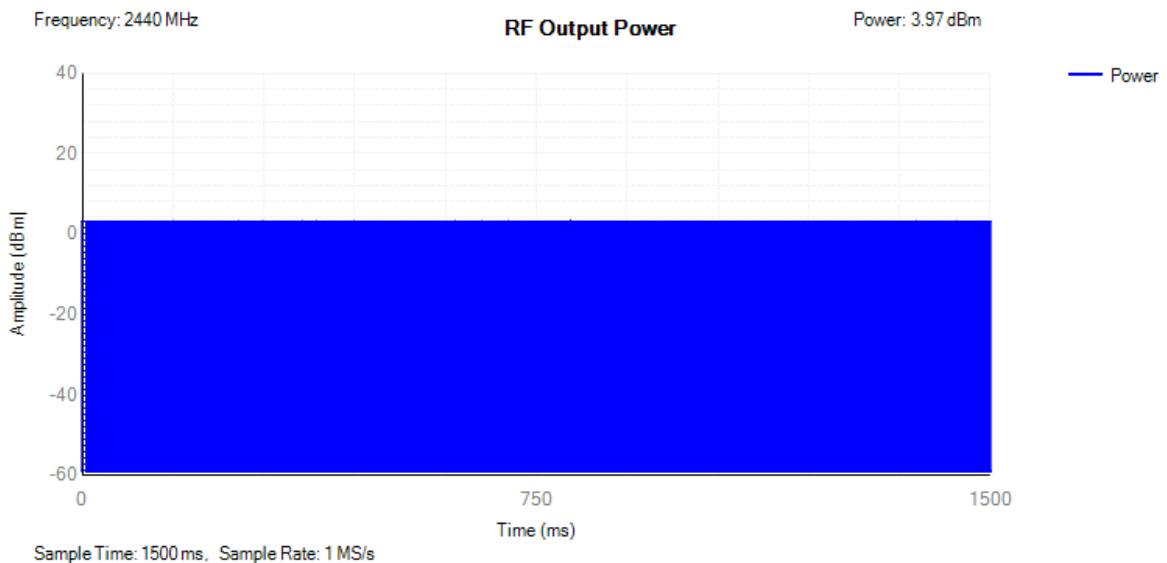

Power NVNT BLE 2480MHz

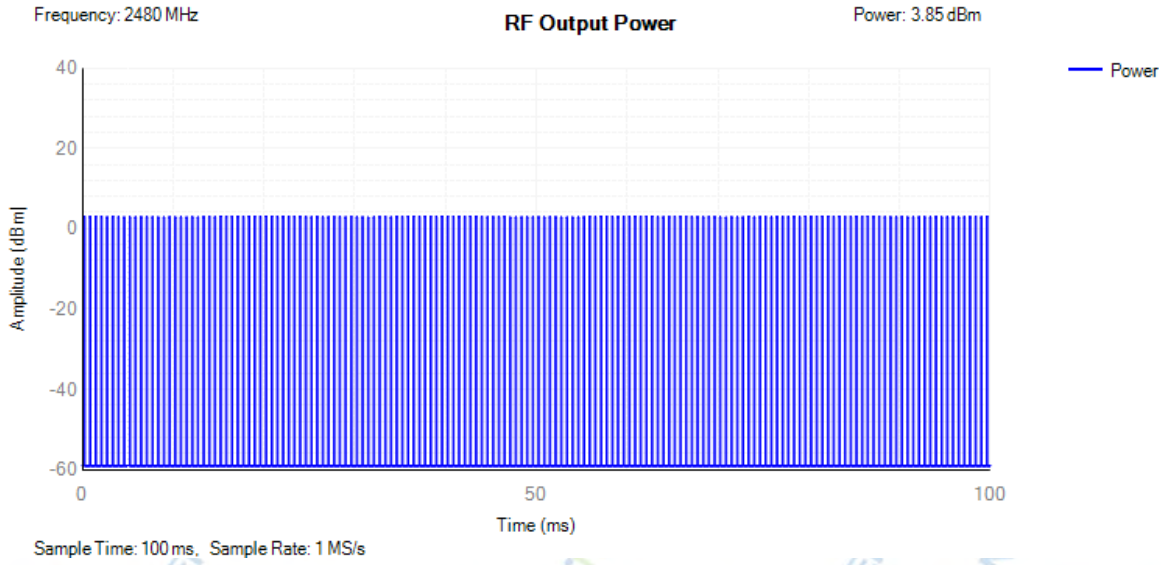

4.1.2 POWER SPECTRAL DENSITY

Condition	Mode	Frequency (MHz)	Max PSD (dBm/MHz)	Limit (dBm/MHz)	Verdict
NVNT	BLE	2402	2.8	10	Pass
NVNT	BLE	2440	3.91	10	Pass
NVNT	BLE	2480	3.79	10	Pass

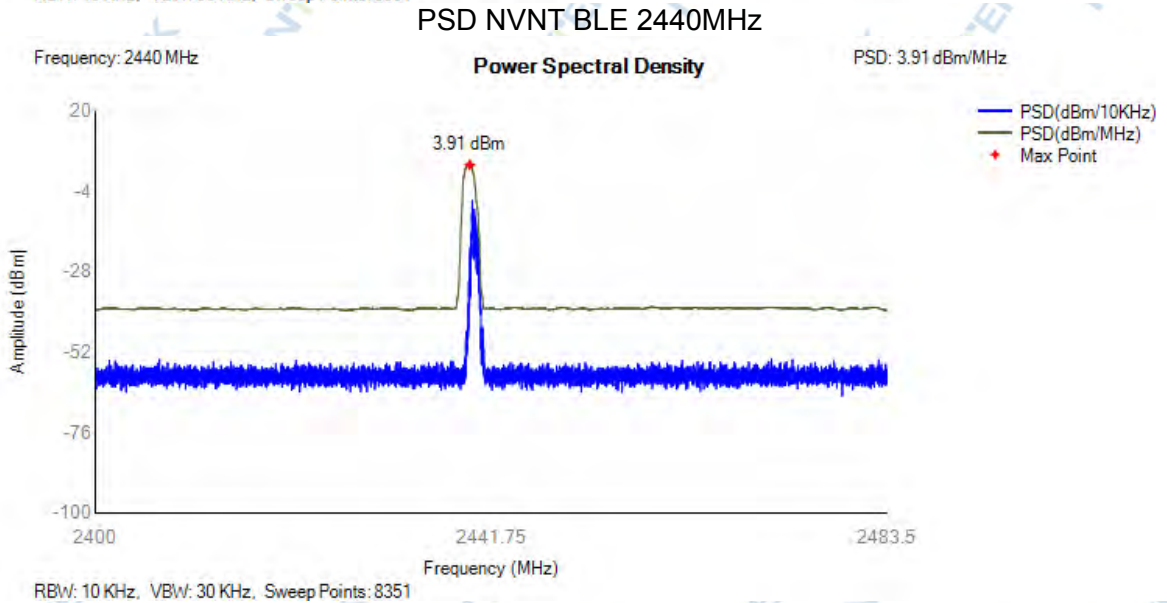
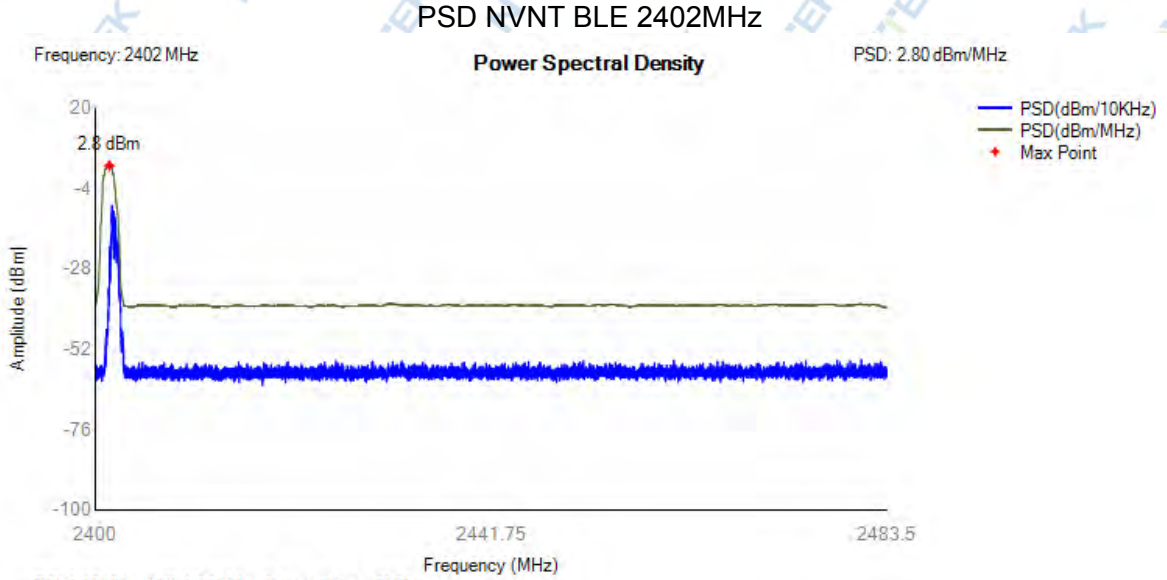

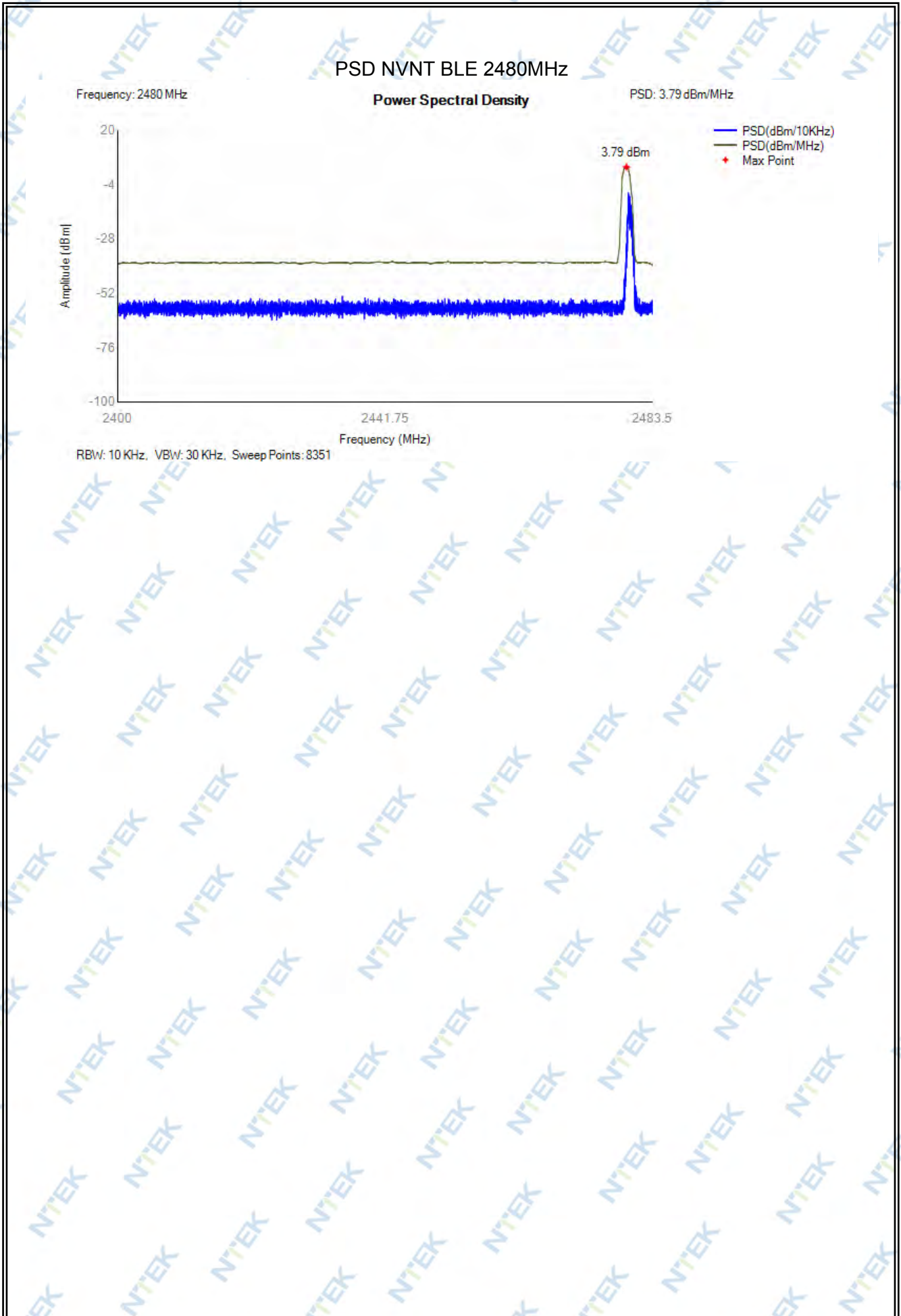

4.1.3 OCCUPIED CHANNEL BANDWIDTH

Condition	Mode	Frequency (MHz)	Center Frequency (MHz)	OBW (MHz)	Lower Edge (MHz)	Upper Edge (MHz)	Limit OBW (MHz)	Verdict
NVNT	BLE	2402	2402.016	1.007	2401.513	2402.519	2400 - 2483.5MHz	Pass
NVNT	BLE	2440	2440.014	1.007	2439.511	2440.517	2400 - 2483.5MHz	Pass
NVNT	BLE	2480	2480.012	1.007	2479.509	2480.515	2400 - 2483.5MHz	Pass

OBW NVNT BLE 2402MHz

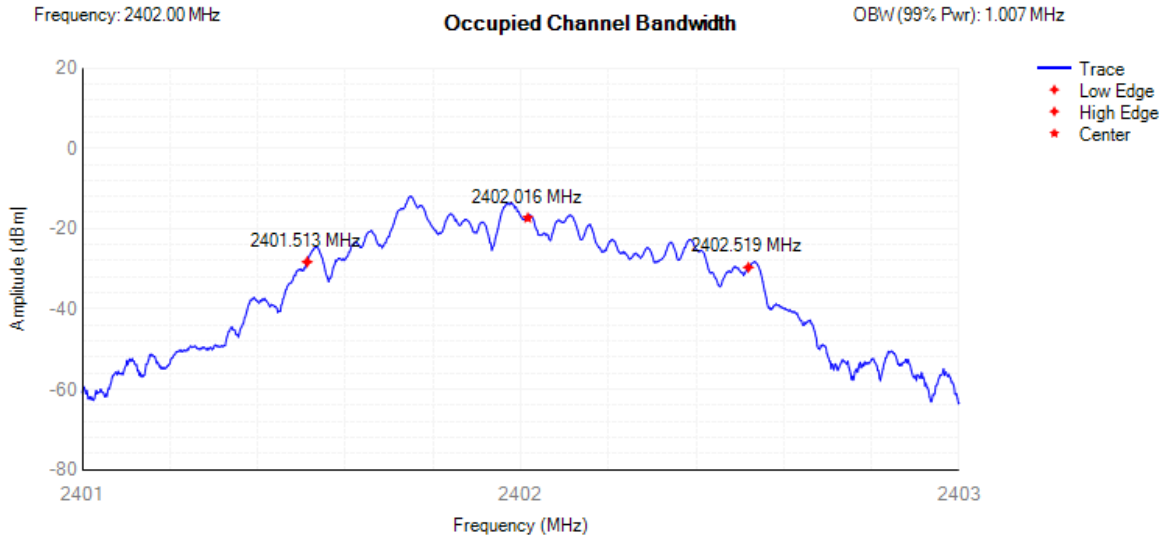

OBW NVNT BLE 2440MHz

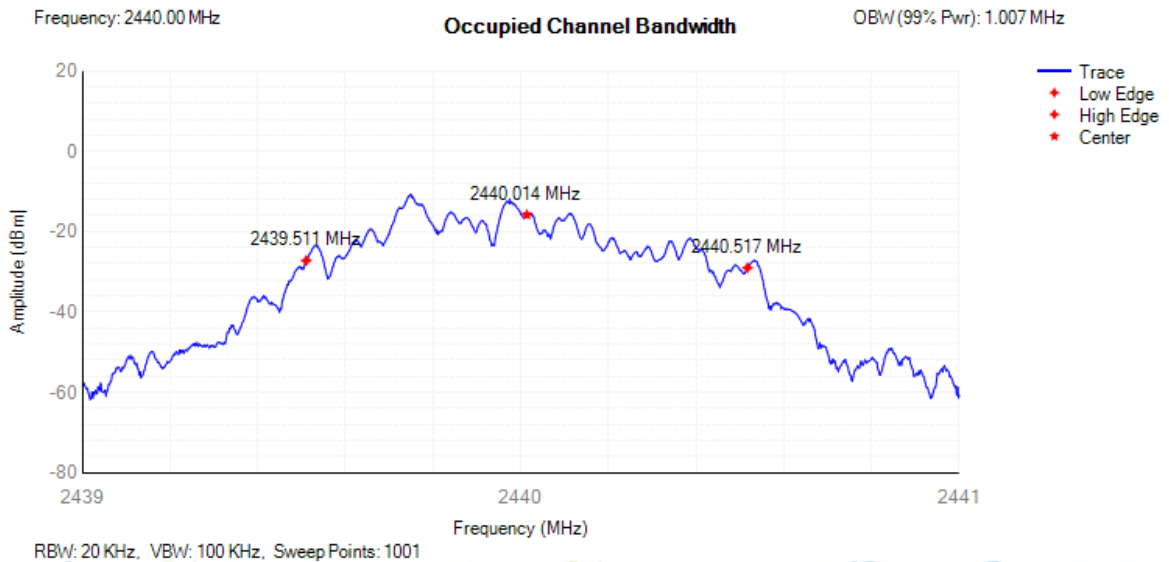

OBW NVNT BLE 2480MHz

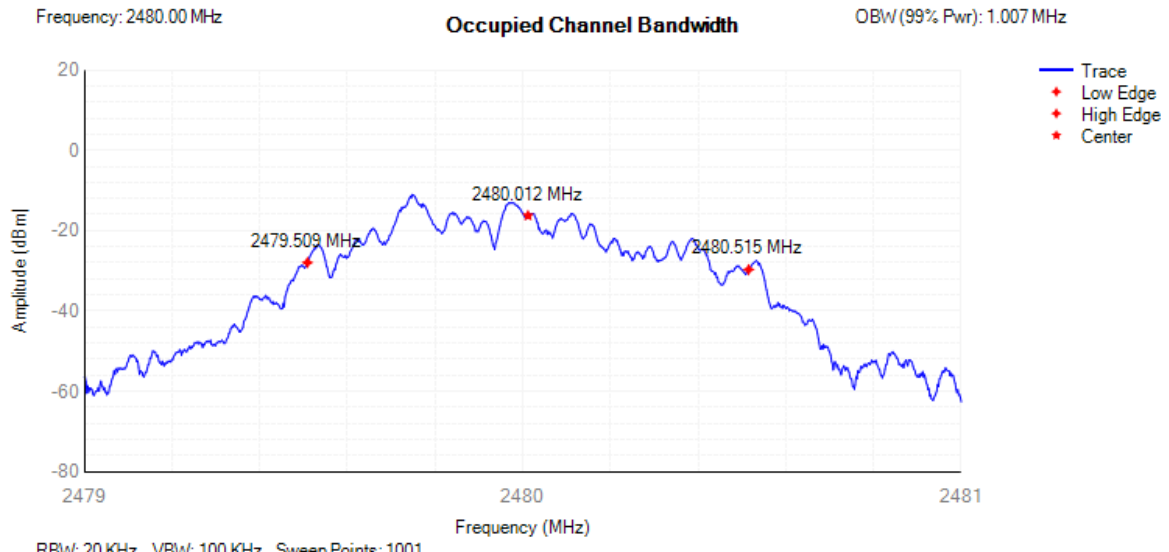

4.1.4 TRANSMITTER UNWANTED EMISSIONS IN THE OUT-OF-BAND DOMAIN

Condition	Mode	Frequency (MHz)	OOB Frequency (MHz)	Level (dBm/MHz)	Limit (dBm/MHz)	Verdict
NVNT	BLE	2402	2399.5	-63.4	-10	Pass
NVNT	BLE	2402	2399.493	-63.37	-10	Pass
NVNT	BLE	2402	2398.493	-62.22	-20	Pass
NVNT	BLE	2402	2398.486	-64.37	-20	Pass
NVNT	BLE	2480	2484	-63.5	-10	Pass
NVNT	BLE	2480	2484.007	-63.8	-10	Pass
NVNT	BLE	2480	2485.007	-62.62	-20	Pass
NVNT	BLE	2480	2485.014	-63.6	-20	Pass

Tx. Emissions OOB NVNT BLE 2402MHz

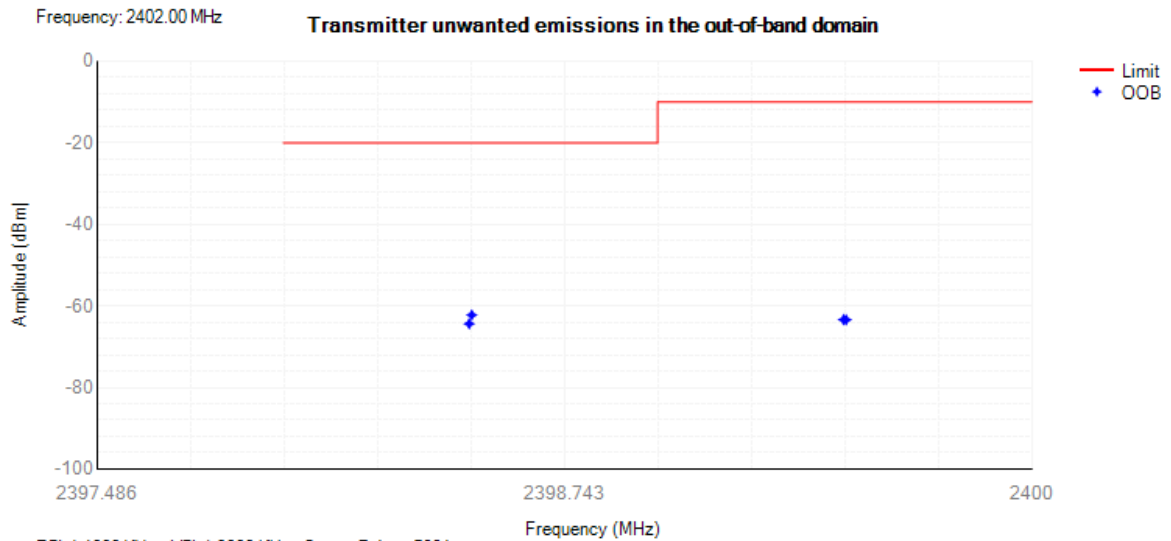

Tx. Emissions OOB NVNT BLE 2480MHz

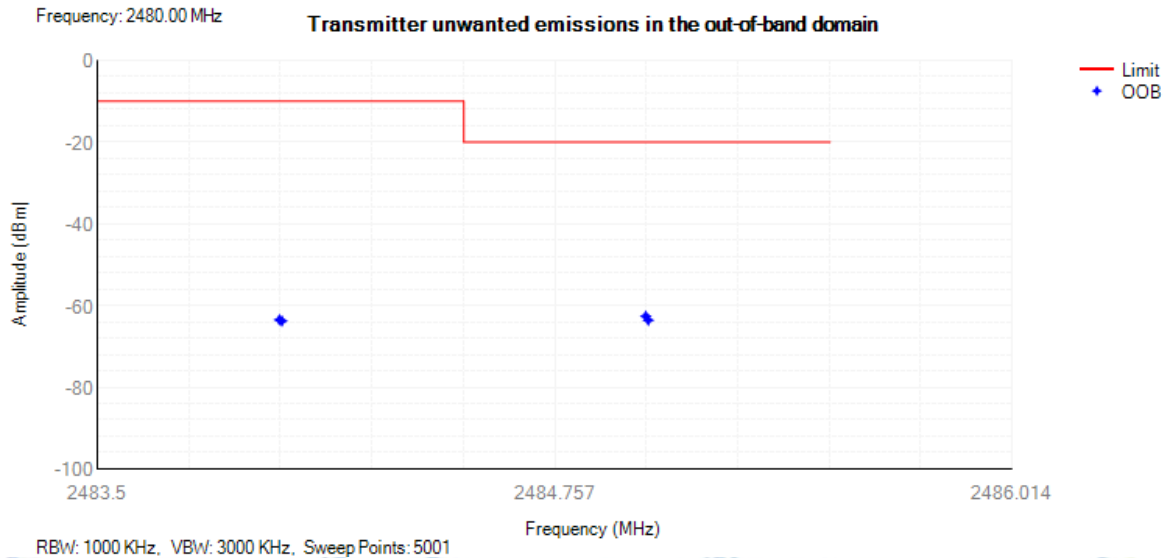

4.1.5 TRANSMITTER UNWANTED EMISSIONS IN THE SPURIOUS DOMAIN

Condition	Mode	Frequency (MHz)	Range	Spur Freq (MHz)	Spur Level Peak(dBm)	Spur Level RMS(dBm)	Limit (dBm)	Verdict
NVNT	BLE	2402	30 MHz -47 MHz	36.8	-67.09	NA	-36	Pass
NVNT	BLE	2402	47 MHz -74 MHz	48.35	-66.95	NA	-54	Pass
NVNT	BLE	2402	74 MHz -87.5 MHz	80.1	-67.13	NA	-36	Pass
NVNT	BLE	2402	87.5 MHz -118 MHz	96.65	-66.37	NA	-54	Pass
NVNT	BLE	2402	118 MHz -174 MHz	140.35	-66.08	NA	-36	Pass
NVNT	BLE	2402	174 MHz -230 MHz	196.3	-65.39	NA	-54	Pass
NVNT	BLE	2402	230 MHz -470 MHz	412.6	-64.88	NA	-36	Pass
NVNT	BLE	2402	470 MHz -694 MHz	491.95	-65.34	NA	-54	Pass
NVNT	BLE	2402	694 MHz -1000 MHz	990.35	-64.25	NA	-36	Pass
NVNT	BLE	2402	1000 MHz -2398 MHz	2397.5	-46.54	NA	-30	Pass
NVNT	BLE	2402	2485.5 MHz -12750 MHz	6976.5	-44.85	NA	-30	Pass
NVNT	BLE	2440	30 MHz -47 MHz	32.25	-66.74	NA	-36	Pass
NVNT	BLE	2440	47 MHz -74 MHz	53.75	-66.29	NA	-54	Pass
NVNT	BLE	2440	74 MHz -87.5 MHz	85.75	-66.77	NA	-36	Pass
NVNT	BLE	2440	87.5 MHz -118 MHz	89.75	-66.03	NA	-54	Pass
NVNT	BLE	2440	118 MHz -174 MHz	164.4	-66.02	NA	-36	Pass
NVNT	BLE	2440	174 MHz -230 MHz	182.9	-65.69	NA	-54	Pass
NVNT	BLE	2440	230 MHz -470 MHz	337.15	-65.09	NA	-36	Pass
NVNT	BLE	2440	470 MHz -694 MHz	624	-65.3	NA	-54	Pass
NVNT	BLE	2440	694 MHz -1000 MHz	886.35	-64.11	NA	-36	Pass
NVNT	BLE	2440	1000 MHz -2398 MHz	1645.5	-53.02	NA	-30	Pass
NVNT	BLE	2440	2485.5 MHz -12750 MHz	6586.5	-45.55	NA	-30	Pass
NVNT	BLE	2480	30 MHz -47 MHz	40.35	-67.21	NA	-36	Pass
NVNT	BLE	2480	47 MHz -74 MHz	60.25	-66.28	NA	-54	Pass
NVNT	BLE	2480	74 MHz -87.5 MHz	84.2	-66.93	NA	-36	Pass
NVNT	BLE	2480	87.5 MHz -118 MHz	89.85	-66.22	NA	-54	Pass
NVNT	BLE	2480	118 MHz -174 MHz	169.65	-66.39	NA	-36	Pass
NVNT	BLE	2480	174 MHz -230 MHz	203.85	-66.19	NA	-54	Pass
NVNT	BLE	2480	230 MHz -470 MHz	399.85	-65.45	NA	-36	Pass
NVNT	BLE	2480	470 MHz -694 MHz	555.85	-64.76	NA	-54	Pass
NVNT	BLE	2480	694 MHz -1000 MHz	909.4	-63.95	NA	-36	Pass
NVNT	BLE	2480	1000 MHz -2398 MHz	2234.5	-53.31	NA	-30	Pass
NVNT	BLE	2480	2485.5 MHz -12750 MHz	6934.5	-45.24	NA	-30	Pass

Tx. Spurious NVNT BLE 2402MHz

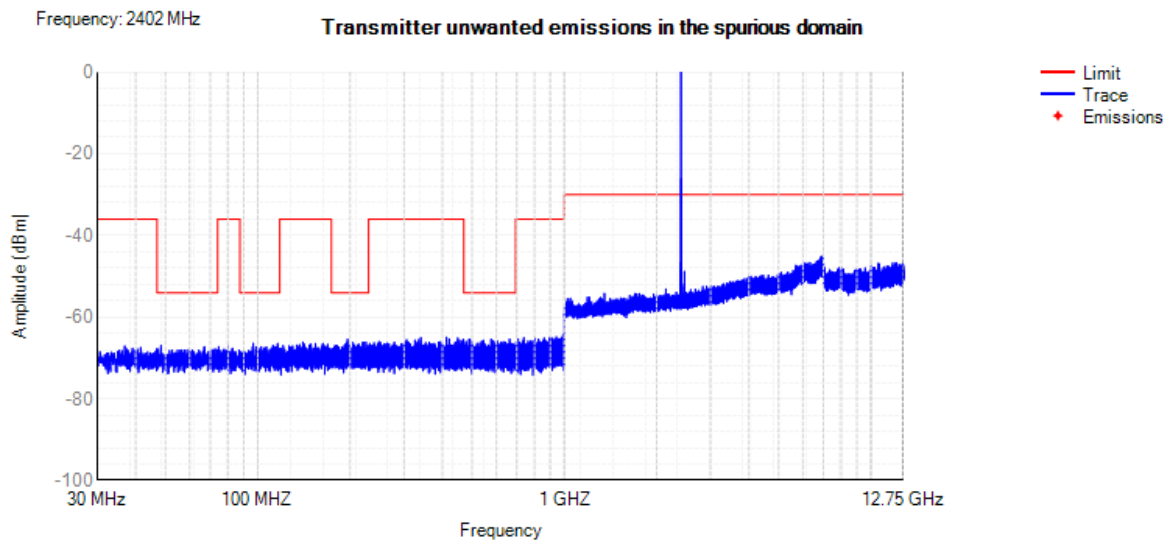

Tx. Spurious NVNT BLE 2440MHz

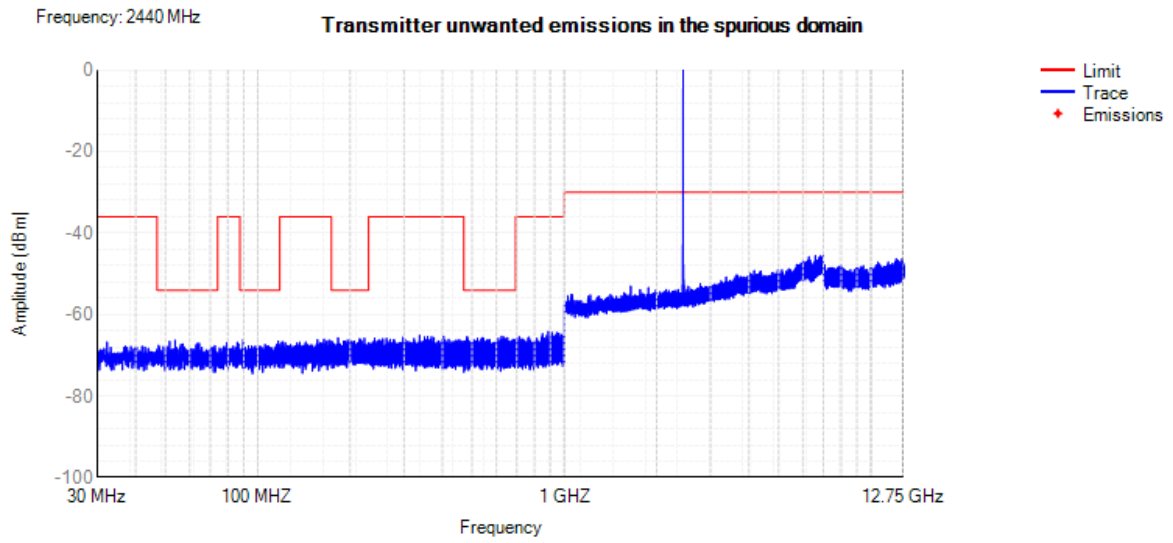

Tx. Spurious NVNT BLE 2480MHz

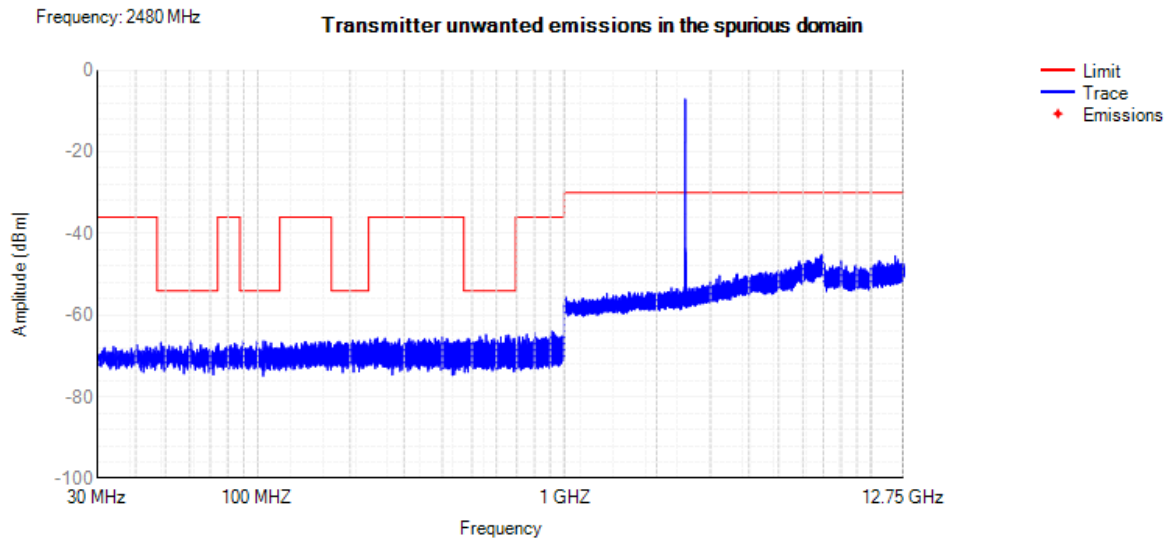

4.1.6 RECEIVER SPURIOUS EMISSIONS

Condition	Mode	Frequency (MHz)	Range	Spur Freq (MHz)	Spur Level Peak(dBm)	Spur Level RMS(dBm)	Limit (dBm)	Verdict
NVNT	BLE	2402	30 MHz -1000 MHz	987.39	-74.04	NA	-57	Pass
NVNT	BLE	2402	1000 MHz -12750 MHz	6744.5	-55.35	NA	-47	Pass
NVNT	BLE	2440	30 MHz -1000 MHz	934.45	-74.79	NA	-57	Pass
NVNT	BLE	2440	1000 MHz -12750 MHz	6910	-54.71	NA	-47	Pass
NVNT	BLE	2480	30 MHz -1000 MHz	581.3	-74.56	NA	-57	Pass
NVNT	BLE	2480	1000 MHz -12750 MHz	6983	-54.6	NA	-47	Pass

Rx. Spurious NVNT BLE 2402MHz

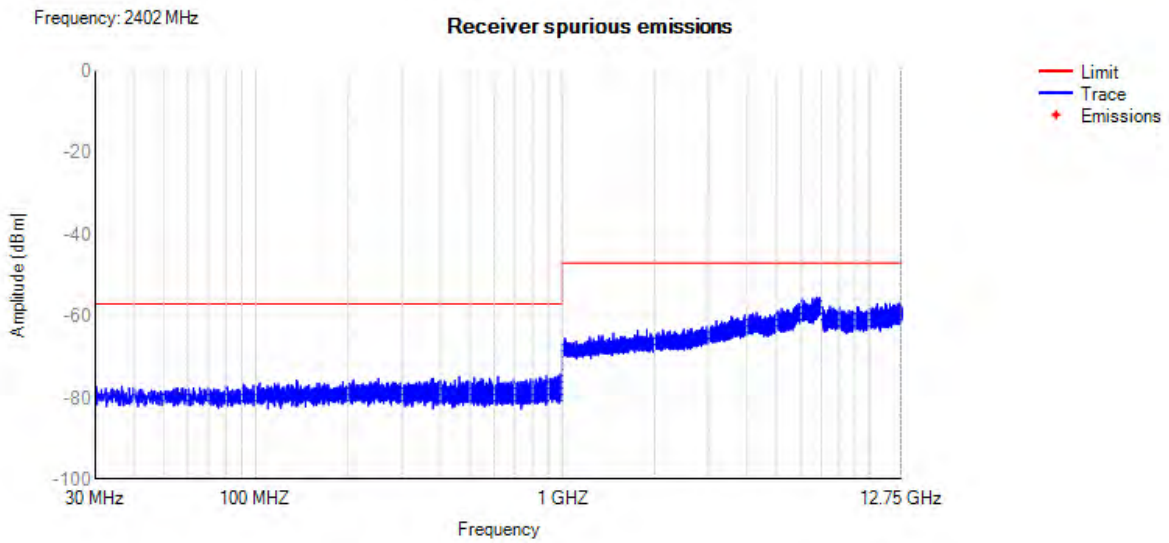

Rx. Spurious NVNT BLE 2440MHz

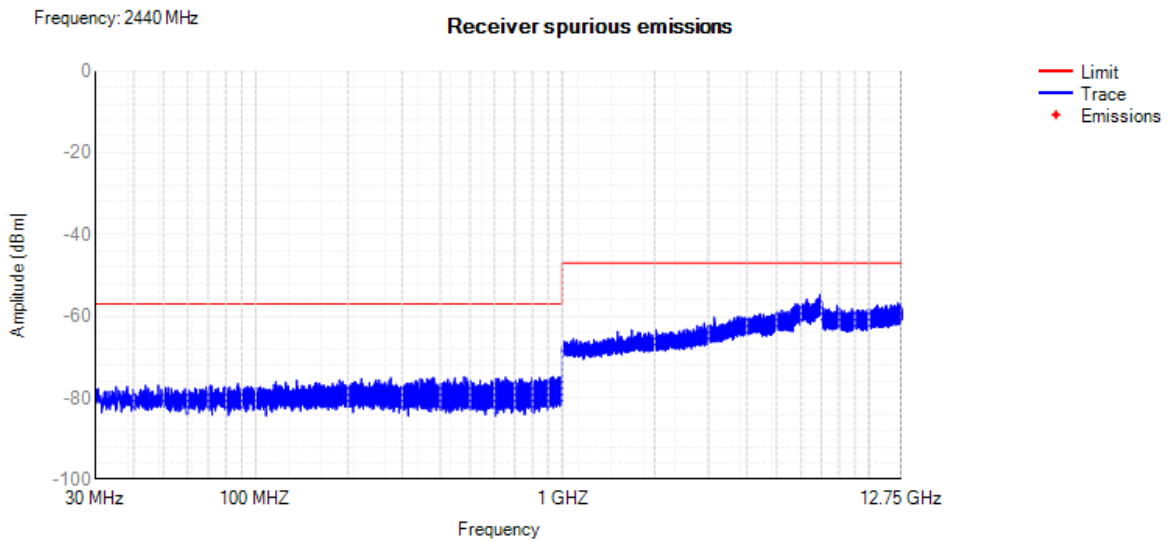

Rx. Spurious NVNT BLE 2480MHz

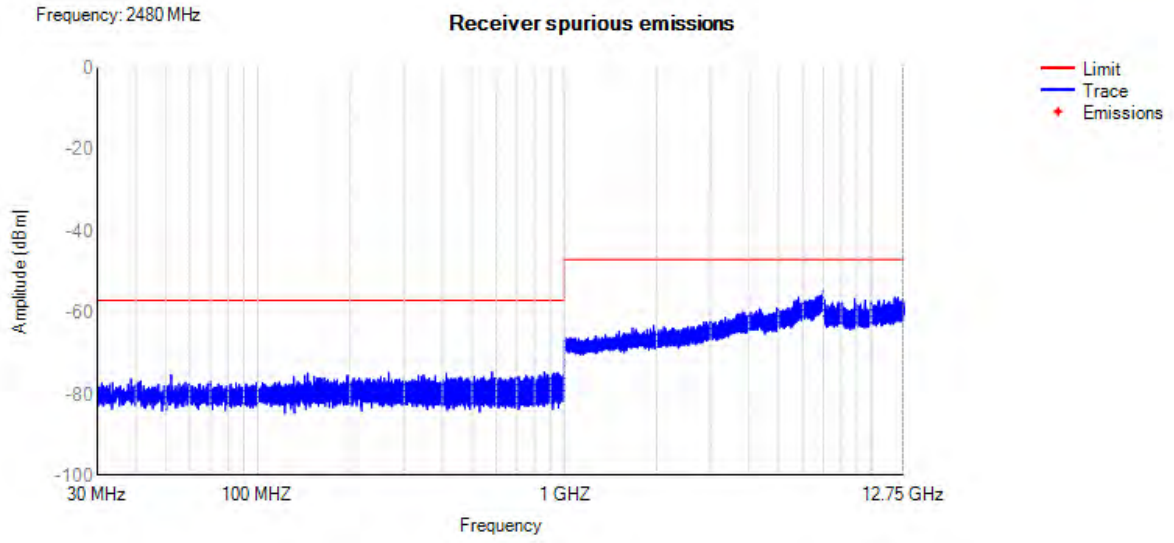

2M:

4.2.1 RF OUTPUT POWER

Condition	Mode	Frequency (MHz)	Max Burst RMS Power (dBm)	Burst Number	Max EIRP (dBm)	Limit (dBm)	Verdict
NVNT	BLE	2402	1.47	160	2.27	20	Pass
NVNT	BLE	2440	2.55	160	3.35	20	Pass
NVNT	BLE	2480	2.56	160	3.36	20	Pass
NVLT	BLE	2402	0.62	160	1.42	20	Pass
NVLT	BLE	2440	1.77	160	2.57	20	Pass
NVLT	BLE	2480	2.02	160	2.82	20	Pass
NVHT	BLE	2402	0.56	160	1.36	20	Pass
NVHT	BLE	2440	1.87	160	2.67	20	Pass
NVHT	BLE	2480	2.22	160	3.02	20	Pass

Power NVNT BLE 2402MHz

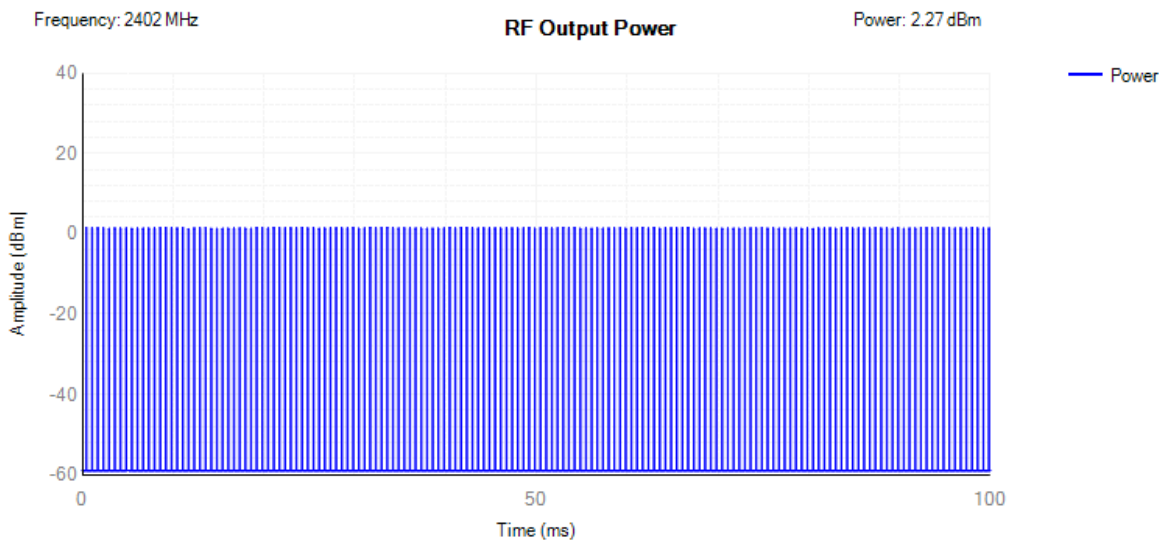

Power NVNT BLE 2440MHz

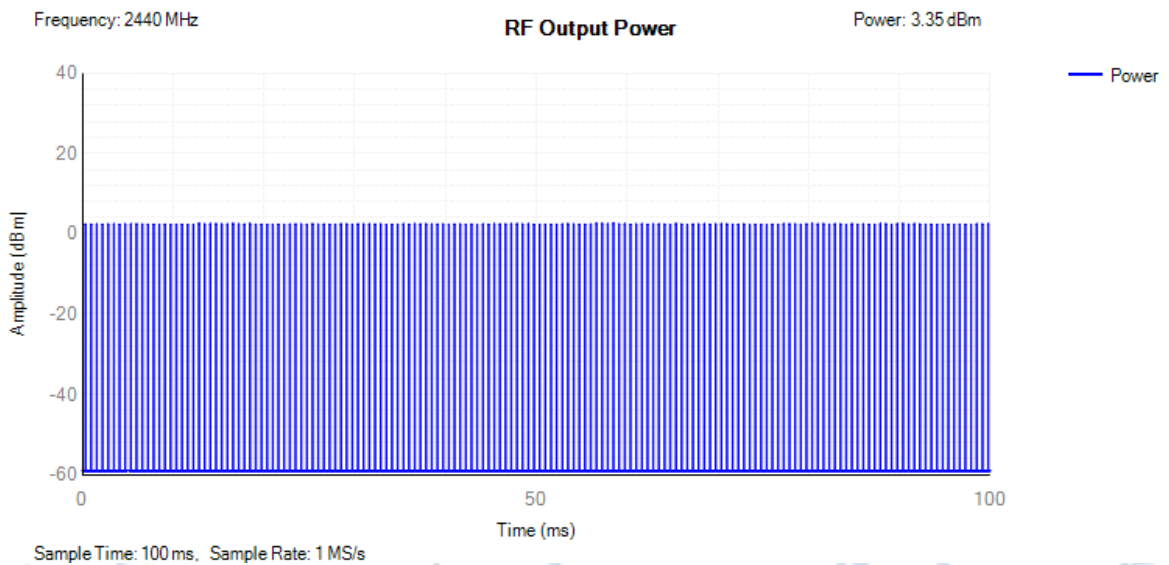

Power NVNT BLE 2480MHz

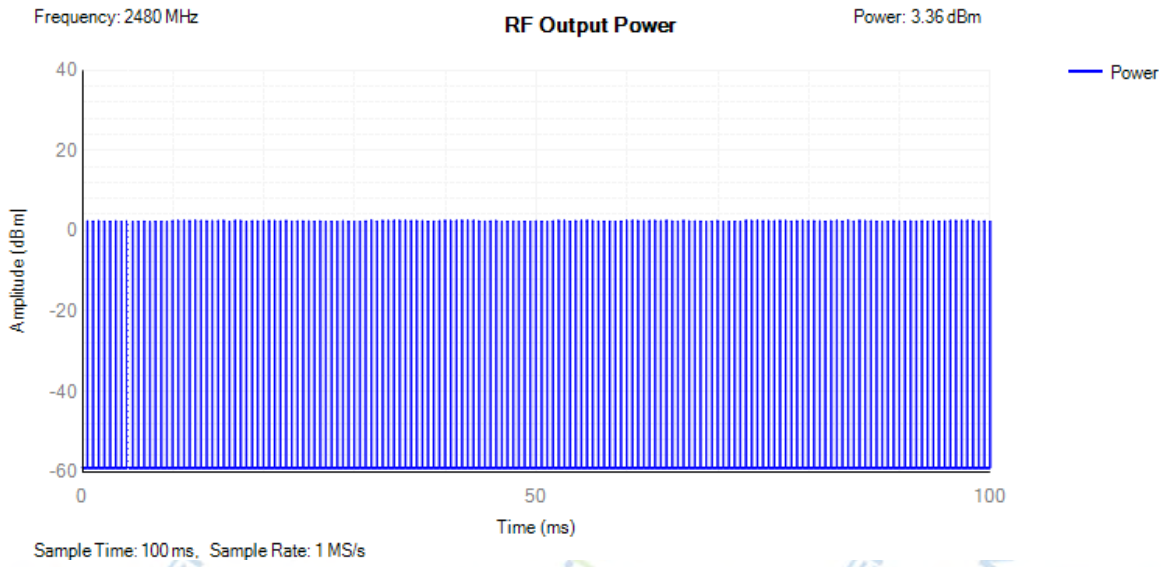

4.2.2 POWER SPECTRAL DENSITY

Condition	Mode	Frequency (MHz)	Max PSD (dBm/MHz)	Limit (dBm/MHz)	Verdict
NVNT	BLE	2402	1.62	10	Pass
NVNT	BLE	2440	2.71	10	Pass
NVNT	BLE	2480	2.74	10	Pass

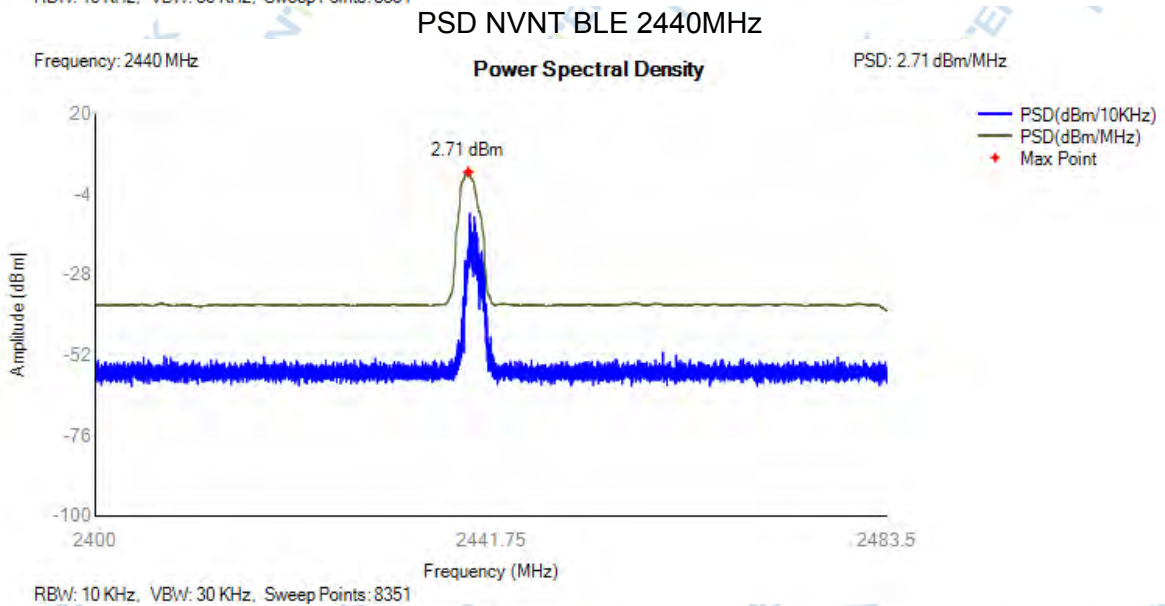
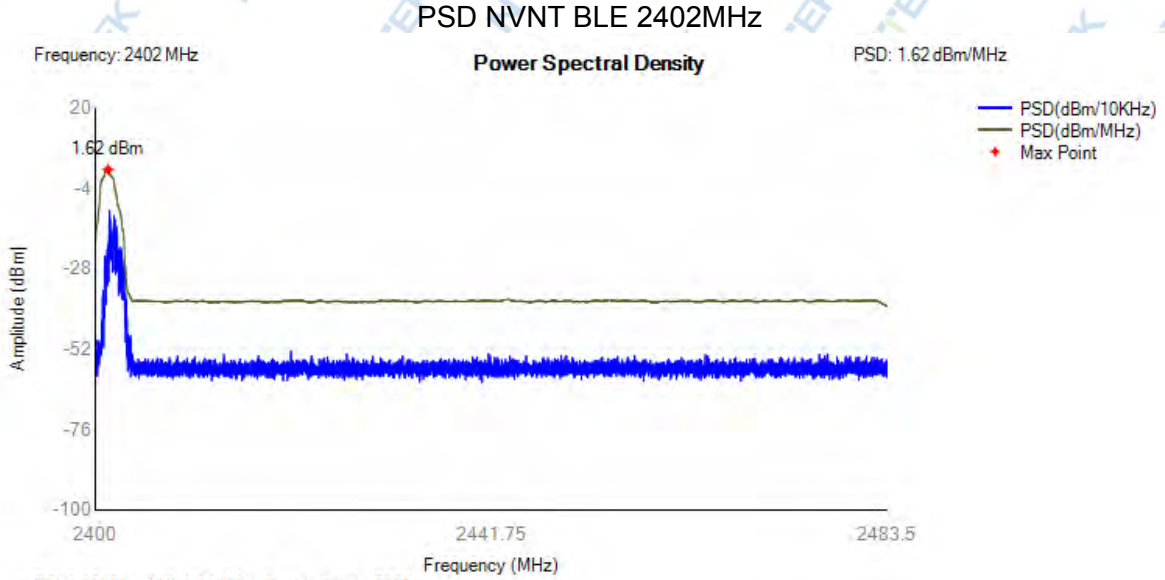

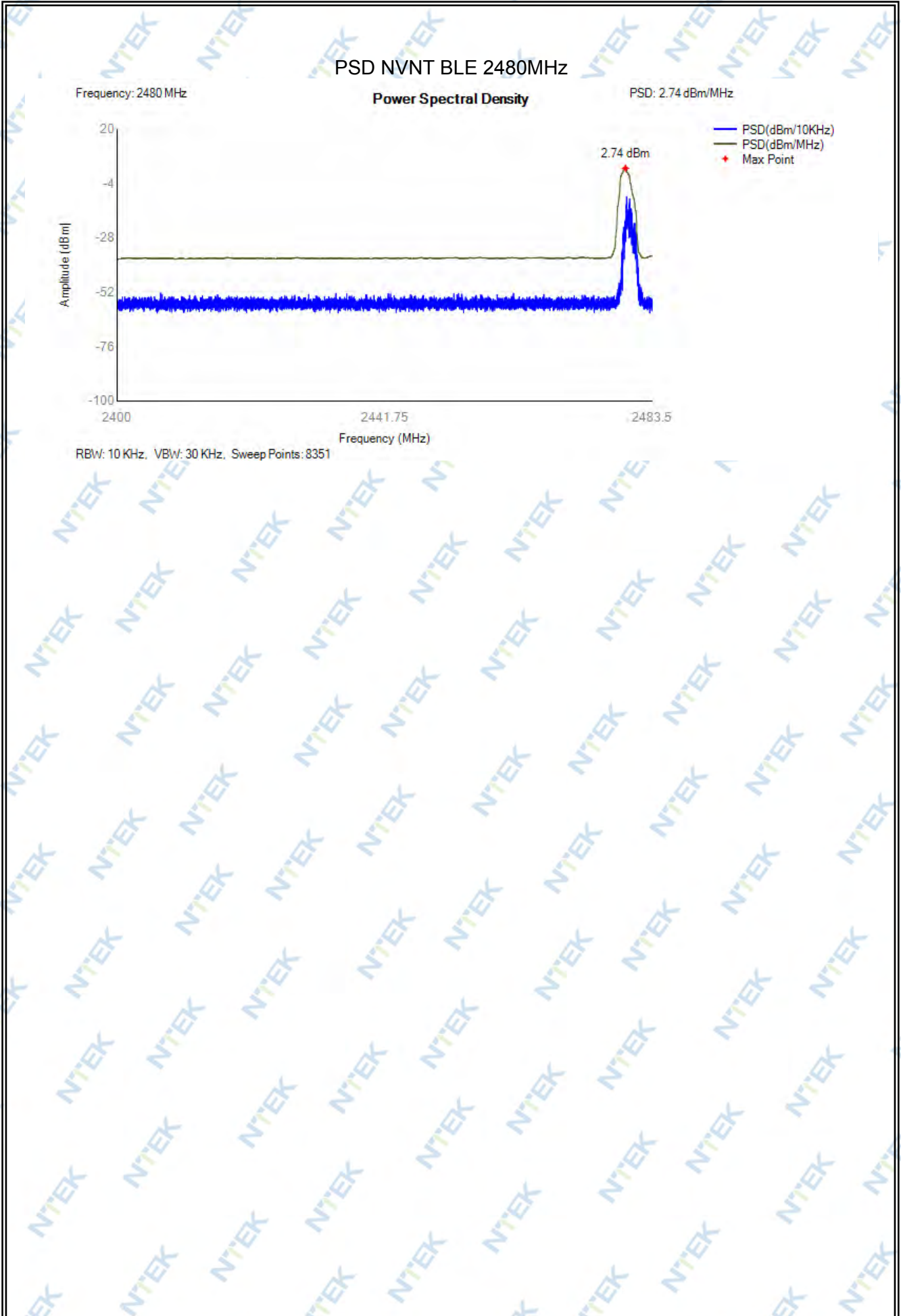

4.2.3 OCCUPIED CHANNEL BANDWIDTH

Condition	Mode	Frequency (MHz)	Center Frequency (MHz)	OBW (MHz)	Lower Edge (MHz)	Upper Edge (MHz)	Limit OBW (MHz)	Verdict
NVNT	BLE	2402	2402.016	2.03	2401.001	2403.031	2400 - 2483.5MHz	Pass
NVNT	BLE	2440	2440.014	2.034	2438.997	2441.031	2400 - 2483.5MHz	Pass
NVNT	BLE	2480	2480.008	2.03	2478.993	2481.023	2400 - 2483.5MHz	Pass

OBW NVNT BLE 2402MHz

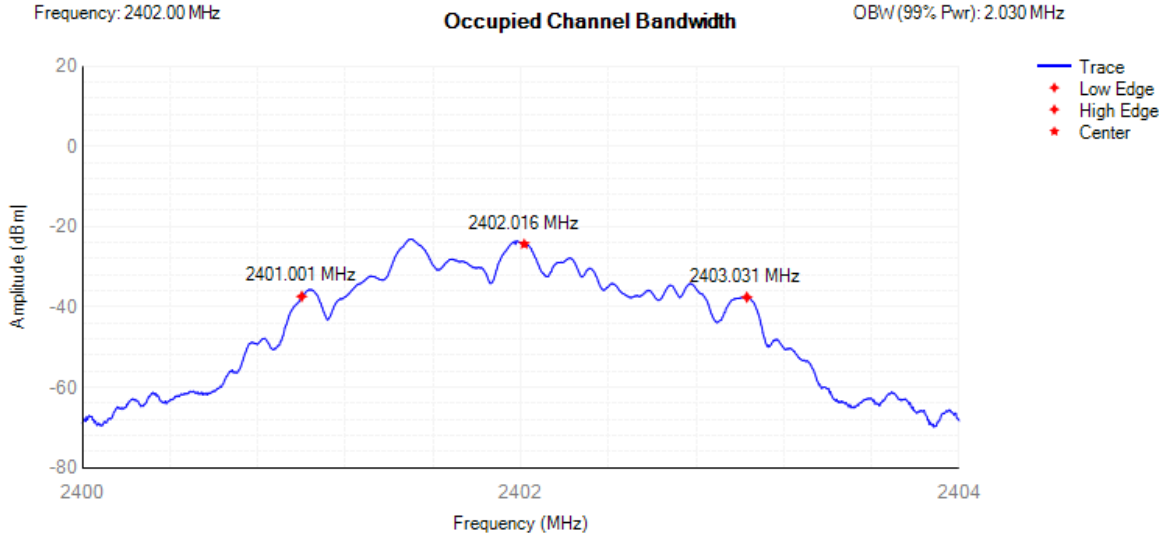

OBW NVNT BLE 2440MHz

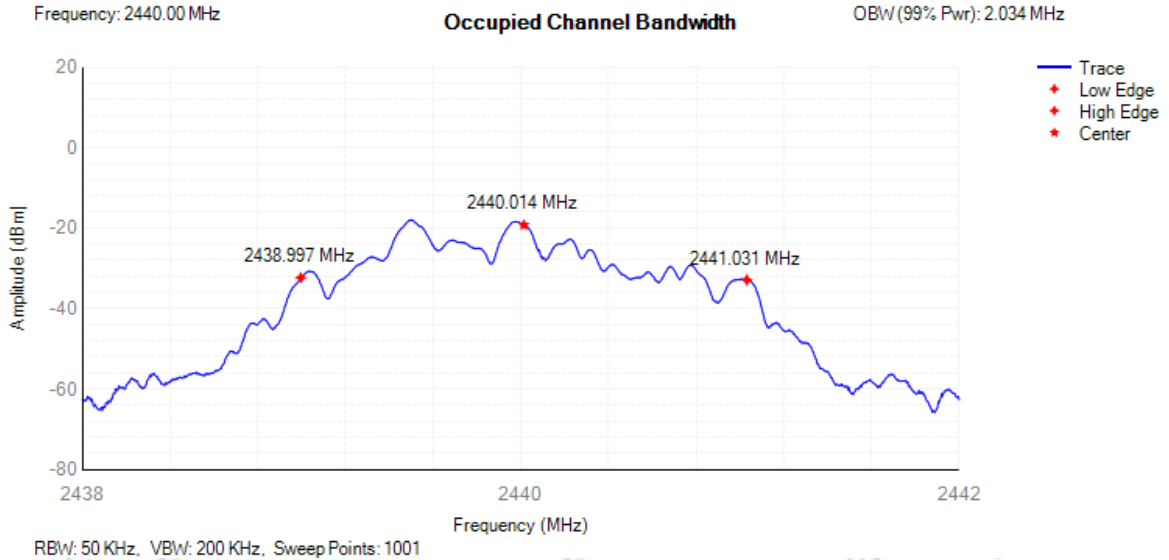

OBW NVNT BLE 2480MHz

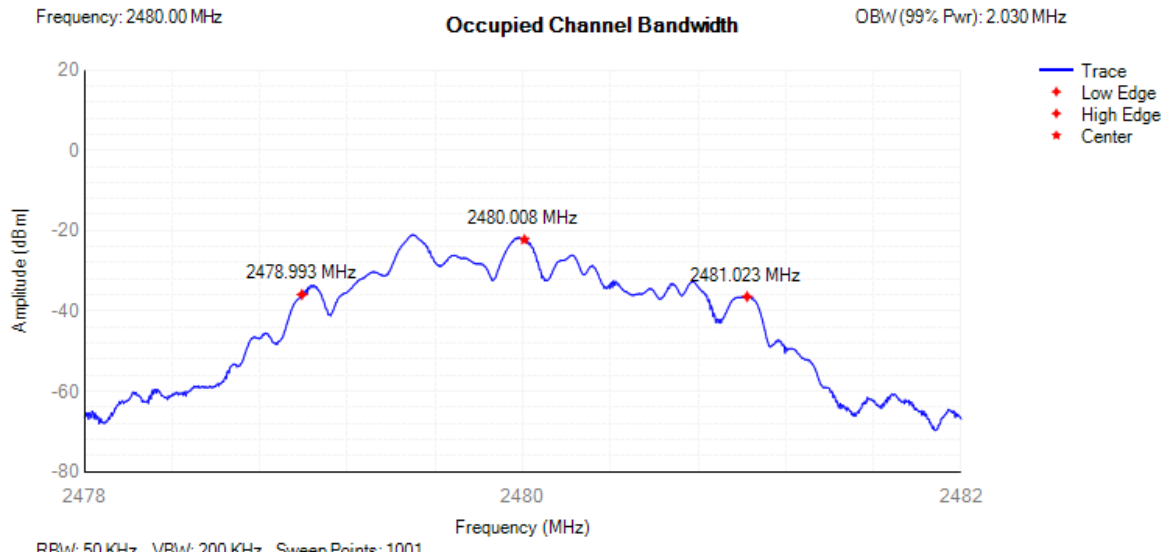

4.2.4 TRANSMITTER UNWANTED EMISSIONS IN THE OUT-OF-BAND DOMAIN

Condition	Mode	Frequency (MHz)	OOB Frequency (MHz)	Level (dBm/MHz)	Limit (dBm/MHz)	Verdict
NVNT	BLE	2402	2399.5	-62.51	-10	Pass
NVNT	BLE	2402	2398.5	-62.84	-10	Pass
NVNT	BLE	2402	2398.47	-61.28	-10	Pass
NVNT	BLE	2402	2397.47	-60.06	-20	Pass
NVNT	BLE	2402	2396.47	-63.77	-20	Pass
NVNT	BLE	2402	2396.44	-60.24	-20	Pass
NVNT	BLE	2480	2484	-63.15	-10	Pass
NVNT	BLE	2480	2485	-63.25	-10	Pass
NVNT	BLE	2480	2485.03	-60.12	-10	Pass
NVNT	BLE	2480	2486.03	-62.53	-20	Pass
NVNT	BLE	2480	2487.03	-63.45	-20	Pass
NVNT	BLE	2480	2487.06	-63.28	-20	Pass

Tx. Emissions OOB NVNT BLE 2402MHz

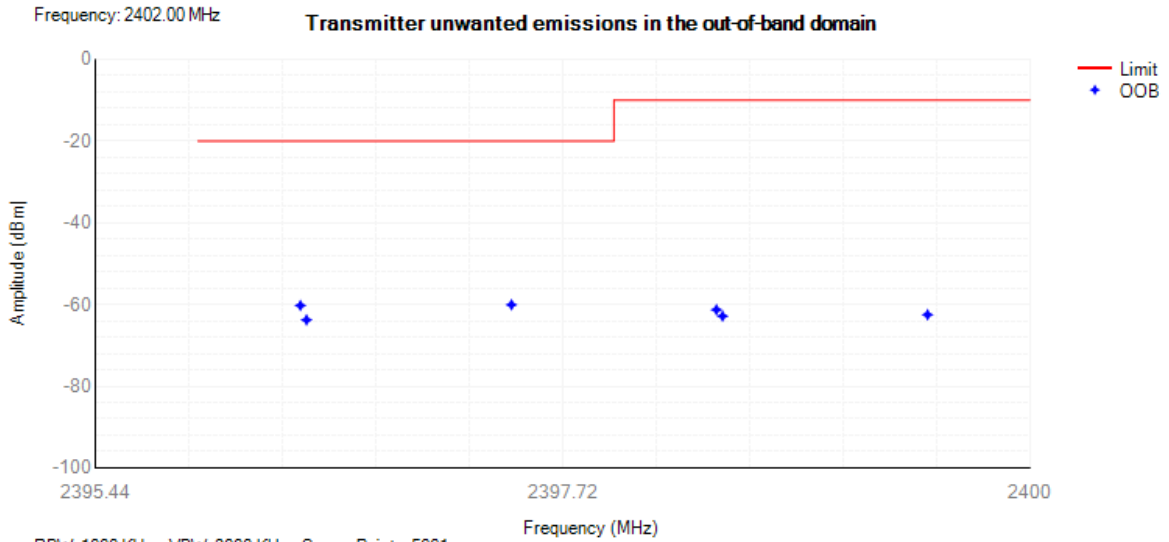

Tx. Emissions OOB NVNT BLE 2480MHz

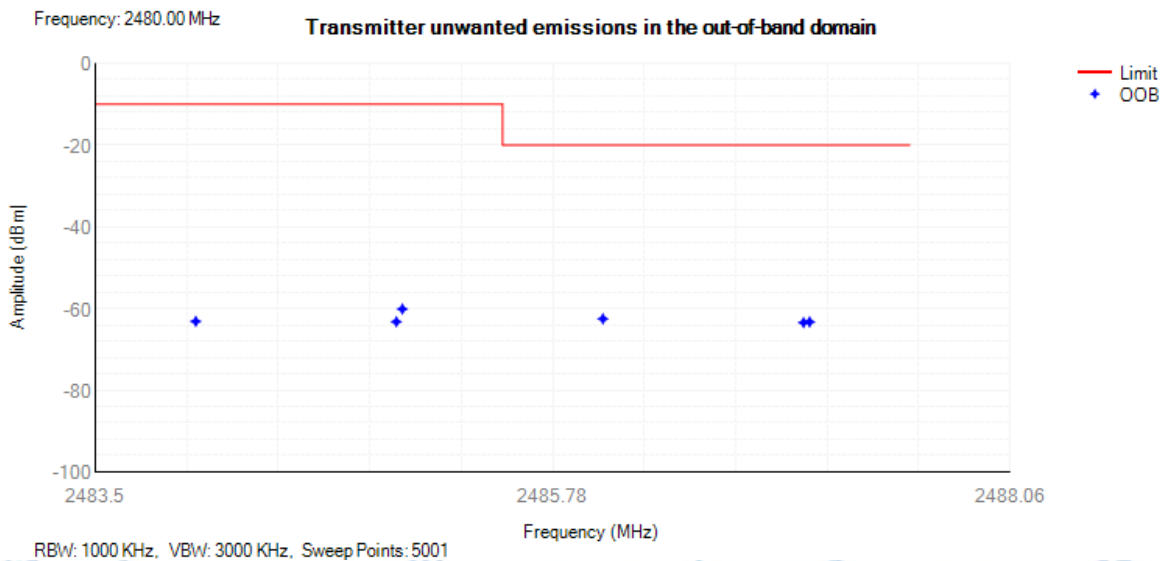

4.2.5 TRANSMITTER UNWANTED EMISSIONS IN THE SPURIOUS DOMAIN

Condition	Mode	Frequency (MHz)	Range	Spur Freq (MHz)	Spur Level Peak(dBm)	Spur Level RMS(dBm)	Limit (dBm)	Verdict
NVNT	BLE	2402	30 MHz -47 MHz	35.2	-66.78	NA	-36	Pass
NVNT	BLE	2402	47 MHz -74 MHz	61.5	-66.64	NA	-54	Pass
NVNT	BLE	2402	74 MHz -87.5 MHz	74.75	-67.17	NA	-36	Pass
NVNT	BLE	2402	87.5 MHz -118 MHz	106.2	-66.12	NA	-54	Pass
NVNT	BLE	2402	118 MHz -174 MHz	154.6	-65.77	NA	-36	Pass
NVNT	BLE	2402	174 MHz -230 MHz	222.55	-64.39	NA	-54	Pass
NVNT	BLE	2402	230 MHz -470 MHz	368.05	-64.82	NA	-36	Pass
NVNT	BLE	2402	470 MHz -694 MHz	547.05	-64.92	NA	-54	Pass
NVNT	BLE	2402	694 MHz -1000 MHz	982.6	-64.03	NA	-36	Pass
NVNT	BLE	2402	1000 MHz -2396 MHz	2395.5	-50.99	NA	-30	Pass
NVNT	BLE	2402	2487.5 MHz -12750 MHz	6882	-45.21	NA	-30	Pass
NVNT	BLE	2440	30 MHz -47 MHz	38.75	-66.84	NA	-36	Pass
NVNT	BLE	2440	47 MHz -74 MHz	51.35	-66.83	NA	-54	Pass
NVNT	BLE	2440	74 MHz -87.5 MHz	81.4	-65.93	NA	-36	Pass
NVNT	BLE	2440	87.5 MHz -118 MHz	89.1	-65.5	NA	-54	Pass
NVNT	BLE	2440	118 MHz -174 MHz	173.65	-65.69	NA	-36	Pass
NVNT	BLE	2440	174 MHz -230 MHz	201.85	-65.62	NA	-54	Pass
NVNT	BLE	2440	230 MHz -470 MHz	328.95	-64.32	NA	-36	Pass
NVNT	BLE	2440	470 MHz -694 MHz	658.95	-64.75	NA	-54	Pass
NVNT	BLE	2440	694 MHz -1000 MHz	917.85	-64.37	NA	-36	Pass
NVNT	BLE	2440	1000 MHz -2396 MHz	1787	-53.07	NA	-30	Pass
NVNT	BLE	2440	2487.5 MHz -12750 MHz	6829	-45.32	NA	-30	Pass
NVNT	BLE	2480	30 MHz -47 MHz	32.25	-65.88	NA	-36	Pass
NVNT	BLE	2480	47 MHz -74 MHz	51	-66.44	NA	-54	Pass
NVNT	BLE	2480	74 MHz -87.5 MHz	85.75	-66.69	NA	-36	Pass
NVNT	BLE	2480	87.5 MHz -118 MHz	89.05	-65.05	NA	-54	Pass
NVNT	BLE	2480	118 MHz -174 MHz	157.8	-65.91	NA	-36	Pass
NVNT	BLE	2480	174 MHz -230 MHz	229.55	-65.13	NA	-54	Pass
NVNT	BLE	2480	230 MHz -470 MHz	433.15	-64.33	NA	-36	Pass
NVNT	BLE	2480	470 MHz -694 MHz	583.45	-64.48	NA	-54	Pass
NVNT	BLE	2480	694 MHz -1000 MHz	989.45	-64.15	NA	-36	Pass
NVNT	BLE	2480	1000 MHz -2396 MHz	1733	-52.12	NA	-30	Pass
NVNT	BLE	2480	2487.5 MHz -12750 MHz	6912.5	-44.37	NA	-30	Pass

Tx. Spurious NVNT BLE 2402MHz

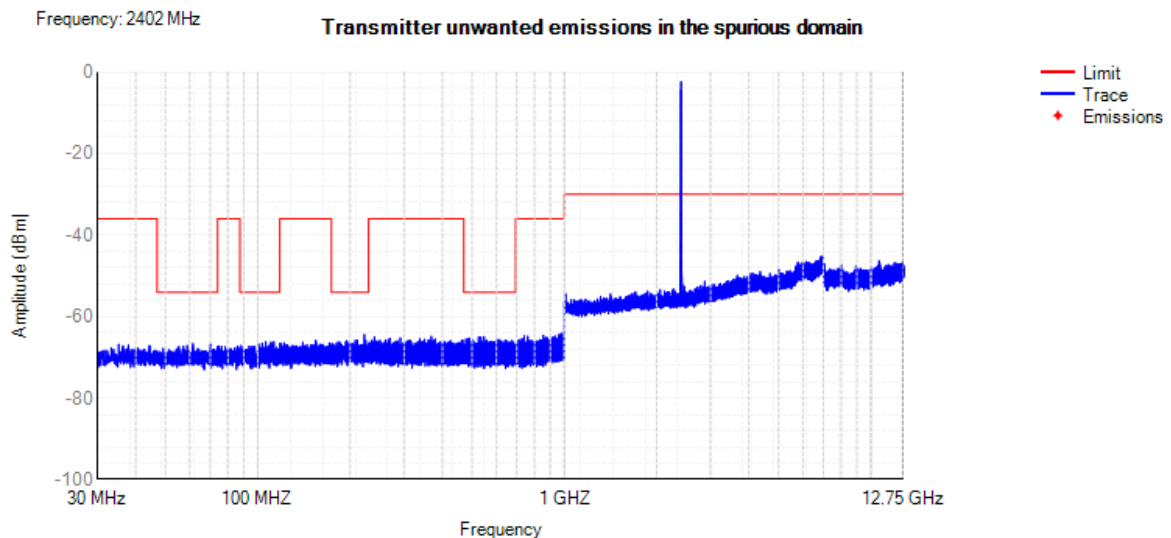

Tx. Spurious NVNT BLE 2440MHz

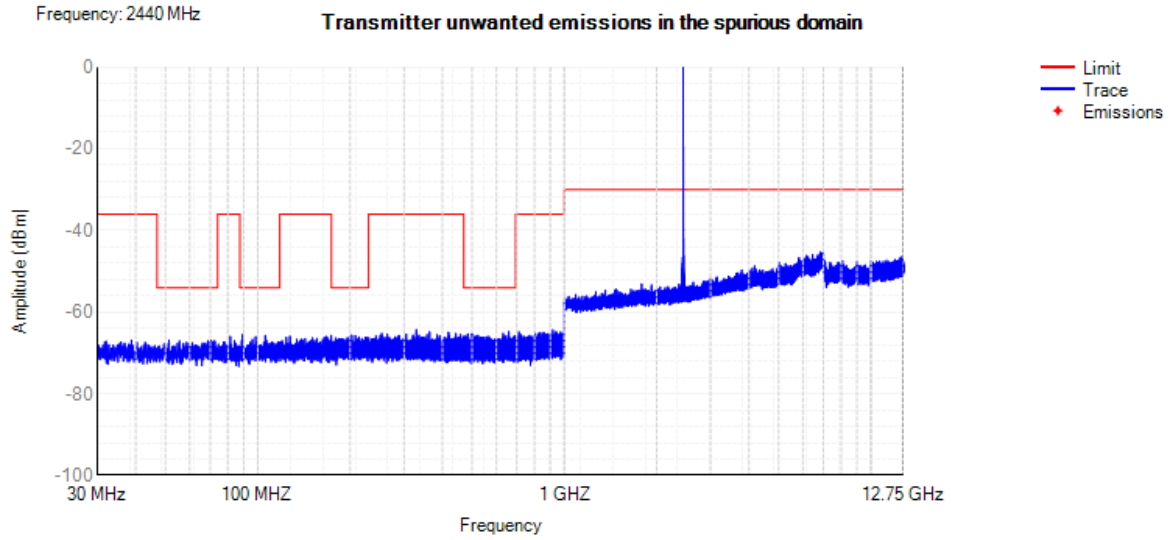

Tx. Spurious NVNT BLE 2480MHz

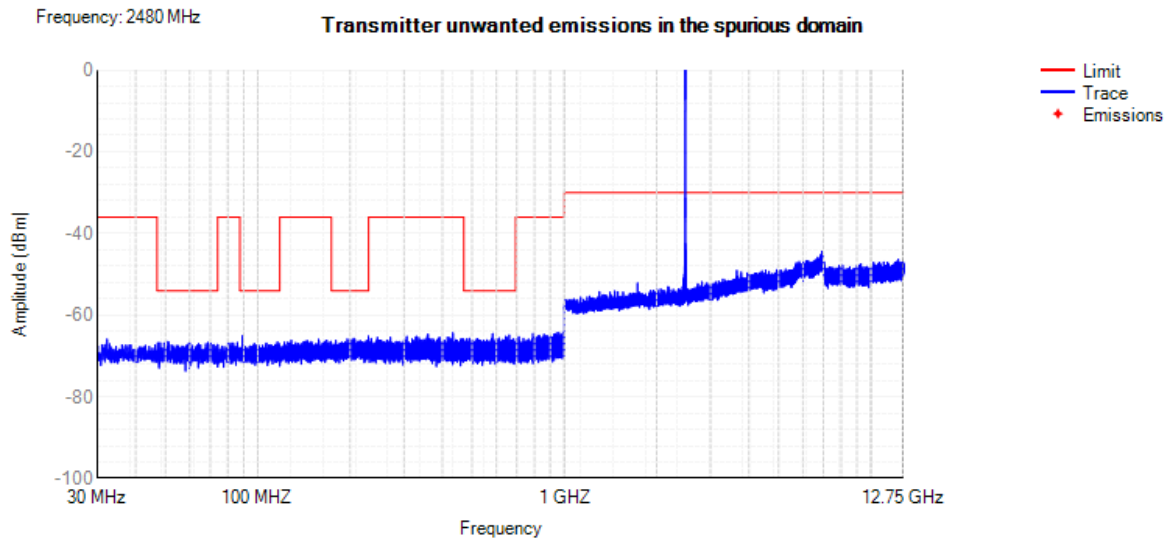

4.2.6 RECEIVER SPURIOUS EMISSIONS

Condition	Mode	Frequency (MHz)	Range	Spur Freq (MHz)	Spur Level Peak(dBm)	Spur Level RMS(dBm)	Limit (dBm)	Verdict
NVNT	BLE	2402	30 MHz -1000 MHz	979.95	-73.85	NA	-57	Pass
NVNT	BLE	2402	1000 MHz -12750 MHz	6905	-54.74	NA	-47	Pass
NVNT	BLE	2440	30 MHz -1000 MHz	950.35	-73.93	NA	-57	Pass
NVNT	BLE	2440	1000 MHz -12750 MHz	6997.5	-55.69	NA	-47	Pass
NVNT	BLE	2480	30 MHz -1000 MHz	917.3	-74.79	NA	-57	Pass
NVNT	BLE	2480	1000 MHz -12750 MHz	6931	-55.91	NA	-47	Pass

Rx. Spurious NVNT BLE 2402MHz

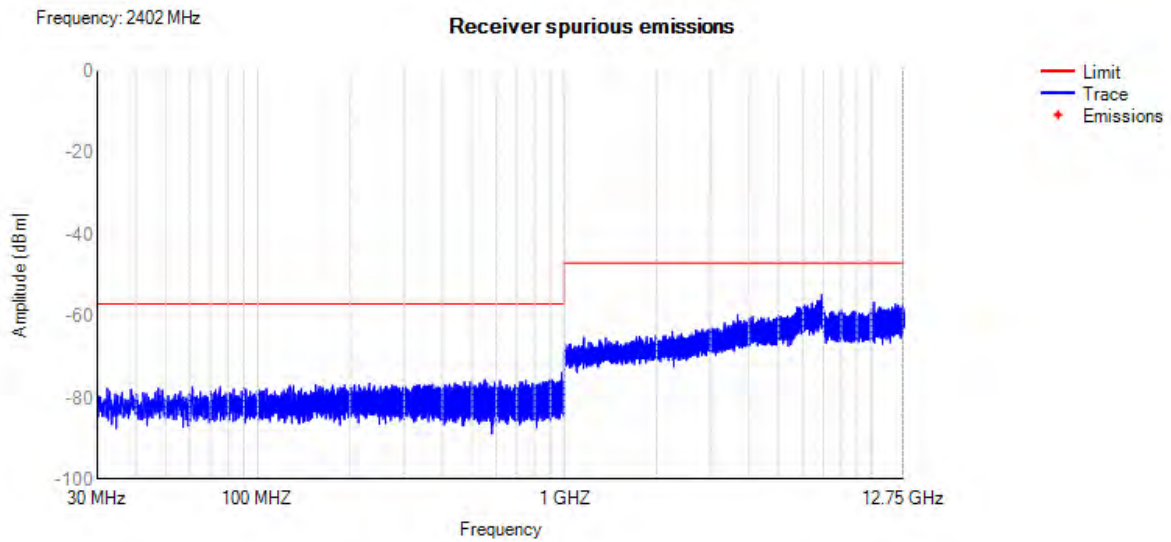

Rx. Spurious NVNT BLE 2440MHz

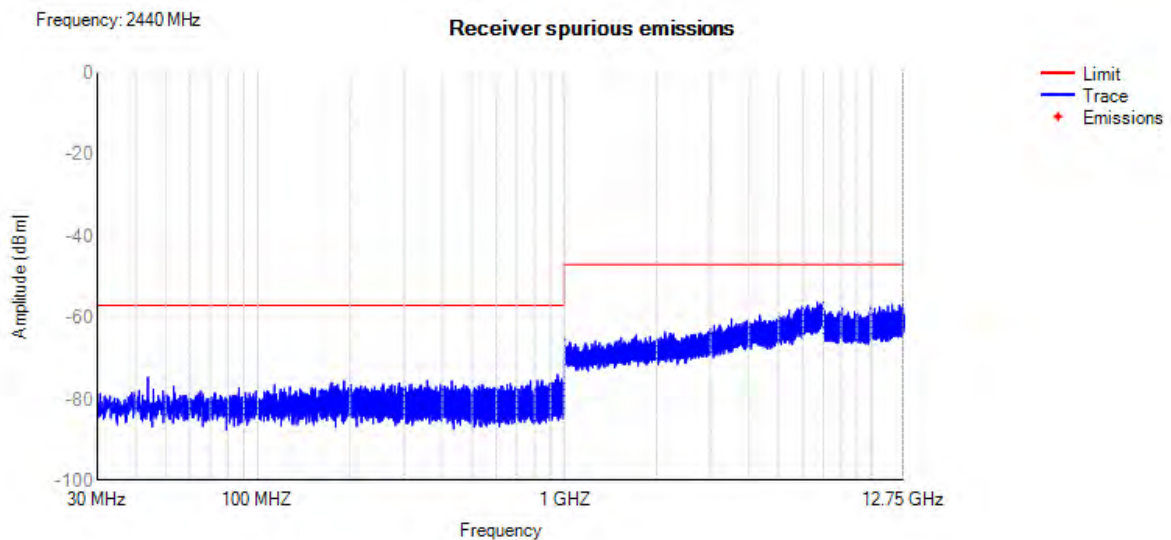

Rx. Spurious NVNT BLE 2480MHz

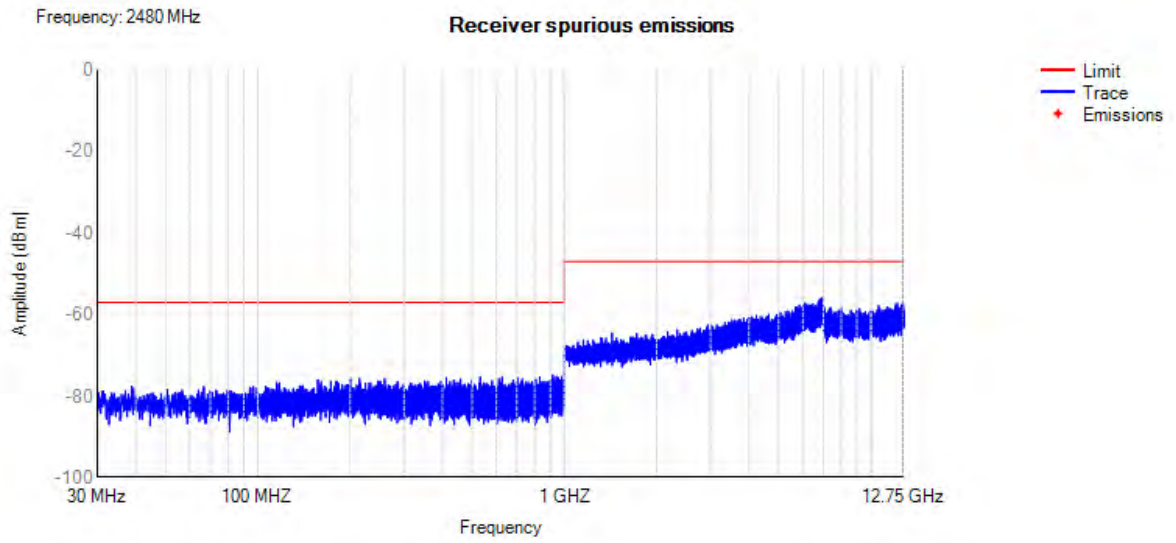

5. EUT TEST PHOTO

SPURIOUS EMISSIONS MEASUREMENT PHOTOS

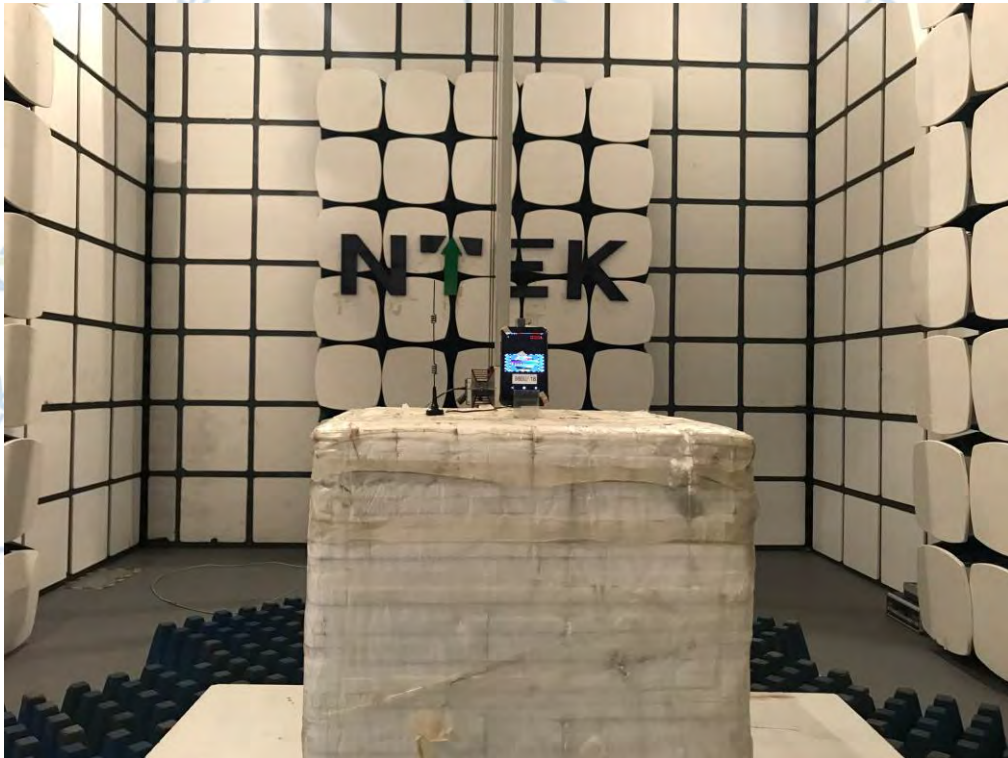
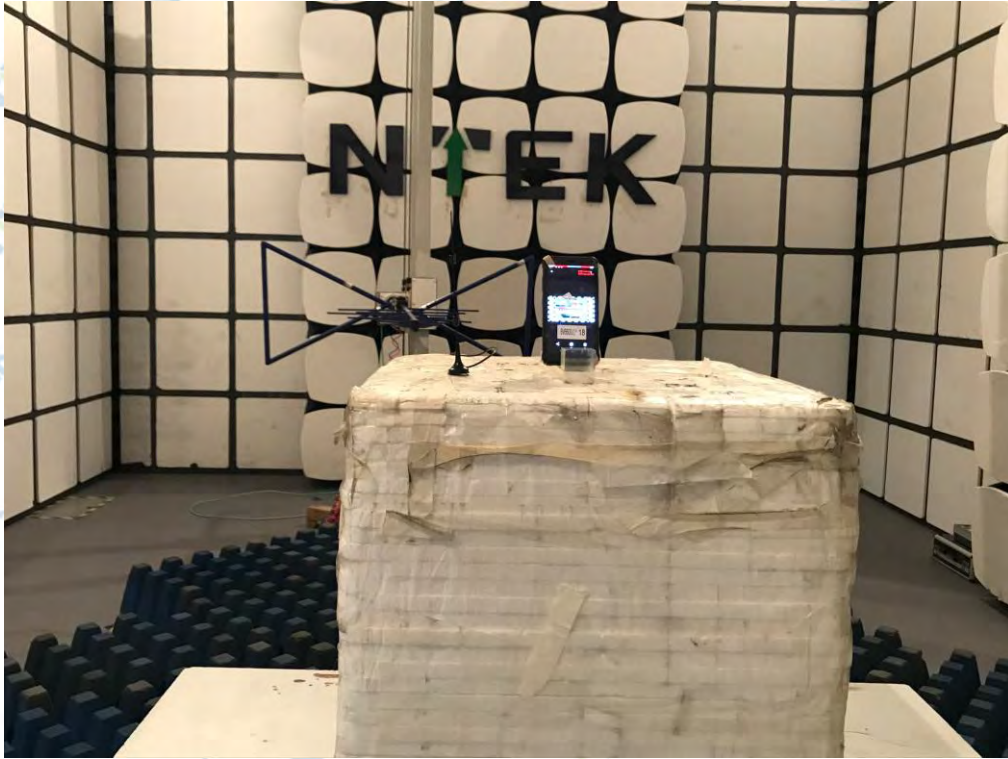

END OF REPORT