



# **RADIO TEST REPORT-WIFI ETSI EN 300 328 V2.2.2 (2019-07)**

**Product :** Smart phone

**Trade Mark :** Blackview

**Model Name :** BV9300

**Family Model :** N/A

**Report No. :** STR230306002003E

## **Prepared for**

**DOKE COMMUNICATION (HK) LIMITED**

**RM 1902 EASEY COMM BLDG 253-261 HENNESSY ROAD WANCHAI HK CHINA**

## **Prepared by**

**Shenzhen NTEK Testing Technology Co., Ltd.**

**1/F, Building E, Fenda Science Park, Sanwei Community, Xixiang Street  
Bao'an District, Shenzhen 518126 P.R. China**

**Tel. 400-800-6106, 0755-2320 0050, 0755-2320 0090**

**Website: <http://www.ntek.org.cn>**

### TEST RESULT CERTIFICATION

**Applicant's name** ..... DOKE COMMUNICATION (HK) LIMITED  
**Address** ..... RM 1902 EASEY COMM BLDG 253-261 HENNESSY ROAD  
 WANCHAI HK CHINA  
**Manufacturer's Name** ..... Shenzhen DOKE Electronic Co.,Ltd  
**Address** ..... 801, Building3, 7th Industrial Zone, Yulv Community, Yutang Road,  
 Guangming District, Shenzhen, China

**Product description**

**Product name**..... Smart phone  
**Trademark** ..... Blackview  
**Model Name** ..... BV9300  
**Family Model** ..... N/A

**Standards** ..... ETSI EN 300 328 V2.2.2 (2019-07)

This device described above has been tested by Shenzhen NTEK, and the test results show that the equipment under test (EUT) is in compliance with the 2014/53/EU RED Directive Art.3.2 requirements. And it is applicable only to the tested sample identified in the report.

This report shall not be reproduced except in full, without the written approval of Shenzhen NTEK, this document may be altered or revised by Shenzhen NTEK, personnel only, and shall be noted in the revision of the document.

**Test Sample Number** ..... T230306001R003

**Date of Test** .....

**Date (s) of performance of tests** ..... Mar 06, 2023 ~ Apr 04, 2023

**Date of Issue** ..... Apr 04, 2023

**Test Result**..... **Pass**

Testing Engineer :   
 \_\_\_\_\_  
 (Mary Hu)

Authorized Signatory :   
 \_\_\_\_\_  
 (Alex Li)

**Table of Contents**

**Page**

|  |           |
|--|-----------|
| <b>1 . GENERAL INFORMATION</b>   | <b>6</b>  |
| 1.1 GENERAL DESCRIPTION OF EUT   | 6         |
| 1.2 INFORMATION ABOUT THE EUT  | 7         |
| 1.3 TEST CONDITIONS AND CHANNEL  | 12        |
| 1.4 DESCRIPTION OF TEST CONDITIONS   | 13        |
| 1.5 DESCRIPTION OF SUPPORT UNITS   | 14        |
| 1.6 EQUIPMENTS LIST FOR ALL TEST ITEMS   | 15        |
| <b>2 . SUMMARY OF TEST RESULTS</b>   | <b>16</b> |
| 2.1 TEST FACILITY  | 17        |
| 2.2 MEASUREMENT UNCERTAINTY  | 17        |
| <b>3 . TEST PROCEDURES AND RESULTLS</b>  | <b>19</b> |
| 3.1 EQUIVALENT ISOTROPIC RADIATED POWER  | 19        |
| 3.1.1 LIMITS OF EQUIVALENT ISOTROPIC RADIATED POWER  | 19        |
| 3.1.2 TEST PROCEDURE   | 19        |
| 3.1.3 TEST SETUP   | 19        |
| 3.1.4 TEST RESULTS   | 20        |
| 3.2 . PEAK POWER DENSITY   | 21        |
| 3.2.1 LIMITS OF POWER SPECTRAL DENSITY   | 21        |
| 3.2.2 TEST PROCEDURE   | 21        |
| 3.2.3 TEST SETUP   | 21        |
| 3.2.4 TEST RESULTS   | 22        |
| 3.3 . OCCUPIED CHANNEL BANDWIDTH   | 23        |
| 3.3.1 LIMITS OF OCCUPIED CHANNEL BANDWIDTH   | 23        |
| 3.3.2 TEST PROCEDURE   | 23        |
| 3.3.3 DEVIATION FROM TEST STANDARD   | 23        |
| 3.3.4 TEST SETUP   | 23        |
| 3.3.5 TEST RESULTS   | 24        |
| 3.4 . TRANSMITTER UNWANTED EMISSIONS IN THE OUT-OF-BAND DOMAIN                             | 25        |
| 3.4.1 LIMITS OF TRANSMITTER UNWANTED EMISSIONS IN THE OUT-OF-BAND DOMAIN                   | 25        |
| 3.4.2 TEST PROCEDURE   | 25        |
| 3.4.3 DEVIATION FROM TEST STANDARD   | 26        |
| 3.4.4 TEST SETUP   | 26        |
| 3.4.5 TEST RESULTS   | 27        |
| 3.5 . ADAPTIVE (CHANNEL ACCESS MECHANISM)  | 28        |
| 3.5.1 APPLICABILITY OF ADAPTIVE REQUIREMENTS AND LILIT FOR WIDE BAND MODULATION TECHNIQUES | 28        |
| 3.5.2 TEST PROCEDURE   | 29        |

**Table of Contents**

**Page**

|   |     |
|---|-----|
| 3.5.3 TEST SETUP CONFIGURATION  | 29  |
| 3.5.4 LIST OF MEASUREMENTS  | 30  |
| 3.5.5 INTERFERENCE THRESHOLD LEVEL                                    | 31  |
| 3.6 . TRANSMITTER UNWANTED EMISSIONS IN THE SPURIOUS DOMAIN           | 32  |
| 3.6.1 LIMITS OF TRANSMITTER UNWANTED EMISSIONS IN THE SPURIOUS DOMAIN | 32  |
| 3.6.2 TEST PROCEDURE  | 32  |
| 3.6.3 DEVIATION FROM TEST STANDARD                                    | 32  |
| 3.6.4 TEST SETUP  | 33  |
| 3.6.5 TEST RESULTS (Radiated measurement)                             | 34  |
| 3.6.6 TEST RESULTS (Conducted measurement)                            | 35  |
| 3.7 . RECEIVER SPURIOUS RADIATION                                     | 36  |
| 3.7.1 LIMITS OF RECEIVER SPURIOUS RADIATION                           | 36  |
| 3.7.2 TEST PROCEDURE  | 36  |
| 3.7.3 DEVIATION FROM TEST STANDARD                                    | 36  |
| 3.7.4 TEST SETUP  | 37  |
| 3.7.5 TEST RESULTS (Radiated measurement)                             | 38  |
| 3.7.6 TEST RESULTS (Conducted measurement)                            | 39  |
| 3.8 . RECEIVER BLOCKING   | 40  |
| 3.8.1 PERFORMANCE CRITERIA  | 40  |
| 3.8.2 LIMITS OF RECEIVER BLOCKING                                     | 40  |
| 3.8.3 TEST PROCEDURE  | 41  |
| 3.8.4 DEVIATION FROM TEST STANDARD                                    | 42  |
| 3.8.5 TEST SETUP  | 42  |
| 3.8.6 TEST RESULTS  | 43  |
| 4 . TEST RESULTS  | 47  |
| 4.1 RF Output Power   | 47  |
| 4.2 Power Spectral Density  | 54  |
| 4.3 Occupied Channel Bandwidth  | 61  |
| 4.4 Transmitter unwanted emissions in the out-of-band domain          | 68  |
| 4.5 Transmitter unwanted emissions in the spurious domain             | 78  |
| 4.6 Receiver spurious emissions                                       | 86  |
| 4.7 Adaptivity  | 93  |
| 4.8 Adaptivity COT Channel Occupancy Time                             | 101 |
| 5 . EUT TEST PHOTO  | 109 |
| SPURIOUS EMISSIONS MEASUREMENT PHOTOS                                 | 109 |
| APPENDIX-PHOTOGRAPHS OF EUT CONSTRUCTIONAL DETAILS                    |     |



**1. GENERAL INFORMATION**
**1.1 GENERAL DESCRIPTION OF EUT**

|                         |   |
|-------------------------|---|
| Equipment               | Smart phone   |
| Trade Mark              | Blackview   |
| Model Name.             | BV9300  |
| Family Model            | N/A   |
| Model Difference        | N/A   |
| The EUT is Smart phone  |   |
| Operation Frequency:    | 802.11b/g/n(20MHz): 2412~2472MHz<br>802.11n(40MHz):2422~2462MHz   |
| Modulation Type:        | IEEE 802.11b : DSSS (DBPSK, DQPSK, CCK)<br>IEEE 802.11g/n (HT20/HT40) : OFDM<br>(64QAM, 16QAM, QPSK, BPSK)  |
| Bit Rate of Transmitter | 802.11b:11/5.5/2/1 Mbps<br>802.11g:54/48/36/24/18/12/9/6Mbps<br>802.11n(20MHz) use 800 ns GI:<br>65.0/58.5/52.0/39.0/26.0/19.5/13.0/6.5 Mbps (MCS0~MCS7)<br>802.11n(40MHz) use 800 ns GI:<br>13.5/27/40.5/54/81/108/121.5/135Mbps |
| Adaptive/non-adaptive   | Adaptive equipment  |
| Receiver categories     | 1   |
| Number Of Channel       | Please see Note 2.  |
| Antenna Designation     | PIFA Antenna  |
| Antenna Gain(Peak)      | -0.6 dBi  |
| Channel List            | Refer to below  |
| Adapter                 | Model: QA-0300CE03<br>Input: 100-240V~50/60Hz 0.8A<br>Output: (pd)5.0V---3.0A or 9.0V---3.0A<br>or 12.0V---2.5A or 15.0V---2.0A<br>or 20.0V---1.5A<br>(PPS)3.3V-11.0V---3.0A(33.0W MAX)   |
| Battery                 | DC 3.85V, 15080mAh, 58.058Wh  |
| Rating                  | DC 3.85V from battery or DC 5V from adapter   |
| I/O Ports               | Refer to users manual   |
| Hardware Version        | TE177_MB_V1.2   |
| Software Version        | TE177_DK_DK042_6789_S0_RU   |



Note:

1. For a more detailed features description, please refer to the manufacturer's specifications or the User's Manual.
- 2.

| Channel List |                 |         |                 |         |                 |         |                 |
|--------------|-----------------|---------|-----------------|---------|-----------------|---------|-----------------|
| Channel      | Frequency (MHz) | Channel | Frequency (MHz) | Channel | Frequency (MHz) | Channel | Frequency (MHz) |
| 01           | 2412            | 05      | 2432            | 09      | 2452            | 13      | 2472            |
| 02           | 2417            | 06      | 2437            | 10      | 2457            |         |                 |
| 03           | 2422            | 07      | 2442            | 11      | 2462            |         |                 |
| 04           | 2427            | 08      | 2447            | 12      | 2467            |         |                 |

1.2 INFORMATION ABOUT THE EUT

**a) The type of modulation used by the equipment:**

- FHSS
- other forms of modulation

**b) In case of FHSS modulation:**

- In case of non-Adaptive Frequency Hopping equipment:  
The number of Hopping Frequencies:
- In case of Adaptive Frequency Hopping Equipment:  
The maximum number of Hopping Frequencies:  
The minimum number of Hopping Frequencies:
- The (average) Dwell Time:

**c) Adaptive / non-adaptive equipment:**

- non-adaptive Equipment
- adaptive Equipment without the possibility to switch to a non-adaptive mode
- adaptive Equipment which can also operate in a non-adaptive mode

**d) In case of adaptive equipment:**

The maximum Channel Occupancy Time implemented by the equipment: 1.117ms

- The equipment has implemented an LBT based DAA mechanism
- In case of equipment using modulation different from FHSS:
  - The equipment is Frame Based equipment
  - The equipment is Load Based equipment
  - The equipment can switch dynamically between Frame Based and Load Based equipment
- The CCA time implemented by the equipment: /  $\mu$ s
  - The equipment has implemented a non-LBT based DAA mechanism
  - The equipment can operate in more than one adaptive mode

**e) In case of non-adaptive Equipment:**

The maximum RF Output Power (e.i.r.p.):

The maximum (corresponding) Duty Cycle:

Equipment with dynamic behaviour, that behaviour is described here. (e.g. the different combinations of duty cycle and corresponding power levels to be declared):

**f) The worst case operational mode for each of the following tests:**

- RF Output Power  
802.11 b
- Power Spectral Density  
802.11 b
- Duty cycle, Tx-Sequence, Tx-gap  
N/A
- Accumulated Transmit time, Frequency Occupation & Hopping Sequence (only for FHSS equipment)  
N/A
- Hopping Frequency Separation (only for FHSS equipment)  
N/A
- Medium Utilization  
N/A
- Adaptivity  
802.11 b
- Nominal Channel Bandwidth  
802.11 n40
- Transmitter unwanted emissions in the OOB domain  
802.11 g
- Transmitter unwanted emissions in the spurious domain  
802.11b
- Receiver spurious emissions  
802.11 b
- Receiver Blocking  
802.11 g

**g) The different transmit operating modes (tick all that apply):**

- Operating mode 1: Single Antenna Equipment
  - Equipment with only one antenna
  - Equipment with two diversity antennas but only one antenna active at any moment in time
  - Smart Antenna Systems with two or more antennas, but operating in a (legacy) mode where only one antenna is used (e.g. IEEE 802.11™ [i.3] legacy mode in smart antenna systems)
  - Operating mode 2: Smart Antenna Systems - Multiple Antennas without beam forming
    - Single spatial stream / Standard throughput / (e.g. IEEE 802.11™ [i.3] legacy mode)
    - High Throughput (> 1 spatial stream) using Nominal Channel Bandwidth 1
    - High Throughput (> 1 spatial stream) using Nominal Channel Bandwidth 2

NOTE 1: Add more lines if more channel bandwidths are supported.

- Operating mode 3: Smart Antenna Systems - Multiple Antennas with beam forming
  - Single spatial stream / Standard throughput (e.g. IEEE 802.11™ [i.3] legacy mode)
  - High Throughput (> 1 spatial stream) using Nominal Channel Bandwidth 1
  - High Throughput (> 1 spatial stream) using Nominal Channel Bandwidth 2



NOTE 2: Add more lines if more channel bandwidths are supported.

**h) In case of Smart Antenna Systems:**

- The number of Receive chains:
- The number of Transmit chains:
  - symmetrical power distribution
  - asymmetrical power distribution

In case of beam forming, the maximum (additional) beam forming gain: ..... dB

NOTE: The additional beam forming gain does not include the basic gain of a single antenna.

**i) Operating Frequency Range(s) of the equipment:**

- Operating Frequency Range 1: 2412 MHz to 2472 MHz
- Operating Frequency Range 2: 2422 MHz to 2462 MHz

NOTE: Add more lines if more Frequency Ranges are supported.

**j) Nominal Channel Bandwidth(s):**

- Nominal Channel Bandwidth 1: 17.702MHz (n20)
- Nominal Channel Bandwidth 2: 36.188MHz(n40)

NOTE: Add more lines if more channel bandwidths are supported.

**k) Type of Equipment (stand-alone, combined, plug-in radio device, etc.):**

- Stand-alone
- Combined Equipment (Equipment where the radio part is fully integrated within another type of equipment)
- Plug-in radio device (Equipment intended for a variety of host systems)
- Other

**l) The normal and the extreme operating conditions that apply to the equipment:**

**Normal operating conditions (if applicable):**

Operating temperature: 15°C~35°C

Other (please specify if applicable): .....

**Extreme operating conditions:**

Operating temperature range: Minimum: -10°C Maximum 40°C

Other (please specify if applicable): ..... Minimum: ..... Maximum .....

Details provided are for the:

- stand-alone equipment
- combined (or host) equipment
- test jig

**m) The intended combination(s) of the radio equipment power settings and one or more antenna assemblies and their corresponding e.i.r.p. levels:**

- Antenna Type: PIFA Antenna

Integral Antenna (information to be provided in case of conducted measurements)

Antenna Gain: -0.6 dBi

If applicable, additional beamforming gain (excluding basic antenna gain): ..... dB

Temporary RF connector provided

No temporary RF connector provided

Dedicated Antennas (equipment with antenna connector)

Single power level with corresponding antenna(s)

Multiple power settings and corresponding antenna(s)

Number of different Power Levels: .....

Power Level 1: ..... dBm

Power Level 2: ..... dBm

Power Level 3: ..... dBm

NOTE 1: Add more lines in case the equipment has more power levels.

NOTE 2: These power levels are conducted power levels (at antenna connector).

- For each of the Power Levels, provide the intended antenna assemblies, their corresponding gains (G) and the resulting e.i.r.p. levels also taking into account the beamforming gain (Y) if applicable

**Power Level 1:** ..... dBm

Number of antenna assemblies provided for this power level: .....

| Assembly # | Gain (dBi) | e.i.r.p. (dBm) | Part number or model name |
|------------|------------|----------------|---------------------------|
| 1          | -0.6       | 16.04          |                           |
| 2          |            |                |                           |
| 3          |            |                |                           |

NOTE 3: Add more rows in case more antenna assemblies are supported for this power level.

**Power Level 2:** ..... dBm

Number of antenna assemblies provided for this power level: .....

| Assembly # | Gain (dBi) | e.i.r.p. (dBm) | Part number or model name |
|------------|------------|----------------|---------------------------|
| 1          |            |                |                           |
| 2          |            |                |                           |
| 3          |            |                |                           |

NOTE 4: Add more rows in case more antenna assemblies are supported for this power level.

**Power Level 3:** ..... dBm

Number of antenna assemblies provided for this power level: .....

| Assembly # | Gain (dBi) | e.i.r.p. (dBm) | Part number or model name |
|------------|------------|----------------|---------------------------|
| 1          |            |                |                           |
| 2          |            |                |                           |
| 3          |            |                |                           |

NOTE 5: Add more rows in case more antenna assemblies are supported for this power level.

**n) The nominal voltages of the stand-alone radio equipment or the nominal voltages of the combined (host) equipment or test jig in case of plug-in devices:**

Details provided are for the:

- stand-alone equipment
- combined (or host) equipment
- test jig

Supply Voltage  AC mains State AC voltage ..... V  
 DC State DC voltage: DC 3.85V

In case of DC, indicate the type of power source

- Internal Power Supply
- External Power Supply or AC/DC adapter: DC 5V
- Battery: DC 3.85V
- Other: .....

**o) Describe the test modes available which can facilitate testing:**

See section 1.3

**p) The equipment type (e.g. Bluetooth®, IEEE 802.11™ [i.3], IEEE 802.15.4™ [i.4], proprietary, etc.):**

IEEE 802.11™ [i.3]

**q) If applicable, the statistical analysis referred to in clause 5.4.1 q)**

(to be provided as separate attachment)

**r) If applicable, the statistical analysis referred to in clause 5.4.1 r)**

(to be provided as separate attachment)

**s) Geo-location capability supported by the equipment:**

- Yes
- The geographical location determined by the equipment as defined in clause 4.3.1.13.2 or clause 4.3.2.12.2 is not accessible to the user
- No

**t) Describe the minimum performance criteria that apply to the equipment (see clause 4.3.1.12.3 or clause 4.3.2.11.3):**

**802.11g(CH13) /PER=0.99%**

.....  
 .....

1.3 TEST CONDITIONS AND CHANNEL

|                   | Normal Test Conditions | Extreme Test Conditions |
|-------------------|------------------------|-------------------------|
| Temperature       | 15°C - 35°C            | 40°C ~ -10°C Note: (1)  |
| Relative Humidity | 20% - 75%              | N/A                     |
| Supply Voltage    | DC 3.85V               | /                       |

802.11b/11g/11n(20M)

| Test Channel | EUT Channel | Test Frequency (MHz) |
|--------------|-------------|----------------------|
| lowest       | CH01        | 2412                 |
| middle       | CH07        | 2442                 |
| highest      | CH13        | 2472                 |

802.11n(40M)

| Test Channel | EUT Channel | Test Frequency (MHz) |
|--------------|-------------|----------------------|
| lowest       | CH03        | 2422                 |
| middle       | CH07        | 2442                 |
| highest      | CH11        | 2462                 |

Note:

- (1) The HT 40°C and LT -10°C was declared by manufacturer, The EUT couldn't be operate normally with higher or lower temperature.
- (2) The measurements are performed at the highest, middle, lowest available channels.

#### 1.4 DESCRIPTION OF TEST CONDITIONS

E-1  
EUT

1.5 DESCRIPTION OF SUPPORT UNITS

The EUT has been tested as an independent unit together with other necessary accessories or support units. The following support units or accessories were used to form a representative test configuration during the tests.

| Item | Equipment   | Model/Type No. | Series No. | Note |
|------|-------------|----------------|------------|------|
| E-1  | Smart phone | BV9300         | N/A        | EUT  |
|      |             |                |            |      |
|      |             |                |            |      |
|      |             |                |            |      |
|      |             |                |            |      |
|      |             |                |            |      |
|      |             |                |            |      |

| Item | Type | Shielded Type | Ferrite Core | Length | Note |
|------|------|---------------|--------------|--------|------|
|      |      |               |              |        |      |
|      |      |               |              |        |      |
|      |      |               |              |        |      |
|      |      |               |              |        |      |
|      |      |               |              |        |      |

Note:

- (1) The support equipment was authorized by Declaration of Confirmation.
- (2) For detachable type I/O cable should be specified the length in cm in 『Length』 column.



### 1.6 EQUIPMENTS LIST FOR ALL TEST ITEMS

| EQUIPMENT TYPE                                     | Manufacturer       | Type No.       | Serial No.     | Last calibration         | Calibrated until         | Calibration period |
|--|--------------------|----------------|----------------|--------------------------|--------------------------|--------------------|
| EMI Test Receiver                                  | R&S                | ESPI7          | 101318         | 2022.04.06               | 2023.04.05               | 1 year             |
| Bilog Antenna                                      | TESEQ              | CBL6111D       | 31216          | 2022.03.30<br>2023.03.16 | 2023.03.29<br>2024.03.15 | 1 year             |
| Turn Table   | EM                 | SC100_1        | 60531          | N/A                      | N/A                      | N/A                |
| Antnna Mast  | EM                 | SC100          | N/A            | N/A                      | N/A                      | N/A                |
| Horn Antenna                                       | EM                 | EM-AH-10180    | 2011071402     | 2022.03.31               | 2025.03.30               | 3 year             |
| Horn Ant   | Schwarzbeck        | BBHA 9170      | 9170-181       | 2022.11.07               | 2023.11.06               | 1 year             |
| Test Cable (30MHz-1GHz)                            | N/A                | R-01           | N/A            | 2022.06.17               | 2025.06.16               | 3 year             |
| Test Cable (1-18GHz)                               | N/A                | R-02           | N/A            | 2022.06.17               | 2025.06.16               | 3 year             |
| 50Ω Coaxial Switch                                 | Anritsu            | MP59B          | 6200983705     | 2020.05.11               | 2023.05.10               | 3 year             |
| Pre-Amplifier                                      | EMC                | EMC051835SE    | 980246         | 2022.06.17               | 2023.06.16               | 1 year             |
| Spectrum Analyzer                                  | Agilent            | E4407B         | MY45108040     | 2022.04.01<br>2023.03.31 | 2023.03.31<br>2024.03.30 | 1 year             |
| Filter   | TRILTHIC           | 2400MHz        | 29             | 2020.04.07               | 2023.04.06               | 3 year             |
| Attenuator   | Weinschel          | 33-10-33       | AR4010         | 2020.04.07               | 2023.04.06               | 3 year             |
| Attenuator   | Weinschel          | 24-20-34       | BP4485         | 2020.04.07               | 2023.04.06               | 3 year             |
| MXA Signal Analyzer                                | Agilent            | N9020A         | MY49100060     | 2022.06.17               | 2023.06.16               | 1 year             |
| ESG VETCTOR SIGNAL GENERAROR                       | Agilent            | E4438C         | MY45093347     | 2022.04.01<br>2023.03.21 | 2023.03.31<br>2024.03.20 | 1 year             |
| Power Splitter                                     | Mini-Circuits/ USA | ZN2PD-63-S+    | SF025101428    | 2020.04.07               | 2023.04.06               | 3 year             |
| Coupler  | Mini-Circuits      | ZADC-10-63-S + | SF794101410    | 2020.04.07               | 2023.04.06               | 3 year             |
| Directional Coupler                                | MCLI/USA           | CB11-20        | 0D2L51502      | 2020.07.17               | 2023.07.16               | 3 year             |
| Attenuator   | Agilent            | 8495B          | MY42147029     | 2020.04.13               | 2023.04.12               | 3 year             |
| Power Meter  | DARE               | RPR3006W       | 15I00041SNO 84 | 2022.06.17               | 2023.06.16               | 1 year             |
| MXG Vector Signal Generator                        | Agilent            | N5182A         | MY47070317     | 2022.06.16               | 2023.06.15               | 1 year             |
| Wideband Radio Communication Tester Specifications | R&S                | CMW500         | 148500         | 2022.06.16               | 2023.06.15               | 1 year             |
| temporary antenna connector (Note)                 | NTS                | R001           | N/A            | N/A                      | N/A                      | N/A                |

**Note:**

We will use the temporary antenna connector (soldered on the PCB board) When conducted test And this temporary antenna connector is listed within the instrument list

## 2. SUMMARY OF TEST RESULTS

The EUT has been tested according to the following specifications:

| ETSI EN 300 328 V2.2.2 (2019-07) |   |                                  |
|----------------------------------|---|----------------------------------|
| Clause                           | Test Item   | Results                          |
| <b>TRANSMITTER PARAMETERS</b>    |   |                                  |
| 4.3.2.2                          | RF Output Power                                       | Pass                             |
| 4.3.2.3                          | Power Spectral Density                                | Pass                             |
| 4.3.2.4                          | Duty cycle, Tx-Sequence, Tx-gap                       | Pass                             |
| 4.3.2.5                          | Medium Utilization (MU) factor                        | Not Applicable<br>(See Note 1/2) |
| 4.3.2.6                          | Adaptivity  | Pass                             |
| 4.3.2.7                          | Occupied Channel Bandwidth                            | Pass                             |
| 4.3.2.8                          | Transmitter unwanted emission in the OOB domain       | Pass                             |
| 4.3.2.9                          | Transmitter unwanted emissions in the spurious domain | Pass                             |
| <b>RECEIVER PARAMETERS</b>       |   |                                  |
| 4.3.2.10                         | Receiver Spurious Emissions                           | Pass                             |
| 4.3.2.11                         | Receiver Blocking                                     | Pass                             |

Note:

1. These requirements do not apply for equipment with a maximum declared RF output power of less than 10 dBm EIRP or for equipment when operating in a mode where the RF output power is less than 10 dBm EIRP.
2. These requirements apply to non-adaptive frequency hopping equipment or to adaptive frequency hopping equipment operating in a non-adaptive mode.
3. The antenna gain provided by customer is used to calculate the EIRP result. NTEK is not responsible for the accuracy of antenna gain parameter

## 2.1 TEST FACILITY

Shenzhen NTEK Testing Technology Co., Ltd.

Add. : 1/F, Building E, Fenda Science Park, Sanwei Community, Xixiang Street, Bao'an District, Shenzhen 518126 P.R. China

FCC Registered No.: 463705 IC Registered No.:9270A-1

CNAS Registration No.:L5516

## 2.2 MEASUREMENT UNCERTAINTY

The reported uncertainty of measurement  $y \pm U$ , where expanded uncertainty  $U$  is based on a standard uncertainty multiplied by a coverage factor of  $k=2$ , providing a level of confidence of approximately **95** %.

| No. | Item                          | Uncertainty             |
|-----|-------------------------------|-------------------------|
| 1   | Radio Frequency               | $\pm 1.38\text{dB}$     |
| 2   | Total RF power, conducted     | $\pm 0.16\text{dB}$     |
| 3   | RF power density, conducted   | $\pm 0.16\text{dB}$     |
| 4   | All emissions, radiated       | $\pm 0.21\text{dB}$     |
| 5   | Temperature                   | $\pm 0.5^\circ\text{C}$ |
| 6   | Humidity                      | $\pm 2\%$               |
| 7   | DC and low Frequency voltages | $\pm 0.04\%$            |

### 2.3 MAXIMUM MEASUREMENT UNCERTAINTY (FOR ETSI EN 300 328)

For the test methods, according to ETSI EN 300 328 standard, the measurement uncertainty figures shall be calculated in accordance with ETR 100 028-1[4] and shall correspond to an expansion factor(coverage factor)  $k=1.96$  or  $k=2$  (which provide confidence levels of respectively **95 %** and **95.45 %** in the case where the distributions characterizing the actual measurement uncertainties are normal (Gaussian)).

Maximum measurement uncertainty

| No. | Item                              | Uncertainty             |
|-----|-----------------------------------|-------------------------|
| 1   | Occupied Channel Bandwidth        | $\pm 5\%$               |
| 2   | RF output Power,conducted         | $\pm 1.5\text{dB}$      |
| 3   | Power Spectral Density, conducted | $\pm 3\text{dB}$        |
| 4   | Unwanted emissions, conducted     | $\pm 3\text{dB}$        |
| 5   | All emissions,radiated            | $\pm 6\text{dB}$        |
| 6   | Temperature                       | $\pm 3^{\circ}\text{C}$ |
| 7   | Humidity                          | $\pm 3\%$               |
| 9   | Time                              | $\pm 5\%$               |

### 3. TEST PROCEDURES AND RESULTS

#### 3.1 EQUIVALENT ISOTROPIC RADIATED POWER

##### 3.1.1 LIMITS OF EQUIVALENT ISOTROPIC RADIATED POWER

Refer to chapter 4.3.2.2.3 of ETSI EN 300 328 V2.2.2 (2019-07)

| RF OUTPUT POWER  |   |
|--|---|
| Condition  | Limit   |
| <input type="checkbox"/> Non-adaptive wide band modulations systems        | Equal to or less than the value declared by the supplier.<br>This declared value shall be equal to or less than 20 dBm. |
| <input checked="" type="checkbox"/> Adaptive wide band modulations systems | ≤20dBm  |

##### 3.1.2 TEST PROCEDURE

Refer to chapter 5.4.2.2 of ETSI EN 300 328 V2.2.2 (2019-07)

| Measurement   |   |
|---|---|
| <input checked="" type="checkbox"/> Conducted measurement | <input type="checkbox"/> Radiated measurement |

##### 3.1.3 TEST SETUP

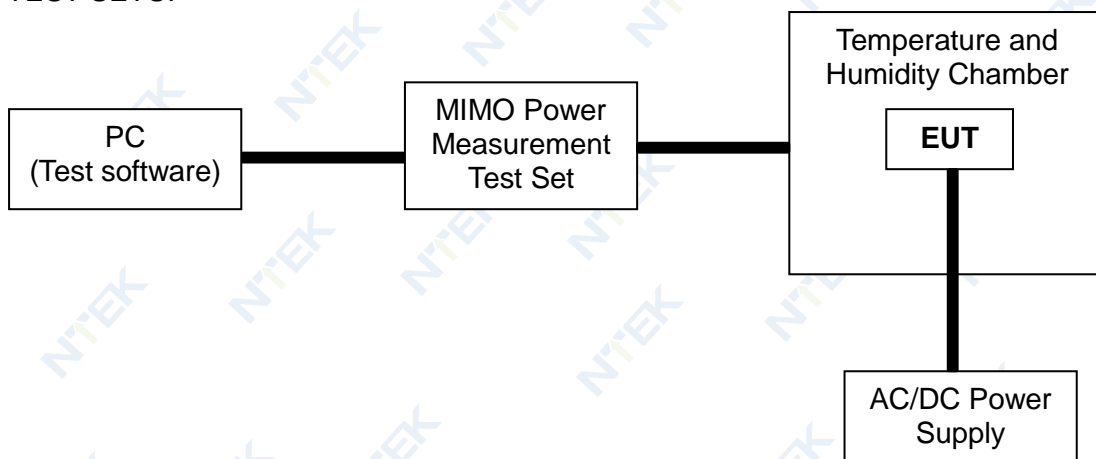

## 3.1.4 TEST RESULTS

|               |                               |                    |          |
|---------------|-------------------------------|--------------------|----------|
| EUT :         | Smart phone                   | Model Name :       | BV9300   |
| Temperature : | 20°C                          | Relative Humidity: | 55 %     |
| Pressure :    | 1012 hPa                      | Test Voltage :     | DC 3.85V |
| Test Mode :   | 802.11 b/g/n(HT20, HT40) Mode |                    |          |

Test data reference attachment



### 3.2. PEAK POWER DENSITY

#### 3.2.1 LIMITS OF POWER SPECTRAL DENSITY

Refer to chapter 4.3.2.3.3 of ETSI EN 300 328 V2.2.2 (2019-07)

| RF OUTPUT POWER   |             |
|---|-------------|
| Condition   | Limit       |
| For equipment using wide band modulations other than FHSS | ≤10 dBm/MHz |

#### 3.2.2 TEST PROCEDURE

Refer to chapter 5.4.3.2 of ETSI EN 300 328 V2.2.2 (2019-07)

| Measurement   |   |
|---|---|
| <input checked="" type="checkbox"/> Conducted measurement | <input type="checkbox"/> Radiated measurement |

The setting of the Spectrum Analyzer

|                 |   |
|-----------------|---|
| Start Frequency | 2400MHz   |
| Stop Frequency  | 2483.5MHz   |
| Detector        | RMS   |
| Sweep Point     | > 8 350; for spectrum analysers not supporting this number of sweep points, the frequency band may be segmented   |
| Sweep time:     | For non-continuous transmissions: 2 × Channel Occupancy Time × number of sweep points<br>For continuous transmissions: 10 s; the sweep time may be increased further until a value where the sweep time has no further impact anymore on the RMS value of the signal. |
| RBW / VBW       | 10KHz / 30KHz   |

#### 3.2.3 TEST SETUP

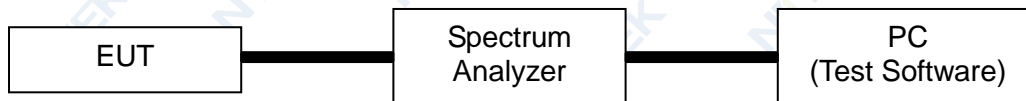

## 3.2.4 TEST RESULTS

|               |                               |                    |          |
|---------------|-------------------------------|--------------------|----------|
| EUT :         | Smart phone                   | Model Name :       | BV9300   |
| Temperature : | 26°C                          | Relative Humidity: | 60 %     |
| Pressure :    | 1012 hPa                      | Test Voltage :     | DC 3.85V |
| Test Mode :   | 802.11 b/g/n(HT20, HT40) Mode |                    |          |

Test data reference attachment

### 3.3. OCCUPIED CHANNEL BANDWIDTH

#### 3.3.1 LIMITS OF OCCUPIED CHANNEL BANDWIDTH

Refer to chapter 4.3.2.7.3 of ETSI EN 300 328 V2.2.2 (2019-07)

| OCCUPIED CHANNEL BANDWIDTH |   |  |
|----------------------------|---|--|
| Condition                  |   | Limit  |
| All types of equipment     |   | Shall fall completely within the band 2400 to 2483.5 MHz |
| Additional requirement     | For non-adaptive using wide band modulations other than FHSS system and E.I.R.P >10 dBm | Less than 20 MHz   |
|                            | For non-adaptive frequency hopping system and E.I.R.P >10 dBm                           | Less than 5 MHz  |

#### 3.3.2 TEST PROCEDURE

Refer to chapter 5.4.7.2 of ETSI EN 300 328 V2.2.2 (2019-07)

| Measurement   |   |
|---|---|
| <input checked="" type="checkbox"/> Conducted measurement | <input type="checkbox"/> Radiated measurement |

The setting of the Spectrum Analyzer

|                  |  |
|------------------|--|
| Center Frequency | The centre frequency of the channel under test |
| Frequency Span   | 2 x Nominal Channel Bandwidth                  |
| Detector         | RMS  |
| RBW              | ~ 1 % of the span without going below 1 %      |
| VBW              | 3 x RBW  |
| Trace            | Max hold                                       |
| Sweep time       | 1s   |

#### 3.3.3 DEVIATION FROM TEST STANDARD

No deviation

#### 3.3.4 TEST SETUP



These measurements only were performed at normal test conditions. The measurement shall be performed only on the lowest and the highest frequency within the ststed frequency range. In case of conducted measurements the transmitter shall be connected to the measuring equipment via a suitable attenuator. Controlling software has been activated to set the EUT on specific status.

## 3.3.5 TEST RESULTS

|               |   |                     |          |
|---------------|---|---------------------|----------|
| EUT :         | Smart phone   | Model Name :        | BV9300   |
| Temperature : | 26°C  | Relative Humidity : | 60 %     |
| Pressure :    | 1012 hPa  | Test Voltage :      | DC 3.85V |
| Test Mode :   | 802.11b/g/n(HT20, HT40) Mode CH1 / CH13, CH3 / CH11 |                     |          |

Test data reference attachment

### 3.4. TRANSMITTER UNWANTED EMISSIONS IN THE OUT-OF-BAND DOMAIN

#### 3.4.1 LIMITS OF TRANSMITTER UNWANTED EMISSIONS IN THE OUT-OF-BAND DOMAIN

Refer to chapter 4.3.2.8.3 of ETSI EN 300 328 V2.2.2 (2019-07)

| TRANSMITTER UNWANTED EMISSIONS IN THE OUT-OF-BAND DOMAIN |  |
|--|--|
| Condition  | Limit  |
| Under all test conditions                                | The transmitter unwanted emissions in the out-of-band domain but outside the allocated band, shall not exceed the values provided by the mask in below figure. |

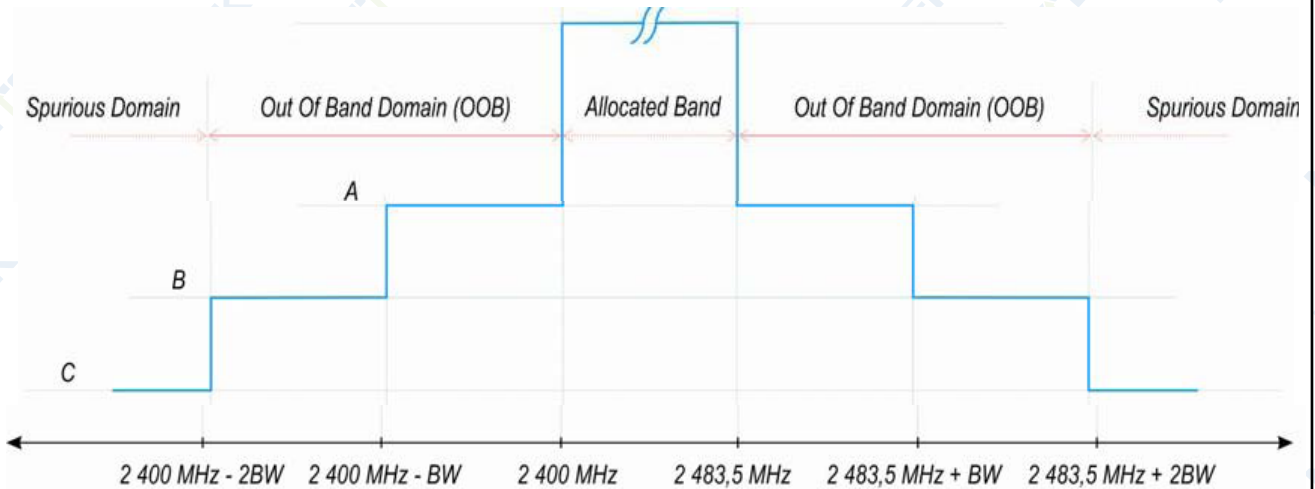

- A: -10 dBm/MHz e.i.r.p.
- B: -20 dBm/MHz e.i.r.p.
- C: Spurious Domain limits

BW = Occupied Channel Bandwidth in MHz or 1 MHz whichever is greater

#### 3.4.2 TEST PROCEDURE

Refer to chapter 5.4.8.2 of ETSI EN 300 328 V2.2.2 (2019-07)

| Measurement   |   |
|---|---|
| <input checked="" type="checkbox"/> Conducted measurement | <input type="checkbox"/> Radiated measurement |

The setting of the Spectrum Analyzer

|                          |   |
|--------------------------|---|
| Span                     | 0Hz   |
| Filter Mode              | Channel Filter  |
| Trace Mode               | Max Hold  |
| Trigger Mode             | Video trigger; in case video triggering is not possible, an external trigger source may be used |
| Detector                 | RMS   |
| Sweep Point / Sweep Mode | Sweep Time [s] / (1 μs) or 5 000 whichever is greater/ Continuous                               |
| RBW / VBW                | 1MHz / 3MHz   |

### 3.4.3 DEVIATION FROM TEST STANDARD

No deviation

### 3.4.4 TEST SETUP

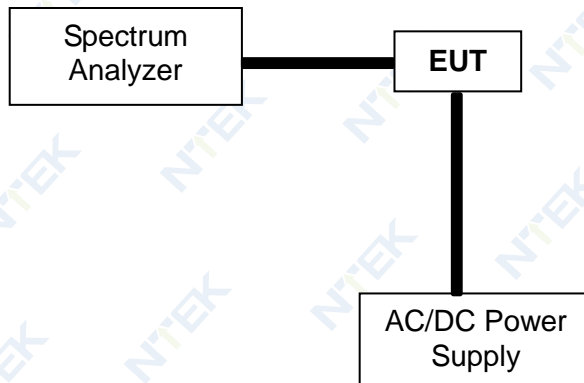

According to the ETSI EN 300328 V2.2.2 clause 5.4.8.1: These measurements shall only be performed at normal test conditions. For equipment using FHSS modulation, the measurements shall be performed during normal operation (hopping).

For equipment using wide band modulations other than FHSS, the measurement shall be performed at the lowest and the highest channel on which the equipment can operate. These operating channels shall be recorded.

The equipment shall be configured to operate under its worst case situation with respect to output power.

If the equipment can operate with different Nominal Channel Bandwidths (e.g. 20 MHz and 40 MHz), then each channel bandwidth shall be tested separately.



## 3.4.5 TEST RESULTS

|               |                               |                     |          |
|---------------|-------------------------------|---------------------|----------|
| EUT :         | Smart phone                   | Model Name :        | BV9300   |
| Temperature : | 24 °C                         | Relative Humidity : | 54%      |
| Pressure :    | 1010 hPa                      | Test Power :        | DC 3.85V |
| Test Mode :   | 802.11 b/g/n(HT20, HT40) Mode |                     |          |

Test data reference attachment

3.5. ADAPTIVE (CHANNEL ACCESS MECHANISM)

3.5.1 APPLICABILITY OF ADAPTIVE REQUIREMENTS AND LILT FOR WIDE BAND MODULATION TECHNIQUES

Refer to chapter 4.3.2.6 of ETSI EN 300 328 V2.2.2 (2019-07)

| Requirement                                 | Operational Mode   |  |  |  |
|---|--|--|--|--|
|   | <input type="checkbox"/> Non-LBT based Detect and Avoid                      | <input checked="" type="checkbox"/> LBT based Detect and Avoid |  |  |
|   |  | <input type="checkbox"/> Frame Based Equipment                 | <input checked="" type="checkbox"/> Load Based Equipment (CCA using 'energy detect') | <input type="checkbox"/> Load Based Equipment (CCA not using any of the mechanisms referenced as note 2) |
| Minimum Clear Channel Assessment (CCA) Time | NA   | not less than 18 us (see note 1)                               | (see note 2)   | not less than 18 us (see note 1)   |
| Maximum Channel Occupancy (COT) Time        | <40 ms   | 1ms to 10 ms   | (see note 2)   | (13/32)*q ms (see note 3)  |
| Minimum Idle Period                         | 5 % minimum of 100 µs  | 5% of COT  | (see note 2)   | NA   |
| Extended CCA check                          | NA   | NA   | (see note 2)   | R*CCA (see note 4)   |
| Short Control Signalling Transmissions      | Maximum duty cycle of 10% within an observation period of 50 ms (see note 5) |  |  |  |

- Note 1: The CCA time used by the equipment shall be declared by the supplier.
- Note 2: Load Based Equipment may implement an LBT based spectrum sharing mechanism based on the Clear Channel Assessment (CCA) mode using energy detect as described in IEEE 802.11™-2012 [i.3], clause 9, clause 10, clause 16, clause 17, clause 19 and clause 20, or in IEEE 802.15.4™-2011 [i.4], clause 4, clause 5 and clause 8 providing the equipment complies with the conformance requirements referred to in clause 4.3.2.6.3.4.
- Note 3: q is selected by the manufacturer in the range [4...32]
- Note 4: The value of R shall be randomly selected in the range [1...q]
- Note 5: Adaptive equipment may or may not have Short Control Signaling Transmissions.

**Interference threshold level**

The detection threshold shall be proportional to the transmit power of the transmitter: for a 20 dBm e.i.r.p. transmitter the detection threshold level (TL) shall be equal to or less than -70 dBm/MHz at the input to the receiver assuming a 0 dBi (receive) antenna assembly. This threshold level (TL) may be corrected for the (receive) antenna assembly gain (G); however, beamforming gain (Y) shall not be taken into account. For power levels less than 20 dBm e.i.r.p., the detection threshold level may be relaxed to:

$$TL = -70 \text{ dBm/MHz} + 10 \times \log_{10} (100 \text{ mW} / P_{out}) \text{ (Pout in mW e.i.r.p.)}$$

**Table 9: Unwanted Signal parameters**

| Wanted signal mean power from companion device (dBm)   | Unwanted signal frequency (MHz) | Unwanted CW signal power (dBm) |
|--|---------------------------------|--------------------------------|
| -30/ sufficient to maintain the link(see note 2)   | 2 395 or 2 488,5 (see note 1)   | -35 (see note 2)               |
| <p>NOTE 1: The highest frequency shall be used for testing operating channels within the range 2 400 MHz to 2 442 MHz, while the lowest frequency shall be used for testing operating channels within the range 2 442 MHz to 2 483,5 MHz. See clause 5.4.6.1.</p> <p>NOTE 2: A typical value which can be used in most cases is -50 dBm/MHz.</p> <p>NOTE 3: The level specified is the level in front of the UUT antenna. In case of conducted measurements, this level has to be corrected by the actual antenna assembly gain.</p> |                                 |                                |

3.5.2 TEST PROCEDURE

Refer to chapter 5.4.6.2 of ETSI EN 300 328 V2.2.2 (2019-07)

| Measurement   |   |
|---|---|
| <input checked="" type="checkbox"/> Conducted measurement | <input type="checkbox"/> Radiated measurement |

Test method please refer to the 5.4.6.2.1.4 of ETSI EN 300 328 V2.2.2 (2019-07).

3.5.3 TEST SETUP CONFIGURATION

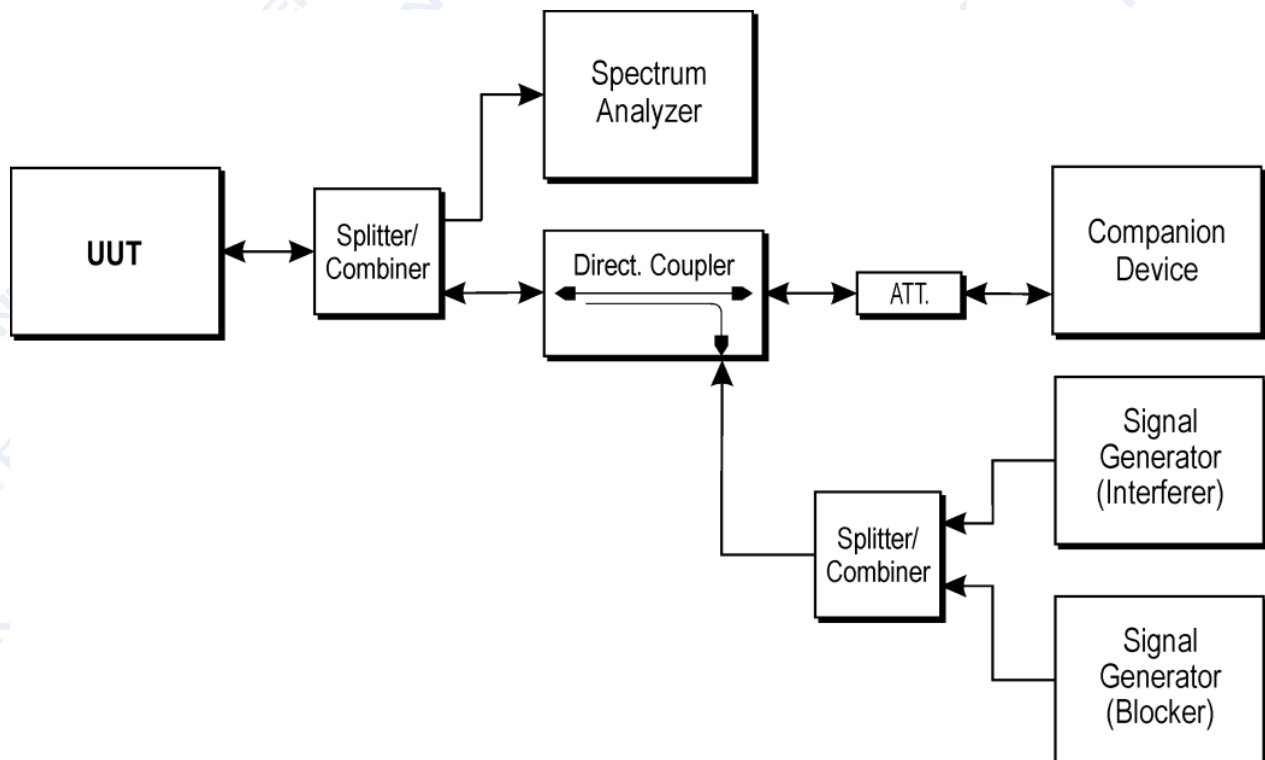

3.5.4 LIST OF MEASUREMENTS

| UUT operational Mode  |  |   |
|-----------------------|--|---|
| Frame Based Equipment | Load Based Equipment (CCA using 'energy detect') | Load Based Equipment (CCA not using any of the mechanisms referenced) |
|                       | V  |   |

| Clause        | Test Parameter                        | Remarks        | PASS/FAIL |
|---------------|---------------------------------------|----------------|-----------|
| 4.3.2.5.2.2.1 | Adaptive (Frame Based Equipment)      | Not Applicable | N/A       |
| 4.3.2.5.2.2.2 | Adaptive (Load Based Equipment)       | Applicable     | PASS      |
| 4.3.2.5.3     | Short Control Signaling Transmissions | Applicable     | PASS      |

3.5.5 INTERFERENCE THRESHOLD LEVEL

|               |   |                     |          |
|---------------|---|---------------------|----------|
| EUT :         | Smart phone                                     | Model Name :        | BV9300   |
| Temperature : | 24 °C   | Relative Humidity : | 54%      |
| Pressure :    | 1010 hPa  | Test Power :        | DC 3.85V |
| Test Mode :   | 802.11b/g/n(HT20,HT40) Mode CH1 / CH13,CH3/CH11 |                     |          |

Test data reference attachment

**3.6. TRANSMITTER UNWANTED EMISSIONS IN THE SPURIOUS DOMAIN**

**3.6.1 LIMITS OF TRANSMITTER UNWANTED EMISSIONS IN THE SPURIOUS DOMAIN**

Refer to chapter 4.3.2.9.3 of ETSI EN 300328 V2.2.2 (2019-07)

| TRANSMITTER UNWANTED EMISSIONS IN THE SPURIOUS DOMAIN |  |           |
|---|--|-----------|
| Frequency Range                                       | Maximum Power Limit<br>(E.R.P.(≤1 GHz)<br>E.I.R.P.(> 1 GHz)) | Bandwidth |
| 30 MHz to 47 MHz                                      | -36dBm   | 100 kHz   |
| 47 MHz to 74 MHz                                      | -54dBm   | 100 kHz   |
| 74 MHz to 87.5 MHz                                    | -36dBm   | 100 kHz   |
| 87.5 MHz to 118 MHz                                   | -54dBm   | 100 kHz   |
| 118 MHz to 174 MHz                                    | -36dBm   | 100 kHz   |
| 174 MHz to 230 MHz                                    | -54dBm   | 100 kHz   |
| 230 MHz to 470 MHz                                    | -36dBm   | 100 kHz   |
| 470 MHz to 694 MHz                                    | -54dBm   | 100 kHz   |
| 694 MHz to 1 GHz                                      | -36dBm   | 100 kHz   |
| 1 GHz ~ 12.75 GHz                                     | -30dBm   | 1 MHz     |

**3.6.2 TEST PROCEDURE**

Refer to chapter 5.4.9.2 of ETSI EN 300328 V2.2.2 (2019-07)

| Measurement   |  |
|---|--|
| <input checked="" type="checkbox"/> Conducted measurement | <input checked="" type="checkbox"/> Radiated measurement |

The setting of the Spectrum Analyzer

|     |                         |
|-----|-------------------------|
| RBW | 100K(<1GHz) / 1M(>1GHz) |
| VBW | 300K(<1GHz) / 3M(>1GHz) |

**3.6.3 DEVIATION FROM TEST STANDARD**

No deviation



3.6.4 TEST SETUP

Radiated measurement:

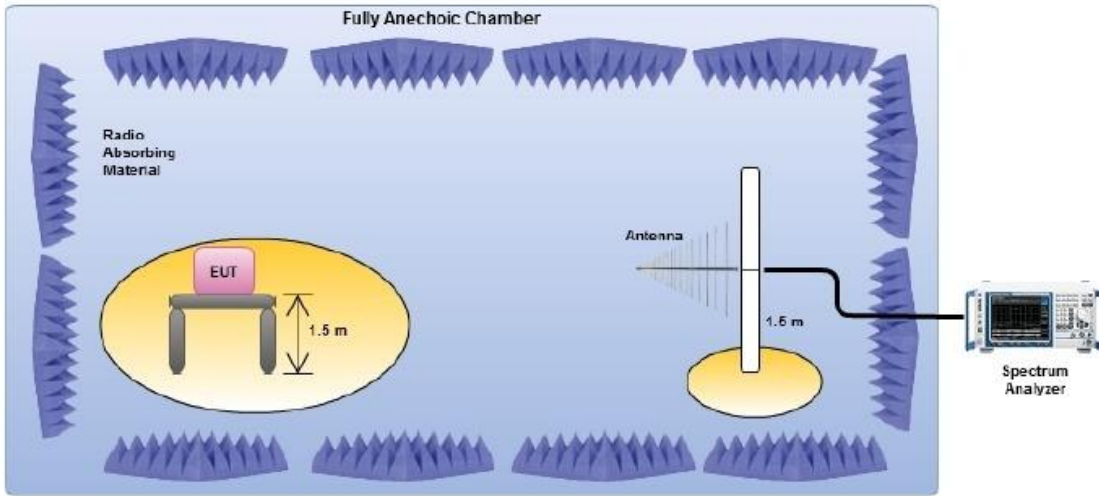

Conducted measurement:



1. For the actual test configuration, please refer to the related Item in this test report (Photographs of the Test Configuration ).
2. The measurements were performed when normal hopping was disabled. In this case measurements were performed when operating at the lowest and the highest hopping frequency.
3. The equipment was configured to operate under its worst case situation with respect to output power.
4. The test setup has been constructed as the normal use condition. Controlling software has been activated to set the EUT on specific status.

Note: The EUT was pretested with 3 orientations placed on the table for the radiated emission measurement –X, Y, and Z-plane. The Y-plane results were found as the worst case and were shown in this report.

3.6.5 TEST RESULTS (Radiated measurement)

BELOW 1 GHz WORST- CASE DATA(30 MHz ~ 1GHz)

|               |                       |                     |          |
|---------------|-----------------------|---------------------|----------|
| EUT :         | Smart phone           | Model Name :        | BV9300   |
| Temperature : | 24°C                  | Relative Humidity : | 57 %     |
| Pressure :    | 1012 hPa              | Test Voltage :      | DC 3.85V |
| Test Mode :   | TX-802.11b Mode(CH07) |                     |          |

| Polar (H/V) | Frequency | Meter Reading | Factor | Emission Level | Limits | Margin | Remark |
|-------------|-----------|---------------|--------|----------------|--------|--------|--------|
|             | (MHz)     | (dBm)         | (dB)   | (dBm)          | (dBm)  | (dB)   |        |
| V           | 44.08     | -80.77        | 14.91  | -65.86         | -54    | -11.86 | peak   |
| V           | 102.47    | -78.02        | 15.76  | -62.26         | -36    | -26.26 | peak   |
| V           | 201.70    | -79.22        | 15.26  | -63.96         | -36    | -27.96 | peak   |
| V           | 447.59    | -79.29        | 16.03  | -63.26         | -54    | -9.26  | peak   |
| V           | 561.76    | -82.54        | 14.90  | -67.64         | -36    | -31.64 | peak   |
| V           | 771.22    | -72.51        | 16.11  | -56.40         | -36    | -20.40 | peak   |
| H           | 39.24     | -74.41        | 15.71  | -58.70         | -54    | -4.70  | peak   |
| H           | 104.90    | -75.74        | 14.42  | -61.32         | -54    | -7.32  | peak   |
| H           | 201.08    | -79.65        | 15.51  | -64.14         | -36    | -28.14 | peak   |
| H           | 409.49    | -81.78        | 16.08  | -65.70         | -54    | -11.70 | peak   |
| H           | 503.06    | -73.55        | 14.30  | -59.25         | -36    | -23.25 | peak   |
| H           | 768.21    | -79.54        | 14.28  | -65.26         | -36    | -29.26 | peak   |

**Remark:**

1. Emission Level= Meter Reading+ Factor, Margin= Emission Level- Limit.
2. All the modes had been tested, but only the worst data recorded in the report.

ABOVE 1 GHz WORST- CASE DATA (1GHz ~ 12.75GHz)

|               |                                |                     |          |
|---------------|--------------------------------|---------------------|----------|
| EUT :         | Smart phone                    | Model Name :        | BV9300   |
| Temperature : | 26°C                           | Relative Humidity : | 60 %     |
| Pressure :    | 1012 hPa                       | Test Voltage :      | DC 3.85V |
| Test Mode :   | TX-802.11b Mode(CH01/CH7/CH13) |                     |          |

| Polar (H/V)                     | Frequency | Meter Reading | Factor | Emission Level | Limits | Margin | Remark |
|---------------------------------|-----------|---------------|--------|----------------|--------|--------|--------|
|                                 | (MHz)     | (dBm)         | (dB)   | (dBm)          | (dBm)  | (dB)   |        |
| <b>operation frequency:2412</b> |           |               |        |                |        |        |        |
| V                               | 2598.596  | -76.74        | 20.03  | -56.71         | -30    | -26.71 | peak   |
| V                               | 3923.962  | -69.86        | 20.14  | -49.72         | -30    | -19.72 | peak   |
| V                               | 4553.463  | -70.26        | 20.68  | -49.58         | -30    | -19.58 | peak   |
| V                               | 5698.241  | -68.73        | 19.58  | -49.15         | -30    | -19.15 | peak   |
| H                               | 2250.214  | -67.57        | 21.39  | -46.18         | -30    | -16.18 | peak   |
| H                               | 3360.72   | -73.4         | 19.98  | -53.42         | -30    | -23.42 | peak   |
| H                               | 4975.222  | -75.57        | 21.21  | -54.36         | -30    | -24.36 | peak   |
| H                               | 5802.525  | -72.29        | 19.93  | -52.36         | -30    | -22.36 | peak   |
| <b>operation frequency:2442</b> |           |               |        |                |        |        |        |
| V                               | 2687.554  | -67.67        | 20.83  | -46.84         | -30    | -16.84 | peak   |
| V                               | 5849.794  | -69.97        | 21.20  | -48.77         | -30    | -18.77 | peak   |
| V                               | 4266.388  | -75.72        | 21.25  | -54.47         | -30    | -24.47 | peak   |
| V                               | 5386.189  | -75.88        | 20.45  | -55.43         | -30    | -25.43 | peak   |
| H                               | 2521.813  | -71.27        | 21.14  | -50.13         | -30    | -20.13 | peak   |
| H                               | 4196.598  | -72.62        | 19.81  | -52.81         | -30    | -22.81 | peak   |
| H                               | 4881.056  | -72.53        | 20.20  | -52.33         | -30    | -22.33 | peak   |
| H                               | 5023.837  | -68.85        | 21.06  | -47.79         | -30    | -17.79 | peak   |
| <b>operation frequency:2472</b> |           |               |        |                |        |        |        |
| V                               | 2101.784  | -77.14        | 20.28  | -56.86         | -30    | -26.86 | peak   |
| V                               | 3616.543  | -68.07        | 21.24  | -46.83         | -30    | -16.83 | peak   |
| V                               | 4141.675  | -74.48        | 20.06  | -54.42         | -30    | -24.42 | peak   |
| V                               | 5913.261  | -75           | 19.82  | -55.18         | -30    | -25.18 | peak   |
| H                               | 2383.444  | -68.31        | 20.43  | -47.88         | -30    | -17.88 | peak   |
| H                               | 7786.954  | -69.45        | 20.31  | -49.14         | -30    | -19.14 | peak   |
| H                               | 4000.642  | -71.38        | 20.24  | -51.14         | -30    | -21.14 | peak   |
| H                               | 5471.407  | -75.96        | 20.04  | -55.92         | -30    | -25.92 | peak   |

**Remark:**

1. Emission Level= Meter Reading+ Factor, Margin= Emission Level- Limit.
2. All the modes had been tested, but only the worst data recorded in the report.

3.6.6 TEST RESULTS (Conducted measurement)

Test data reference attachment

### 3.7. RECEIVER SPURIOUS RADIATION

#### 3.7.1 LIMITS OF RECEIVER SPURIOUS RADIATION

Refer to chapter 4.3.2.10.3 of ETSI EN 300 328 V2.2.2 (2019-07)

| RECEIVER SPURIOUS EMISSIONS |  |                       |
|-----------------------------|--|-----------------------|
| Frequency Range             | Maximum Power Limit<br>(E.R.P.(≤1 GHz)<br>E.I.R.P.(> 1 GHz)) | Measurement Bandwidth |
| 30 MHz ~ 1 GHz              | -57dBm   | 100KHz                |
| 1 GHz ~ 12.75 GHz           | -47dBm   | 1MHz                  |

#### 3.7.2 TEST PROCEDURE

Refer to chapter 5.4.10.2 of ETSI EN 300 328 V2.2.2 (2019-07)

| Measurement   |  |
|---|--|
| <input checked="" type="checkbox"/> Conducted measurement | <input checked="" type="checkbox"/> Radiated measurement |

The setting of the Spectrum Analyzer

|     |                         |
|-----|-------------------------|
| RBW | 100K(<1GHz) / 1M(>1GHz) |
| VBW | 300K(<1GHz) / 3M(>1GHz) |

#### 3.7.3 DEVIATION FROM TEST STANDARD

No deviation

### 3.7.4 TEST SETUP

Radiated measurement:

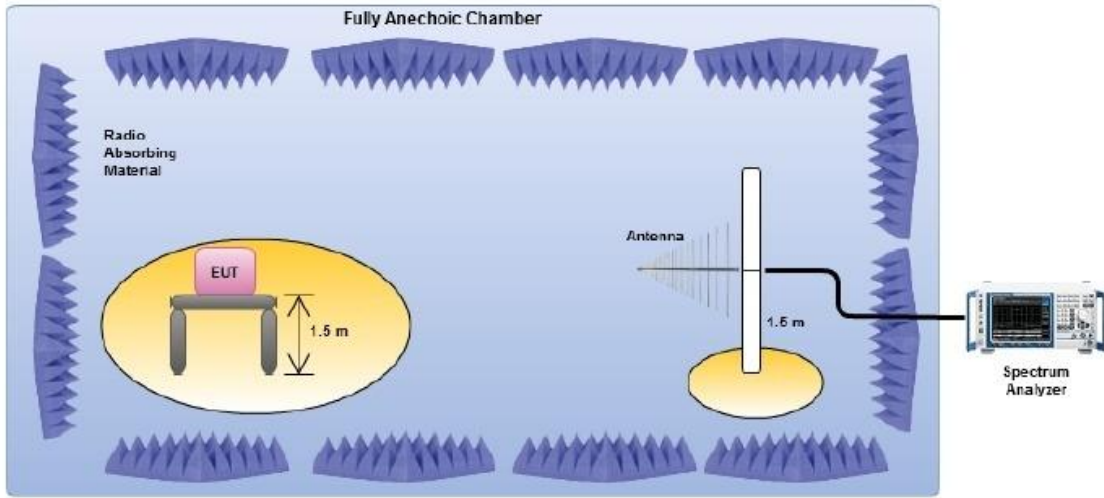

Conducted measurement:

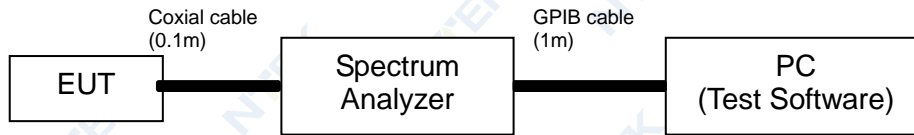

1. For the actual test configuration, please refer to the related Item in this test report (Photographs of the Test Configuration ).
2. Testing was performed when the equipment was in a receive-only mode.
3. The measurements were performed when normal hopping was disabled. In this case measurements were performed when operating at the lowest and the highest hopping frequency.
4. The test setup has been constructed as the normal use condition. Controlling software has been activated to set the EUT on specific status.

3.7.5 TEST RESULTS (Radiated measurement)

RX BELOW 1 GHz WORST- CASE DATA(30 MHz ~ 1GHz)

|               |                            |                     |          |
|---------------|----------------------------|---------------------|----------|
| EUT :         | Smart phone                | Model Name :        | BV9300   |
| Temperature : | 24°C                       | Relative Humidity : | 57 %     |
| Pressure :    | 1012 hPa                   | Test Voltage :      | DC 3.85V |
| Test Mode :   | RX Mode-802.11b Mode(CH07) |                     |          |

| Polar (H/V) | Frequency | Meter Reading | Factor | Emission Level | Limits | Margin | Remark |
|-------------|-----------|---------------|--------|----------------|--------|--------|--------|
|             | (MHz)     | (dBm)         | (dB)   | (dBm)          | (dBm)  | (dB)   |        |
| V           | 38.75     | -86.84        | 12.67  | -74.17         | -57    | -17.17 | peak   |
| V           | 89.98     | -84.70        | 13.66  | -71.04         | -57    | -14.04 | peak   |
| V           | 206.76    | -81.21        | 14.59  | -66.62         | -57    | -9.62  | peak   |
| V           | 327.38    | -85.90        | 15.26  | -70.64         | -57    | -13.64 | peak   |
| V           | 691.20    | -85.83        | 18.83  | -67.00         | -57    | -10.00 | peak   |
| V           | 785.55    | -86.33        | 19.92  | -66.41         | -57    | -9.41  | peak   |
| H           | 45.51     | -85.81        | 11.63  | -74.18         | -57    | -17.18 | peak   |
| H           | 88.85     | -84.39        | 18.96  | -65.43         | -57    | -8.43  | peak   |
| H           | 228.49    | -85.26        | 19.81  | -65.45         | -57    | -8.45  | peak   |
| H           | 465.63    | -85.01        | 18.02  | -66.99         | -57    | -9.99  | peak   |
| H           | 647.39    | -84.65        | 19.13  | -65.52         | -57    | -8.52  | peak   |
| H           | 745.15    | -84.26        | 13.01  | -71.25         | -57    | -14.25 | peak   |

**Remark:**

1. Emission Level= Meter Reading+ Factor, Margin= Emission Level- Limit.
2. All the modes had been tested, but only the worst data recorded in the report.



**RX ABOVE 1 GHz WORST- CASE DATA(1GHz ~ 12.75GHz)**

|               |                            |                   |          |
|---------------|----------------------------|-------------------|----------|
| EUT :         | Smart phone                | Model Name :      | BV9300   |
| Temperature : | 24 °C                      | Relative Humidity | 57%      |
| Pressure :    | 1010 hPa                   | Test Power :      | DC 3.85V |
| Test Mode :   | RX Mode-802.11b Mode(CH07) |                   |          |

| Polar (H/V) | Frequency | Meter Reading | Factor | Emission Level | Limits | Margin | Remark |
|-------------|-----------|---------------|--------|----------------|--------|--------|--------|
|             | (MHz)     | (dBm)         | (dB)   | (dBm)          | (dBm)  | (dB)   |        |
| V           | 2706.09   | -78.31        | 14.92  | -63.39         | -47    | -16.39 | peak   |
| V           | 3732.85   | -80.33        | 14.56  | -65.77         | -47    | -18.77 | peak   |
| V           | 4433.58   | -77.72        | 15.95  | -61.77         | -47    | -14.77 | peak   |
| V           | 4995.10   | -83.85        | 17.15  | -66.70         | -47    | -19.70 | peak   |
| V           | 5070.04   | -78.57        | 13.73  | -64.84         | -47    | -17.84 | peak   |
| V           | 6072.62   | -81.11        | 20.42  | -60.69         | -47    | -13.69 | peak   |
| H           | 2205.05   | -84.01        | 14.11  | -69.90         | -47    | -22.90 | peak   |
| H           | 3667.69   | -82.96        | 15.29  | -67.67         | -47    | -20.67 | peak   |
| H           | 4153.97   | -79.82        | 15.89  | -63.93         | -47    | -16.93 | peak   |
| H           | 4602.45   | -78.73        | 16.70  | -62.03         | -47    | -15.03 | peak   |
| H           | 5035.34   | -80.82        | 17.95  | -62.87         | -47    | -15.87 | peak   |
| H           | 5501.15   | -83.84        | 18.58  | -65.26         | -47    | -18.26 | peak   |

1. Emission Level= Meter Reading+ Factor, Margin= Emission Level- Limit.
2. All the modes had been tested, but only the worst data recorded in the report.

**3.7.6 TEST RESULTS (Conducted measurement)**

Test data reference attachment



### 3.8. RECEIVER BLOCKING

#### 3.8.1 PERFORMANCE CRITERIA

The minimum performance criterion shall be a PER less than or equal to 10 %. The manufacturer may declare alternative performance criteria as long as that is appropriate for the intended use of the equipment (see clause 5.4.1.t)).

#### 3.8.2 LIMITS OF RECEIVER BLOCKING

While maintaining the minimum performance criteria as defined in clause 4.3.2.11.3, the blocking levels at specified frequency offsets shall be equal to or greater than the limits defined for the applicable receiver category provided in table 14, table 15 or table 16.

**Table 14: Receiver Blocking parameters for Receiver Category 1 equipment**

| Wanted signal mean power from companion device (dBm) (see notes 1 and 4)                   | Blocking signal Frequency (MHz) | Blocking signal power (dBm) (see note 4) | Type of blocking signal |
|--|---------------------------------|--|-------------------------|
| (-133 dBm + 10 × log <sub>10</sub> (OCBW))<br>or -68 dBm whichever is less<br>(see note 2) | 2 380                           | -34                                      | CW                      |
|  | 2 504                           |  |                         |
| (-139 dBm + 10 × log <sub>10</sub> (OCBW))<br>or -74 dBm whichever is less<br>(see note 3) | 2 300                           |  |                         |
|  | 2 330                           |  |                         |
|  | 2 360                           |  |                         |
|  | 2524                            |  |                         |
|  | 2584                            |  |                         |
|  | 2674                            |  |                         |

NOTE 1: OCBW is in Hz.

NOTE 2: In case of radiated measurements using a companion device and the level of the wanted signal from the companion device cannot be determined, a relative test may be performed using a wanted signal up to P<sub>min</sub> + 26 dB where P<sub>min</sub> is the minimum level of wanted signal required to meet the minimum performance criteria as defined in clause 4.3.1.12.3 in the absence of any blocking signal.

NOTE 3: In case of radiated measurements using a companion device and the level of the wanted signal from the companion device cannot be determined, a relative test may be performed using a wanted signal up to P<sub>min</sub> + 20 dB where P<sub>min</sub> is the minimum level of wanted signal required to meet the minimum performance criteria as defined in clause 4.3.1.12.3 in the absence of any blocking signal.

NOTE 4: The level specified is the level at the UUT receiver input assuming a 0 dBi antenna assembly gain. In case of conducted measurements, this level has to be corrected for the (in-band) antenna assembly gain (G). In case of radiated measurements, this level is equivalent to a power flux density (PFD) in front of the UUT antenna with the UUT being configured/positioned as recorded in clause 5.4.3.2.2.

**Table 15: Receiver Blocking parameters receiver category 2 equipment**

| Wanted signal mean power from companion device (dBm)<br>(see notes 1 and 3)                                  | Blocking signal<br>Frequency (MHz) | Blocking signal power<br>(dBm) (see note 3) | Type of blocking<br>signal |
|--|------------------------------------|---|----------------------------|
| (-139 dBm + 10 × log <sub>10</sub> (OCBW) + 10 dB)<br>or (-74 dBm + 10 dB) whichever is less<br>(see note 2) | 2 380                              | -34   | CW                         |
|  | 2 504                              |   |                            |
|  | 2 300                              |   |                            |
|  | 2 584                              |   |                            |

NOTE 1: OCBW is in Hz.

NOTE 2: In case of radiated measurements using a companion device and the level of the wanted signal from the companion device cannot be determined, a relative test may be performed using a wanted signal up to P<sub>min</sub> + 26 dB where P<sub>min</sub> is the minimum level of wanted signal required to meet the minimum performance criteria as defined in clause 4.3.1.12.3 in the absence of any blocking signal.

NOTE 3: The level specified is the level at the UUT receiver input assuming a 0 dBi antenna assembly gain. In case of conducted measurements, this level has to be corrected for the (in-band) antenna assembly gain (G). In case of radiated measurements, this level is equivalent to a power flux density (PFD) in front of the UUT antenna with the UUT being configured/positioned as recorded in clause 5.4.3.2.2.

**Table 16: Receiver Blocking parameters receiver category 3 equipment**

| Wanted signal mean power from companion device (dBm)   | Blocking signal<br>Frequency (MHz) | Blocking signal power<br>(dBm) (see note 2) | Type of blocking<br>signal |
|--|------------------------------------|---|----------------------------|
| (-139 dBm + 10 × log <sub>10</sub> (OCBW) + 20 dB)<br>or (-74 dBm + 20 dB) whichever is less<br>(see note 2) | 2 380                              | -34   | CW                         |
|  | 2 504                              |   |                            |
|  | 2 300                              |   |                            |
|  | 2 584                              |   |                            |

NOTE 1: OCBW is in Hz.

NOTE 2: In case of radiated measurements using a companion device and the level of the wanted signal from the companion device cannot be determined, a relative the test may be performed using a wanted signal up to P<sub>min</sub> + 30 dB where P<sub>min</sub> is the minimum level of wanted signal required to meet the minimum performance criteria as defined in clause 4.3.1.12.3 in the absence of any blocking signal.

NOTE 3: The level specified is the level at the UUT receiver input assuming a 0 dBi antenna assembly gain. In case of conducted measurements, this level has to be corrected for the (in-band) antenna assembly gain (G). In case of radiated measurements, this level is equivalent to a power flux density (PFD) in front of the UUT antenna with the UUT being configured/positioned as recorded in clause 5.4.3.2.2.

### 3.8.3 TEST PROCEDURE

Refer to chapter 5.4.11.2 of ETSI EN 300 328 V2.2.2 (2019-07)

| Measurement   |   |
|---|---|
| <input checked="" type="checkbox"/> Conducted measurement | <input type="checkbox"/> Radiated measurement |

3.8.4 DEVIATION FROM TEST STANDARD

No deviation

3.8.5 TEST SETUP

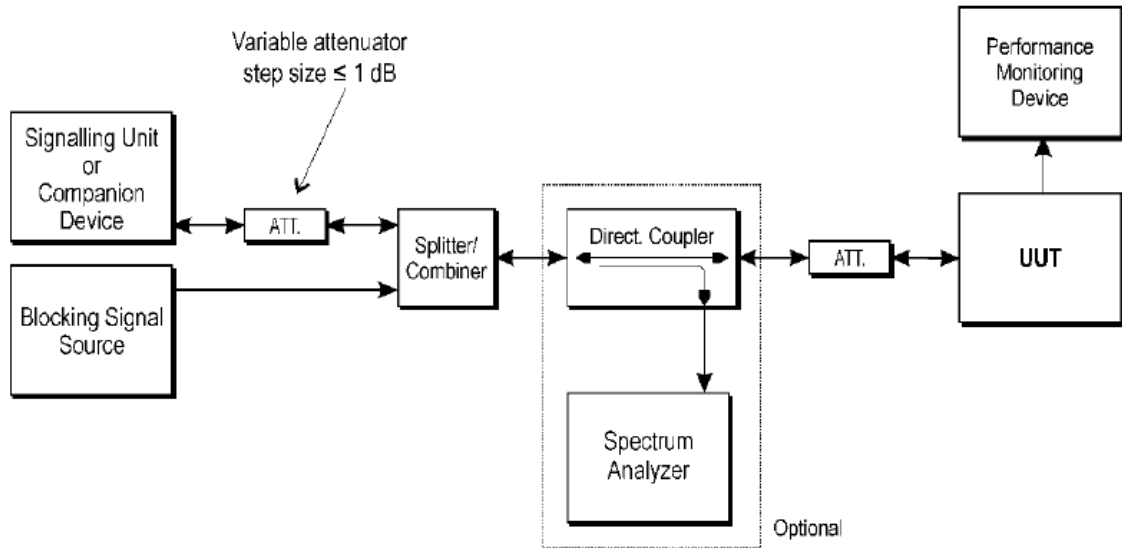

3.8.6 TEST RESULTS

|               |                            |                     |          |
|---------------|----------------------------|---------------------|----------|
| EUT :         | Smart phone                | Model Name :        | BV9300   |
| Temperature : | 26°C                       | Relative Humidity : | 60 %     |
| Pressure :    | 1012 hPa                   | Test Voltage :      | DC 3.85V |
| Test Mode :   | RX Mode(802.11b-CH01/CH13) |                     |          |

CH01:

receiver category 1

| Wanted signal mean power from companion device (dBm) <sup>Note(1)</sup> | Blocking signal Frequency (MHz) | Blocking signal power (dBm) | PER % | PER Limit % |
|---|---------------------------------|-----------------------------|-------|-------------|
| -68.6   | 2380                            | -34                         | 0.85% | ≤10%        |
|   | 2504                            |                             | 0.68% |             |
| -74.6   | 2300                            |                             | 0.47% | ≤10%        |
|   | 2330                            |                             | 0.33% |             |
|   | 2360                            |                             | 0.15% |             |
|   | 2524                            |                             | 0.89% |             |
|   | 2584                            |                             | 0.30% |             |
|   | 2674                            |                             | 0.60% |             |

CH13:

receiver category 1

| Wanted signal mean power from companion device (dBm) <sup>Note(1)</sup> | Blocking signal Frequency (MHz) | Blocking signal power (dBm) | PER % | PER Limit % |
|---|---------------------------------|-----------------------------|-------|-------------|
| -68.6   | 2380                            | -34                         | 0.20% | ≤10%        |
|   | 2504                            |                             | 0.15% |             |
| -74.6   | 2300                            |                             | 0.76% | ≤10%        |
|   | 2330                            |                             | 0.31% |             |
|   | 2360                            |                             | 0.23% |             |
|   | 2524                            |                             | 0.54% |             |
|   | 2584                            |                             | 0.89% |             |
|   | 2674                            |                             | 0.64% |             |

Note: (1) The above results were obtained from laboratory tests.

|               |                            |                     |          |
|---------------|----------------------------|---------------------|----------|
| EUT :         | Smart phone                | Model Name :        | BV9300   |
| Temperature : | 26°C                       | Relative Humidity : | 60 %     |
| Pressure :    | 1012 hPa                   | Test Voltage :      | DC 3.85V |
| Test Mode :   | RX Mode(802.11g-CH01/CH13) |                     |          |

CH01:

receiver category 1

| Wanted signal mean power from companion device (dBm) <sup>Note(1)</sup> | Blocking signal Frequency (MHz) | Blocking signal power (dBm) | PER % | PER Limit % |
|---|---------------------------------|-----------------------------|-------|-------------|
| -68.6   | 2380                            | -34                         | 0.87% | ≤10%        |
|   | 2504                            |                             | 0.37% |             |
| -74.6   | 2300                            |                             | 0.40% | ≤10%        |
|   | 2330                            |                             | 0.39% |             |
|   | 2360                            |                             | 0.99% |             |
|   | 2524                            |                             | 0.21% |             |
|   | 2584                            |                             | 0.43% |             |
|   | 2674                            |                             | 0.86% |             |

CH13:

receiver category 1

| Wanted signal mean power from companion device (dBm) <sup>Note(1)</sup> | Blocking signal Frequency (MHz) | Blocking signal power (dBm) | PER % | PER Limit % |
|---|---------------------------------|-----------------------------|-------|-------------|
| -68.6   | 2380                            | -34                         | 0.17% | ≤10%        |
|   | 2504                            |                             | 0.99% |             |
| -74.6   | 2300                            |                             | 0.18% | ≤10%        |
|   | 2330                            |                             | 0.82% |             |
|   | 2360                            |                             | 0.33% |             |
|   | 2524                            |                             | 0.04% |             |
|   | 2584                            |                             | 0.13% |             |
|   | 2674                            |                             | 0.80% |             |

Note: (1) The above results were obtained from laboratory tests.

|               |                              |                     |          |
|---------------|------------------------------|---------------------|----------|
| EUT :         | Smart phone                  | Model Name :        | BV9300   |
| Temperature : | 26°C                         | Relative Humidity : | 60 %     |
| Pressure :    | 1012 hPa                     | Test Voltage :      | DC 3.85V |
| Test Mode :   | RX Mode(802.11n20-CH01/CH13) |                     |          |

CH01:

**receiver category 1**

| Wanted signal mean power from companion device (dBm) <sup>Note(1)</sup> | Blocking signal Frequency (MHz) | Blocking signal power (dBm) | PER % | PER Limit % |
|---|---------------------------------|-----------------------------|-------|-------------|
| -68.6   | 2380                            | -34                         | 0.19% | ≤10%        |
|   | 2504                            |                             | 0.61% |             |
| -74.6   | 2300                            |                             | 0.55% | ≤10%        |
|   | 2330                            |                             | 0.66% |             |
|   | 2360                            |                             | 0.00% |             |
|   | 2524                            |                             | 0.17% |             |
|   | 2584                            |                             | 0.89% |             |
|   | 2674                            |                             | 0.46% |             |

CH13:

**receiver category 1**

| Wanted signal mean power from companion device (dBm) <sup>Note(1)</sup> | Blocking signal Frequency (MHz) | Blocking signal power (dBm) | PER % | PER Limit % |
|---|---------------------------------|-----------------------------|-------|-------------|
| -68.6   | 2380                            | -34                         | 0.74% | ≤10%        |
|   | 2504                            |                             | 0.08% |             |
| -74.6   | 2300                            |                             | 0.10% | ≤10%        |
|   | 2330                            |                             | 0.44% |             |
|   | 2360                            |                             | 0.93% |             |
|   | 2524                            |                             | 0.71% |             |
|   | 2584                            |                             | 0.66% |             |
|   | 2674                            |                             | 0.25% |             |

Note: (1) The above results were obtained from laboratory tests.



|               |                              |                     |          |
|---------------|------------------------------|---------------------|----------|
| EUT :         | Smart phone                  | Model Name :        | BV9300   |
| Temperature : | 26°C                         | Relative Humidity : | 60 %     |
| Pressure :    | 1012 hPa                     | Test Voltage :      | DC 3.85V |
| Test Mode :   | RX Mode(802.11n40-CH03/CH11) |                     |          |

CH03:

receiver category 1

| Wanted signal mean power from companion device (dBm) <sup>Note(1)</sup> | Blocking signal Frequency (MHz) | Blocking signal power (dBm) | PER % | PER Limit % |
|---|---------------------------------|-----------------------------|-------|-------------|
| -68.6   | 2380                            | -34                         | 0.97% | ≤10%        |
|   | 2504                            |                             | 0.16% |             |
| -74.6   | 2300                            |                             | 0.40% | ≤10%        |
|   | 2330                            |                             | 0.64% |             |
|   | 2360                            |                             | 0.31% |             |
|   | 2524                            |                             | 0.43% |             |
|   | 2584                            |                             | 0.58% |             |
|   | 2674                            |                             | 0.10% |             |

CH11:

receiver category 1

| Wanted signal mean power from companion device (dBm) <sup>Note(1)</sup> | Blocking signal Frequency (MHz) | Blocking signal power (dBm) | PER % | PER Limit % |
|---|---------------------------------|-----------------------------|-------|-------------|
| -68.6   | 2380                            | -34                         | 0.68% | ≤10%        |
|   | 2504                            |                             | 0.62% |             |
| -74.6   | 2300                            |                             | 0.37% | ≤10%        |
|   | 2330                            |                             | 0.02% |             |
|   | 2360                            |                             | 0.10% |             |
|   | 2524                            |                             | 0.18% |             |
|   | 2584                            |                             | 0.83% |             |
|   | 2674                            |                             | 0.66% |             |

Note: (1) The above results were obtained from laboratory tests.



## 4. TEST RESULTS

### 4.1 RF Output Power

| Condition | Mode | Frequency (MHz) | Antenna | Max Burst RMS Power (dBm) | Burst Number | Max EIRP (dBm) | Limit (dBm) | Verdict |
|-----------|------|-----------------|---------|---------------------------|--------------|----------------|-------------|---------|
| NVNT      | b    | 2412            | Ant1    | 16.51                     | 49           | 15.91          | 20          | Pass    |
| NVNT      | b    | 2442            | Ant1    | 16.64                     | 49           | 16.04          | 20          | Pass    |
| NVNT      | b    | 2472            | Ant1    | 16.25                     | 49           | 15.65          | 20          | Pass    |
| NVNT      | g    | 2412            | Ant1    | 13.67                     | 281          | 13.07          | 20          | Pass    |
| NVNT      | g    | 2442            | Ant1    | 13.54                     | 281          | 12.94          | 20          | Pass    |
| NVNT      | g    | 2472            | Ant1    | 13.66                     | 281          | 13.06          | 20          | Pass    |
| NVNT      | n20  | 2412            | Ant1    | 11.72                     | 225          | 11.12          | 20          | Pass    |
| NVNT      | n20  | 2442            | Ant1    | 11.87                     | 226          | 11.27          | 20          | Pass    |
| NVNT      | n20  | 2472            | Ant1    | 11.79                     | 226          | 11.19          | 20          | Pass    |
| NVNT      | n40  | 2422            | Ant1    | 11.06                     | 440          | 10.46          | 20          | Pass    |
| NVNT      | n40  | 2442            | Ant1    | 11.14                     | 440          | 10.54          | 20          | Pass    |
| NVNT      | n40  | 2462            | Ant1    | 11.2                      | 441          | 10.60          | 20          | Pass    |
| NVLT      | b    | 2412            | Ant1    | 16.16                     | 49           | 15.56          | 20          | Pass    |
| NVLT      | b    | 2442            | Ant1    | 16.32                     | 49           | 15.72          | 20          | Pass    |
| NVLT      | b    | 2472            | Ant1    | 15.94                     | 49           | 15.34          | 20          | Pass    |
| NVLT      | g    | 2412            | Ant1    | 13.11                     | 281          | 12.51          | 20          | Pass    |
| NVLT      | g    | 2442            | Ant1    | 13.28                     | 281          | 12.68          | 20          | Pass    |
| NVLT      | g    | 2472            | Ant1    | 12.97                     | 281          | 12.37          | 20          | Pass    |
| NVLT      | n20  | 2412            | Ant1    | 11.61                     | 225          | 11.01          | 20          | Pass    |
| NVLT      | n20  | 2442            | Ant1    | 11.18                     | 226          | 10.58          | 20          | Pass    |
| NVLT      | n20  | 2472            | Ant1    | 11.16                     | 226          | 10.56          | 20          | Pass    |
| NVLT      | n40  | 2422            | Ant1    | 9.76                      | 440          | 9.16           | 20          | Pass    |
| NVLT      | n40  | 2442            | Ant1    | 9.9                       | 440          | 9.30           | 20          | Pass    |
| NVLT      | n40  | 2462            | Ant1    | 9.94                      | 441          | 9.34           | 20          | Pass    |
| NVHT      | b    | 2412            | Ant1    | 16.21                     | 49           | 15.61          | 20          | Pass    |
| NVHT      | b    | 2442            | Ant1    | 16.06                     | 49           | 15.46          | 20          | Pass    |
| NVHT      | b    | 2472            | Ant1    | 16.15                     | 49           | 15.55          | 20          | Pass    |
| NVHT      | g    | 2412            | Ant1    | 13.27                     | 281          | 12.67          | 20          | Pass    |
| NVHT      | g    | 2442            | Ant1    | 13.02                     | 281          | 12.42          | 20          | Pass    |
| NVHT      | g    | 2472            | Ant1    | 13.1                      | 281          | 12.50          | 20          | Pass    |
| NVHT      | n20  | 2412            | Ant1    | 10.92                     | 225          | 10.32          | 20          | Pass    |
| NVHT      | n20  | 2442            | Ant1    | 11.37                     | 226          | 10.77          | 20          | Pass    |
| NVHT      | n20  | 2472            | Ant1    | 11.67                     | 226          | 11.07          | 20          | Pass    |
| NVHT      | n40  | 2422            | Ant1    | 9.76                      | 440          | 9.16           | 20          | Pass    |
| NVHT      | n40  | 2442            | Ant1    | 9.9                       | 440          | 9.30           | 20          | Pass    |
| NVHT      | n40  | 2462            | Ant1    | 9.94                      | 441          | 9.34           | 20          | Pass    |

Test Graphs  
Power NVNT b 2412MHz Ant1

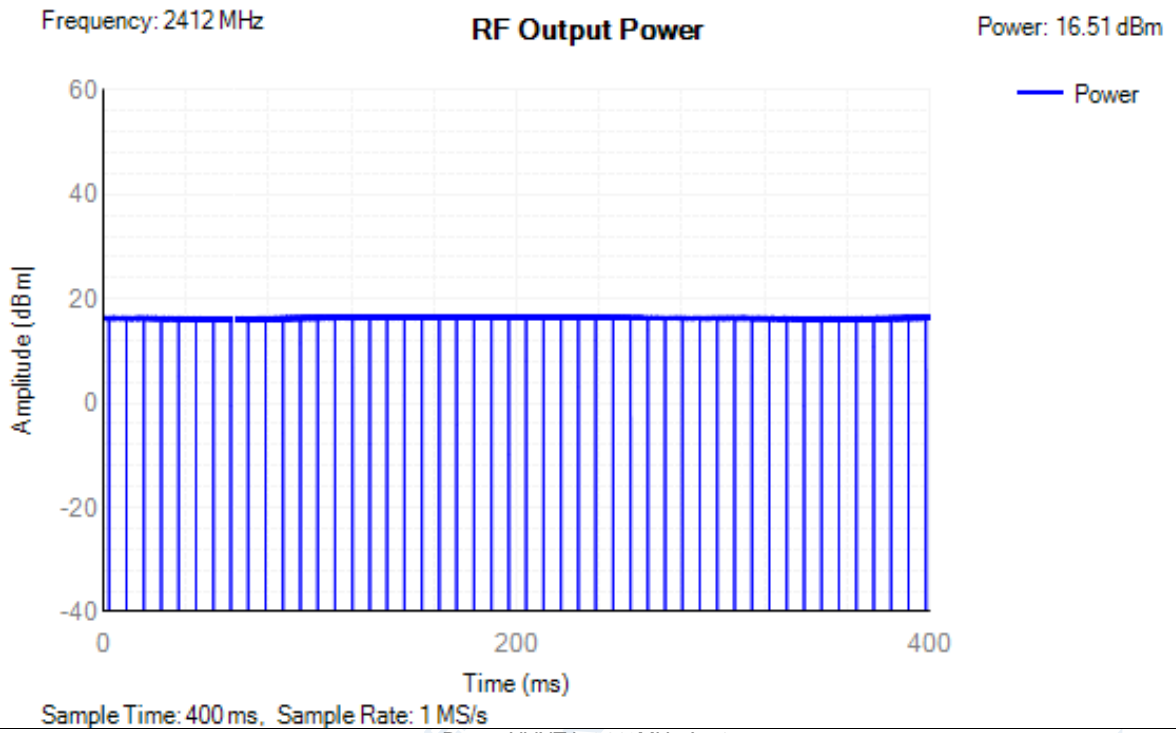

Power NVNT b 2442MHz Ant1

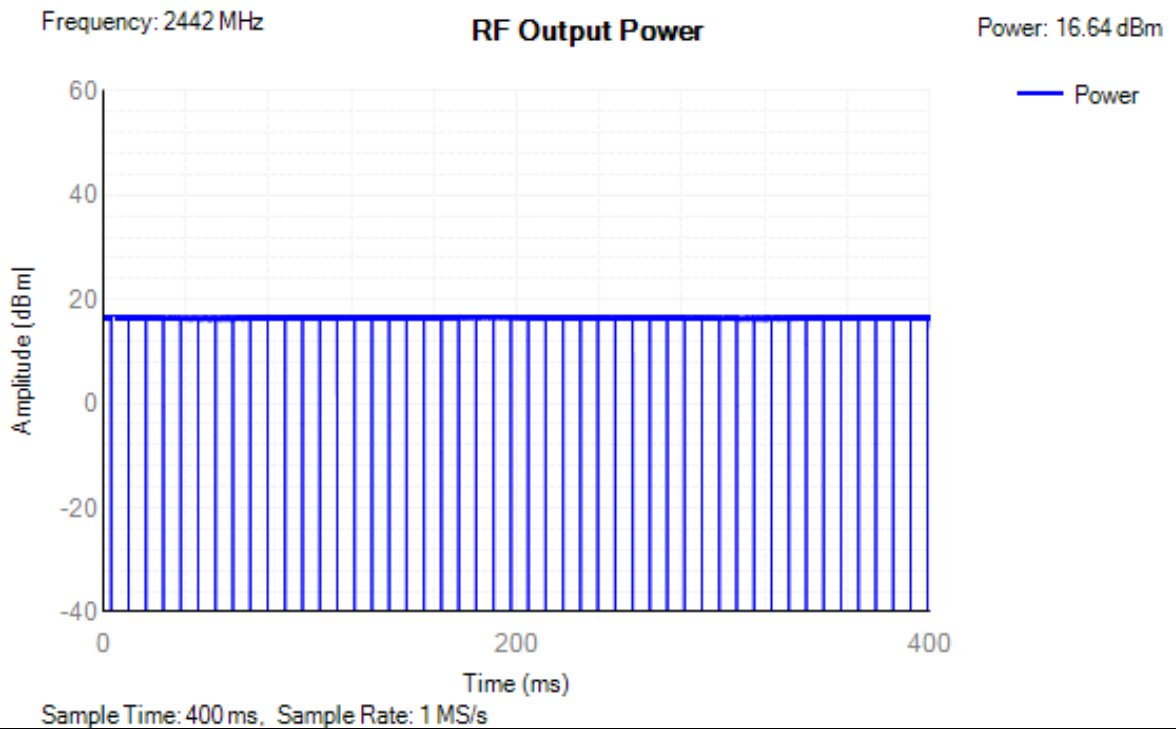

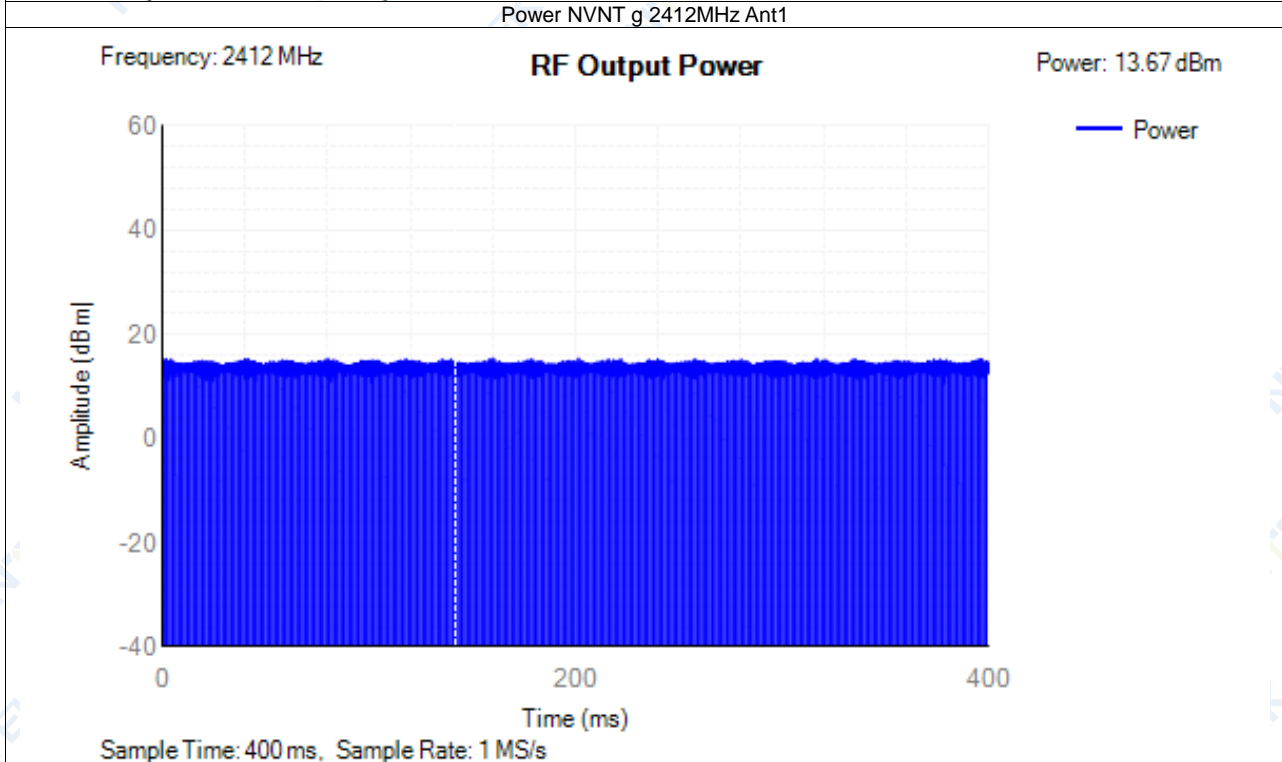
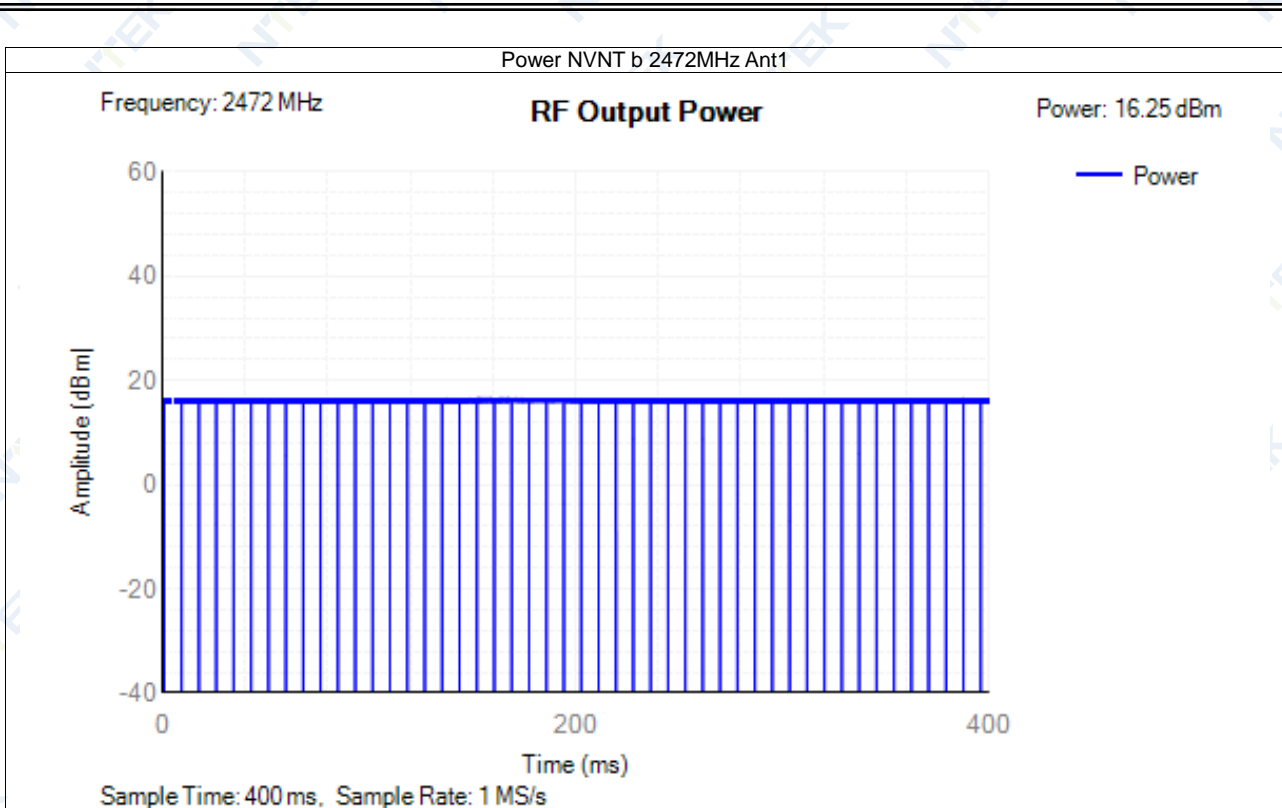

Power NVNT g 2442MHz Ant1

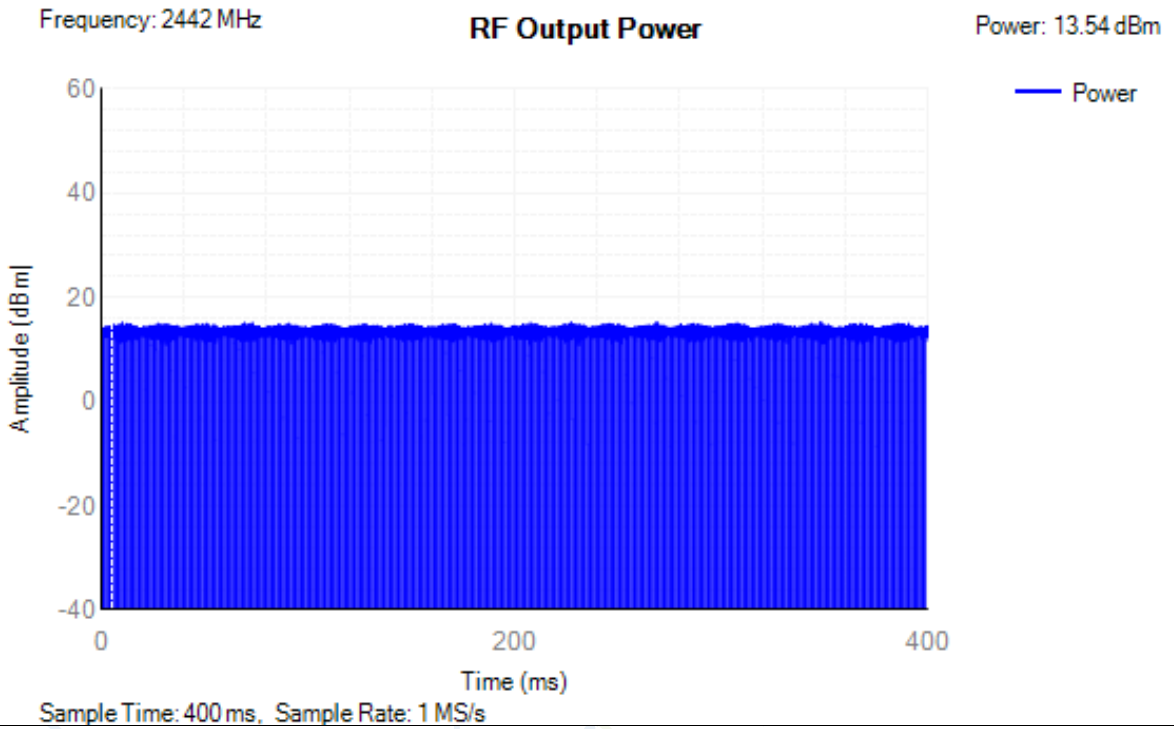

Power NVNT g 2472MHz Ant1

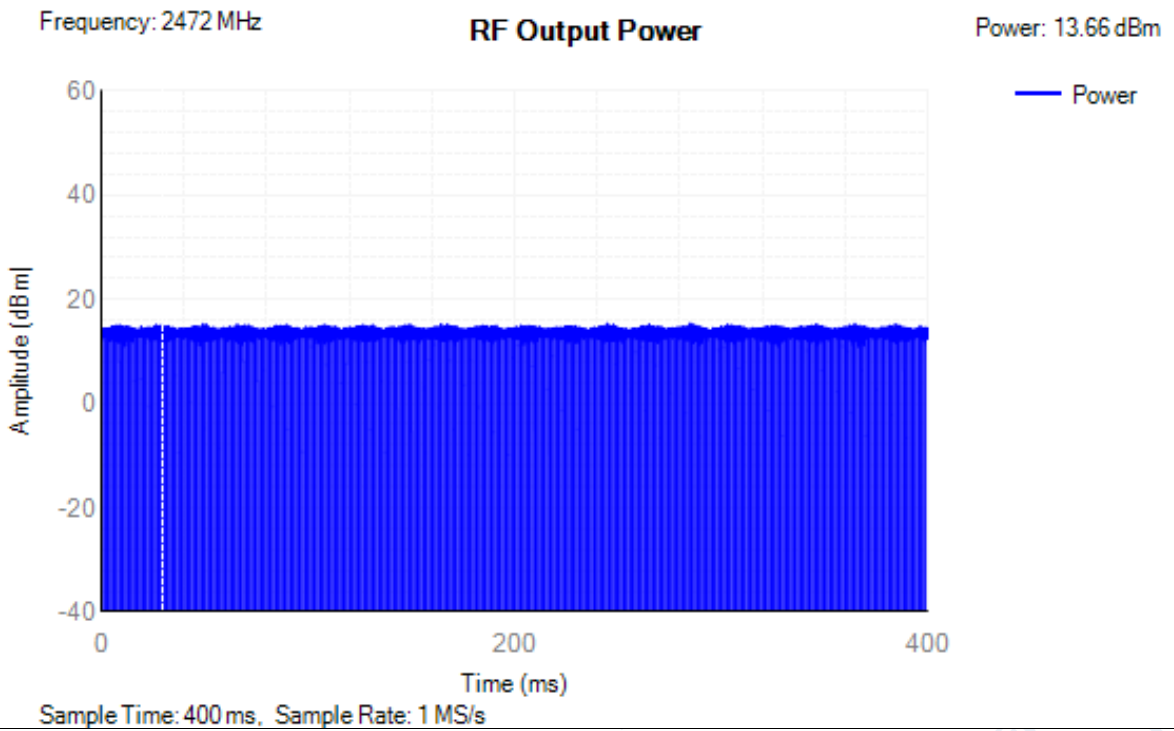

Power NVNT n20 2412MHz Ant1

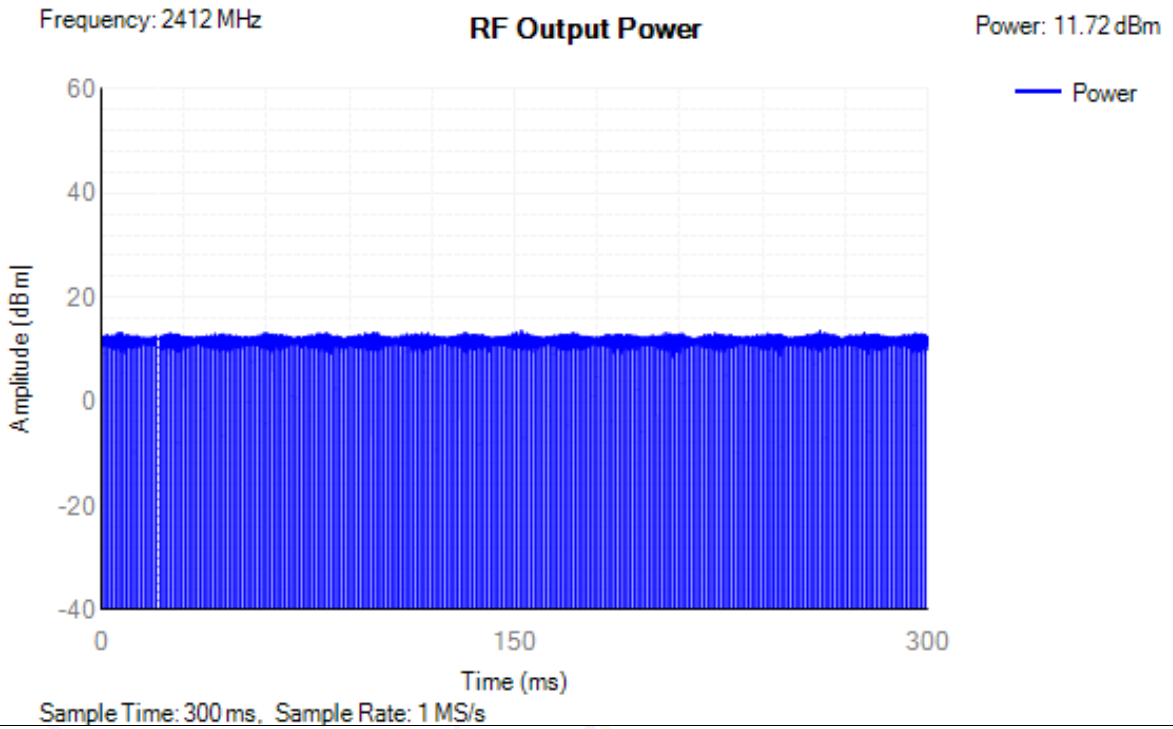

Power NVNT n20 2442MHz Ant1

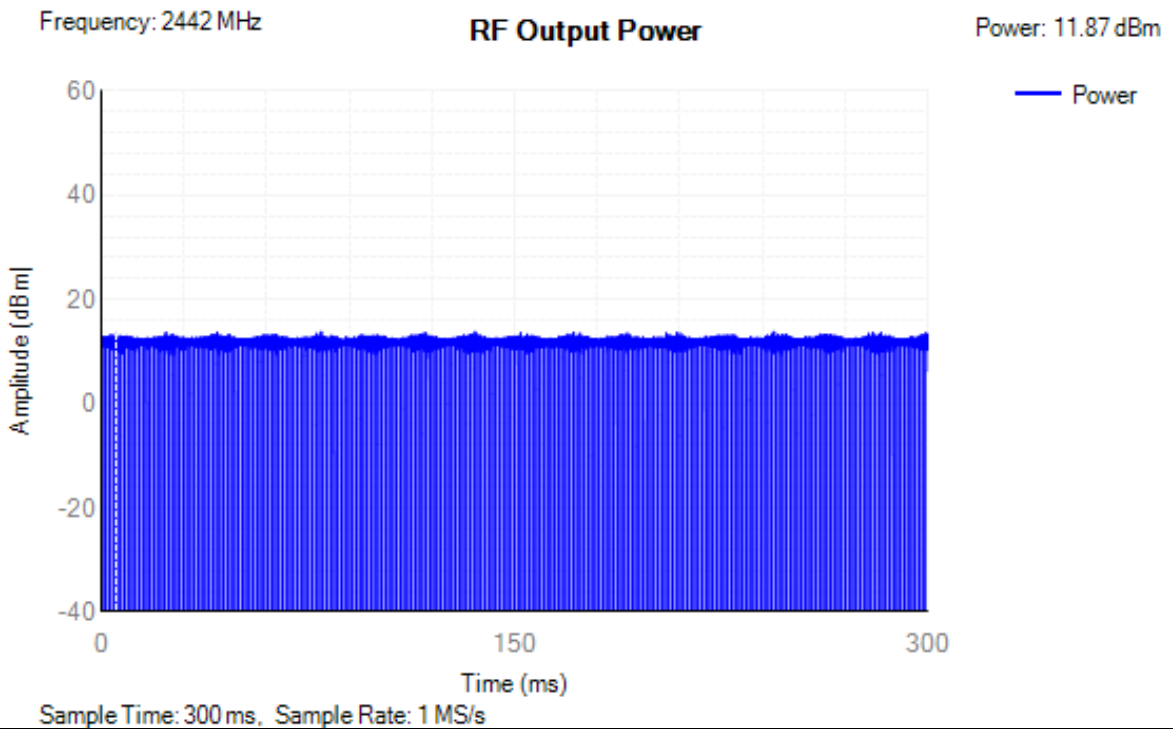

Power NVNT n20 2472MHz Ant1

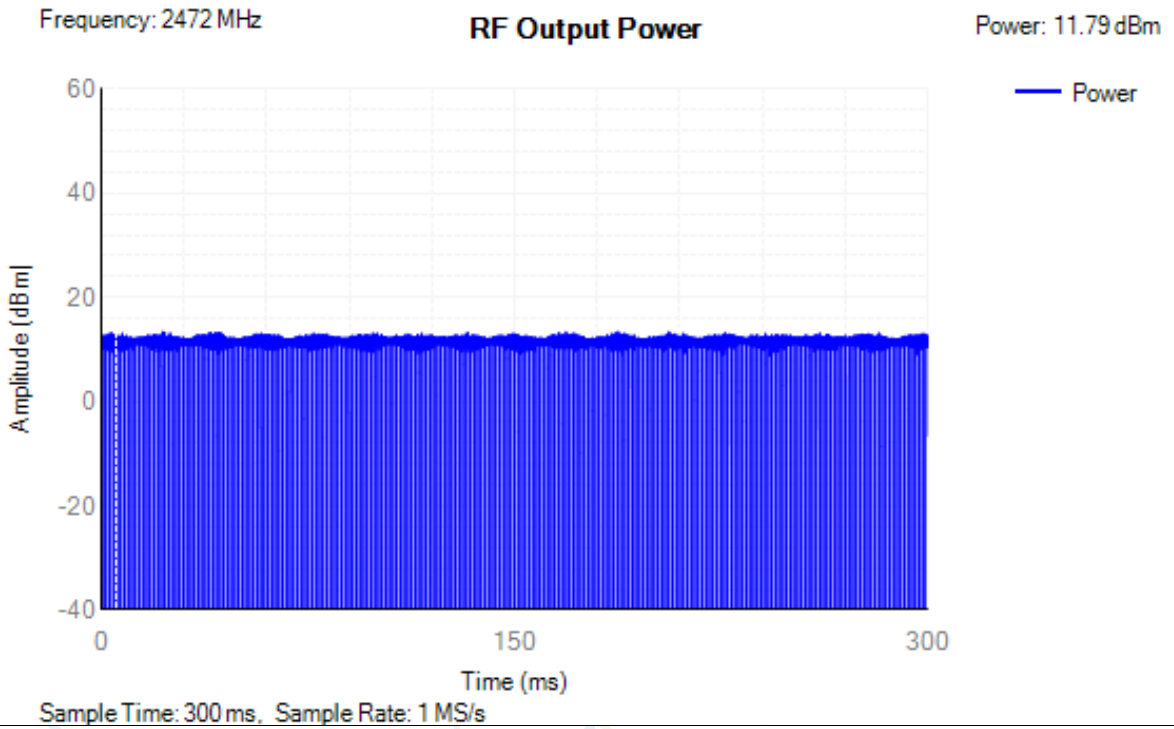

Power NVNT n40 2422MHz Ant1

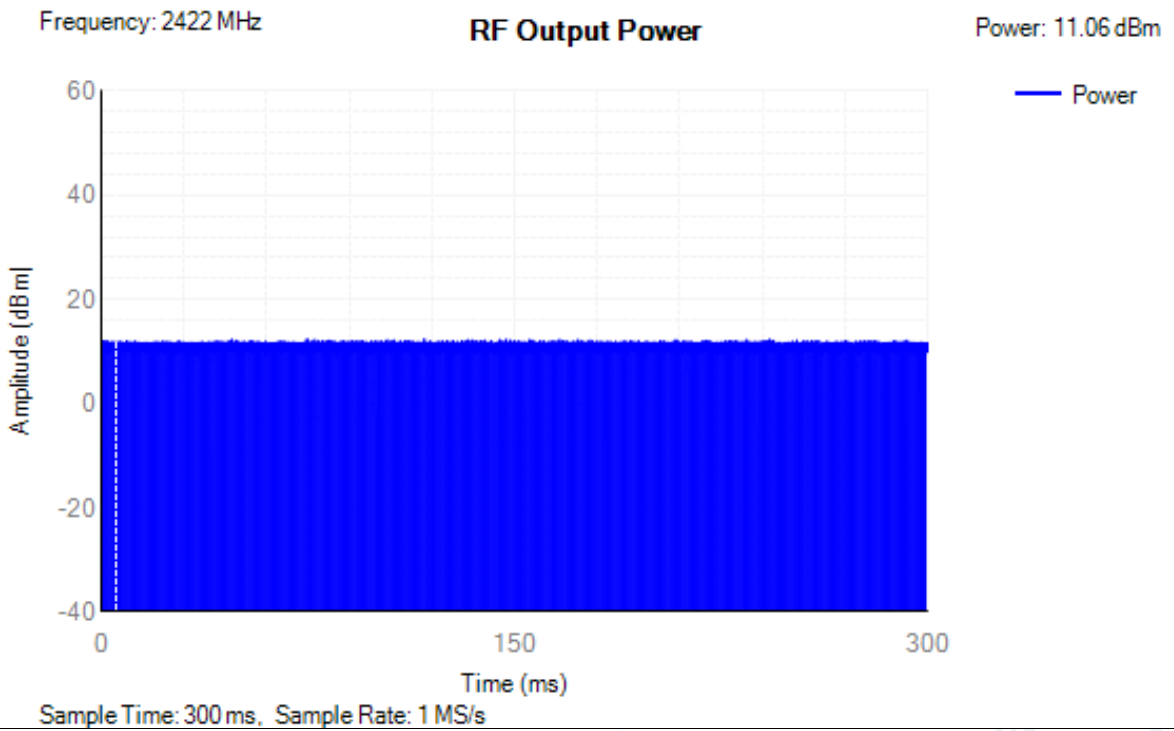

Power NVNT n40 2442MHz Ant1

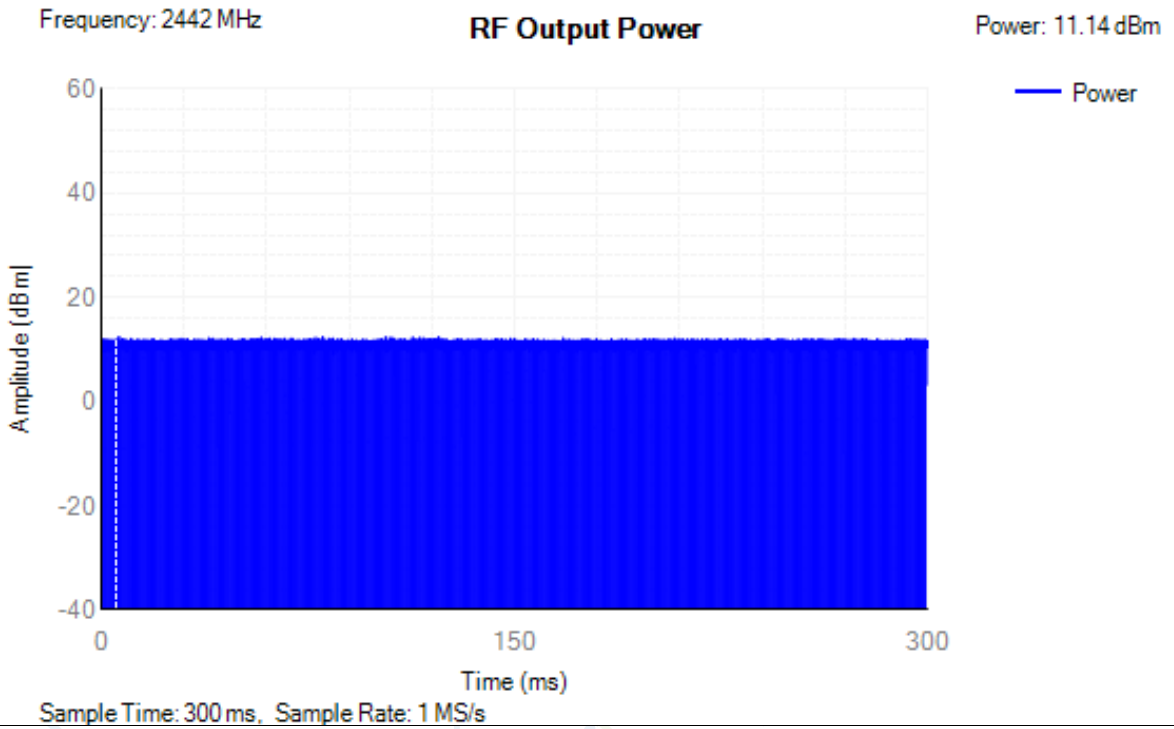

Power NVNT n40 2462MHz Ant1

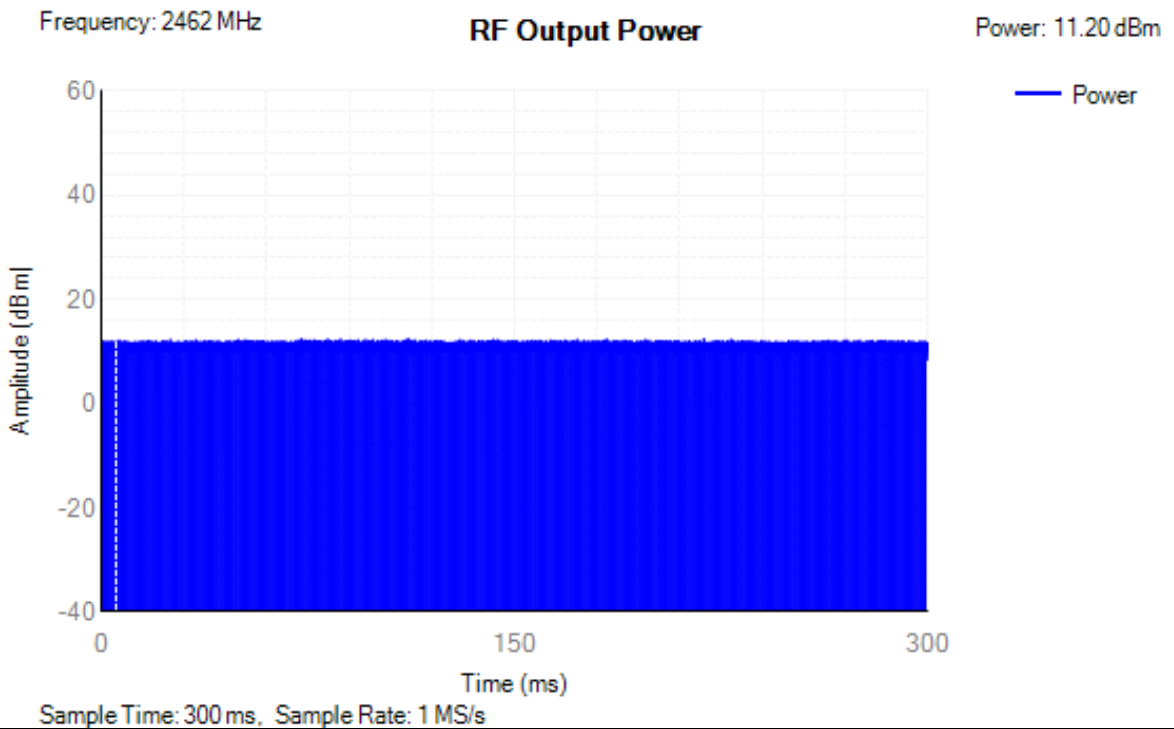



**4.2 Power Spectral Density**

| Condition | Mode | Frequency (MHz) | Antenna | Max PSD (dBm/MHz) | Limit (dBm/MHz) | Verdict |
|-----------|------|-----------------|---------|-------------------|-----------------|---------|
| NVNT      | b    | 2412            | Ant1    | 8.02              | 10              | Pass    |
| NVNT      | b    | 2442            | Ant1    | 8.04              | 10              | Pass    |
| NVNT      | b    | 2472            | Ant1    | 7.71              | 10              | Pass    |
| NVNT      | g    | 2412            | Ant1    | 2.45              | 10              | Pass    |
| NVNT      | g    | 2442            | Ant1    | 2.16              | 10              | Pass    |
| NVNT      | g    | 2472            | Ant1    | 2.34              | 10              | Pass    |
| NVNT      | n20  | 2412            | Ant1    | 0.28              | 10              | Pass    |
| NVNT      | n20  | 2442            | Ant1    | 0.34              | 10              | Pass    |
| NVNT      | n20  | 2472            | Ant1    | 0.24              | 10              | Pass    |
| NVNT      | n40  | 2422            | Ant1    | -3.32             | 10              | Pass    |
| NVNT      | n40  | 2442            | Ant1    | -3.52             | 10              | Pass    |
| NVNT      | n40  | 2462            | Ant1    | -3.1              | 10              | Pass    |

Test Graphs  
PSD NVNT b 2412MHz Ant1

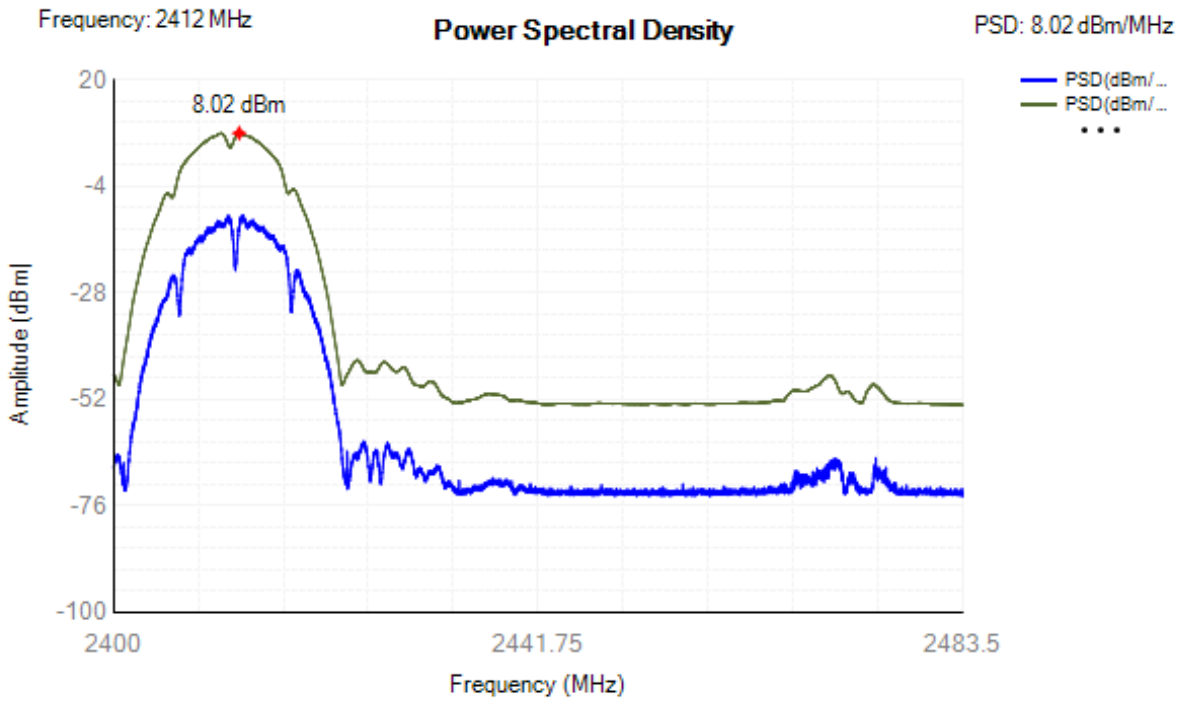

PSD NVNT b 2442MHz Ant1

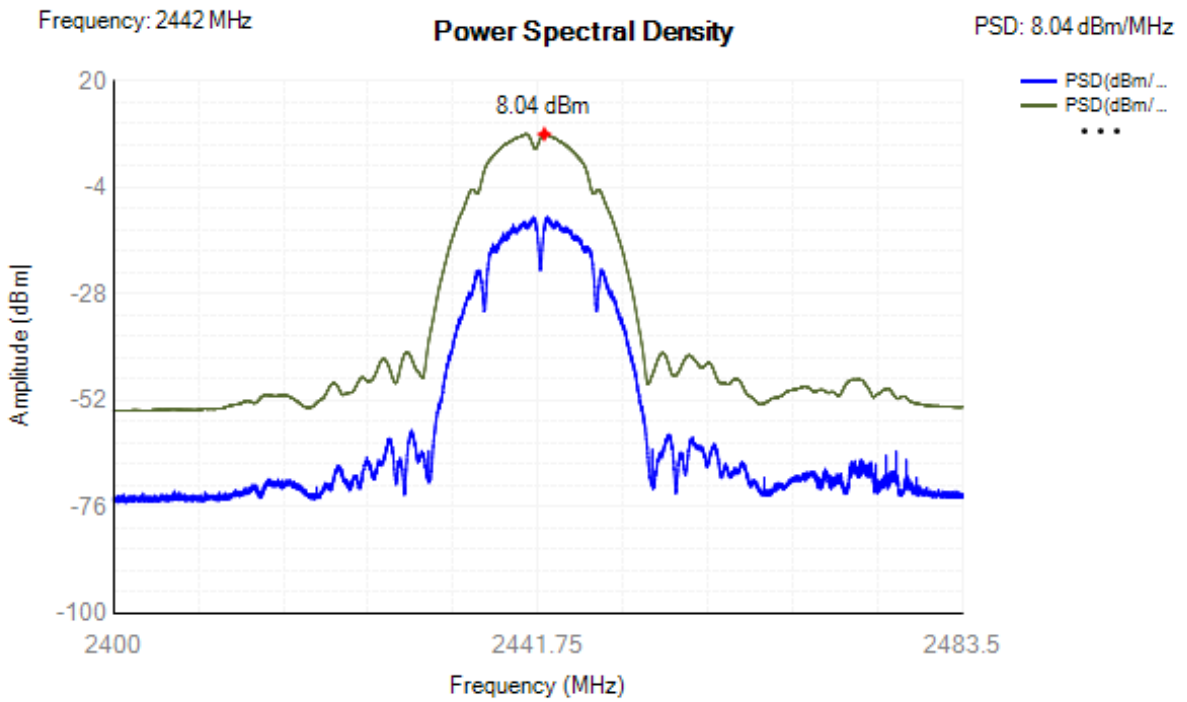

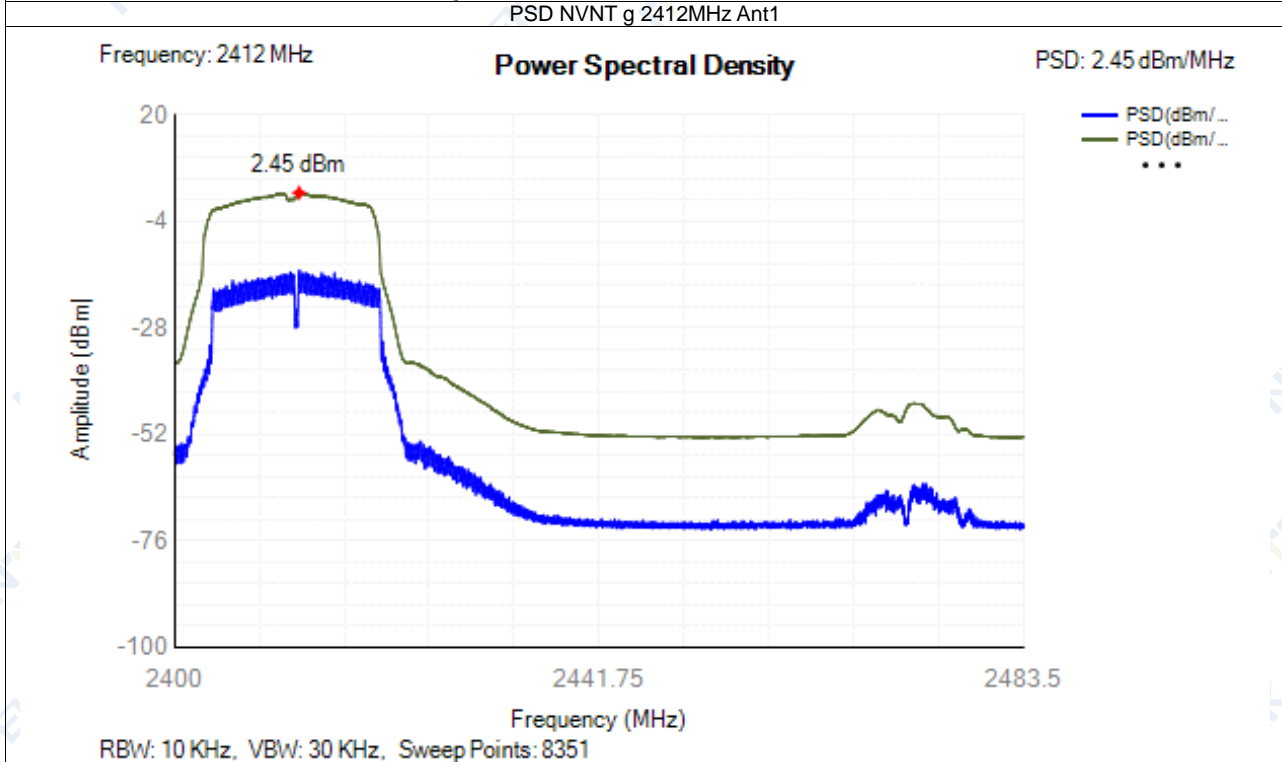
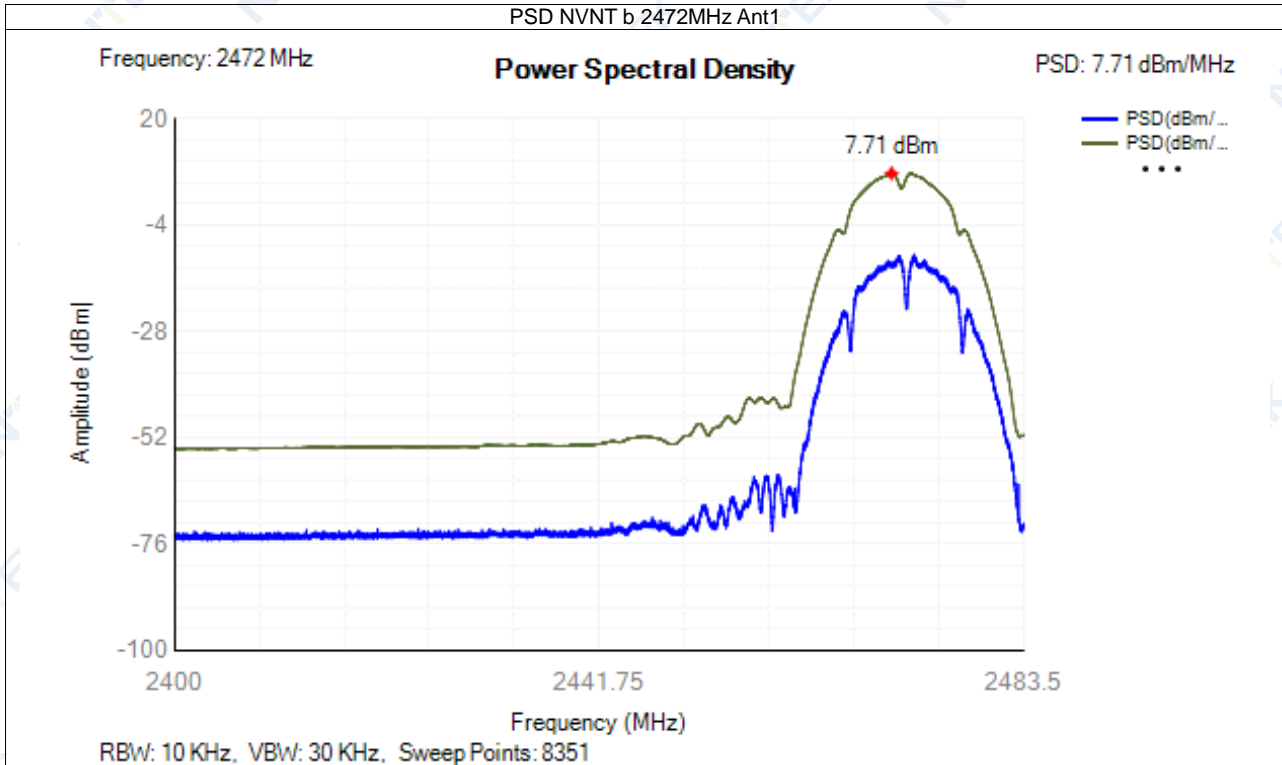

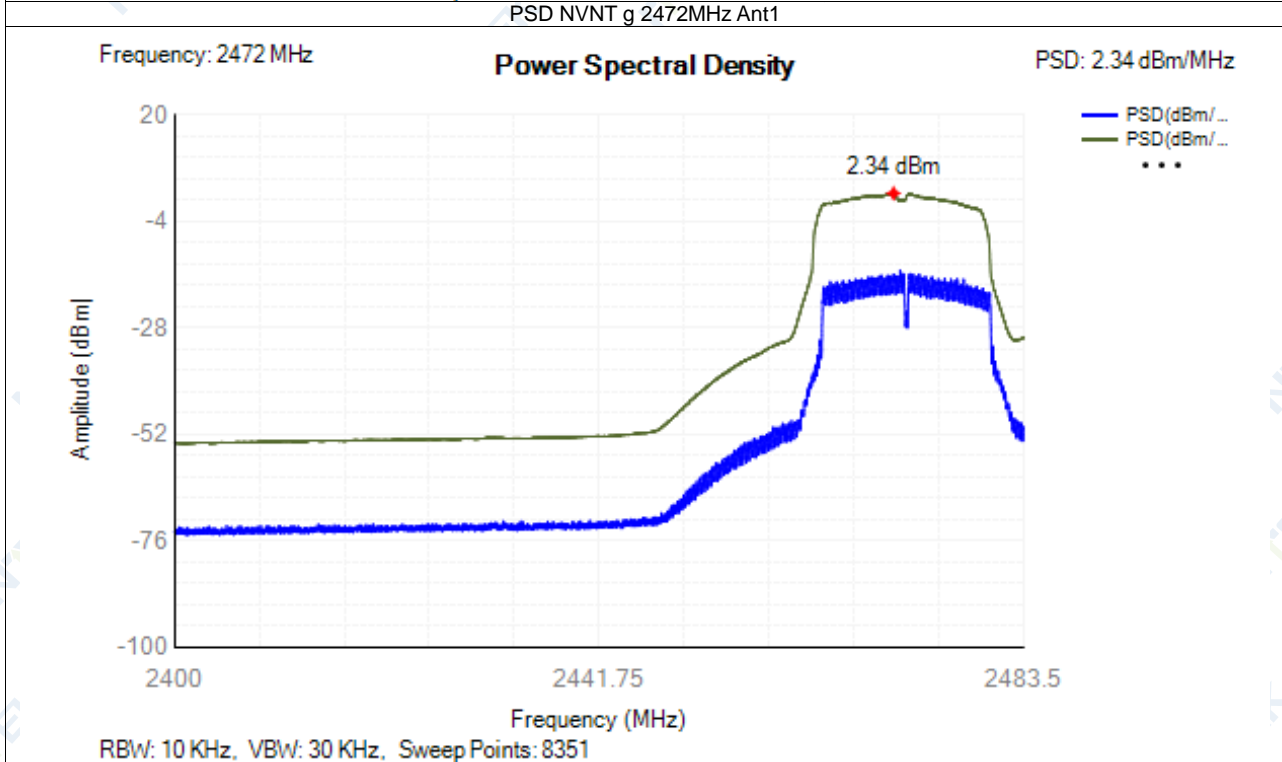
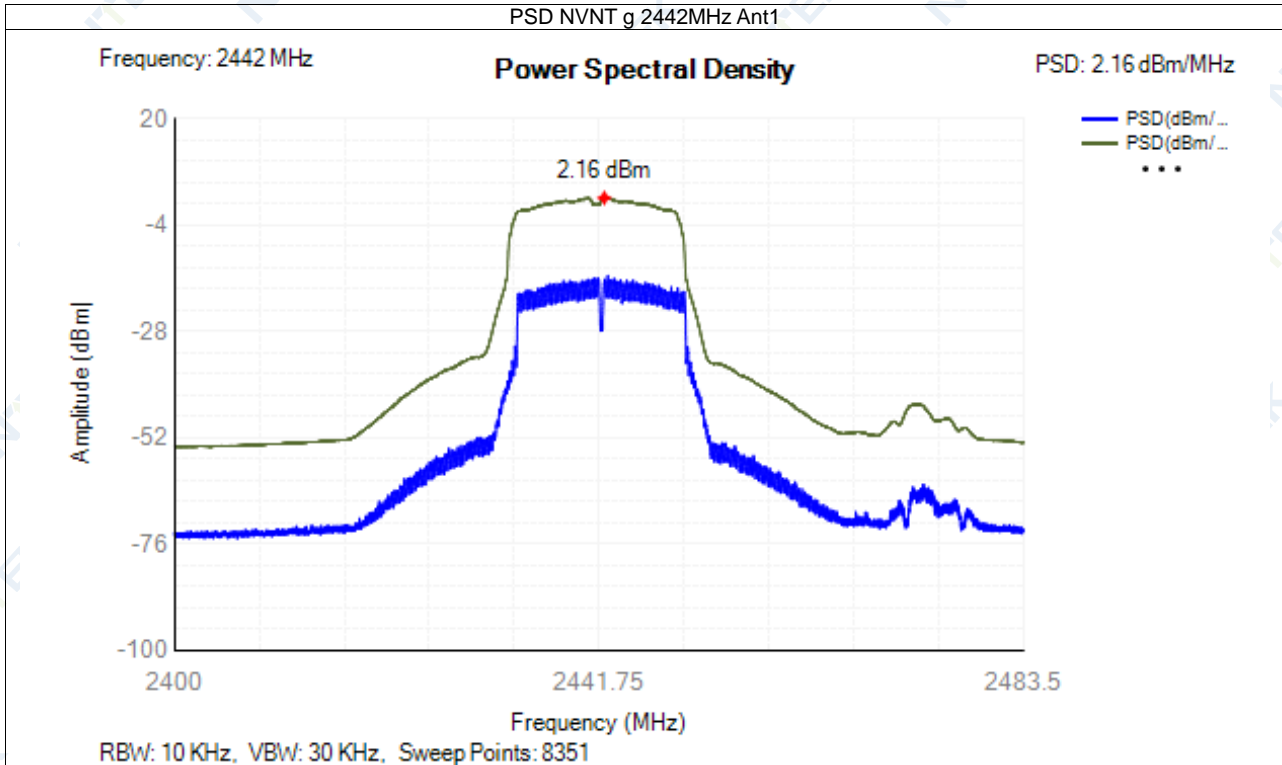

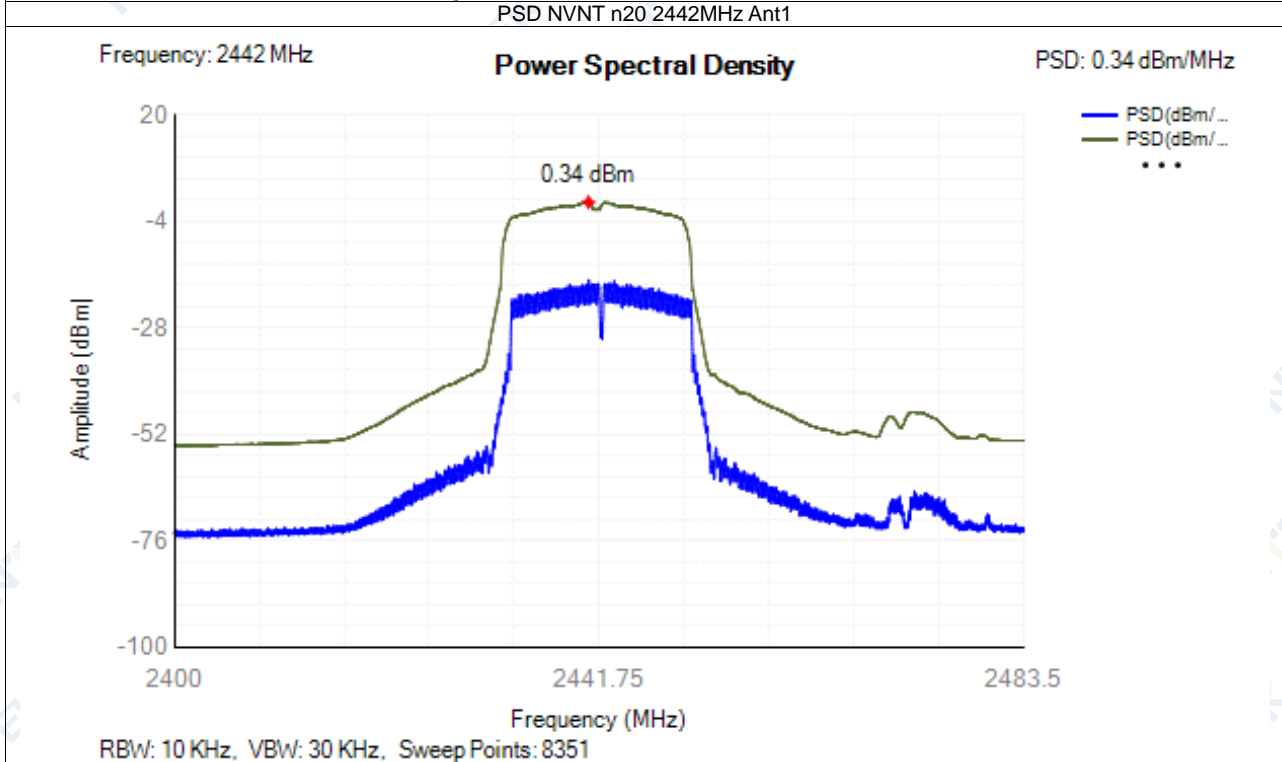
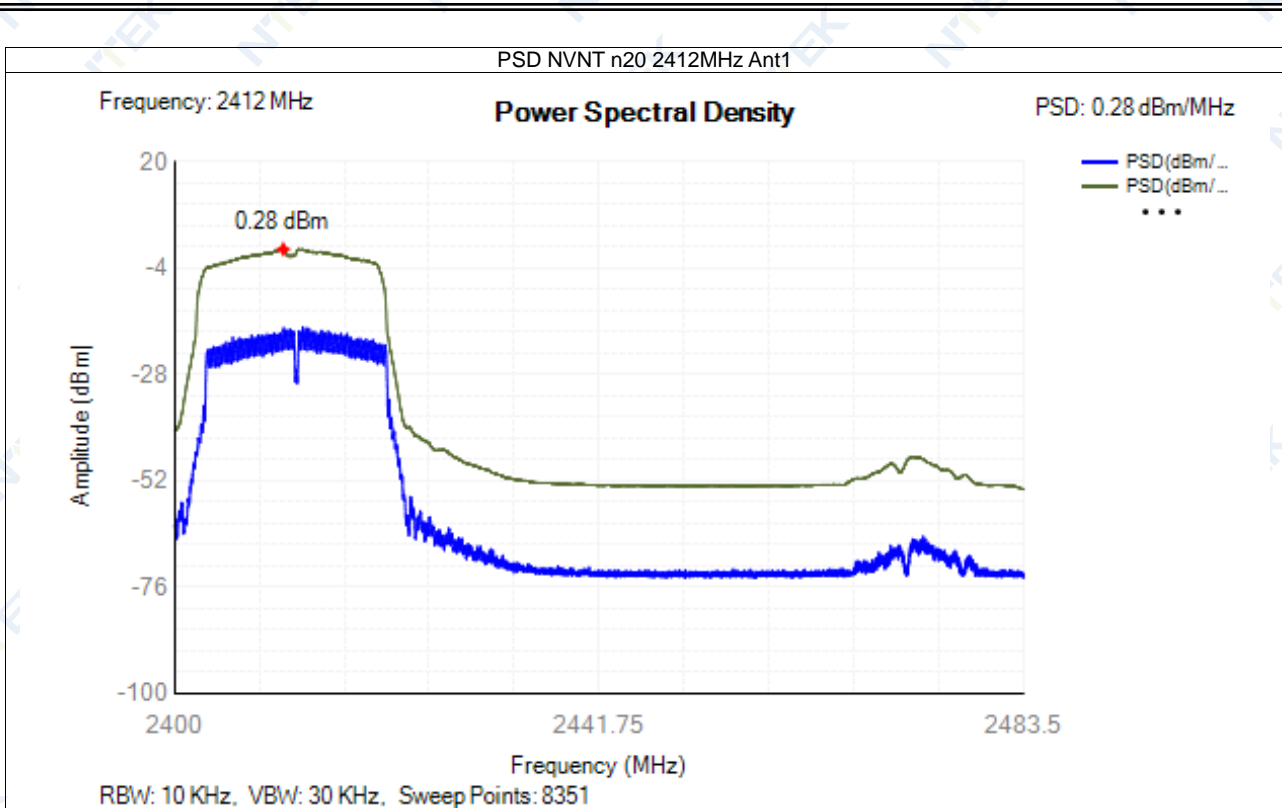

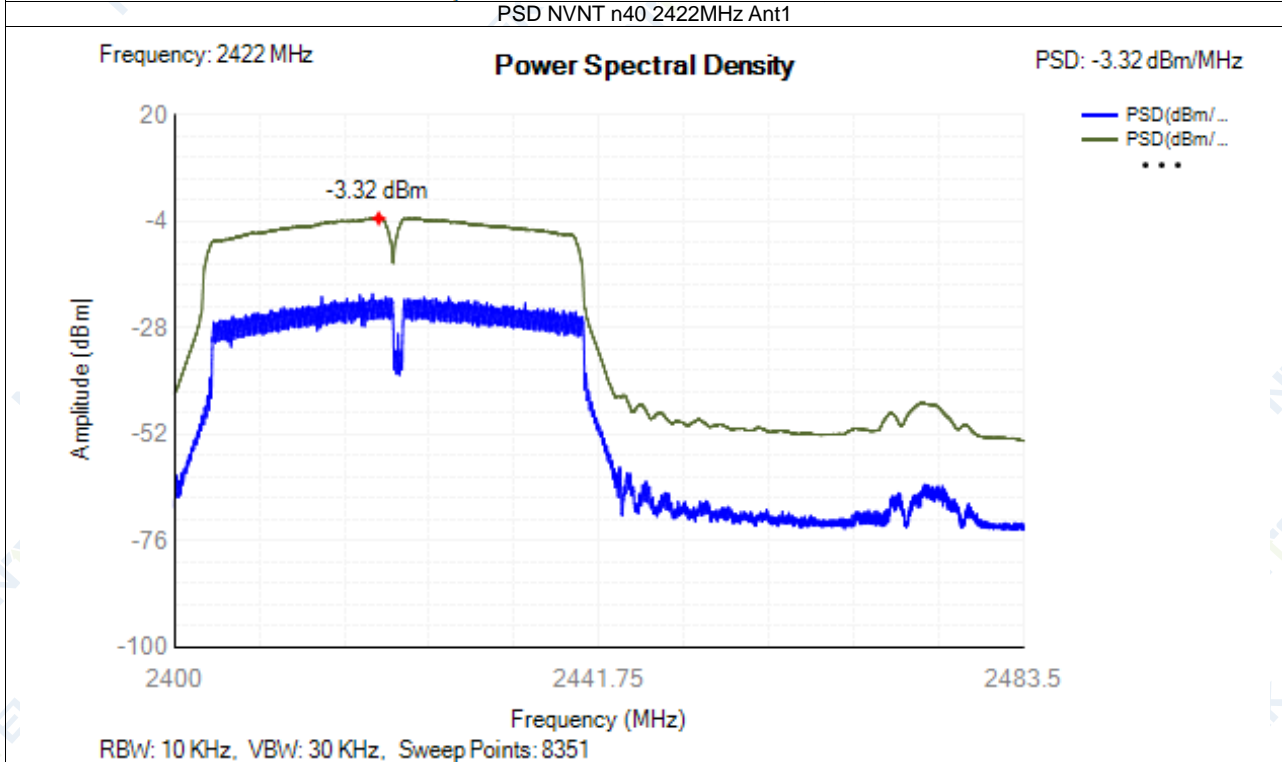
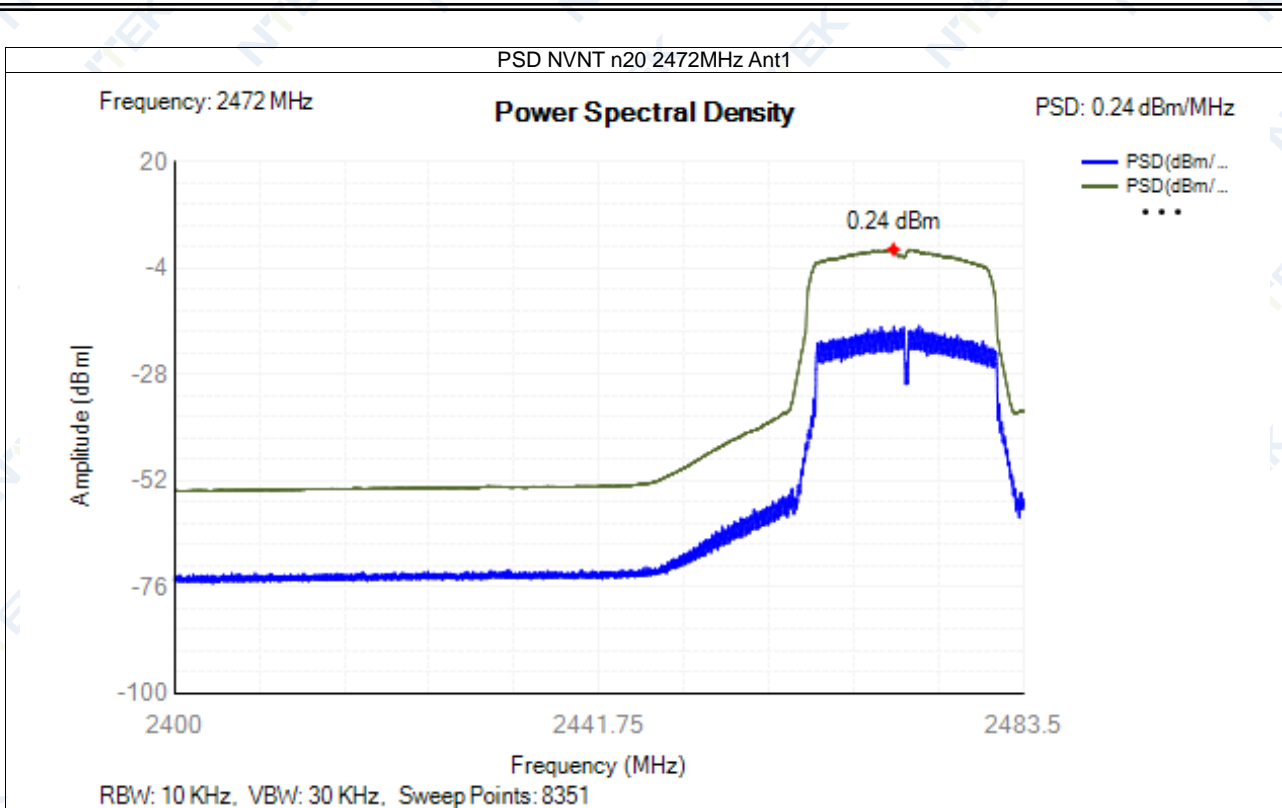

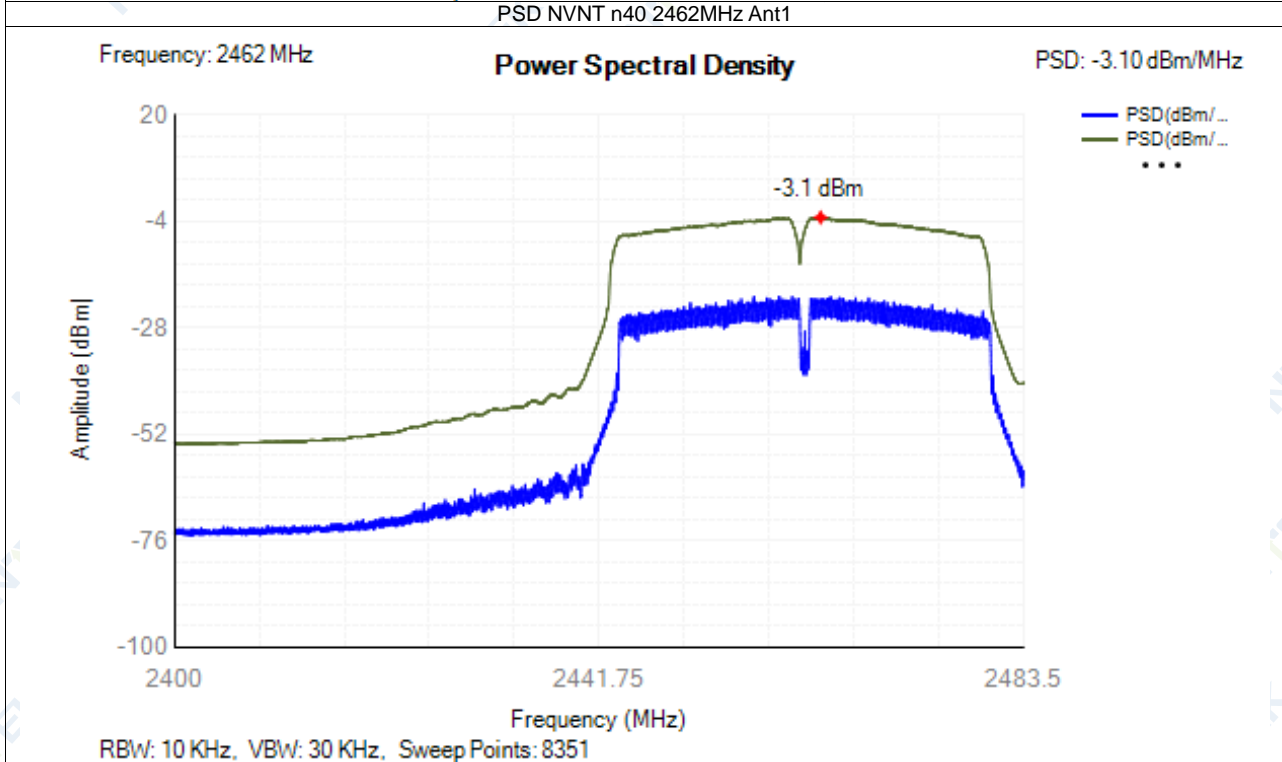
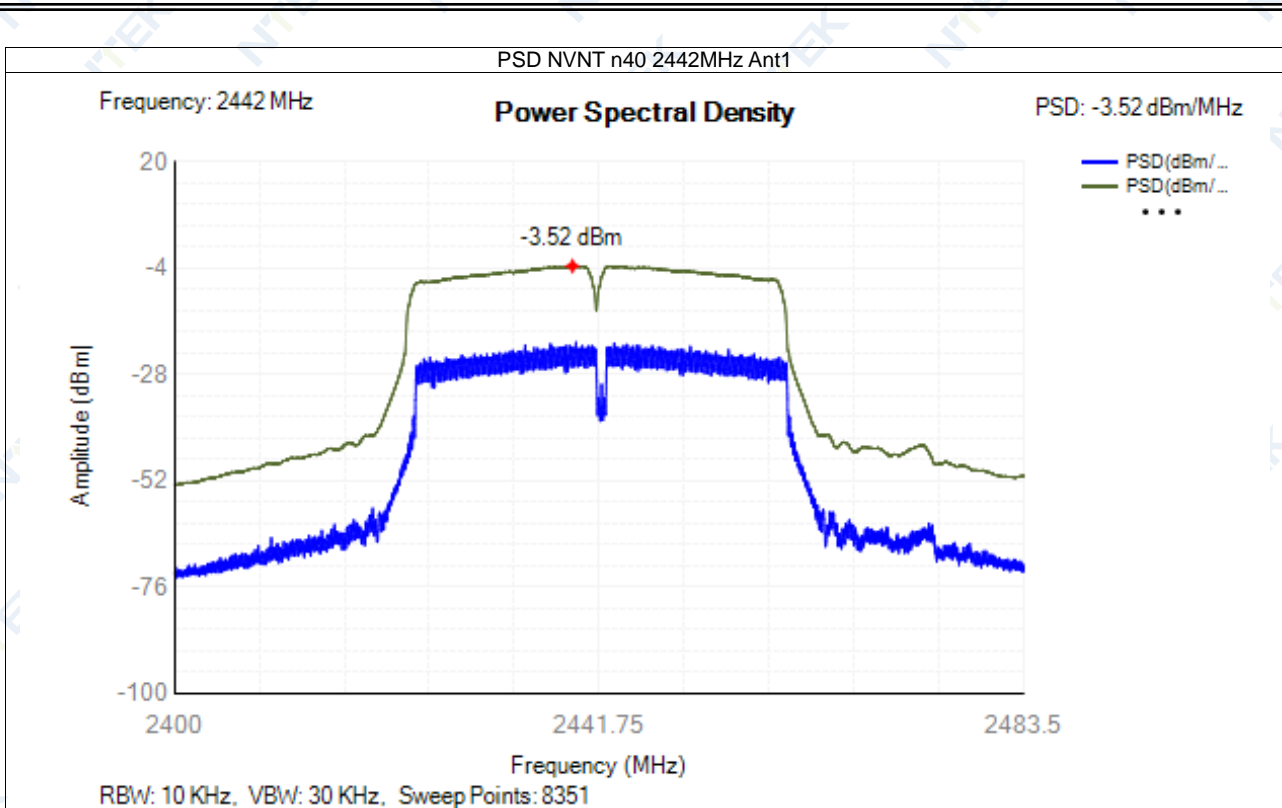



### 4.3 Occupied Channel Bandwidth

| Condition | Mode | Frequency (MHz) | Antenna | Center Frequency (MHz) | OBW (MHz) | Lower Edge (MHz) | Upper Edge (MHz) | Limit OBW (MHz)  | Verdict |
|-----------|------|-----------------|---------|------------------------|-----------|------------------|------------------|------------------|---------|
| NVNT      | b    | 2412            | Ant1    | 2412.068               | 12.831    | 2405.653         | 2418.483         | 2400 - 2483.5MHz | Pass    |
| NVNT      | b    | 2442            | Ant1    | 2441.992               | 13.015    | 2435.485         | 2448.499         | 2400 - 2483.5MHz | Pass    |
| NVNT      | b    | 2472            | Ant1    | 2471.964               | 12.935    | 2465.497         | 2478.431         | 2400 - 2483.5MHz | Pass    |
| NVNT      | g    | 2412            | Ant1    | 2412.006               | 16.498    | 2403.757         | 2420.255         | 2400 - 2483.5MHz | Pass    |
| NVNT      | g    | 2442            | Ant1    | 2441.982               | 16.53     | 2433.717         | 2450.247         | 2400 - 2483.5MHz | Pass    |
| NVNT      | g    | 2472            | Ant1    | 2471.95                | 16.53     | 2463.685         | 2480.215         | 2400 - 2483.5MHz | Pass    |
| NVNT      | n20  | 2412            | Ant1    | 2412.014               | 17.674    | 2403.177         | 2420.851         | 2400 - 2483.5MHz | Pass    |
| NVNT      | n20  | 2442            | Ant1    | 2441.984               | 17.702    | 2433.133         | 2450.835         | 2400 - 2483.5MHz | Pass    |
| NVNT      | n20  | 2472            | Ant1    | 2471.956               | 17.686    | 2463.113         | 2480.799         | 2400 - 2483.5MHz | Pass    |
| NVNT      | n40  | 2422            | Ant1    | 2422.064               | 36.044    | 2404.042         | 2440.086         | 2400 - 2483.5MHz | Pass    |
| NVNT      | n40  | 2442            | Ant1    | 2442.024               | 36.188    | 2423.93          | 2460.118         | 2400 - 2483.5MHz | Pass    |
| NVNT      | n40  | 2462            | Ant1    | 2461.968               | 36.092    | 2443.922         | 2480.014         | 2400 - 2483.5MHz | Pass    |

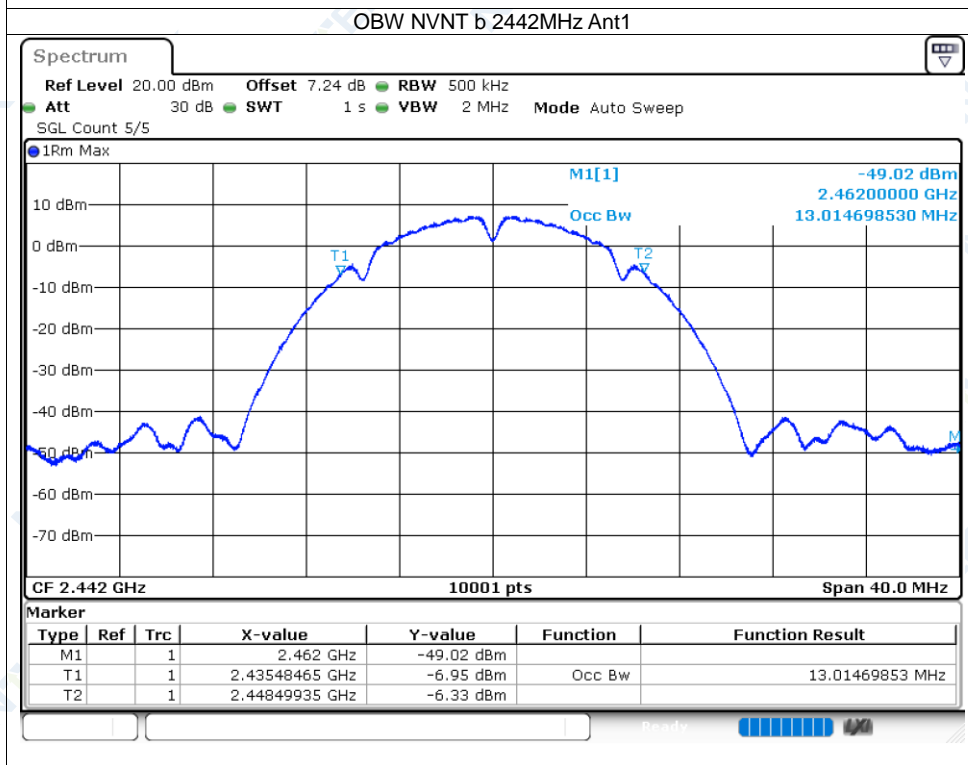
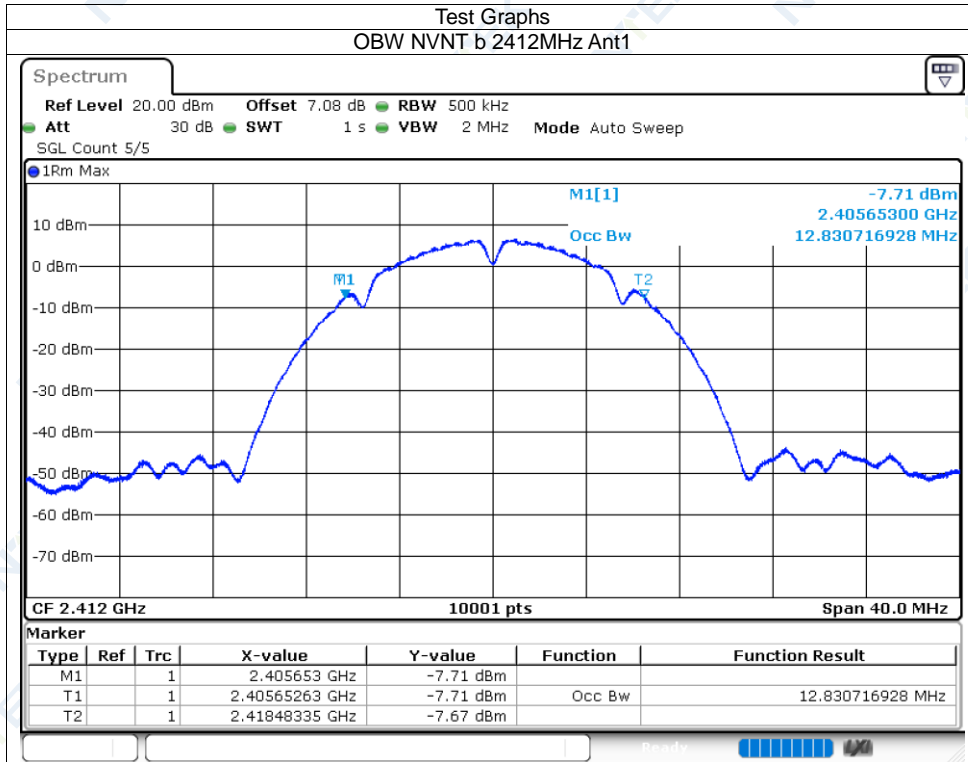

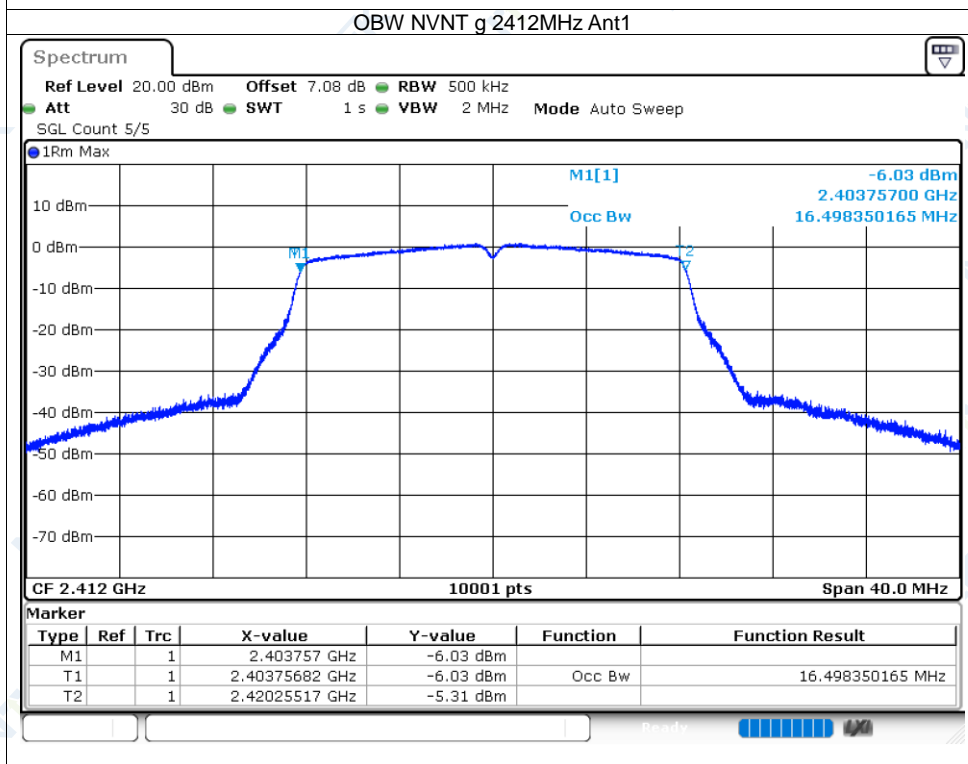
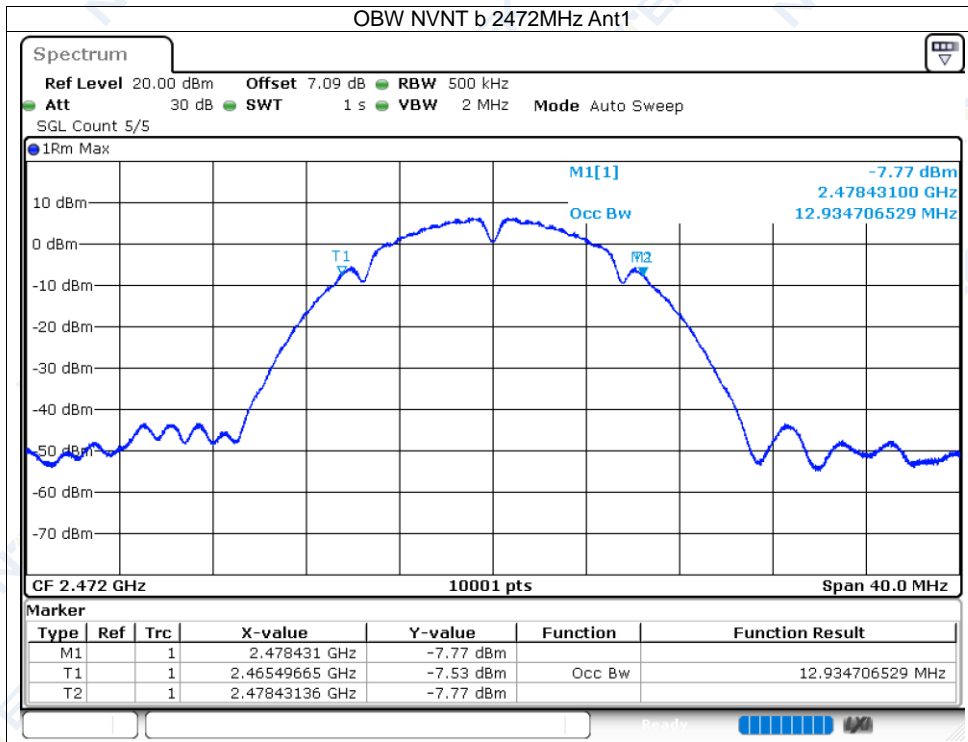

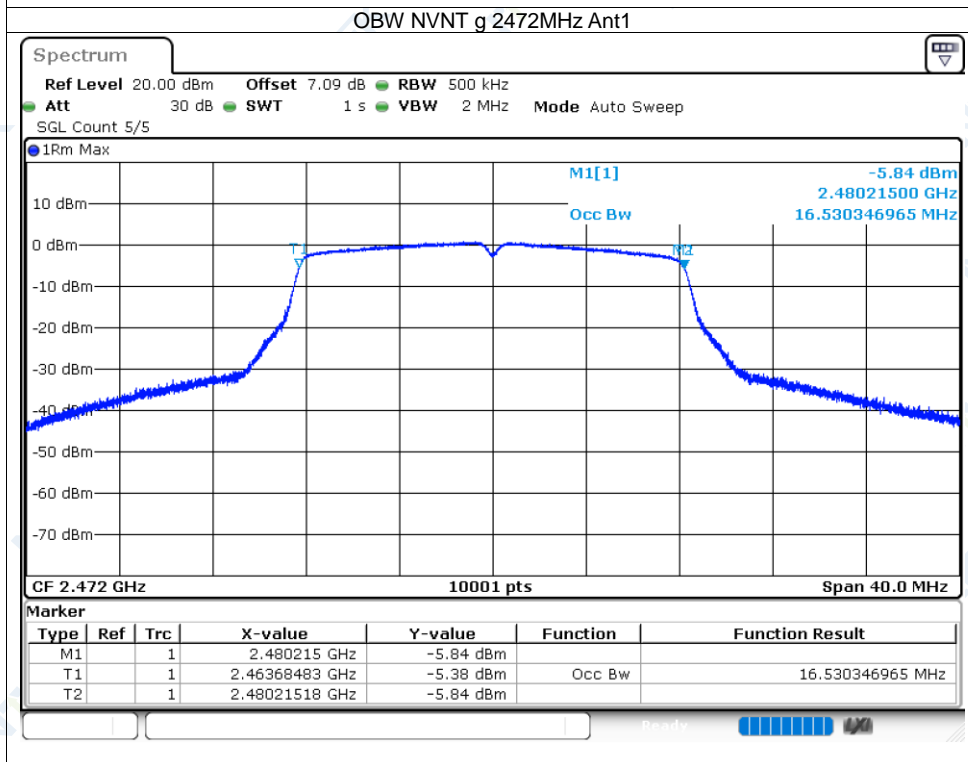
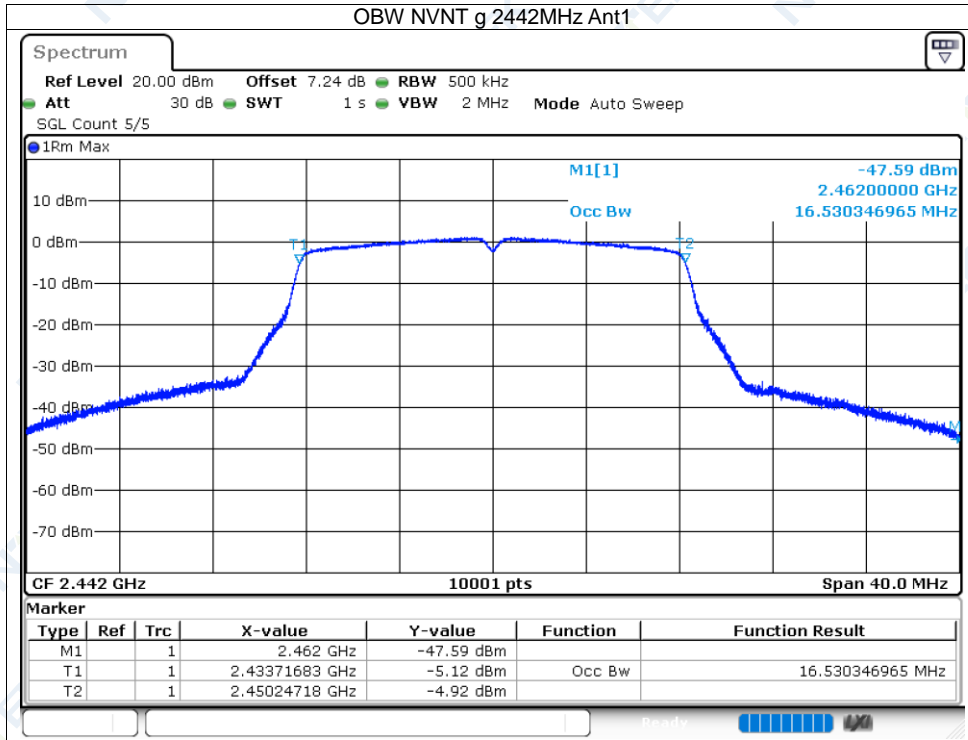

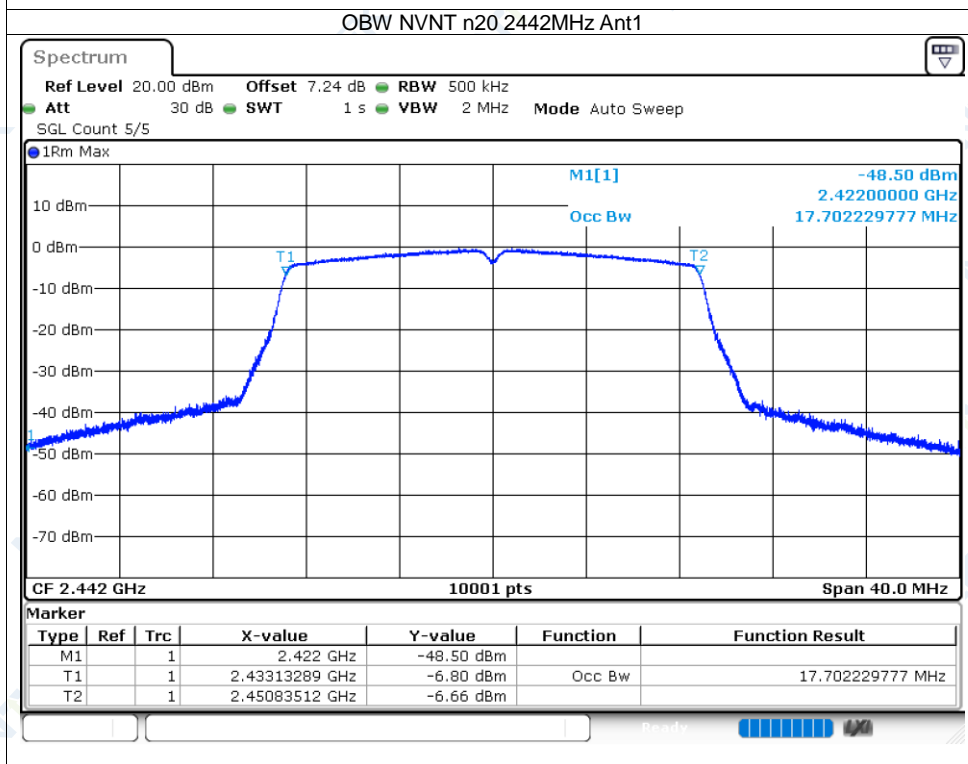
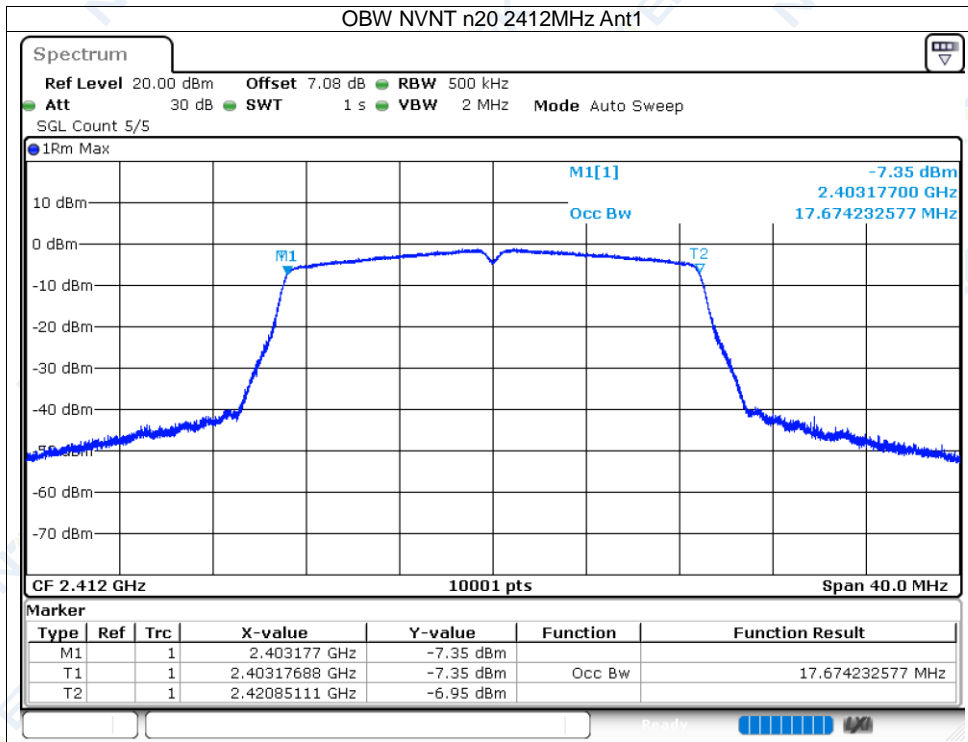

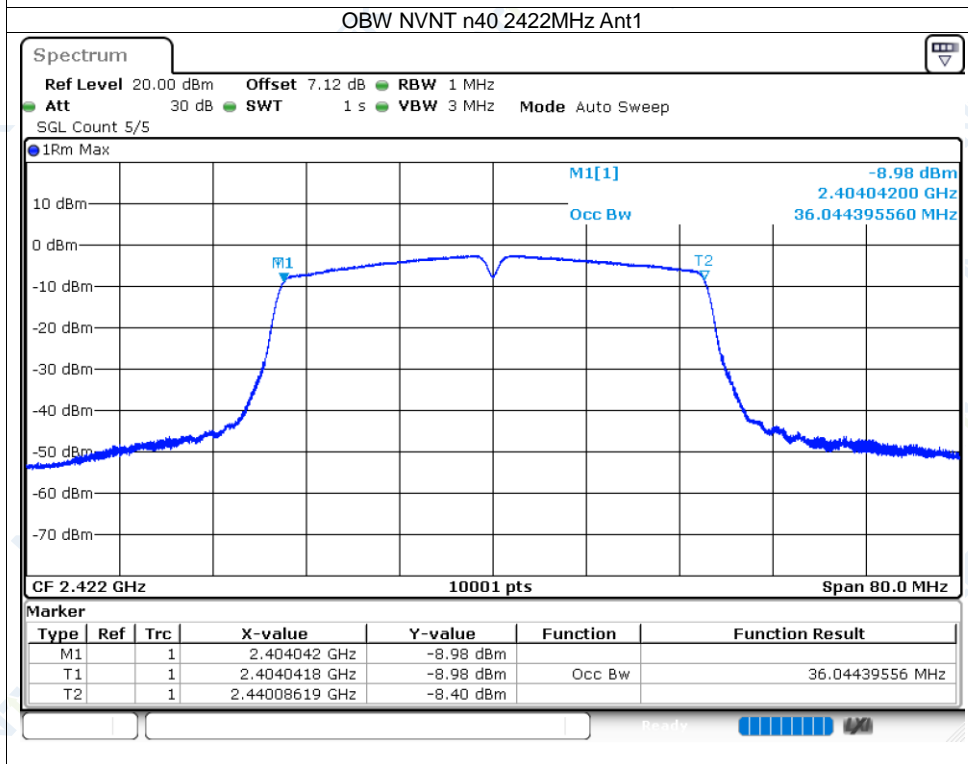
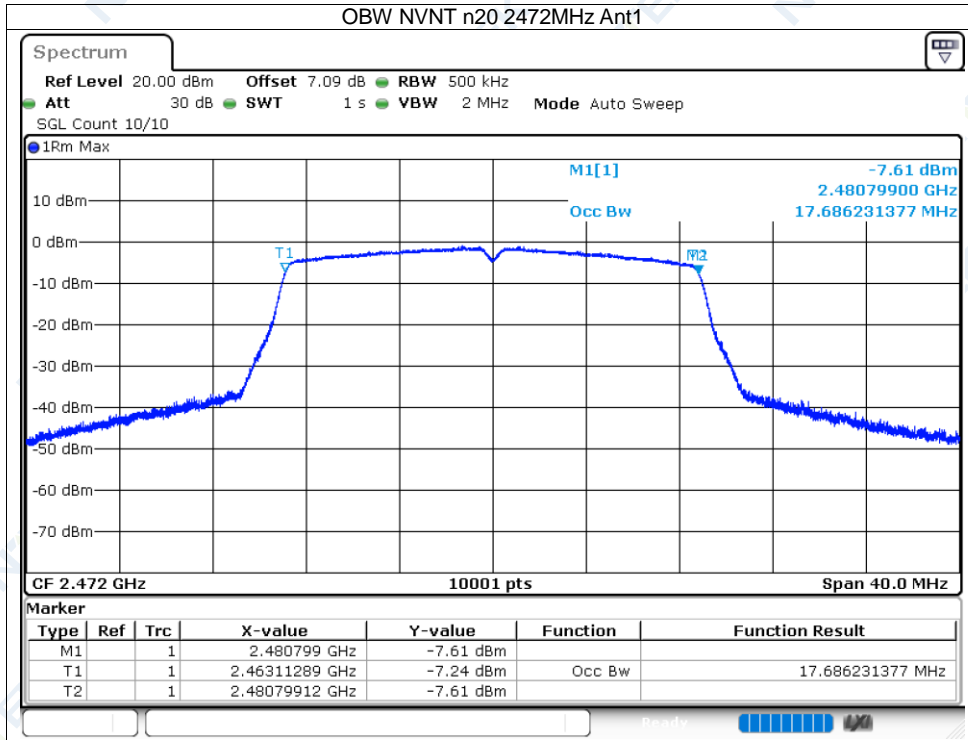

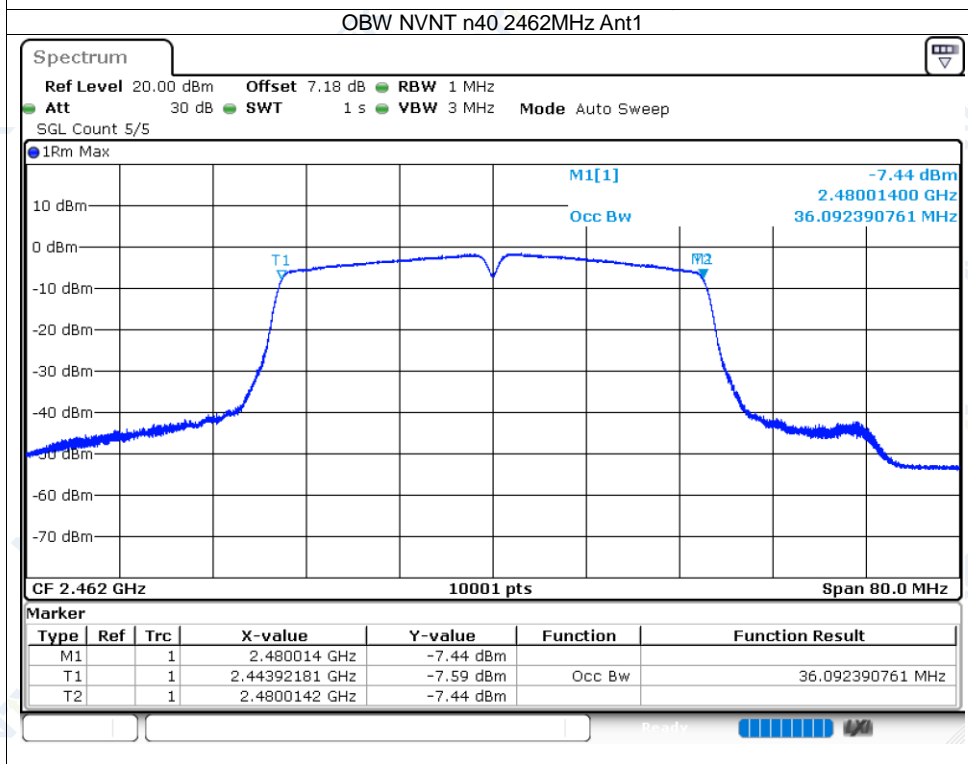
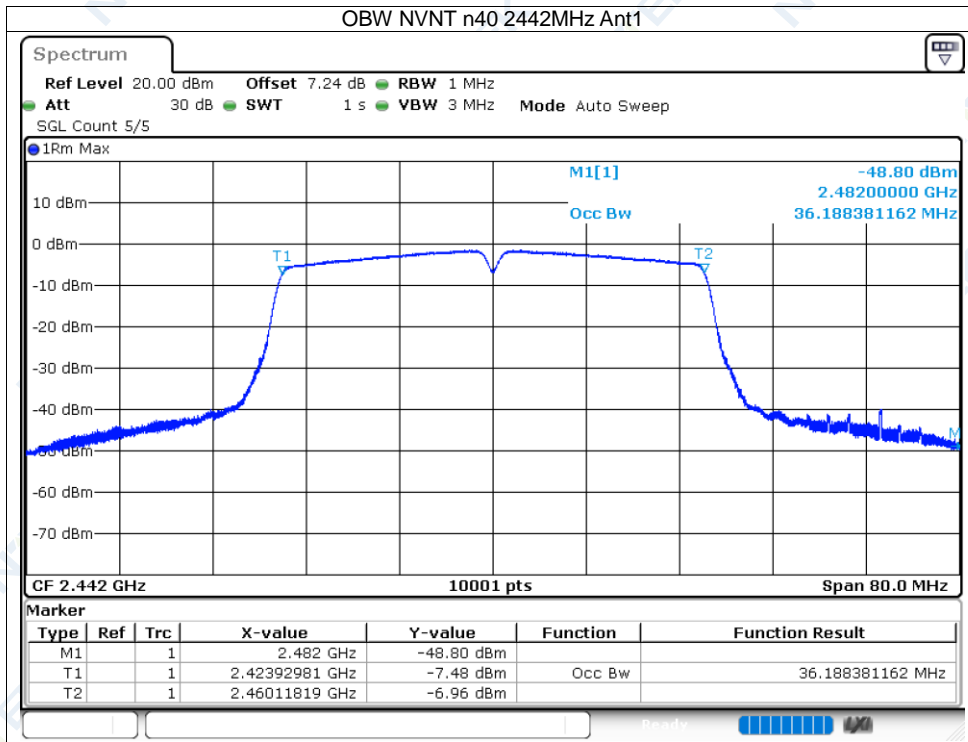



4.4 Transmitter unwanted emissions in the out-of-band domain

| Condition | Mode | Frequency (MHz) | Antenna | OOB Frequency (MHz) | Level (dBm/MHz) | Limit (dBm/MHz) | Verdict |
|-----------|------|-----------------|---------|---------------------|-----------------|-----------------|---------|
| NVNT      | b    | 2412            | Ant1    | 2399.5              | -41.52          | -10             | Pass    |
| NVNT      | b    | 2412            | Ant1    | 2398.5              | -43.34          | -10             | Pass    |
| NVNT      | b    | 2412            | Ant1    | 2397.5              | -43.88          | -10             | Pass    |
| NVNT      | b    | 2412            | Ant1    | 2396.5              | -43.97          | -10             | Pass    |
| NVNT      | b    | 2412            | Ant1    | 2395.5              | -45.58          | -10             | Pass    |
| NVNT      | b    | 2412            | Ant1    | 2394.5              | -46.71          | -10             | Pass    |
| NVNT      | b    | 2412            | Ant1    | 2393.5              | -48.84          | -10             | Pass    |
| NVNT      | b    | 2412            | Ant1    | 2392.5              | -47.15          | -10             | Pass    |
| NVNT      | b    | 2412            | Ant1    | 2391.5              | -48.33          | -10             | Pass    |
| NVNT      | b    | 2412            | Ant1    | 2390.5              | -50.89          | -10             | Pass    |
| NVNT      | b    | 2412            | Ant1    | 2389.5              | -52.63          | -10             | Pass    |
| NVNT      | b    | 2412            | Ant1    | 2388.5              | -52.1           | -10             | Pass    |
| NVNT      | b    | 2412            | Ant1    | 2387.669            | -51.71          | -10             | Pass    |
| NVNT      | b    | 2412            | Ant1    | 2386.669            | -52.15          | -20             | Pass    |
| NVNT      | b    | 2412            | Ant1    | 2385.669            | -53.39          | -20             | Pass    |
| NVNT      | b    | 2412            | Ant1    | 2384.669            | -55.27          | -20             | Pass    |
| NVNT      | b    | 2412            | Ant1    | 2383.669            | -56.31          | -20             | Pass    |
| NVNT      | b    | 2412            | Ant1    | 2382.669            | -57.31          | -20             | Pass    |
| NVNT      | b    | 2412            | Ant1    | 2381.669            | -57.79          | -20             | Pass    |
| NVNT      | b    | 2412            | Ant1    | 2380.669            | -57.99          | -20             | Pass    |
| NVNT      | b    | 2412            | Ant1    | 2379.669            | -58.1           | -20             | Pass    |
| NVNT      | b    | 2412            | Ant1    | 2378.669            | -58.08          | -20             | Pass    |
| NVNT      | b    | 2412            | Ant1    | 2377.669            | -58.17          | -20             | Pass    |
| NVNT      | b    | 2412            | Ant1    | 2376.669            | -58.18          | -20             | Pass    |
| NVNT      | b    | 2412            | Ant1    | 2375.669            | -58.17          | -20             | Pass    |
| NVNT      | b    | 2412            | Ant1    | 2374.838            | -58.19          | -20             | Pass    |
| NVNT      | b    | 2472            | Ant1    | 2484                | -42.04          | -10             | Pass    |
| NVNT      | b    | 2472            | Ant1    | 2485                | -39.91          | -10             | Pass    |
| NVNT      | b    | 2472            | Ant1    | 2486                | -48.35          | -10             | Pass    |
| NVNT      | b    | 2472            | Ant1    | 2487                | -42.91          | -10             | Pass    |
| NVNT      | b    | 2472            | Ant1    | 2488                | -45.54          | -10             | Pass    |
| NVNT      | b    | 2472            | Ant1    | 2489                | -43.01          | -10             | Pass    |
| NVNT      | b    | 2472            | Ant1    | 2490                | -47.6           | -10             | Pass    |
| NVNT      | b    | 2472            | Ant1    | 2491                | -47.26          | -10             | Pass    |
| NVNT      | b    | 2472            | Ant1    | 2492                | -45.86          | -10             | Pass    |
| NVNT      | b    | 2472            | Ant1    | 2493                | -49.37          | -10             | Pass    |
| NVNT      | b    | 2472            | Ant1    | 2494                | -54.29          | -10             | Pass    |
| NVNT      | b    | 2472            | Ant1    | 2495                | -56.3           | -10             | Pass    |
| NVNT      | b    | 2472            | Ant1    | 2495.935            | -56.85          | -10             | Pass    |
| NVNT      | b    | 2472            | Ant1    | 2496.935            | -57.27          | -20             | Pass    |
| NVNT      | b    | 2472            | Ant1    | 2497.935            | -57.65          | -20             | Pass    |
| NVNT      | b    | 2472            | Ant1    | 2498.935            | -57.82          | -20             | Pass    |
| NVNT      | b    | 2472            | Ant1    | 2499.935            | -57.86          | -20             | Pass    |
| NVNT      | b    | 2472            | Ant1    | 2500.935            | -57.88          | -20             | Pass    |
| NVNT      | b    | 2472            | Ant1    | 2501.935            | -57.88          | -20             | Pass    |
| NVNT      | b    | 2472            | Ant1    | 2502.935            | -57.9           | -20             | Pass    |
| NVNT      | b    | 2472            | Ant1    | 2503.935            | -57.91          | -20             | Pass    |
| NVNT      | b    | 2472            | Ant1    | 2504.935            | -57.91          | -20             | Pass    |
| NVNT      | b    | 2472            | Ant1    | 2505.935            | -57.93          | -20             | Pass    |
| NVNT      | b    | 2472            | Ant1    | 2506.935            | -57.92          | -20             | Pass    |
| NVNT      | b    | 2472            | Ant1    | 2507.935            | -56.29          | -20             | Pass    |
| NVNT      | b    | 2472            | Ant1    | 2508.87             | -58.05          | -20             | Pass    |
| NVNT      | g    | 2412            | Ant1    | 2399.5              | -25.43          | -10             | Pass    |
| NVNT      | g    | 2412            | Ant1    | 2398.5              | -25.92          | -10             | Pass    |
| NVNT      | g    | 2412            | Ant1    | 2397.5              | -27.04          | -10             | Pass    |

|      |   |      |      |          |        |     |      |
|------|---|------|------|----------|--------|-----|------|
| NVNT | g | 2412 | Ant1 | 2396.5   | -28.06 | -10 | Pass |
| NVNT | g | 2412 | Ant1 | 2395.5   | -29.28 | -10 | Pass |
| NVNT | g | 2412 | Ant1 | 2394.5   | -30.75 | -10 | Pass |
| NVNT | g | 2412 | Ant1 | 2393.5   | -32.26 | -10 | Pass |
| NVNT | g | 2412 | Ant1 | 2392.5   | -34.04 | -10 | Pass |
| NVNT | g | 2412 | Ant1 | 2391.5   | -36.31 | -10 | Pass |
| NVNT | g | 2412 | Ant1 | 2390.5   | -38.83 | -10 | Pass |
| NVNT | g | 2412 | Ant1 | 2389.5   | -42.1  | -10 | Pass |
| NVNT | g | 2412 | Ant1 | 2388.5   | -45.52 | -10 | Pass |
| NVNT | g | 2412 | Ant1 | 2387.5   | -47.68 | -10 | Pass |
| NVNT | g | 2412 | Ant1 | 2386.5   | -49.58 | -10 | Pass |
| NVNT | g | 2412 | Ant1 | 2385.5   | -51.55 | -10 | Pass |
| NVNT | g | 2412 | Ant1 | 2384.5   | -53.25 | -10 | Pass |
| NVNT | g | 2412 | Ant1 | 2384.002 | -54.05 | -10 | Pass |
| NVNT | g | 2412 | Ant1 | 2383.002 | -55.2  | -20 | Pass |
| NVNT | g | 2412 | Ant1 | 2382.002 | -55.91 | -20 | Pass |
| NVNT | g | 2412 | Ant1 | 2381.002 | -56.22 | -20 | Pass |
| NVNT | g | 2412 | Ant1 | 2380.002 | -56.39 | -20 | Pass |
| NVNT | g | 2412 | Ant1 | 2379.002 | -56.48 | -20 | Pass |
| NVNT | g | 2412 | Ant1 | 2378.002 | -56.52 | -20 | Pass |
| NVNT | g | 2412 | Ant1 | 2377.002 | -56.56 | -20 | Pass |
| NVNT | g | 2412 | Ant1 | 2376.002 | -56.5  | -20 | Pass |
| NVNT | g | 2412 | Ant1 | 2375.002 | -56.5  | -20 | Pass |
| NVNT | g | 2412 | Ant1 | 2374.002 | -56.55 | -20 | Pass |
| NVNT | g | 2412 | Ant1 | 2373.002 | -56.52 | -20 | Pass |
| NVNT | g | 2412 | Ant1 | 2372.002 | -56.53 | -20 | Pass |
| NVNT | g | 2412 | Ant1 | 2371.002 | -56.52 | -20 | Pass |
| NVNT | g | 2412 | Ant1 | 2370.002 | -56.53 | -20 | Pass |
| NVNT | g | 2412 | Ant1 | 2369.002 | -56.48 | -20 | Pass |
| NVNT | g | 2412 | Ant1 | 2368.002 | -56.4  | -20 | Pass |
| NVNT | g | 2412 | Ant1 | 2367.504 | -56.39 | -20 | Pass |
| NVNT | g | 2472 | Ant1 | 2484     | -20.96 | -10 | Pass |
| NVNT | g | 2472 | Ant1 | 2485     | -21.45 | -10 | Pass |
| NVNT | g | 2472 | Ant1 | 2486     | -22.79 | -10 | Pass |
| NVNT | g | 2472 | Ant1 | 2487     | -23.87 | -10 | Pass |
| NVNT | g | 2472 | Ant1 | 2488     | -24.97 | -10 | Pass |
| NVNT | g | 2472 | Ant1 | 2489     | -25.88 | -10 | Pass |
| NVNT | g | 2472 | Ant1 | 2490     | -26.91 | -10 | Pass |
| NVNT | g | 2472 | Ant1 | 2491     | -28.04 | -10 | Pass |
| NVNT | g | 2472 | Ant1 | 2492     | -29.59 | -10 | Pass |
| NVNT | g | 2472 | Ant1 | 2493     | -32.5  | -10 | Pass |
| NVNT | g | 2472 | Ant1 | 2494     | -38.36 | -10 | Pass |
| NVNT | g | 2472 | Ant1 | 2495     | -45.09 | -10 | Pass |
| NVNT | g | 2472 | Ant1 | 2496     | -50.68 | -10 | Pass |
| NVNT | g | 2472 | Ant1 | 2497     | -54.01 | -10 | Pass |
| NVNT | g | 2472 | Ant1 | 2498     | -55.53 | -10 | Pass |
| NVNT | g | 2472 | Ant1 | 2499     | -56.05 | -10 | Pass |
| NVNT | g | 2472 | Ant1 | 2499.53  | -56.07 | -10 | Pass |
| NVNT | g | 2472 | Ant1 | 2500.53  | -56.21 | -20 | Pass |
| NVNT | g | 2472 | Ant1 | 2501.53  | -56.24 | -20 | Pass |
| NVNT | g | 2472 | Ant1 | 2502.53  | -56.24 | -20 | Pass |
| NVNT | g | 2472 | Ant1 | 2503.53  | -56.24 | -20 | Pass |
| NVNT | g | 2472 | Ant1 | 2504.53  | -56.27 | -20 | Pass |
| NVNT | g | 2472 | Ant1 | 2505.53  | -56.21 | -20 | Pass |
| NVNT | g | 2472 | Ant1 | 2506.53  | -56.21 | -20 | Pass |
| NVNT | g | 2472 | Ant1 | 2507.53  | -56.25 | -20 | Pass |
| NVNT | g | 2472 | Ant1 | 2508.53  | -56.39 | -20 | Pass |
| NVNT | g | 2472 | Ant1 | 2509.53  | -56.33 | -20 | Pass |
| NVNT | g | 2472 | Ant1 | 2510.53  | -54.64 | -20 | Pass |
| NVNT | g | 2472 | Ant1 | 2511.53  | -56.37 | -20 | Pass |

|      |     |      |      |          |        |     |      |
|------|-----|------|------|----------|--------|-----|------|
| NVNT | g   | 2472 | Ant1 | 2512.53  | -56.12 | -20 | Pass |
| NVNT | g   | 2472 | Ant1 | 2513.53  | -56.19 | -20 | Pass |
| NVNT | g   | 2472 | Ant1 | 2514.53  | -56.26 | -20 | Pass |
| NVNT | g   | 2472 | Ant1 | 2515.53  | -56.27 | -20 | Pass |
| NVNT | g   | 2472 | Ant1 | 2516.06  | -56.19 | -20 | Pass |
| NVNT | n20 | 2412 | Ant1 | 2399.5   | -29.06 | -10 | Pass |
| NVNT | n20 | 2412 | Ant1 | 2398.5   | -28.33 | -10 | Pass |
| NVNT | n20 | 2412 | Ant1 | 2397.5   | -29.29 | -10 | Pass |
| NVNT | n20 | 2412 | Ant1 | 2396.5   | -30.35 | -10 | Pass |
| NVNT | n20 | 2412 | Ant1 | 2395.5   | -31.3  | -10 | Pass |
| NVNT | n20 | 2412 | Ant1 | 2394.5   | -33.04 | -10 | Pass |
| NVNT | n20 | 2412 | Ant1 | 2393.5   | -34.73 | -10 | Pass |
| NVNT | n20 | 2412 | Ant1 | 2392.5   | -37.24 | -10 | Pass |
| NVNT | n20 | 2412 | Ant1 | 2391.5   | -39.39 | -10 | Pass |
| NVNT | n20 | 2412 | Ant1 | 2390.5   | -41.97 | -10 | Pass |
| NVNT | n20 | 2412 | Ant1 | 2389.5   | -44.16 | -10 | Pass |
| NVNT | n20 | 2412 | Ant1 | 2388.5   | -46.18 | -10 | Pass |
| NVNT | n20 | 2412 | Ant1 | 2387.5   | -48.05 | -10 | Pass |
| NVNT | n20 | 2412 | Ant1 | 2386.5   | -50.58 | -10 | Pass |
| NVNT | n20 | 2412 | Ant1 | 2385.5   | -52.57 | -10 | Pass |
| NVNT | n20 | 2412 | Ant1 | 2384.5   | -54.57 | -10 | Pass |
| NVNT | n20 | 2412 | Ant1 | 2383.5   | -55.56 | -10 | Pass |
| NVNT | n20 | 2412 | Ant1 | 2382.826 | -55.94 | -10 | Pass |
| NVNT | n20 | 2412 | Ant1 | 2381.826 | -56.24 | -20 | Pass |
| NVNT | n20 | 2412 | Ant1 | 2380.826 | -56.39 | -20 | Pass |
| NVNT | n20 | 2412 | Ant1 | 2379.826 | -56.41 | -20 | Pass |
| NVNT | n20 | 2412 | Ant1 | 2378.826 | -56.47 | -20 | Pass |
| NVNT | n20 | 2412 | Ant1 | 2377.826 | -56.45 | -20 | Pass |
| NVNT | n20 | 2412 | Ant1 | 2376.826 | -56.48 | -20 | Pass |
| NVNT | n20 | 2412 | Ant1 | 2375.826 | -56.48 | -20 | Pass |
| NVNT | n20 | 2412 | Ant1 | 2374.826 | -56.51 | -20 | Pass |
| NVNT | n20 | 2412 | Ant1 | 2373.826 | -56.47 | -20 | Pass |
| NVNT | n20 | 2412 | Ant1 | 2372.826 | -56.5  | -20 | Pass |
| NVNT | n20 | 2412 | Ant1 | 2371.826 | -56.51 | -20 | Pass |
| NVNT | n20 | 2412 | Ant1 | 2370.826 | -56.4  | -20 | Pass |
| NVNT | n20 | 2412 | Ant1 | 2369.826 | -56.47 | -20 | Pass |
| NVNT | n20 | 2412 | Ant1 | 2368.826 | -56.41 | -20 | Pass |
| NVNT | n20 | 2412 | Ant1 | 2367.826 | -56.4  | -20 | Pass |
| NVNT | n20 | 2412 | Ant1 | 2366.826 | -56.4  | -20 | Pass |
| NVNT | n20 | 2412 | Ant1 | 2365.826 | -56.39 | -20 | Pass |
| NVNT | n20 | 2412 | Ant1 | 2365.152 | -56.36 | -20 | Pass |
| NVNT | n20 | 2472 | Ant1 | 2484     | -25.86 | -10 | Pass |
| NVNT | n20 | 2472 | Ant1 | 2485     | -26.01 | -10 | Pass |
| NVNT | n20 | 2472 | Ant1 | 2486     | -27.96 | -10 | Pass |
| NVNT | n20 | 2472 | Ant1 | 2487     | -28.86 | -10 | Pass |
| NVNT | n20 | 2472 | Ant1 | 2488     | -30.37 | -10 | Pass |
| NVNT | n20 | 2472 | Ant1 | 2489     | -31.39 | -10 | Pass |
| NVNT | n20 | 2472 | Ant1 | 2490     | -32.6  | -10 | Pass |
| NVNT | n20 | 2472 | Ant1 | 2491     | -33.35 | -10 | Pass |
| NVNT | n20 | 2472 | Ant1 | 2492     | -34.34 | -10 | Pass |
| NVNT | n20 | 2472 | Ant1 | 2493     | -35.89 | -10 | Pass |
| NVNT | n20 | 2472 | Ant1 | 2494     | -38.78 | -10 | Pass |
| NVNT | n20 | 2472 | Ant1 | 2495     | -44.5  | -10 | Pass |
| NVNT | n20 | 2472 | Ant1 | 2496     | -50.36 | -10 | Pass |
| NVNT | n20 | 2472 | Ant1 | 2497     | -54.46 | -10 | Pass |
| NVNT | n20 | 2472 | Ant1 | 2498     | -55.81 | -10 | Pass |
| NVNT | n20 | 2472 | Ant1 | 2499     | -56.1  | -10 | Pass |
| NVNT | n20 | 2472 | Ant1 | 2500     | -56.15 | -10 | Pass |
| NVNT | n20 | 2472 | Ant1 | 2500.686 | -56.16 | -10 | Pass |
| NVNT | n20 | 2472 | Ant1 | 2501.686 | -56.15 | -20 | Pass |

|      |     |      |      |          |        |     |      |
|------|-----|------|------|----------|--------|-----|------|
| NVNT | n20 | 2472 | Ant1 | 2502.686 | -56.2  | -20 | Pass |
| NVNT | n20 | 2472 | Ant1 | 2503.686 | -56.2  | -20 | Pass |
| NVNT | n20 | 2472 | Ant1 | 2504.686 | -56.2  | -20 | Pass |
| NVNT | n20 | 2472 | Ant1 | 2505.686 | -56.22 | -20 | Pass |
| NVNT | n20 | 2472 | Ant1 | 2506.686 | -56.2  | -20 | Pass |
| NVNT | n20 | 2472 | Ant1 | 2507.686 | -56.19 | -20 | Pass |
| NVNT | n20 | 2472 | Ant1 | 2508.686 | -56.3  | -20 | Pass |
| NVNT | n20 | 2472 | Ant1 | 2509.686 | -56.27 | -20 | Pass |
| NVNT | n20 | 2472 | Ant1 | 2510.686 | -54.59 | -20 | Pass |
| NVNT | n20 | 2472 | Ant1 | 2511.686 | -56.33 | -20 | Pass |
| NVNT | n20 | 2472 | Ant1 | 2512.686 | -56.33 | -20 | Pass |
| NVNT | n20 | 2472 | Ant1 | 2513.686 | -56.12 | -20 | Pass |
| NVNT | n20 | 2472 | Ant1 | 2514.686 | -56.2  | -20 | Pass |
| NVNT | n20 | 2472 | Ant1 | 2515.686 | -56.21 | -20 | Pass |
| NVNT | n20 | 2472 | Ant1 | 2516.686 | -56.15 | -20 | Pass |
| NVNT | n20 | 2472 | Ant1 | 2517.686 | -56.18 | -20 | Pass |
| NVNT | n20 | 2472 | Ant1 | 2518.372 | -55.97 | -20 | Pass |
| NVNT | n40 | 2422 | Ant1 | 2399.5   | -35.26 | -10 | Pass |
| NVNT | n40 | 2422 | Ant1 | 2398.5   | -35.19 | -10 | Pass |
| NVNT | n40 | 2422 | Ant1 | 2397.5   | -37.45 | -10 | Pass |
| NVNT | n40 | 2422 | Ant1 | 2396.5   | -36.04 | -10 | Pass |
| NVNT | n40 | 2422 | Ant1 | 2395.5   | -36.88 | -10 | Pass |
| NVNT | n40 | 2422 | Ant1 | 2394.5   | -35.9  | -10 | Pass |
| NVNT | n40 | 2422 | Ant1 | 2393.5   | -34.57 | -10 | Pass |
| NVNT | n40 | 2422 | Ant1 | 2392.5   | -36.36 | -10 | Pass |
| NVNT | n40 | 2422 | Ant1 | 2391.5   | -36.75 | -10 | Pass |
| NVNT | n40 | 2422 | Ant1 | 2390.5   | -37.12 | -10 | Pass |
| NVNT | n40 | 2422 | Ant1 | 2389.5   | -36.96 | -10 | Pass |
| NVNT | n40 | 2422 | Ant1 | 2388.5   | -37.59 | -10 | Pass |
| NVNT | n40 | 2422 | Ant1 | 2387.5   | -38.9  | -10 | Pass |
| NVNT | n40 | 2422 | Ant1 | 2386.5   | -41.06 | -10 | Pass |
| NVNT | n40 | 2422 | Ant1 | 2385.5   | -43.65 | -10 | Pass |
| NVNT | n40 | 2422 | Ant1 | 2384.5   | -47.44 | -10 | Pass |
| NVNT | n40 | 2422 | Ant1 | 2383.5   | -51.87 | -10 | Pass |
| NVNT | n40 | 2422 | Ant1 | 2382.5   | -53.92 | -10 | Pass |
| NVNT | n40 | 2422 | Ant1 | 2381.5   | -55.5  | -10 | Pass |
| NVNT | n40 | 2422 | Ant1 | 2380.5   | -55.97 | -10 | Pass |
| NVNT | n40 | 2422 | Ant1 | 2379.5   | -56.08 | -10 | Pass |
| NVNT | n40 | 2422 | Ant1 | 2378.5   | -56.12 | -10 | Pass |
| NVNT | n40 | 2422 | Ant1 | 2377.5   | -56.11 | -10 | Pass |
| NVNT | n40 | 2422 | Ant1 | 2376.5   | -56.11 | -10 | Pass |
| NVNT | n40 | 2422 | Ant1 | 2375.5   | -56.07 | -10 | Pass |
| NVNT | n40 | 2422 | Ant1 | 2374.5   | -56.13 | -10 | Pass |
| NVNT | n40 | 2422 | Ant1 | 2373.5   | -56.08 | -10 | Pass |
| NVNT | n40 | 2422 | Ant1 | 2372.5   | -56.11 | -10 | Pass |
| NVNT | n40 | 2422 | Ant1 | 2371.5   | -56.07 | -10 | Pass |
| NVNT | n40 | 2422 | Ant1 | 2370.5   | -56.17 | -10 | Pass |
| NVNT | n40 | 2422 | Ant1 | 2369.5   | -56.13 | -10 | Pass |
| NVNT | n40 | 2422 | Ant1 | 2368.5   | -56.1  | -10 | Pass |
| NVNT | n40 | 2422 | Ant1 | 2367.5   | -56.09 | -10 | Pass |
| NVNT | n40 | 2422 | Ant1 | 2366.5   | -56.13 | -10 | Pass |
| NVNT | n40 | 2422 | Ant1 | 2365.5   | -56.1  | -10 | Pass |
| NVNT | n40 | 2422 | Ant1 | 2364.5   | -56.01 | -10 | Pass |
| NVNT | n40 | 2422 | Ant1 | 2364.456 | -56.07 | -10 | Pass |
| NVNT | n40 | 2422 | Ant1 | 2363.456 | -56.08 | -20 | Pass |
| NVNT | n40 | 2422 | Ant1 | 2362.456 | -56.08 | -20 | Pass |
| NVNT | n40 | 2422 | Ant1 | 2361.456 | -56.01 | -20 | Pass |
| NVNT | n40 | 2422 | Ant1 | 2360.456 | -56.08 | -20 | Pass |
| NVNT | n40 | 2422 | Ant1 | 2359.456 | -56.13 | -20 | Pass |
| NVNT | n40 | 2422 | Ant1 | 2358.456 | -56.08 | -20 | Pass |



|      |     |      |      |          |        |     |      |
|------|-----|------|------|----------|--------|-----|------|
| NVNT | n40 | 2422 | Ant1 | 2357.456 | -56.12 | -20 | Pass |
| NVNT | n40 | 2422 | Ant1 | 2356.456 | -56.02 | -20 | Pass |
| NVNT | n40 | 2422 | Ant1 | 2355.456 | -56.12 | -20 | Pass |
| NVNT | n40 | 2422 | Ant1 | 2354.456 | -56.1  | -20 | Pass |
| NVNT | n40 | 2422 | Ant1 | 2353.456 | -56.11 | -20 | Pass |
| NVNT | n40 | 2422 | Ant1 | 2352.456 | -56.15 | -20 | Pass |
| NVNT | n40 | 2422 | Ant1 | 2351.456 | -56.14 | -20 | Pass |
| NVNT | n40 | 2422 | Ant1 | 2350.456 | -56.07 | -20 | Pass |
| NVNT | n40 | 2422 | Ant1 | 2349.456 | -56.11 | -20 | Pass |
| NVNT | n40 | 2422 | Ant1 | 2348.456 | -56.14 | -20 | Pass |
| NVNT | n40 | 2422 | Ant1 | 2347.456 | -56.12 | -20 | Pass |
| NVNT | n40 | 2422 | Ant1 | 2346.456 | -56.03 | -20 | Pass |
| NVNT | n40 | 2422 | Ant1 | 2345.456 | -56.13 | -20 | Pass |
| NVNT | n40 | 2422 | Ant1 | 2344.456 | -56.11 | -20 | Pass |
| NVNT | n40 | 2422 | Ant1 | 2343.456 | -56.27 | -20 | Pass |
| NVNT | n40 | 2422 | Ant1 | 2342.456 | -56.21 | -20 | Pass |
| NVNT | n40 | 2422 | Ant1 | 2341.456 | -56.22 | -20 | Pass |
| NVNT | n40 | 2422 | Ant1 | 2340.456 | -56.31 | -20 | Pass |
| NVNT | n40 | 2422 | Ant1 | 2339.456 | -56.08 | -20 | Pass |
| NVNT | n40 | 2422 | Ant1 | 2338.456 | -56.12 | -20 | Pass |
| NVNT | n40 | 2422 | Ant1 | 2337.456 | -56.1  | -20 | Pass |
| NVNT | n40 | 2422 | Ant1 | 2336.456 | -56.1  | -20 | Pass |
| NVNT | n40 | 2422 | Ant1 | 2335.456 | -56.08 | -20 | Pass |
| NVNT | n40 | 2422 | Ant1 | 2334.456 | -56.05 | -20 | Pass |
| NVNT | n40 | 2422 | Ant1 | 2333.456 | -56.08 | -20 | Pass |
| NVNT | n40 | 2422 | Ant1 | 2332.456 | -56.1  | -20 | Pass |
| NVNT | n40 | 2422 | Ant1 | 2331.456 | -56.1  | -20 | Pass |
| NVNT | n40 | 2422 | Ant1 | 2330.456 | -56.04 | -20 | Pass |
| NVNT | n40 | 2422 | Ant1 | 2329.456 | -56.1  | -20 | Pass |
| NVNT | n40 | 2422 | Ant1 | 2328.456 | -56.01 | -20 | Pass |
| NVNT | n40 | 2422 | Ant1 | 2328.412 | -56.13 | -20 | Pass |
| NVNT | n40 | 2462 | Ant1 | 2484     | -32.11 | -10 | Pass |
| NVNT | n40 | 2462 | Ant1 | 2485     | -29.36 | -10 | Pass |
| NVNT | n40 | 2462 | Ant1 | 2486     | -29.88 | -10 | Pass |
| NVNT | n40 | 2462 | Ant1 | 2487     | -30.32 | -10 | Pass |
| NVNT | n40 | 2462 | Ant1 | 2488     | -33.03 | -10 | Pass |
| NVNT | n40 | 2462 | Ant1 | 2489     | -32.21 | -10 | Pass |
| NVNT | n40 | 2462 | Ant1 | 2490     | -30.87 | -10 | Pass |
| NVNT | n40 | 2462 | Ant1 | 2491     | -32.96 | -10 | Pass |
| NVNT | n40 | 2462 | Ant1 | 2492     | -29.91 | -10 | Pass |
| NVNT | n40 | 2462 | Ant1 | 2493     | -29.4  | -10 | Pass |
| NVNT | n40 | 2462 | Ant1 | 2494     | -31.54 | -10 | Pass |
| NVNT | n40 | 2462 | Ant1 | 2495     | -35.03 | -10 | Pass |
| NVNT | n40 | 2462 | Ant1 | 2496     | -43.15 | -10 | Pass |
| NVNT | n40 | 2462 | Ant1 | 2497     | -48.53 | -10 | Pass |
| NVNT | n40 | 2462 | Ant1 | 2498     | -52.78 | -10 | Pass |
| NVNT | n40 | 2462 | Ant1 | 2499     | -55.42 | -10 | Pass |
| NVNT | n40 | 2462 | Ant1 | 2500     | -55.66 | -10 | Pass |
| NVNT | n40 | 2462 | Ant1 | 2501     | -55.7  | -10 | Pass |
| NVNT | n40 | 2462 | Ant1 | 2502     | -55.77 | -10 | Pass |
| NVNT | n40 | 2462 | Ant1 | 2503     | -55.79 | -10 | Pass |
| NVNT | n40 | 2462 | Ant1 | 2504     | -55.79 | -10 | Pass |
| NVNT | n40 | 2462 | Ant1 | 2505     | -55.81 | -10 | Pass |
| NVNT | n40 | 2462 | Ant1 | 2506     | -55.8  | -10 | Pass |
| NVNT | n40 | 2462 | Ant1 | 2507     | -55.79 | -10 | Pass |
| NVNT | n40 | 2462 | Ant1 | 2508     | -54.2  | -10 | Pass |
| NVNT | n40 | 2462 | Ant1 | 2509     | -55.89 | -10 | Pass |
| NVNT | n40 | 2462 | Ant1 | 2510     | -54.17 | -10 | Pass |
| NVNT | n40 | 2462 | Ant1 | 2511     | -55.96 | -10 | Pass |
| NVNT | n40 | 2462 | Ant1 | 2512     | -55.92 | -10 | Pass |

|      |     |      |      |          |        |     |      |
|------|-----|------|------|----------|--------|-----|------|
| NVNT | n40 | 2462 | Ant1 | 2513     | -55.97 | -10 | Pass |
| NVNT | n40 | 2462 | Ant1 | 2514     | -55.81 | -10 | Pass |
| NVNT | n40 | 2462 | Ant1 | 2515     | -55.79 | -10 | Pass |
| NVNT | n40 | 2462 | Ant1 | 2516     | -55.81 | -10 | Pass |
| NVNT | n40 | 2462 | Ant1 | 2517     | -55.79 | -10 | Pass |
| NVNT | n40 | 2462 | Ant1 | 2518     | -55.63 | -10 | Pass |
| NVNT | n40 | 2462 | Ant1 | 2519     | -55.55 | -10 | Pass |
| NVNT | n40 | 2462 | Ant1 | 2519.092 | -55.67 | -10 | Pass |
| NVNT | n40 | 2462 | Ant1 | 2520.092 | -55.66 | -20 | Pass |
| NVNT | n40 | 2462 | Ant1 | 2521.092 | -55.63 | -20 | Pass |
| NVNT | n40 | 2462 | Ant1 | 2522.092 | -55.73 | -20 | Pass |
| NVNT | n40 | 2462 | Ant1 | 2523.092 | -55.7  | -20 | Pass |
| NVNT | n40 | 2462 | Ant1 | 2524.092 | -55.78 | -20 | Pass |
| NVNT | n40 | 2462 | Ant1 | 2525.092 | -55.76 | -20 | Pass |
| NVNT | n40 | 2462 | Ant1 | 2526.092 | -55.77 | -20 | Pass |
| NVNT | n40 | 2462 | Ant1 | 2527.092 | -52.6  | -20 | Pass |
| NVNT | n40 | 2462 | Ant1 | 2528.092 | -51.76 | -20 | Pass |
| NVNT | n40 | 2462 | Ant1 | 2529.092 | -55.51 | -20 | Pass |
| NVNT | n40 | 2462 | Ant1 | 2530.092 | -55.73 | -20 | Pass |
| NVNT | n40 | 2462 | Ant1 | 2531.092 | -55.75 | -20 | Pass |
| NVNT | n40 | 2462 | Ant1 | 2532.092 | -55.21 | -20 | Pass |
| NVNT | n40 | 2462 | Ant1 | 2533.092 | -50.24 | -20 | Pass |
| NVNT | n40 | 2462 | Ant1 | 2534.092 | -46.52 | -20 | Pass |
| NVNT | n40 | 2462 | Ant1 | 2535.092 | -55.72 | -20 | Pass |
| NVNT | n40 | 2462 | Ant1 | 2536.092 | -55.77 | -20 | Pass |
| NVNT | n40 | 2462 | Ant1 | 2537.092 | -55.63 | -20 | Pass |
| NVNT | n40 | 2462 | Ant1 | 2538.092 | -55.72 | -20 | Pass |
| NVNT | n40 | 2462 | Ant1 | 2539.092 | -55.79 | -20 | Pass |
| NVNT | n40 | 2462 | Ant1 | 2540.092 | -55.72 | -20 | Pass |
| NVNT | n40 | 2462 | Ant1 | 2541.092 | -55.72 | -20 | Pass |
| NVNT | n40 | 2462 | Ant1 | 2542.092 | -55.73 | -20 | Pass |
| NVNT | n40 | 2462 | Ant1 | 2543.092 | -55.75 | -20 | Pass |
| NVNT | n40 | 2462 | Ant1 | 2544.092 | -55.72 | -20 | Pass |
| NVNT | n40 | 2462 | Ant1 | 2545.092 | -55.71 | -20 | Pass |
| NVNT | n40 | 2462 | Ant1 | 2546.092 | -55.63 | -20 | Pass |
| NVNT | n40 | 2462 | Ant1 | 2547.092 | -55.7  | -20 | Pass |
| NVNT | n40 | 2462 | Ant1 | 2548.092 | -55.47 | -20 | Pass |
| NVNT | n40 | 2462 | Ant1 | 2549.092 | -54.6  | -20 | Pass |
| NVNT | n40 | 2462 | Ant1 | 2550.092 | -55.03 | -20 | Pass |
| NVNT | n40 | 2462 | Ant1 | 2551.092 | -55.49 | -20 | Pass |
| NVNT | n40 | 2462 | Ant1 | 2552.092 | -55.19 | -20 | Pass |
| NVNT | n40 | 2462 | Ant1 | 2553.092 | -55.71 | -20 | Pass |
| NVNT | n40 | 2462 | Ant1 | 2554.092 | -55.6  | -20 | Pass |
| NVNT | n40 | 2462 | Ant1 | 2555.092 | -55.72 | -20 | Pass |
| NVNT | n40 | 2462 | Ant1 | 2555.184 | -55.72 | -20 | Pass |

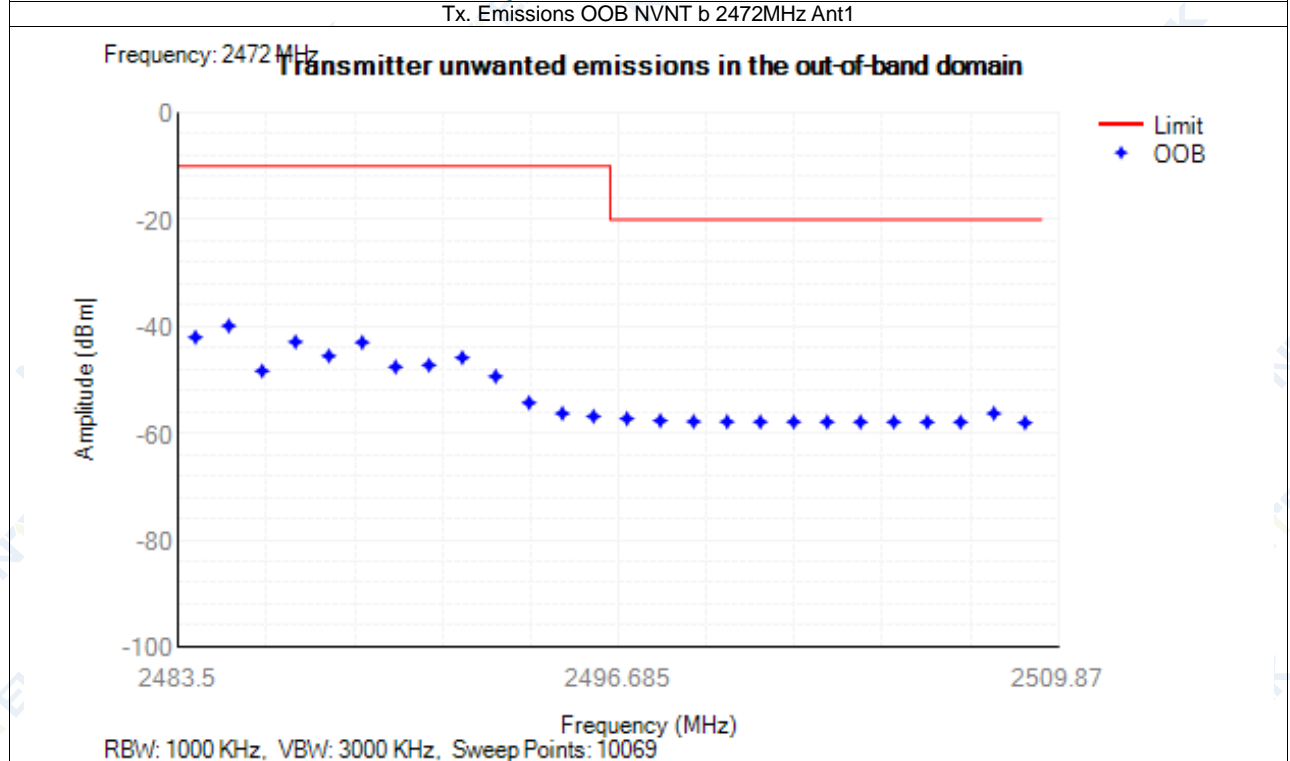
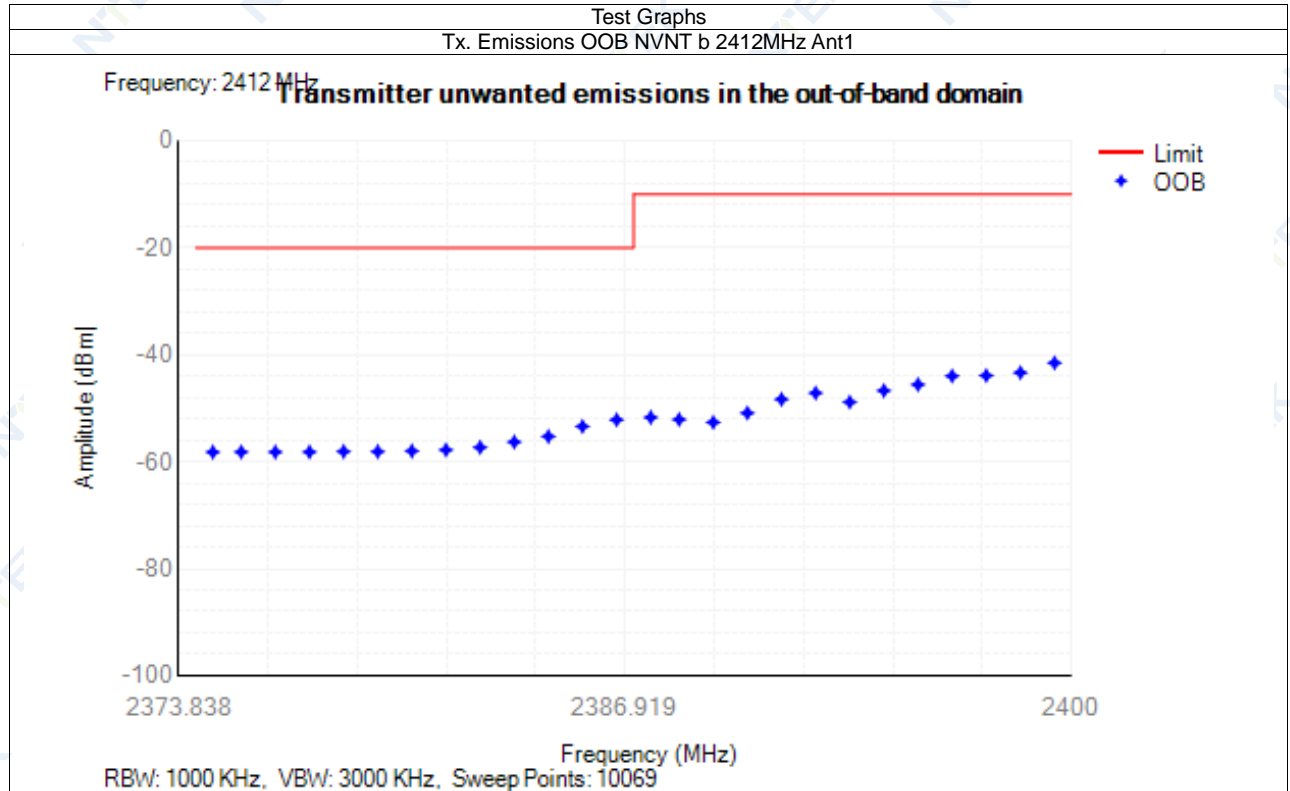



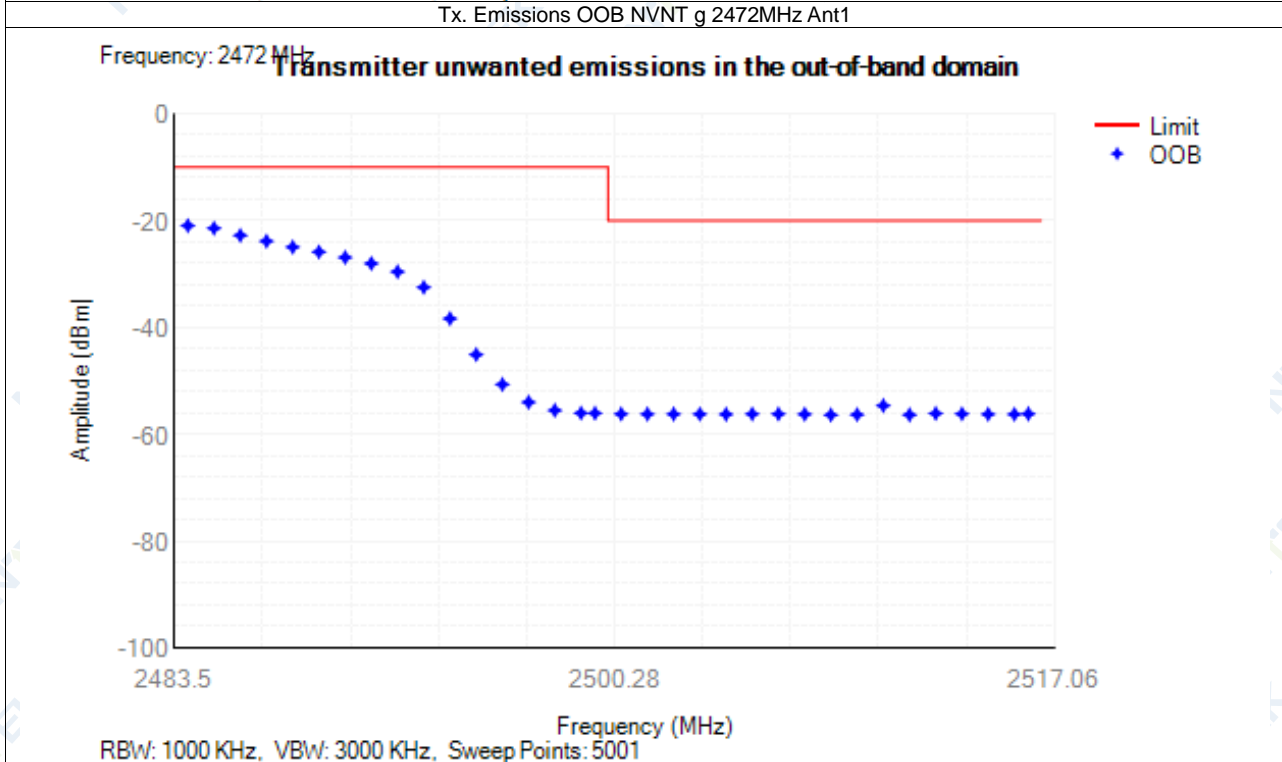
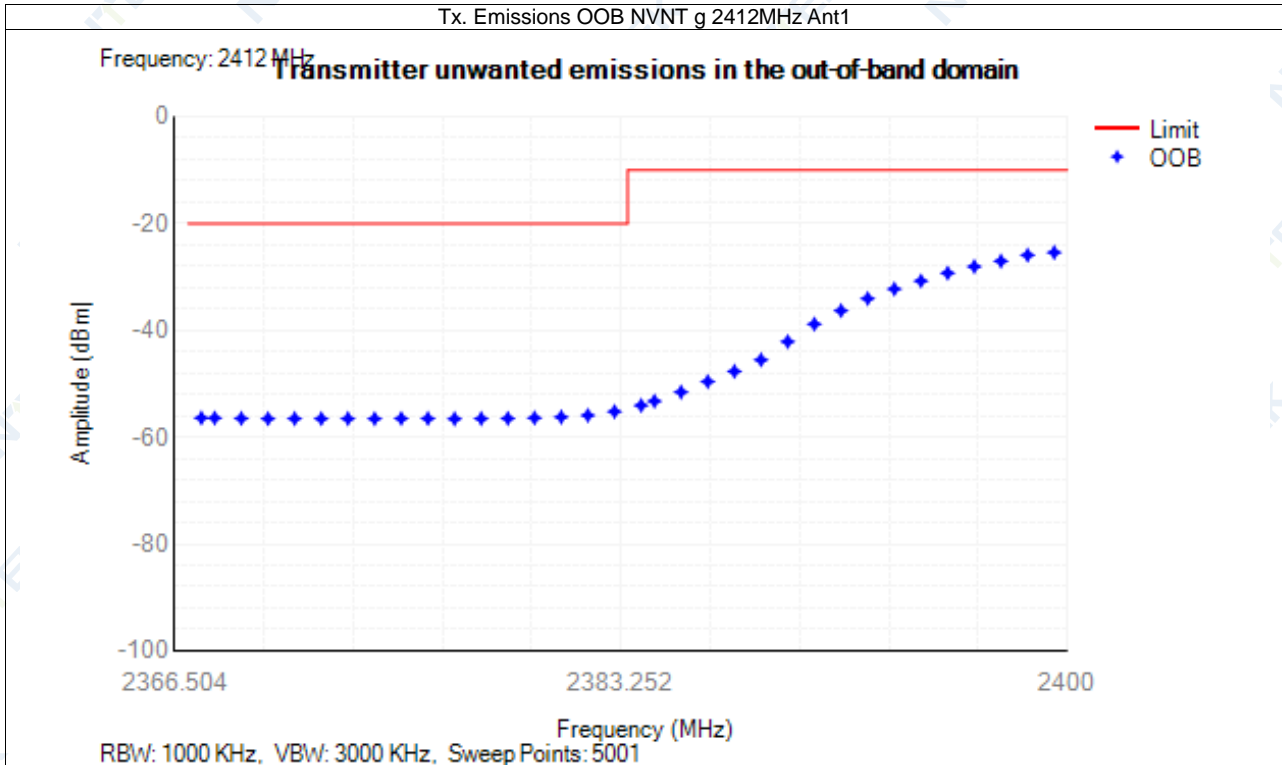

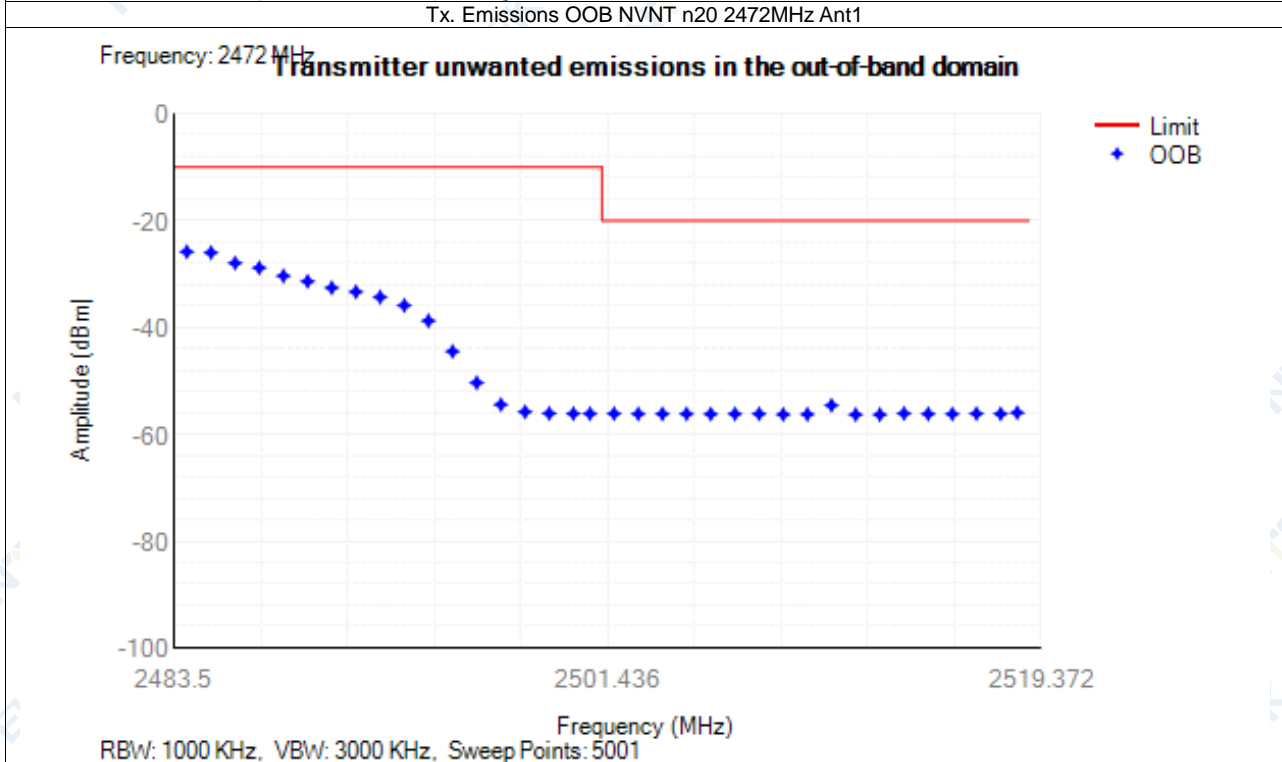
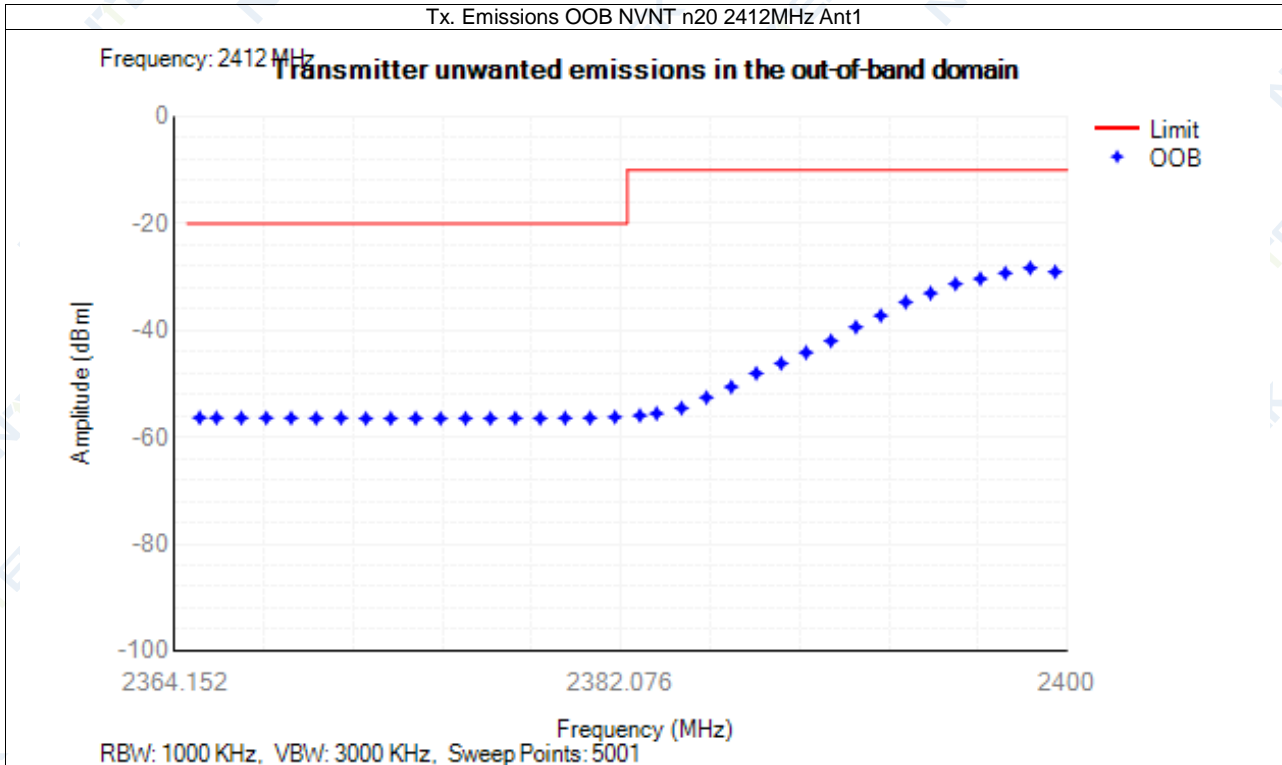

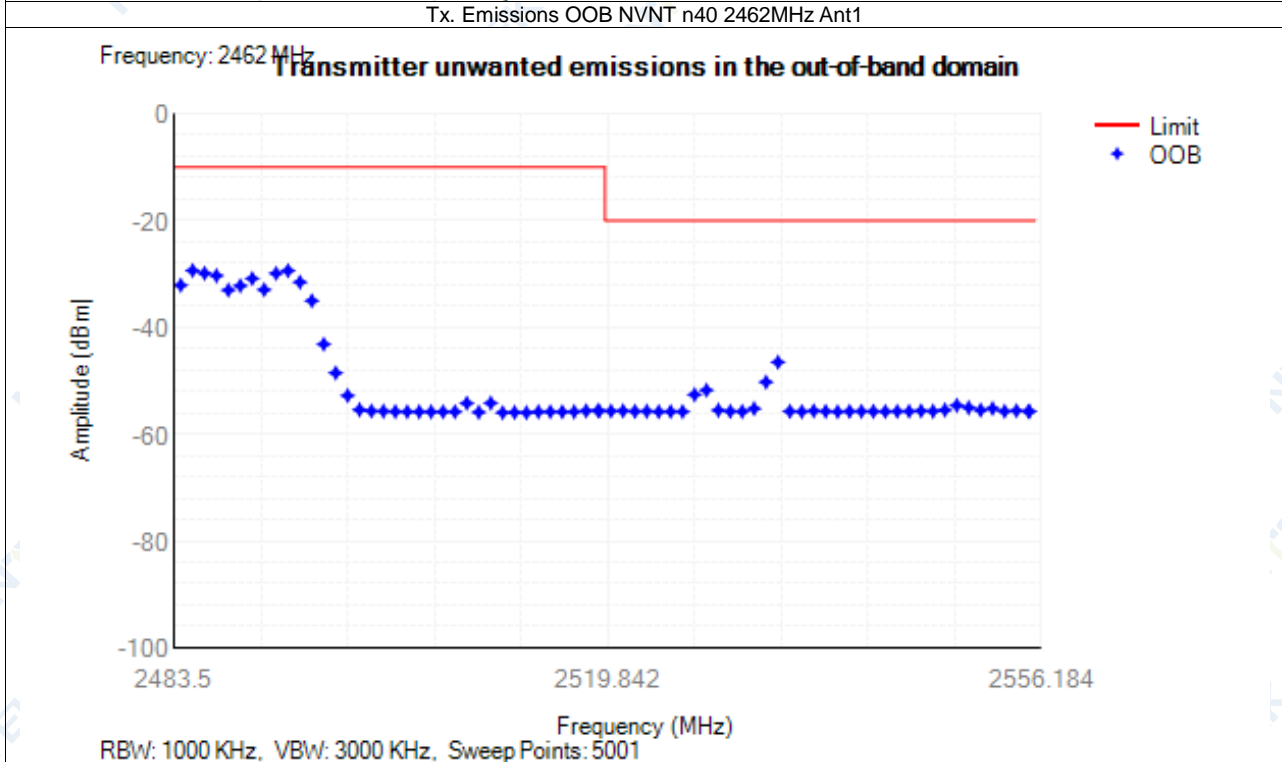
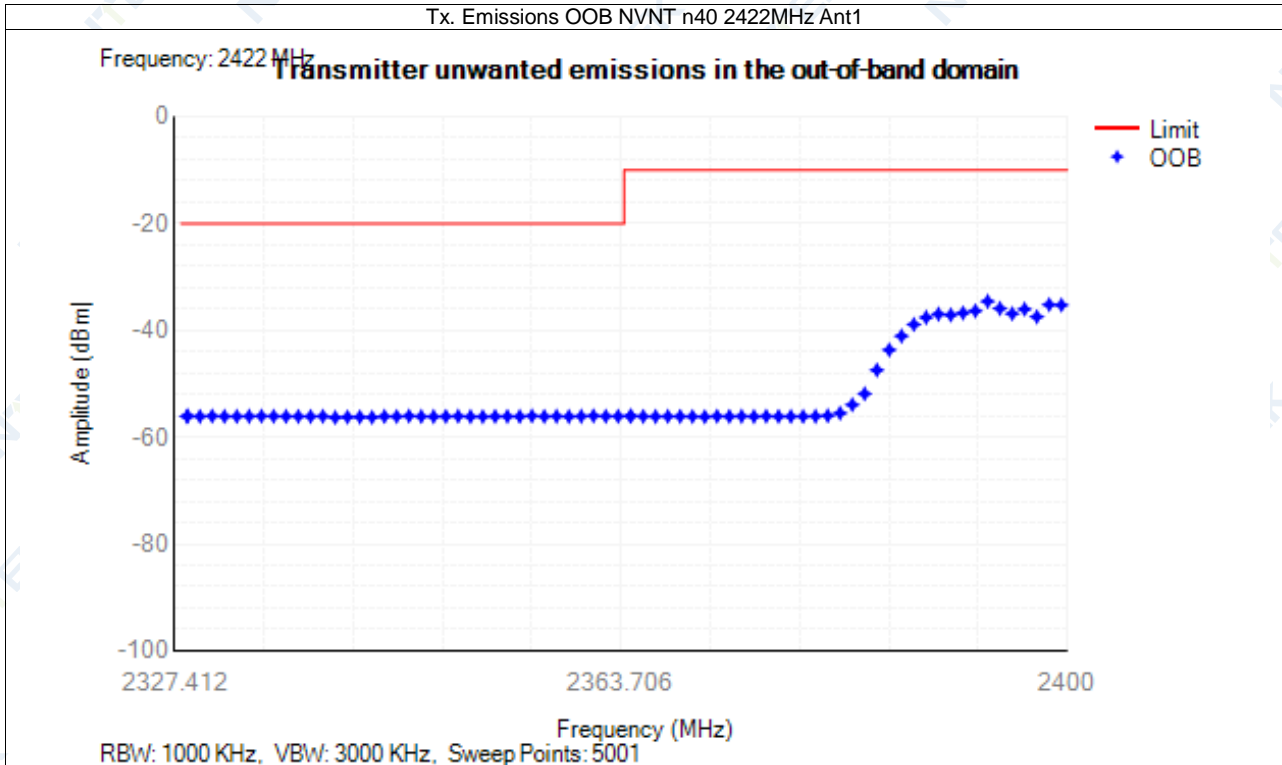

### 4.5 Transmitter unwanted emissions in the spurious domain

| Condition | Mode | Frequency (MHz) | Antenna | Range (MHz)   | Spur Freq (MHz) | Peak (dBm) | RMS (dBm) | Limit (dBm) | Verdict |
|-----------|------|-----------------|---------|---------------|-----------------|------------|-----------|-------------|---------|
| NVNT      | b    | 2412            | Ant1    | 30 -47        | 36.65           | -75.26     | NA        | -36         | Pass    |
| NVNT      | b    | 2412            | Ant1    | 47 -74        | 60.40           | -76.45     | NA        | -54         | Pass    |
| NVNT      | b    | 2412            | Ant1    | 74 -87.5      | 77.95           | -76.02     | NA        | -36         | Pass    |
| NVNT      | b    | 2412            | Ant1    | 87.5 -118     | 90.00           | -75.89     | NA        | -54         | Pass    |
| NVNT      | b    | 2412            | Ant1    | 118 -174      | 169.60          | -75.16     | NA        | -36         | Pass    |
| NVNT      | b    | 2412            | Ant1    | 174 -230      | 198.40          | -74.34     | NA        | -54         | Pass    |
| NVNT      | b    | 2412            | Ant1    | 230 -470      | 247.10          | -74.06     | NA        | -36         | Pass    |
| NVNT      | b    | 2412            | Ant1    | 470 -694      | 619.00          | -69.96     | NA        | -54         | Pass    |
| NVNT      | b    | 2412            | Ant1    | 694 -1000     | 982.55          | -72.48     | NA        | -36         | Pass    |
| NVNT      | b    | 2412            | Ant1    | 1000 -2360    | 2189.50         | -53.28     | NA        | -30         | Pass    |
| NVNT      | b    | 2412            | Ant1    | 2523.5 -12750 | 6878.50         | -43.75     | NA        | -30         | Pass    |
| NVNT      | b    | 2442            | Ant1    | 30 -47        | 45.40           | -76.01     | NA        | -36         | Pass    |
| NVNT      | b    | 2442            | Ant1    | 47 -74        | 69.75           | -76.21     | NA        | -54         | Pass    |
| NVNT      | b    | 2442            | Ant1    | 74 -87.5      | 79.00           | -76.25     | NA        | -36         | Pass    |
| NVNT      | b    | 2442            | Ant1    | 87.5 -118     | 102.50          | -75.73     | NA        | -54         | Pass    |
| NVNT      | b    | 2442            | Ant1    | 118 -174      | 129.30          | -75.62     | NA        | -36         | Pass    |
| NVNT      | b    | 2442            | Ant1    | 174 -230      | 184.55          | -74.32     | NA        | -54         | Pass    |
| NVNT      | b    | 2442            | Ant1    | 230 -470      | 432.25          | -73.85     | NA        | -36         | Pass    |
| NVNT      | b    | 2442            | Ant1    | 470 -694      | 679.05          | -71.87     | NA        | -54         | Pass    |
| NVNT      | b    | 2442            | Ant1    | 694 -1000     | 944.90          | -73.25     | NA        | -36         | Pass    |
| NVNT      | b    | 2442            | Ant1    | 1000 -2360    | 1814.50         | -53.07     | NA        | -30         | Pass    |
| NVNT      | b    | 2442            | Ant1    | 2523.5 -12750 | 6978.50         | -44.71     | NA        | -30         | Pass    |
| NVNT      | b    | 2472            | Ant1    | 30 -47        | 32.45           | -76.53     | NA        | -36         | Pass    |
| NVNT      | b    | 2472            | Ant1    | 47 -74        | 68.40           | -75.51     | NA        | -54         | Pass    |
| NVNT      | b    | 2472            | Ant1    | 74 -87.5      | 80.25           | -76.58     | NA        | -36         | Pass    |
| NVNT      | b    | 2472            | Ant1    | 87.5 -118     | 97.30           | -76.25     | NA        | -54         | Pass    |
| NVNT      | b    | 2472            | Ant1    | 118 -174      | 146.75          | -75.17     | NA        | -36         | Pass    |
| NVNT      | b    | 2472            | Ant1    | 174 -230      | 190.95          | -74.35     | NA        | -54         | Pass    |
| NVNT      | b    | 2472            | Ant1    | 230 -470      | 257.85          | -73.71     | NA        | -36         | Pass    |
| NVNT      | b    | 2472            | Ant1    | 470 -694      | 595.40          | -74.31     | NA        | -54         | Pass    |
| NVNT      | b    | 2472            | Ant1    | 694 -1000     | 739.00          | -72.56     | NA        | -36         | Pass    |
| NVNT      | b    | 2472            | Ant1    | 1000 -2360    | 2221.50         | -53.16     | NA        | -30         | Pass    |
| NVNT      | b    | 2472            | Ant1    | 2523.5 -12750 | 4944.00         | -44.24     | NA        | -30         | Pass    |
| NVNT      | g    | 2412            | Ant1    | 30 -47        | 33.30           | -76.15     | NA        | -36         | Pass    |
| NVNT      | g    | 2412            | Ant1    | 47 -74        | 59.70           | -76.21     | NA        | -54         | Pass    |
| NVNT      | g    | 2412            | Ant1    | 74 -87.5      | 74.65           | -75.23     | NA        | -36         | Pass    |
| NVNT      | g    | 2412            | Ant1    | 87.5 -118     | 114.90          | -75.57     | NA        | -54         | Pass    |
| NVNT      | g    | 2412            | Ant1    | 118 -174      | 160.85          | -75.52     | NA        | -36         | Pass    |
| NVNT      | g    | 2412            | Ant1    | 174 -230      | 185.40          | -74.46     | NA        | -54         | Pass    |
| NVNT      | g    | 2412            | Ant1    | 230 -470      | 448.95          | -74.48     | NA        | -36         | Pass    |
| NVNT      | g    | 2412            | Ant1    | 470 -694      | 488.40          | -74.36     | NA        | -54         | Pass    |
| NVNT      | g    | 2412            | Ant1    | 694 -1000     | 959.25          | -72.99     | NA        | -36         | Pass    |
| NVNT      | g    | 2412            | Ant1    | 1000 -2360    | 2256.00         | -52.61     | NA        | -30         | Pass    |
| NVNT      | g    | 2412            | Ant1    | 2523.5 -12750 | 6990.50         | -44.24     | NA        | -30         | Pass    |
| NVNT      | g    | 2442            | Ant1    | 30 -47        | 45.95           | -76.28     | NA        | -36         | Pass    |
| NVNT      | g    | 2442            | Ant1    | 47 -74        | 62.55           | -76.37     | NA        | -54         | Pass    |
| NVNT      | g    | 2442            | Ant1    | 74 -87.5      | 84.05           | -76.01     | NA        | -36         | Pass    |
| NVNT      | g    | 2442            | Ant1    | 87.5 -118     | 105.95          | -75.83     | NA        | -54         | Pass    |
| NVNT      | g    | 2442            | Ant1    | 118 -174      | 165.15          | -75.35     | NA        | -36         | Pass    |
| NVNT      | g    | 2442            | Ant1    | 174 -230      | 192.55          | -74.59     | NA        | -54         | Pass    |
| NVNT      | g    | 2442            | Ant1    | 230 -470      | 395.90          | -74.53     | NA        | -36         | Pass    |
| NVNT      | g    | 2442            | Ant1    | 470 -694      | 591.15          | -74.13     | NA        | -54         | Pass    |
| NVNT      | g    | 2442            | Ant1    | 694 -1000     | 999.55          | -73.27     | NA        | -36         | Pass    |
| NVNT      | g    | 2442            | Ant1    | 1000 -2360    | 2195.00         | -52.52     | NA        | -30         | Pass    |
| NVNT      | g    | 2442            | Ant1    | 2523.5 -12750 | 6916.00         | -45.07     | NA        | -30         | Pass    |
| NVNT      | g    | 2472            | Ant1    | 30 -47        | 34.40           | -75.88     | NA        | -36         | Pass    |
| NVNT      | g    | 2472            | Ant1    | 47 -74        | 47.90           | -75.85     | NA        | -54         | Pass    |
| NVNT      | g    | 2472            | Ant1    | 74 -87.5      | 79.25           | -75.77     | NA        | -36         | Pass    |
| NVNT      | g    | 2472            | Ant1    | 87.5 -118     | 101.15          | -75.71     | NA        | -54         | Pass    |
| NVNT      | g    | 2472            | Ant1    | 118 -174      | 163.95          | -74.89     | NA        | -36         | Pass    |
| NVNT      | g    | 2472            | Ant1    | 174 -230      | 203.05          | -75.06     | NA        | -54         | Pass    |
| NVNT      | g    | 2472            | Ant1    | 230 -470      | 366.30          | -74.44     | NA        | -36         | Pass    |
| NVNT      | g    | 2472            | Ant1    | 470 -694      | 615.90          | -73.88     | NA        | -54         | Pass    |
| NVNT      | g    | 2472            | Ant1    | 694 -1000     | 953.10          | -74.21     | NA        | -36         | Pass    |
| NVNT      | g    | 2472            | Ant1    | 1000 -2360    | 1667.00         | -52.67     | NA        | -30         | Pass    |
| NVNT      | g    | 2472            | Ant1    | 2523.5 -12750 | 6960.00         | -44.93     | NA        | -30         | Pass    |
| NVNT      | n20  | 2412            | Ant1    | 30 -47        | 39.20           | -75.72     | NA        | -36         | Pass    |
| NVNT      | n20  | 2412            | Ant1    | 47 -74        | 71.80           | -75.92     | NA        | -54         | Pass    |
| NVNT      | n20  | 2412            | Ant1    | 74 -87.5      | 80.05           | -76.14     | NA        | -36         | Pass    |
| NVNT      | n20  | 2412            | Ant1    | 87.5 -118     | 111.85          | -75.85     | NA        | -54         | Pass    |
| NVNT      | n20  | 2412            | Ant1    | 118 -174      | 173.10          | -75.48     | NA        | -36         | Pass    |

|      |     |      |      |               |         |        |    |     |      |
|------|-----|------|------|---------------|---------|--------|----|-----|------|
| NVNT | n20 | 2412 | Ant1 | 174 -230      | 177.00  | -74.00 | NA | -54 | Pass |
| NVNT | n20 | 2412 | Ant1 | 230 -470      | 269.15  | -74.42 | NA | -36 | Pass |
| NVNT | n20 | 2412 | Ant1 | 470 -694      | 495.45  | -74.46 | NA | -54 | Pass |
| NVNT | n20 | 2412 | Ant1 | 694 -1000     | 930.90  | -73.57 | NA | -36 | Pass |
| NVNT | n20 | 2412 | Ant1 | 1000 -2360    | 2330.00 | -52.86 | NA | -30 | Pass |
| NVNT | n20 | 2412 | Ant1 | 2523.5 -12750 | 6836.50 | -44.50 | NA | -30 | Pass |
| NVNT | n20 | 2442 | Ant1 | 30 -47        | 42.00   | -75.80 | NA | -36 | Pass |
| NVNT | n20 | 2442 | Ant1 | 47 -74        | 66.95   | -75.56 | NA | -54 | Pass |
| NVNT | n20 | 2442 | Ant1 | 74 -87.5      | 83.75   | -76.10 | NA | -36 | Pass |
| NVNT | n20 | 2442 | Ant1 | 87.5 -118     | 103.95  | -75.79 | NA | -54 | Pass |
| NVNT | n20 | 2442 | Ant1 | 118 -174      | 160.25  | -75.07 | NA | -36 | Pass |
| NVNT | n20 | 2442 | Ant1 | 174 -230      | 181.40  | -75.51 | NA | -54 | Pass |
| NVNT | n20 | 2442 | Ant1 | 230 -470      | 313.60  | -74.42 | NA | -36 | Pass |
| NVNT | n20 | 2442 | Ant1 | 470 -694      | 617.90  | -74.32 | NA | -54 | Pass |
| NVNT | n20 | 2442 | Ant1 | 694 -1000     | 995.35  | -73.57 | NA | -36 | Pass |
| NVNT | n20 | 2442 | Ant1 | 1000 -2360    | 2119.50 | -52.40 | NA | -30 | Pass |
| NVNT | n20 | 2442 | Ant1 | 2523.5 -12750 | 6708.50 | -44.42 | NA | -30 | Pass |
| NVNT | n20 | 2472 | Ant1 | 30 -47        | 43.65   | -76.12 | NA | -36 | Pass |
| NVNT | n20 | 2472 | Ant1 | 47 -74        | 64.90   | -75.81 | NA | -54 | Pass |
| NVNT | n20 | 2472 | Ant1 | 74 -87.5      | 81.95   | -76.10 | NA | -36 | Pass |
| NVNT | n20 | 2472 | Ant1 | 87.5 -118     | 88.00   | -76.06 | NA | -54 | Pass |
| NVNT | n20 | 2472 | Ant1 | 118 -174      | 163.75  | -74.54 | NA | -36 | Pass |
| NVNT | n20 | 2472 | Ant1 | 174 -230      | 219.15  | -75.17 | NA | -54 | Pass |
| NVNT | n20 | 2472 | Ant1 | 230 -470      | 352.45  | -74.33 | NA | -36 | Pass |
| NVNT | n20 | 2472 | Ant1 | 470 -694      | 581.15  | -73.99 | NA | -54 | Pass |
| NVNT | n20 | 2472 | Ant1 | 694 -1000     | 988.65  | -73.34 | NA | -36 | Pass |
| NVNT | n20 | 2472 | Ant1 | 1000 -2360    | 1670.50 | -53.51 | NA | -30 | Pass |
| NVNT | n20 | 2472 | Ant1 | 2523.5 -12750 | 6970.00 | -45.08 | NA | -30 | Pass |
| NVNT | n40 | 2422 | Ant1 | 30 -47        | 32.80   | -76.40 | NA | -36 | Pass |
| NVNT | n40 | 2422 | Ant1 | 47 -74        | 70.20   | -75.70 | NA | -54 | Pass |
| NVNT | n40 | 2422 | Ant1 | 74 -87.5      | 81.20   | -75.84 | NA | -36 | Pass |
| NVNT | n40 | 2422 | Ant1 | 87.5 -118     | 106.10  | -75.23 | NA | -54 | Pass |
| NVNT | n40 | 2422 | Ant1 | 118 -174      | 170.60  | -75.40 | NA | -36 | Pass |
| NVNT | n40 | 2422 | Ant1 | 174 -230      | 224.50  | -74.15 | NA | -54 | Pass |
| NVNT | n40 | 2422 | Ant1 | 230 -470      | 316.75  | -74.28 | NA | -36 | Pass |
| NVNT | n40 | 2422 | Ant1 | 470 -694      | 583.05  | -74.07 | NA | -54 | Pass |
| NVNT | n40 | 2422 | Ant1 | 694 -1000     | 933.60  | -74.04 | NA | -36 | Pass |
| NVNT | n40 | 2422 | Ant1 | 1000 -2320    | 1660.50 | -53.16 | NA | -30 | Pass |
| NVNT | n40 | 2422 | Ant1 | 2563.5 -12750 | 6972.00 | -44.65 | NA | -30 | Pass |
| NVNT | n40 | 2442 | Ant1 | 30 -47        | 31.30   | -75.31 | NA | -36 | Pass |
| NVNT | n40 | 2442 | Ant1 | 47 -74        | 65.85   | -75.31 | NA | -54 | Pass |
| NVNT | n40 | 2442 | Ant1 | 74 -87.5      | 83.85   | -76.14 | NA | -36 | Pass |
| NVNT | n40 | 2442 | Ant1 | 87.5 -118     | 92.80   | -75.38 | NA | -54 | Pass |
| NVNT | n40 | 2442 | Ant1 | 118 -174      | 172.35  | -74.46 | NA | -36 | Pass |
| NVNT | n40 | 2442 | Ant1 | 174 -230      | 201.50  | -74.96 | NA | -54 | Pass |
| NVNT | n40 | 2442 | Ant1 | 230 -470      | 333.60  | -74.21 | NA | -36 | Pass |
| NVNT | n40 | 2442 | Ant1 | 470 -694      | 678.80  | -74.01 | NA | -54 | Pass |
| NVNT | n40 | 2442 | Ant1 | 694 -1000     | 970.45  | -73.54 | NA | -36 | Pass |
| NVNT | n40 | 2442 | Ant1 | 1000 -2320    | 2294.50 | -52.72 | NA | -30 | Pass |
| NVNT | n40 | 2442 | Ant1 | 2563.5 -12750 | 6649.00 | -45.04 | NA | -30 | Pass |
| NVNT | n40 | 2462 | Ant1 | 30 -47        | 30.05   | -75.44 | NA | -36 | Pass |
| NVNT | n40 | 2462 | Ant1 | 47 -74        | 55.10   | -75.84 | NA | -54 | Pass |
| NVNT | n40 | 2462 | Ant1 | 74 -87.5      | 87.30   | -76.67 | NA | -36 | Pass |
| NVNT | n40 | 2462 | Ant1 | 87.5 -118     | 116.80  | -74.40 | NA | -54 | Pass |
| NVNT | n40 | 2462 | Ant1 | 118 -174      | 172.80  | -74.77 | NA | -36 | Pass |
| NVNT | n40 | 2462 | Ant1 | 174 -230      | 209.25  | -74.39 | NA | -54 | Pass |
| NVNT | n40 | 2462 | Ant1 | 230 -470      | 347.95  | -74.14 | NA | -36 | Pass |
| NVNT | n40 | 2462 | Ant1 | 470 -694      | 489.20  | -74.32 | NA | -54 | Pass |
| NVNT | n40 | 2462 | Ant1 | 694 -1000     | 910.30  | -71.53 | NA | -36 | Pass |
| NVNT | n40 | 2462 | Ant1 | 1000 -2320    | 2149.00 | -52.95 | NA | -30 | Pass |
| NVNT | n40 | 2462 | Ant1 | 2563.5 -12750 | 6986.00 | -45.09 | NA | -30 | Pass |



Test Graphs  
Tx. Spurious NVNT b 2412MHz Ant1

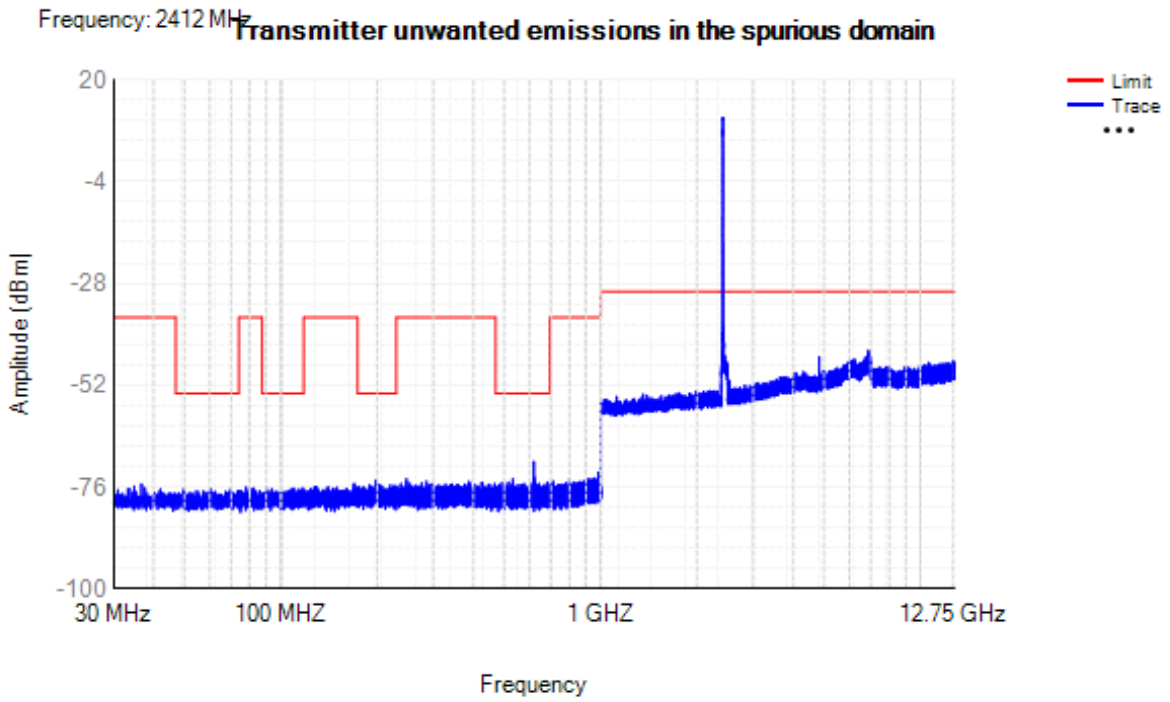

Tx. Spurious NVNT b 2442MHz Ant1

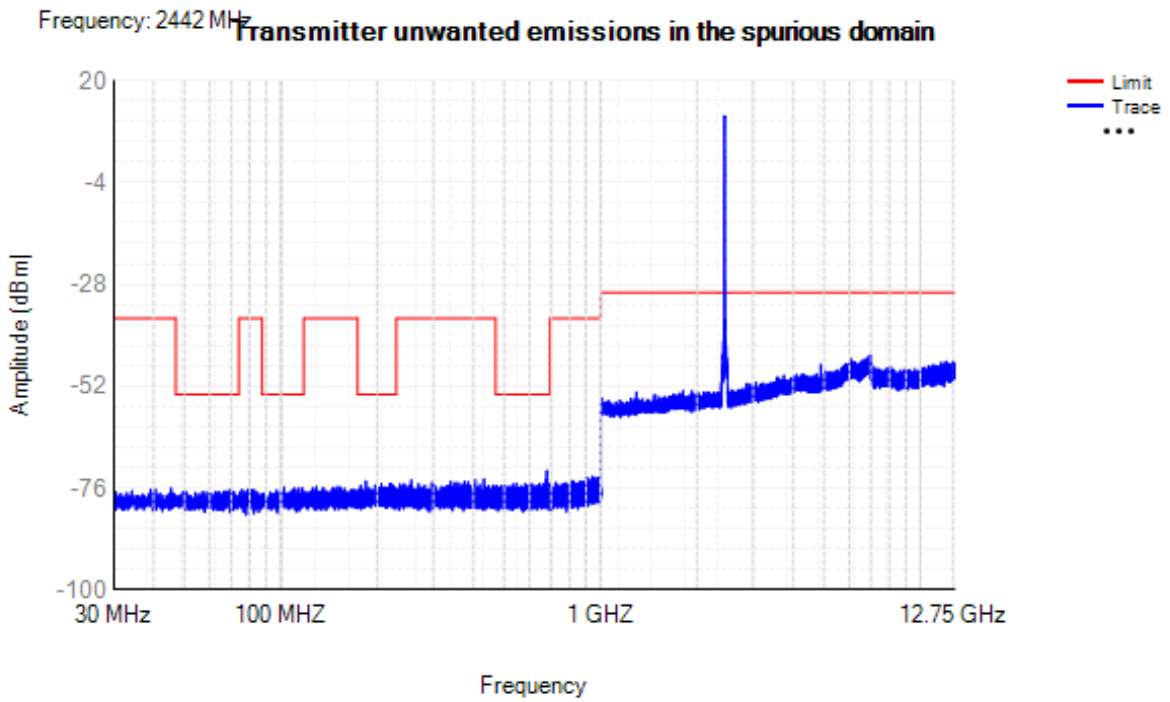

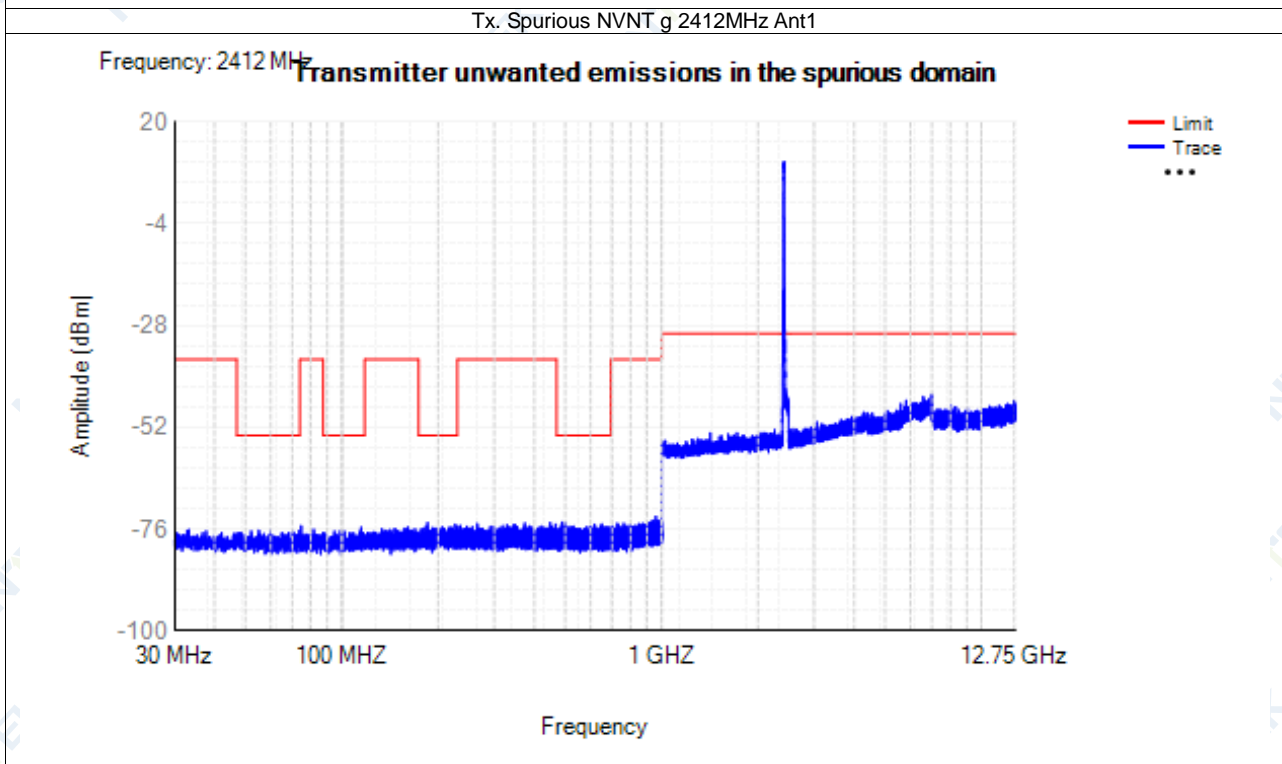
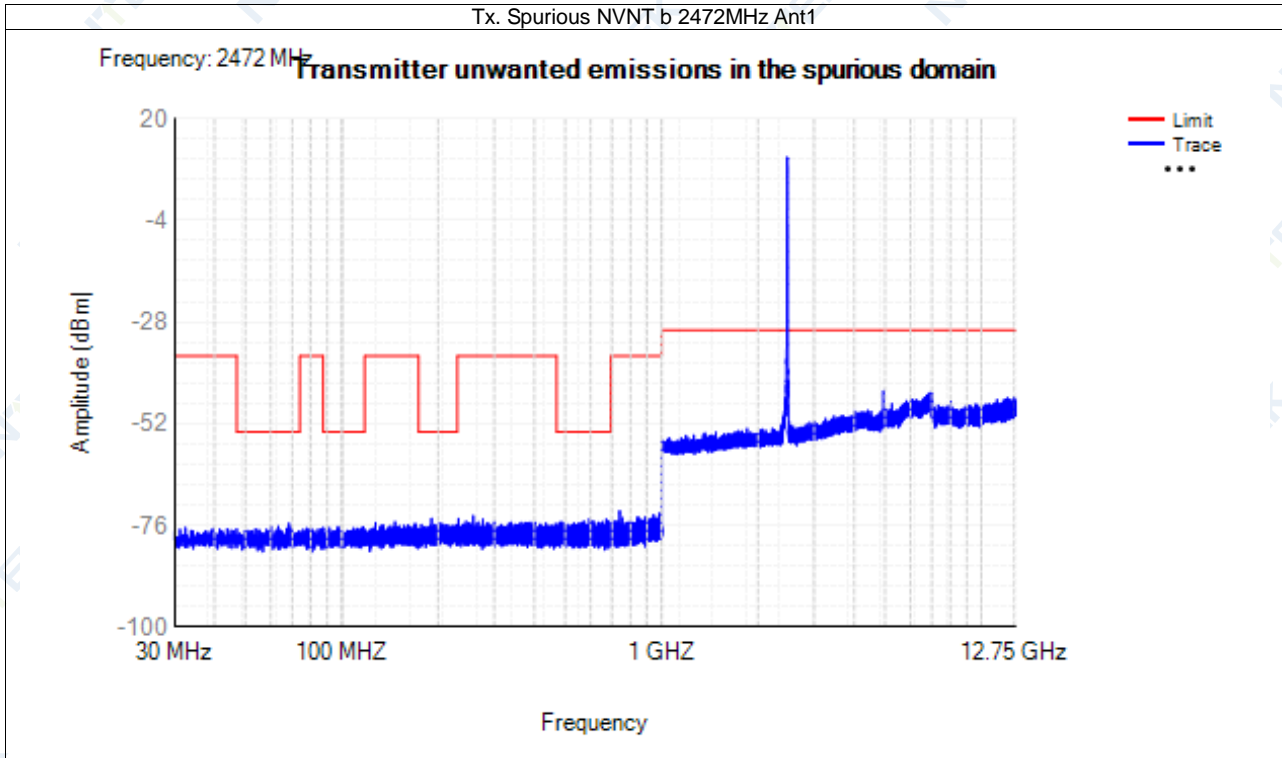



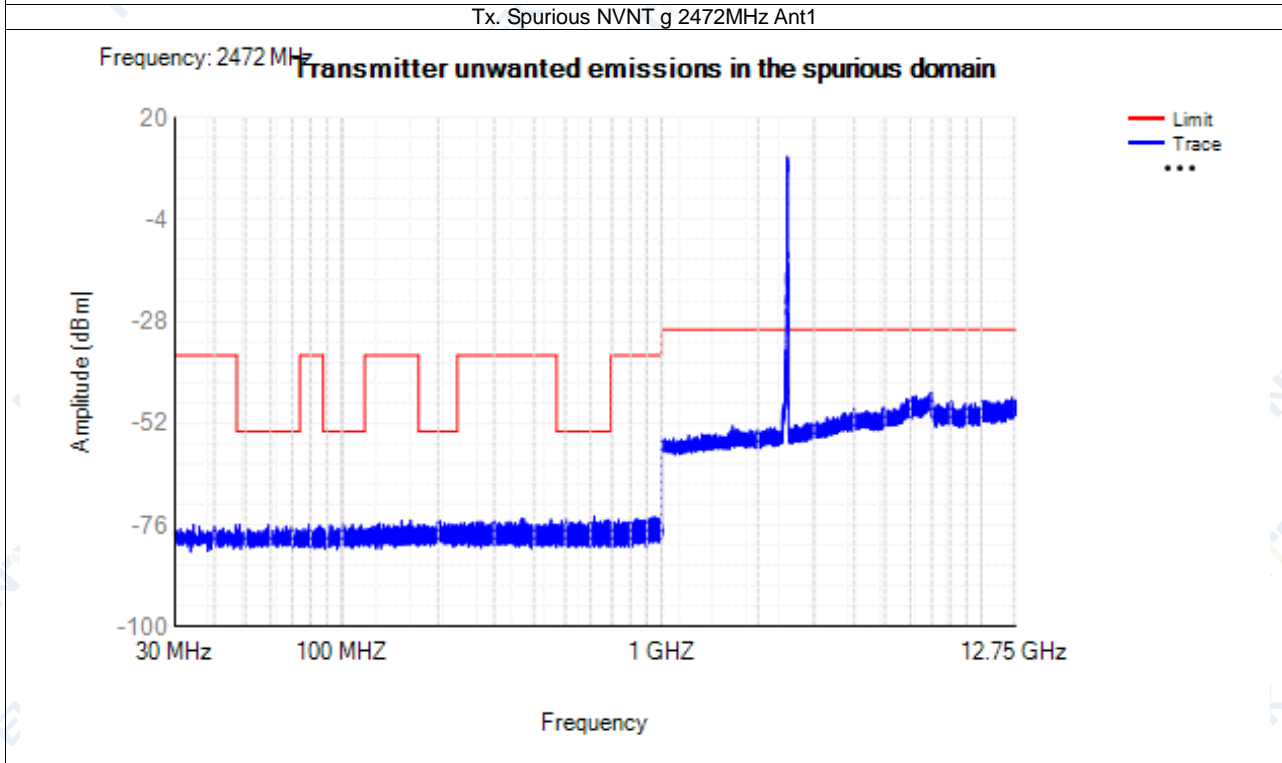
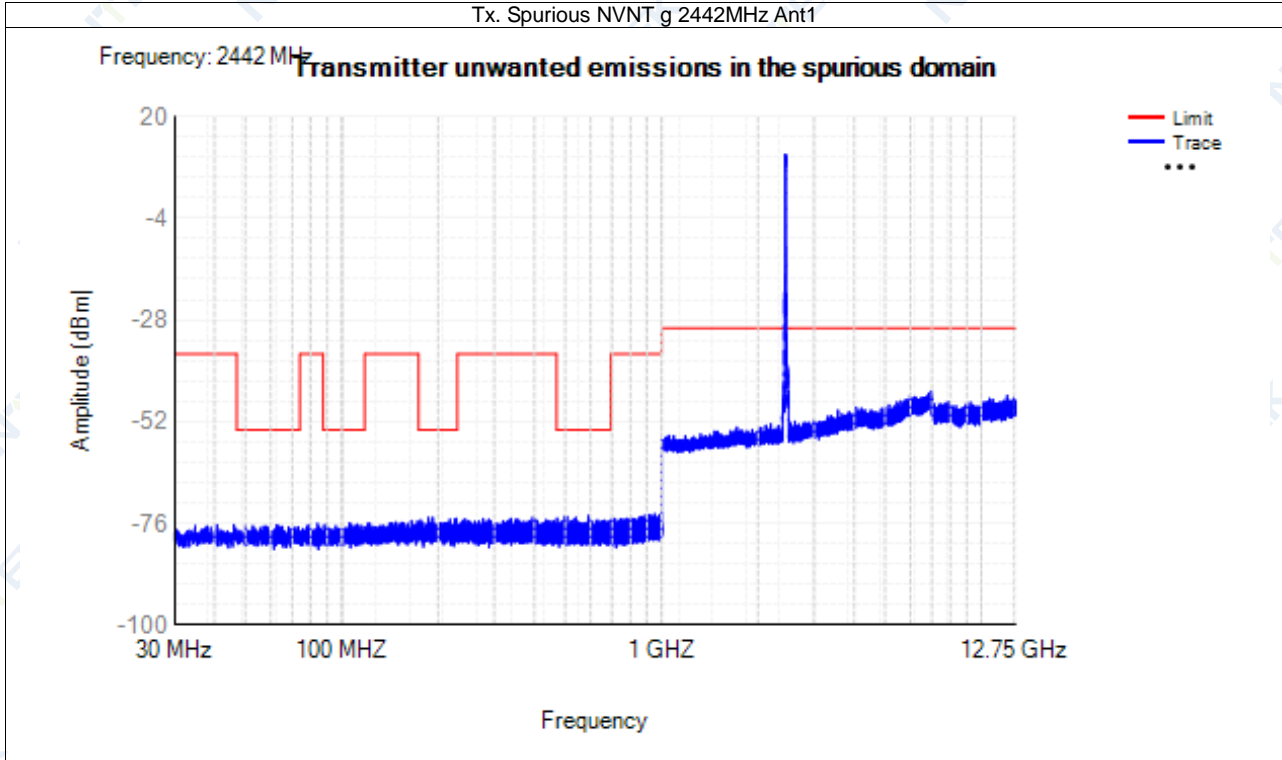

Tx. Spurious NVNT n20 2412MHz Ant1

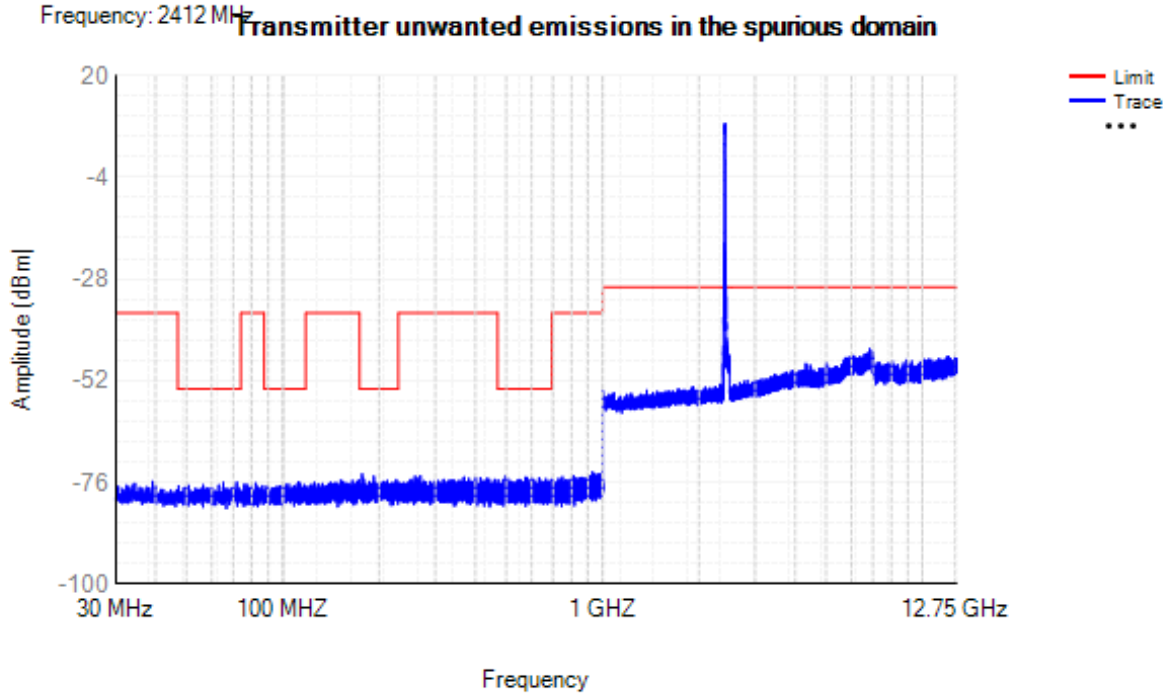

Tx. Spurious NVNT n20 2442MHz Ant1

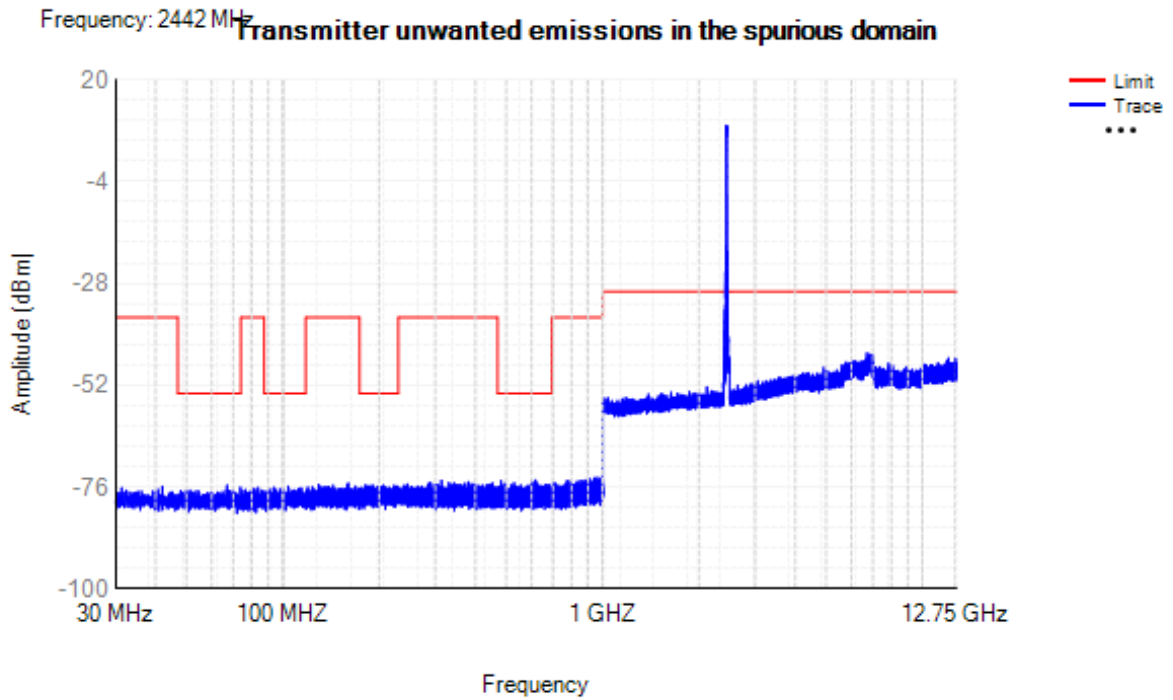

Tx. Spurious NVNT n20 2472MHz Ant1

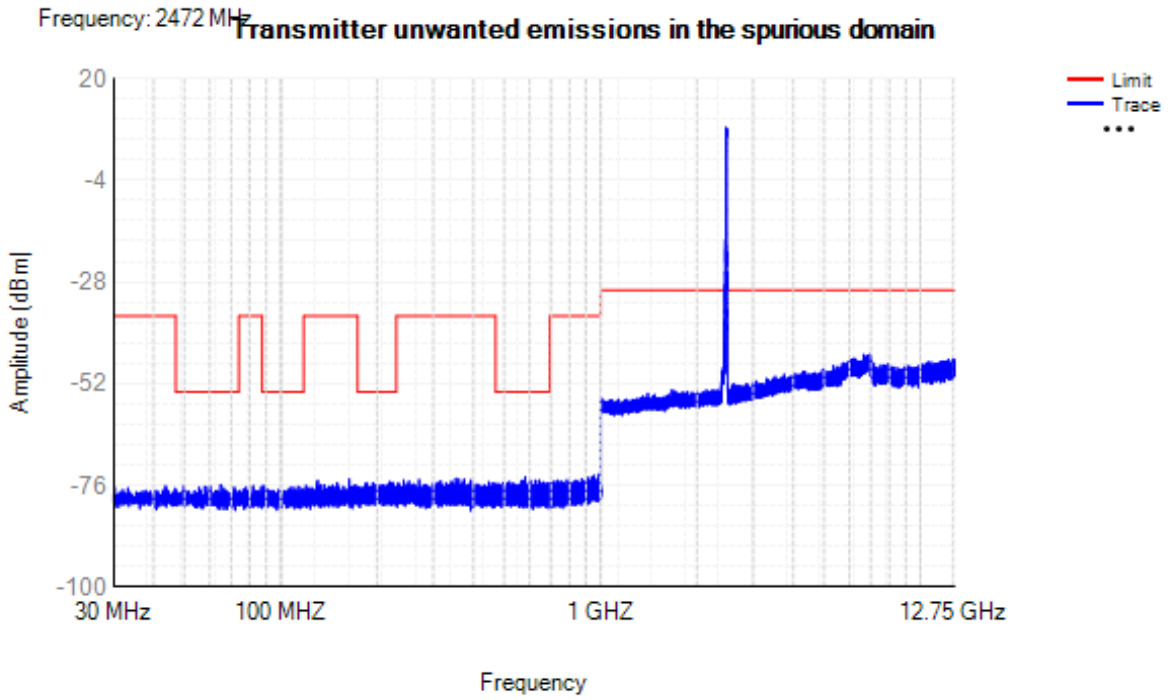

Tx. Spurious NVNT n40 2422MHz Ant1

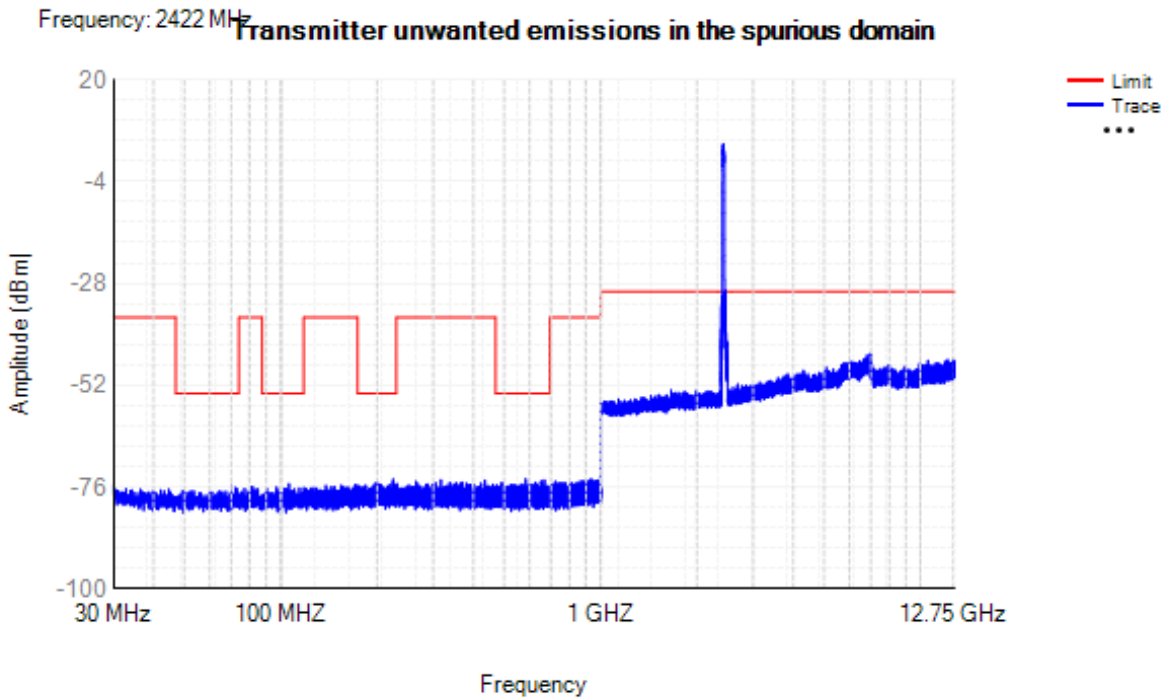

Tx. Spurious NVNT n40 2442MHz Ant1

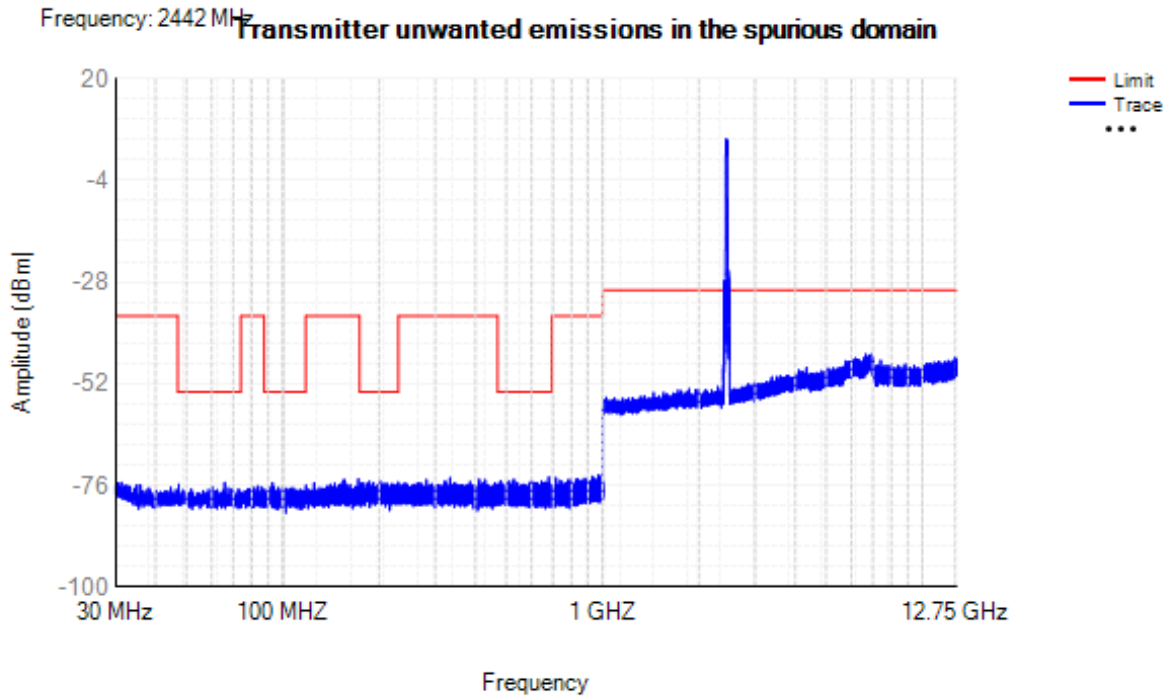

Tx. Spurious NVNT n40 2462MHz Ant1

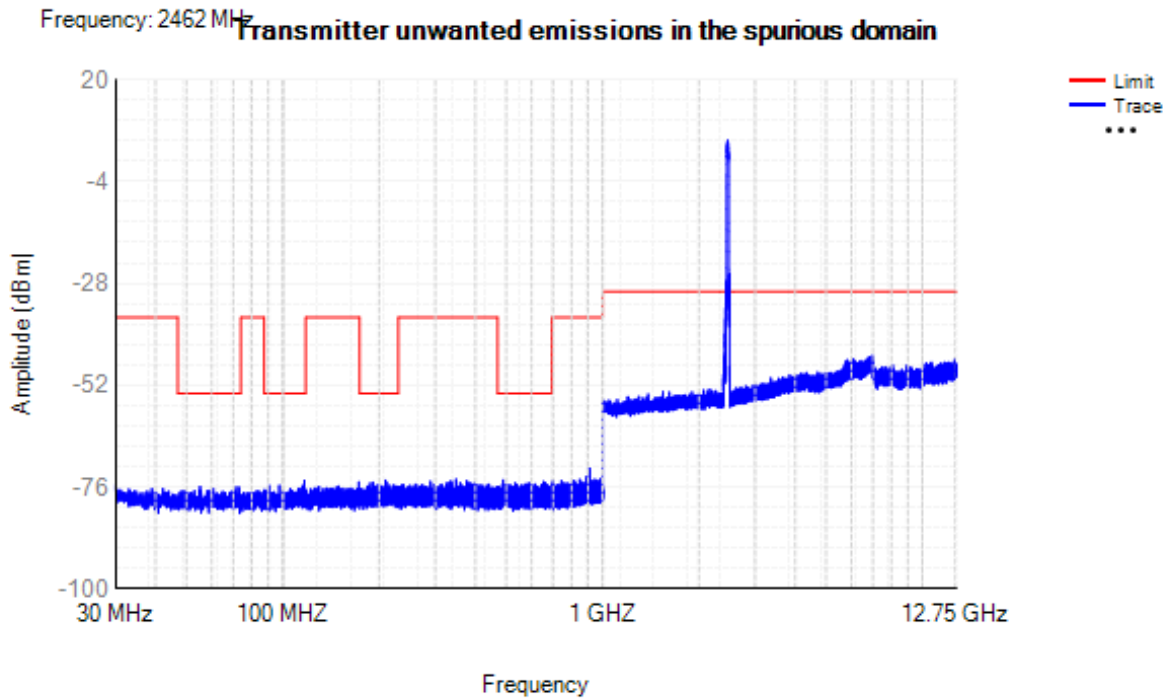

#### 4.6 Receiver spurious emissions

| Condition | Mode | Frequency (MHz) | Antenna | Range (MHz) | Spur Freq (MHz) | Peak (dBm) | RMS (dBm) | Limit (dBm) | Verdict |
|-----------|------|-----------------|---------|-------------|-----------------|------------|-----------|-------------|---------|
| NVNT      | b    | 2412            | Ant1    | 30 -1000    | 406.45          | -74.62     | NA        | -57         | Pass    |
| NVNT      | b    | 2412            | Ant1    | 1000 -12750 | 6846.5          | -54.73     | NA        | -47         | Pass    |
| NVNT      | b    | 2442            | Ant1    | 30 -1000    | 577.9           | -74.71     | NA        | -57         | Pass    |
| NVNT      | b    | 2442            | Ant1    | 1000 -12750 | 6961.5          | -55.67     | NA        | -47         | Pass    |
| NVNT      | b    | 2472            | Ant1    | 30 -1000    | 951.75          | -73.43     | NA        | -57         | Pass    |
| NVNT      | b    | 2472            | Ant1    | 1000 -12750 | 6950            | -55.16     | NA        | -47         | Pass    |
| NVNT      | g    | 2412            | Ant1    | 30 -1000    | 610.05          | -73.81     | NA        | -57         | Pass    |
| NVNT      | g    | 2412            | Ant1    | 1000 -12750 | 6927            | -54.81     | NA        | -47         | Pass    |
| NVNT      | g    | 2442            | Ant1    | 30 -1000    | 982.5           | -75.09     | NA        | -57         | Pass    |
| NVNT      | g    | 2442            | Ant1    | 1000 -12750 | 6981            | -54.92     | NA        | -47         | Pass    |
| NVNT      | g    | 2472            | Ant1    | 30 -1000    | 992.3           | -74.47     | NA        | -57         | Pass    |
| NVNT      | g    | 2472            | Ant1    | 1000 -12750 | 6162            | -55.11     | NA        | -47         | Pass    |
| NVNT      | n20  | 2412            | Ant1    | 30 -1000    | 722.3           | -74.20     | NA        | -57         | Pass    |
| NVNT      | n20  | 2412            | Ant1    | 1000 -12750 | 6983            | -55.93     | NA        | -47         | Pass    |
| NVNT      | n20  | 2442            | Ant1    | 30 -1000    | 935.6           | -74.42     | NA        | -57         | Pass    |
| NVNT      | n20  | 2442            | Ant1    | 1000 -12750 | 6988            | -55.76     | NA        | -47         | Pass    |
| NVNT      | n20  | 2472            | Ant1    | 30 -1000    | 315.25          | -74.40     | NA        | -57         | Pass    |
| NVNT      | n20  | 2472            | Ant1    | 1000 -12750 | 6959.5          | -55.95     | NA        | -47         | Pass    |
| NVNT      | n40  | 2422            | Ant1    | 30 -1000    | 155             | -74.39     | NA        | -57         | Pass    |
| NVNT      | n40  | 2422            | Ant1    | 1000 -12750 | 6997.5          | -55.15     | NA        | -47         | Pass    |
| NVNT      | n40  | 2442            | Ant1    | 30 -1000    | 987.25          | -74.48     | NA        | -57         | Pass    |
| NVNT      | n40  | 2442            | Ant1    | 1000 -12750 | 6889            | -55.27     | NA        | -47         | Pass    |
| NVNT      | n40  | 2462            | Ant1    | 30 -1000    | 927.65          | -73.87     | NA        | -57         | Pass    |
| NVNT      | n40  | 2462            | Ant1    | 1000 -12750 | 6810.5          | -55.28     | NA        | -47         | Pass    |

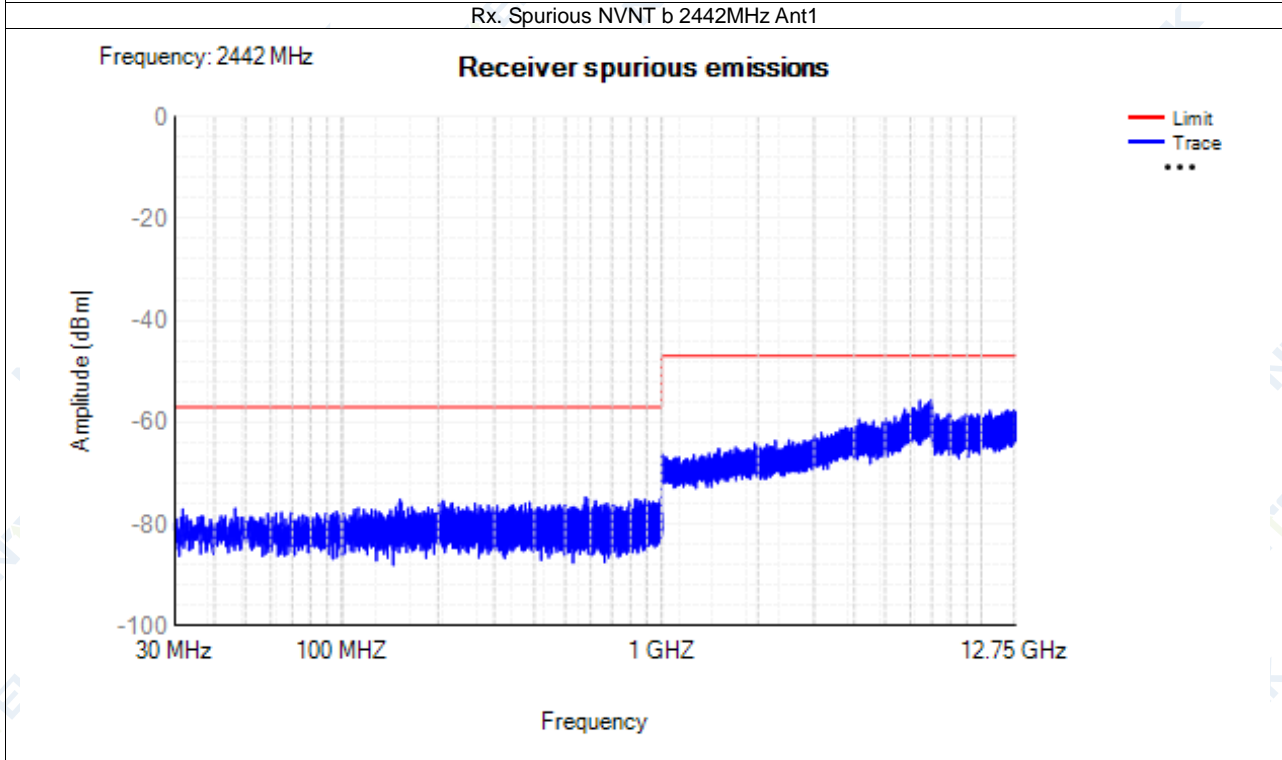
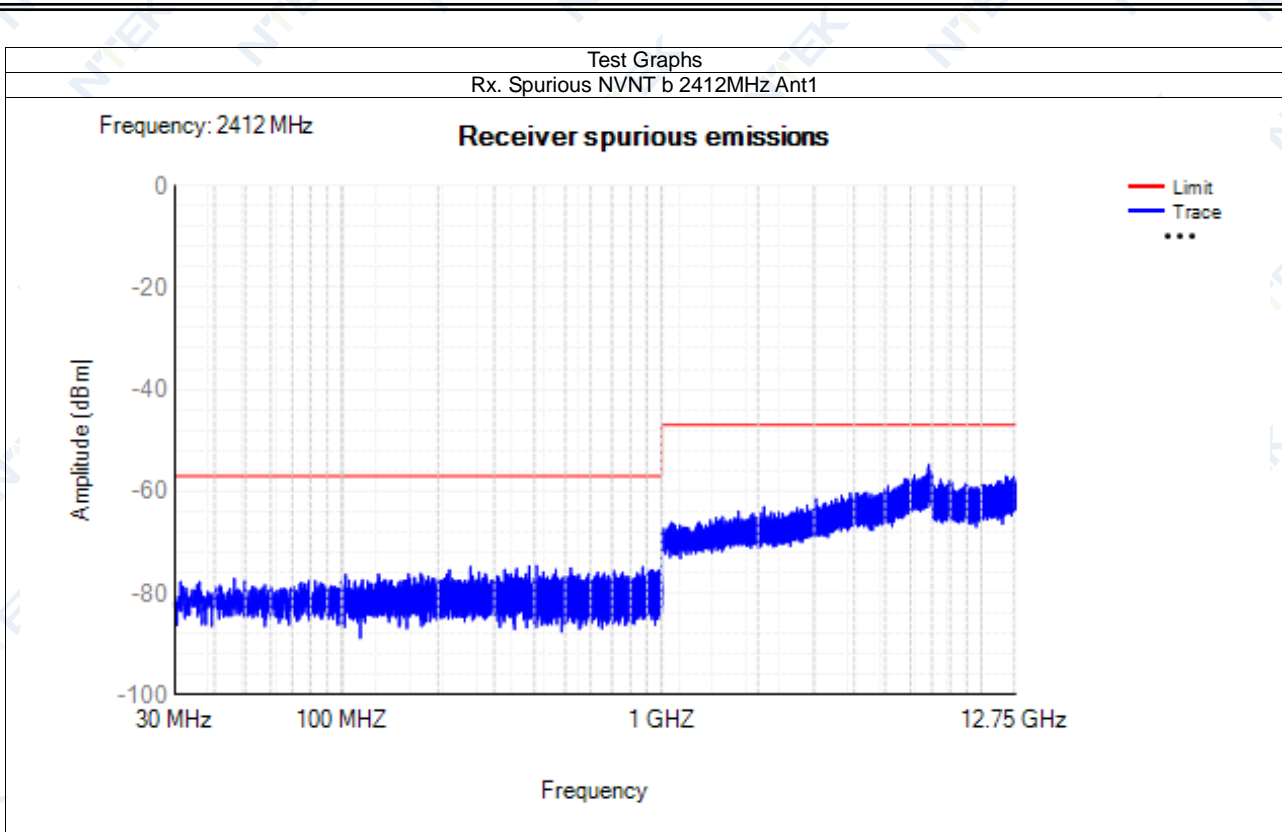



Rx. Spurious NVNT b 2472MHz Ant1

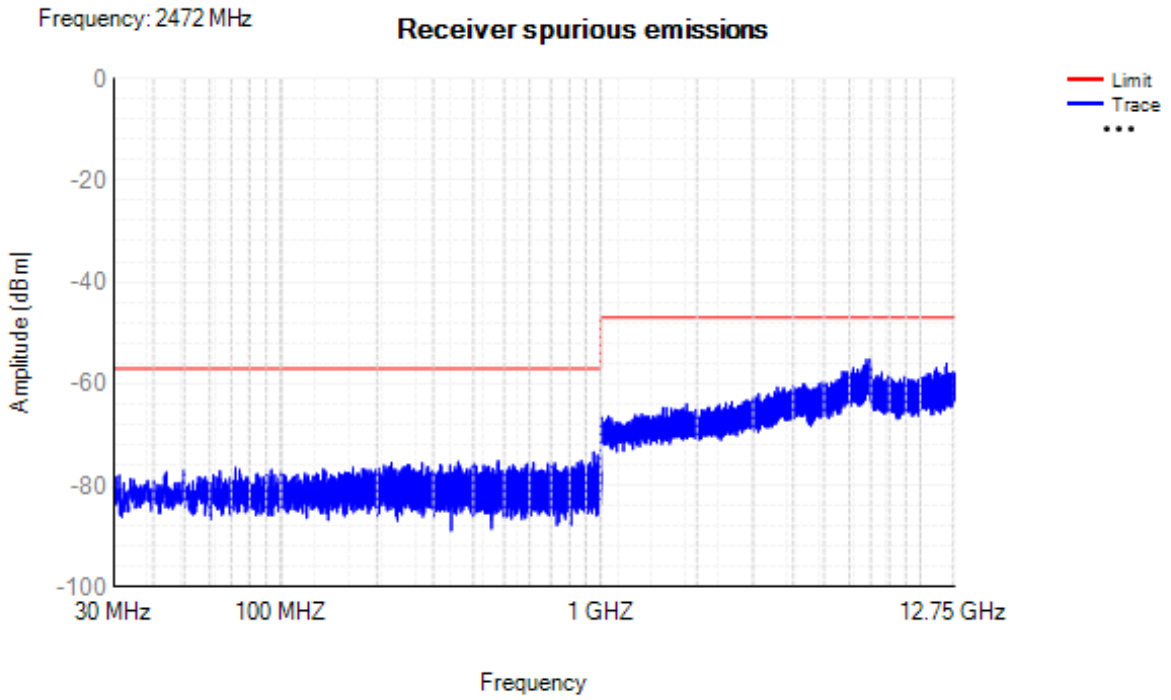

Rx. Spurious NVNT g 2412MHz Ant1

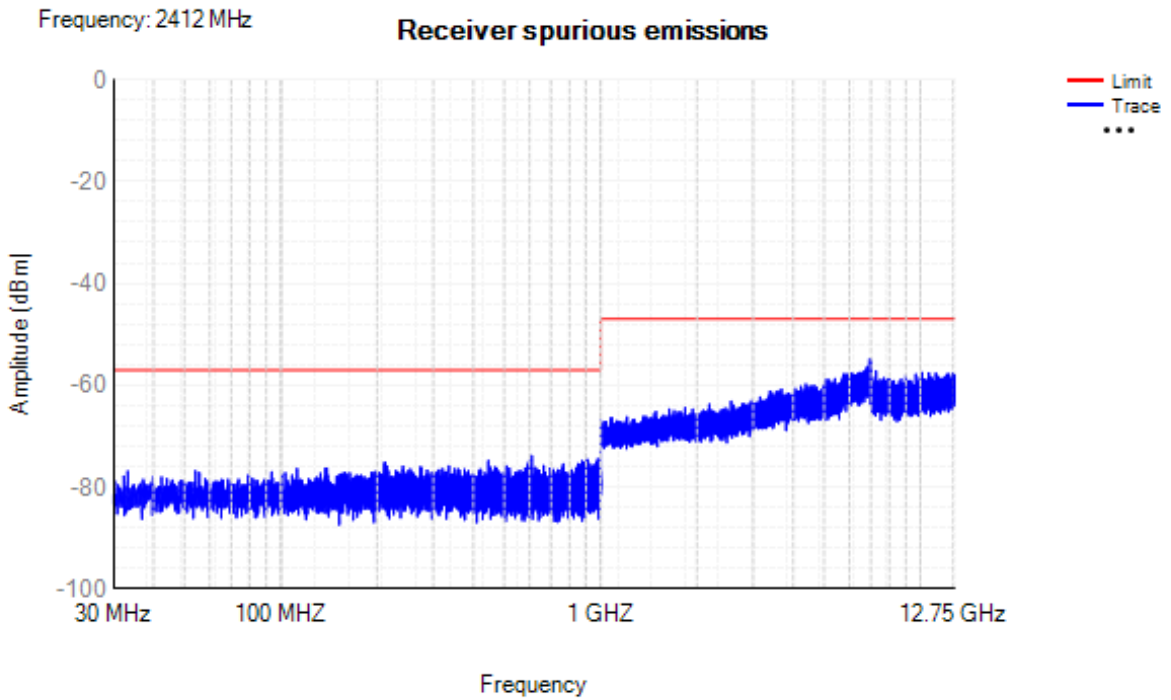



Rx. Spurious NVNT g 2442MHz Ant1

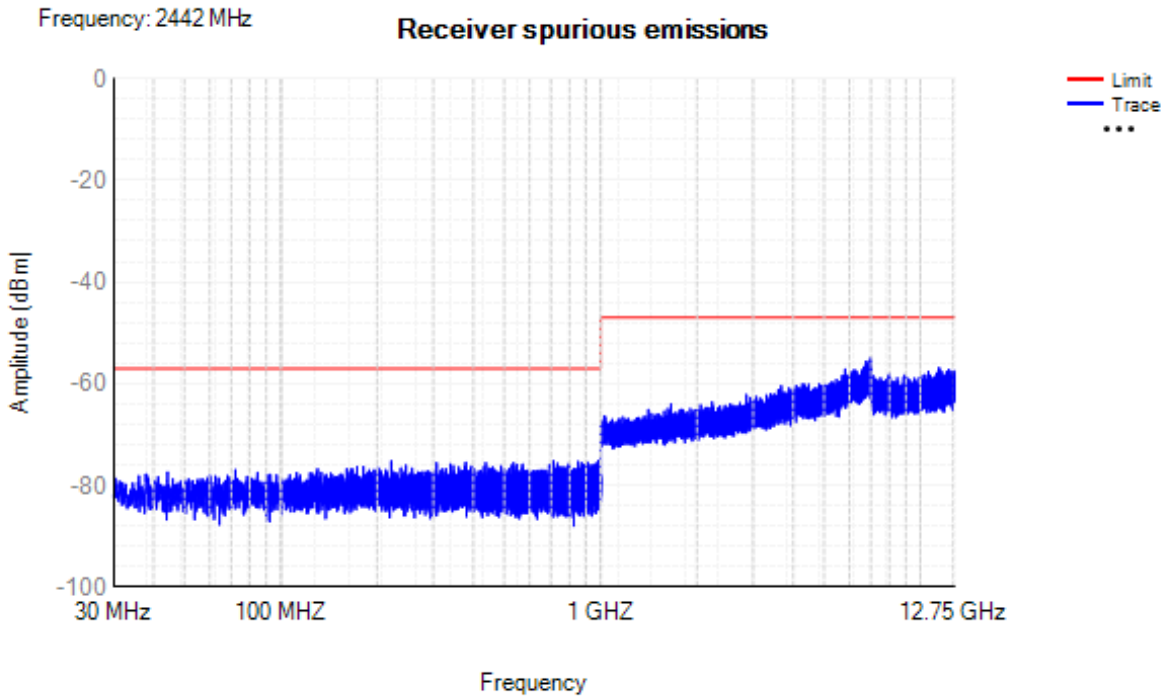

Rx. Spurious NVNT g 2472MHz Ant1

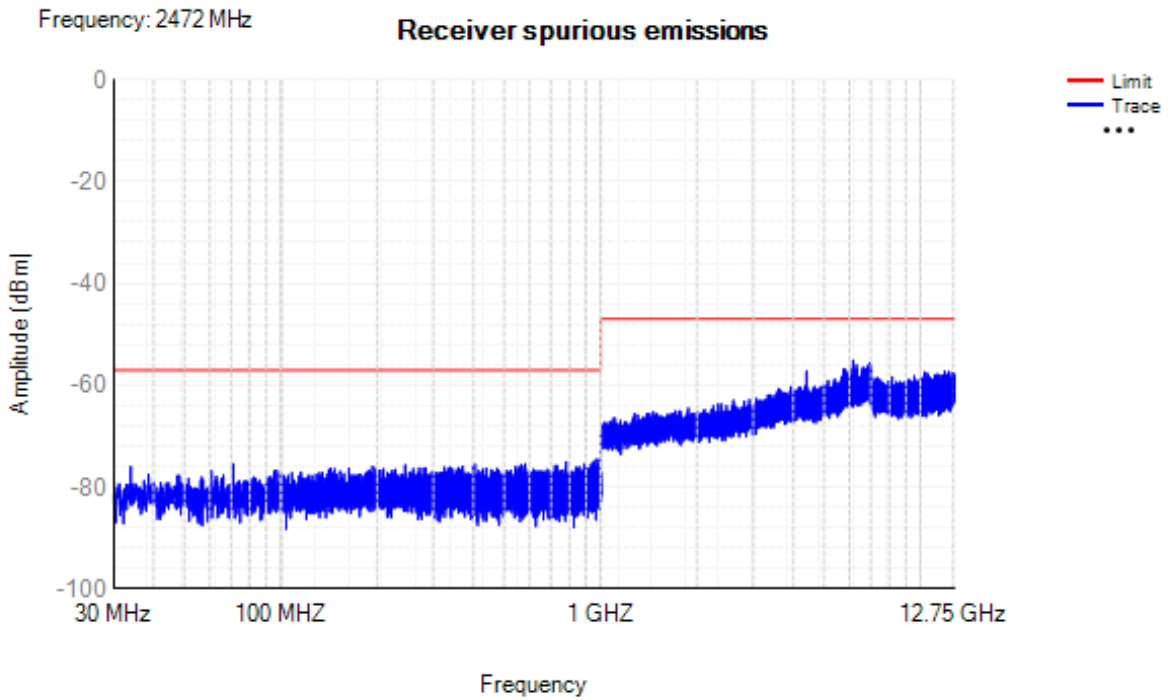

Rx. Spurious NVNT n20 2412MHz Ant1

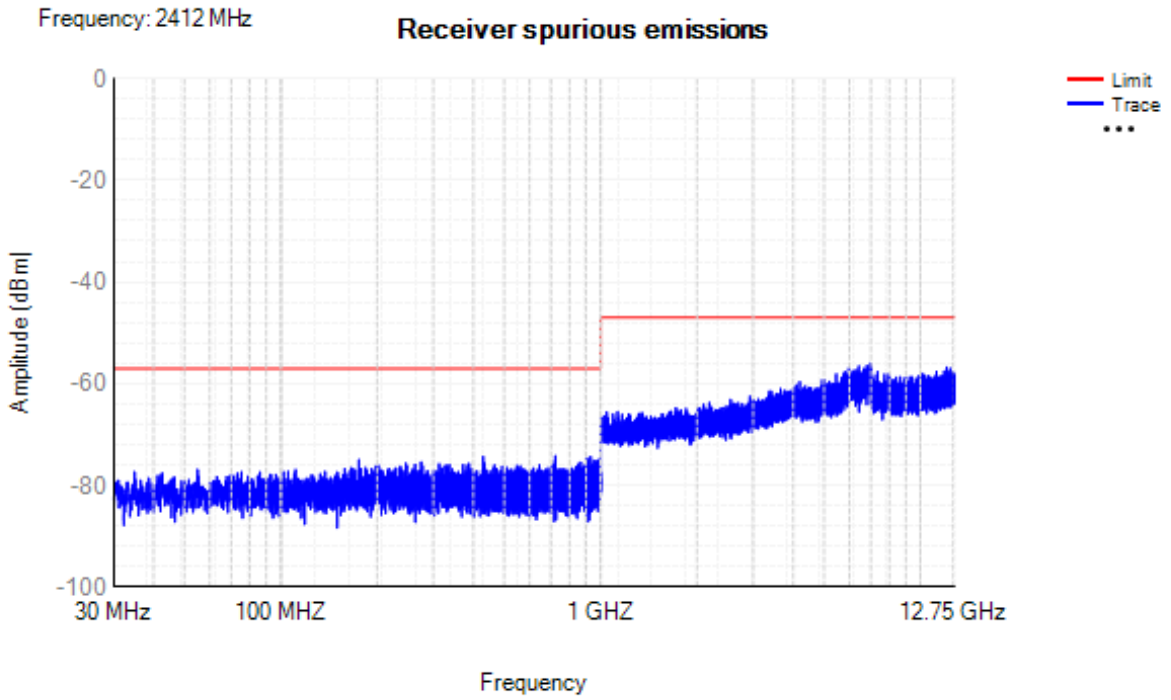

Rx. Spurious NVNT n20 2442MHz Ant1

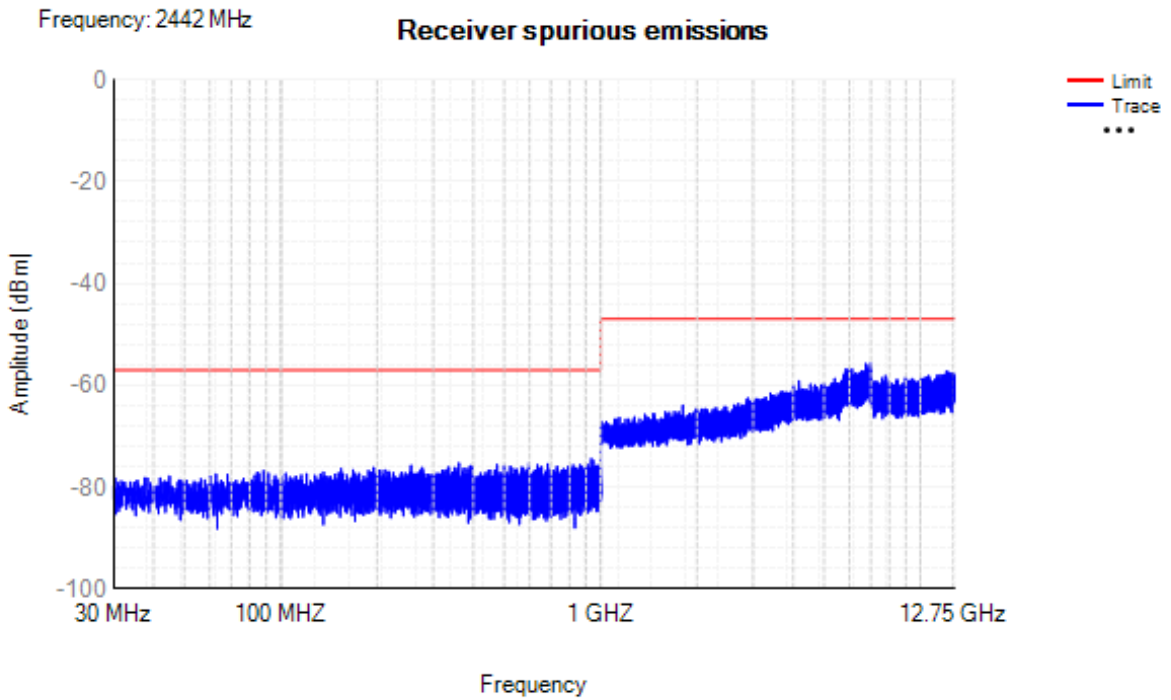

Rx. Spurious NVNT n20 2472MHz Ant1

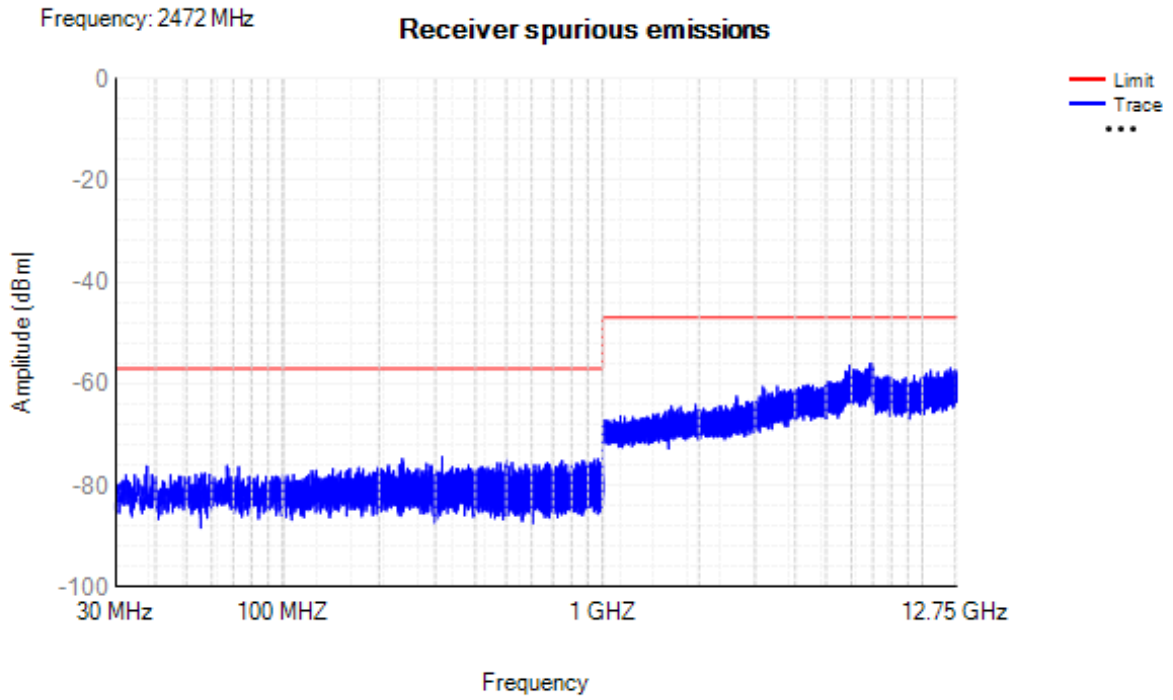

Rx. Spurious NVNT n40 2422MHz Ant1

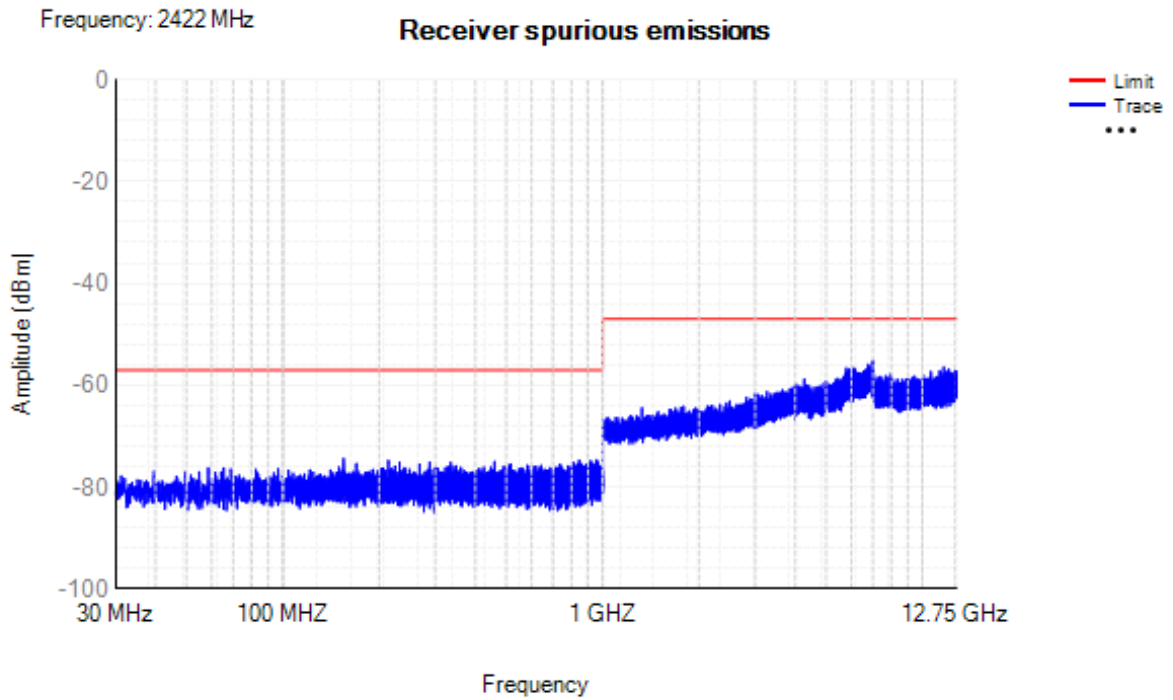

Rx. Spurious NVNT n40 2442MHz Ant1

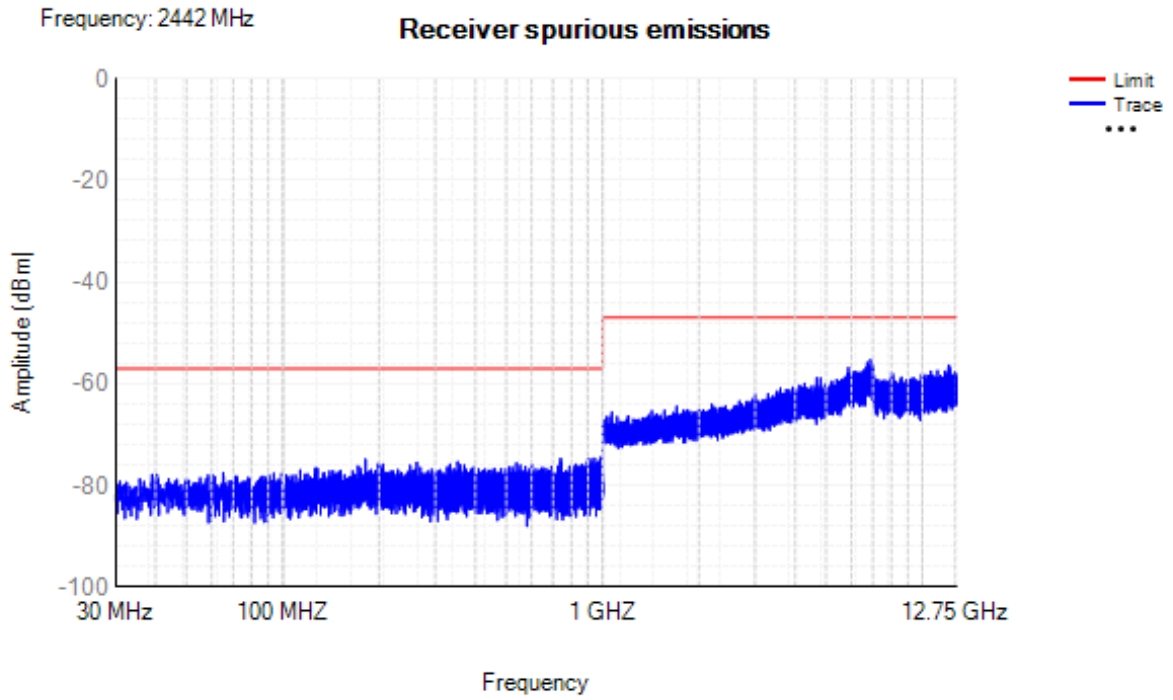

Rx. Spurious NVNT n40 2462MHz Ant1

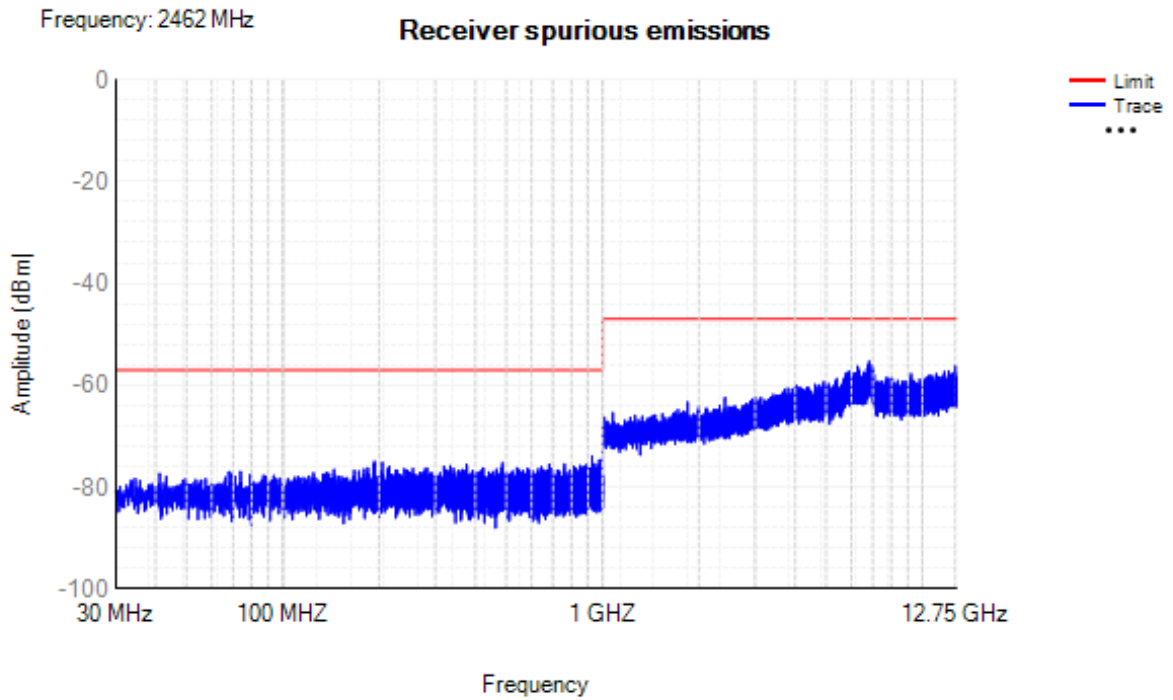

4.7 Adaptivity

| Condition | Mode          | Frequency (MHz) | AWGN Level (dBm/MHz) | CW Level (dBm) | Short Control Width (ms) | Short Control Ratio(%) | Limit (%) | Verdict |
|-----------|---------------|-----------------|----------------------|----------------|--------------------------|------------------------|-----------|---------|
| NVNT      | 802.11b       | 2412            | -65.91               | -35            | 0                        | 0                      | <=10      | Pass    |
| NVNT      | 802.11b       | 2472            | -65.65               | -35            | 0                        | 0                      | <=10      | Pass    |
| NVNT      | 802.11g       | 2412            | -63.07               | -35            | 0.87                     | 1.74                   | <=10      | Pass    |
| NVNT      | 802.11g       | 2472            | -63.06               | -35            | 3.47                     | 6.94                   | <=10      | Pass    |
| NVNT      | 802.11n(HT20) | 2412            | -61.12               | -35            | 0                        | 0                      | <=10      | Pass    |
| NVNT      | 802.11n(HT20) | 2472            | -61.19               | -35            | 0                        | 0                      | <=10      | Pass    |
| NVNT      | 802.11n(HT40) | 2422            | -60.46               | -35            | 0                        | 0                      | <=10      | Pass    |
| NVNT      | 802.11n(HT40) | 2462            | -60.6                | -35            | 0                        | 0                      | <=10      | Pass    |

Adaptivity NVNT 802.11b 2412MHz

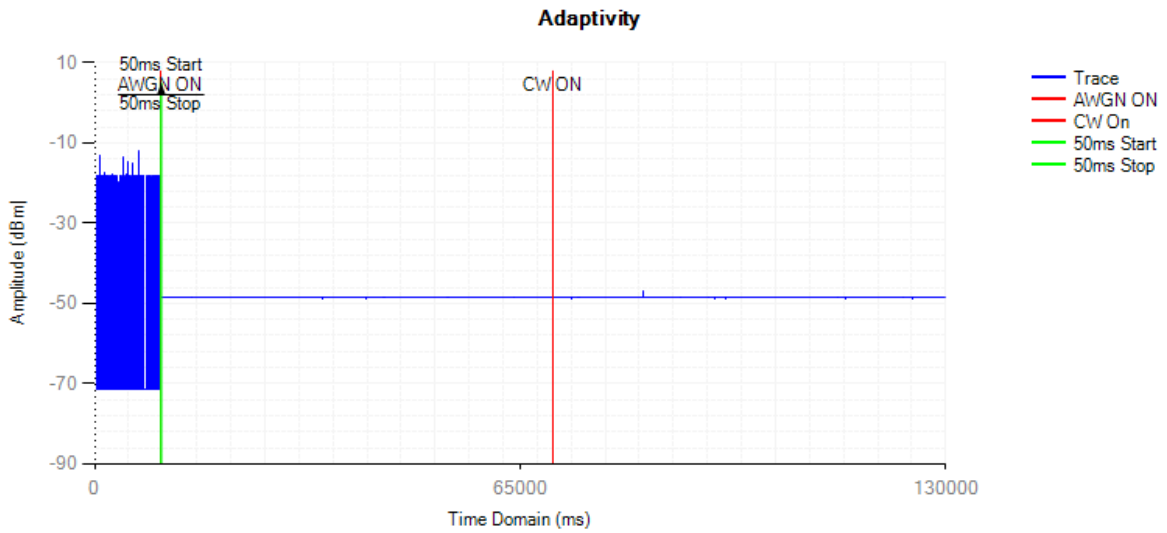

Control Signal NVNT 802.11b 2412MHz

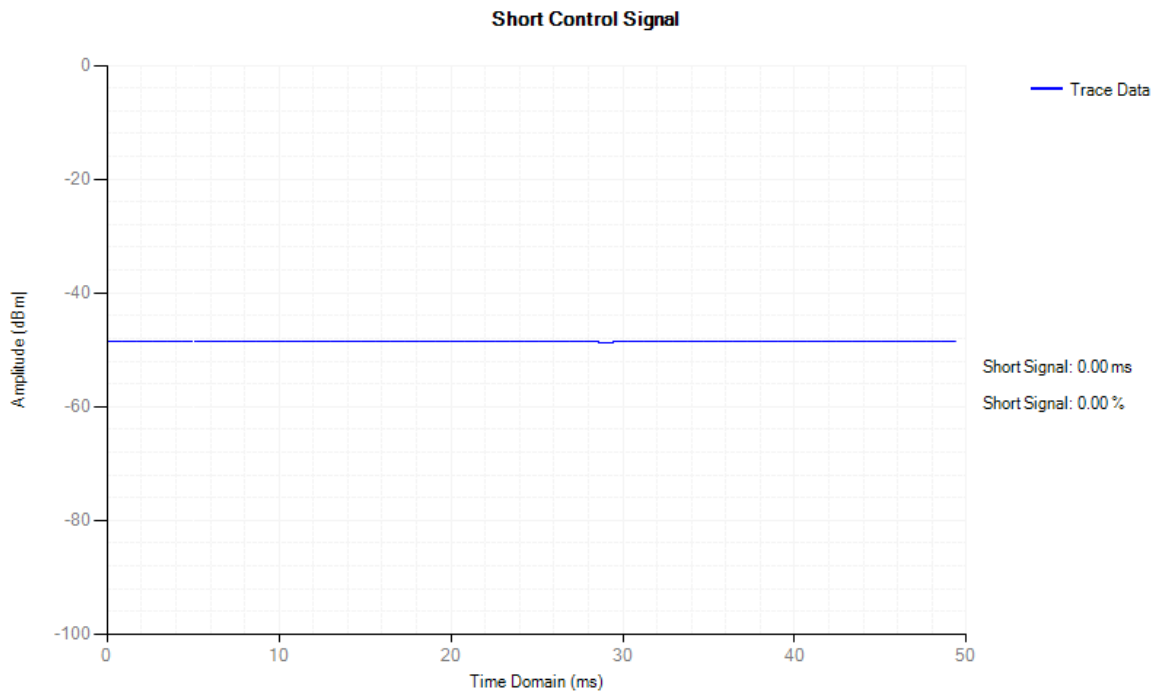

### Adaptivity NVNT 802.11b 2472MHz

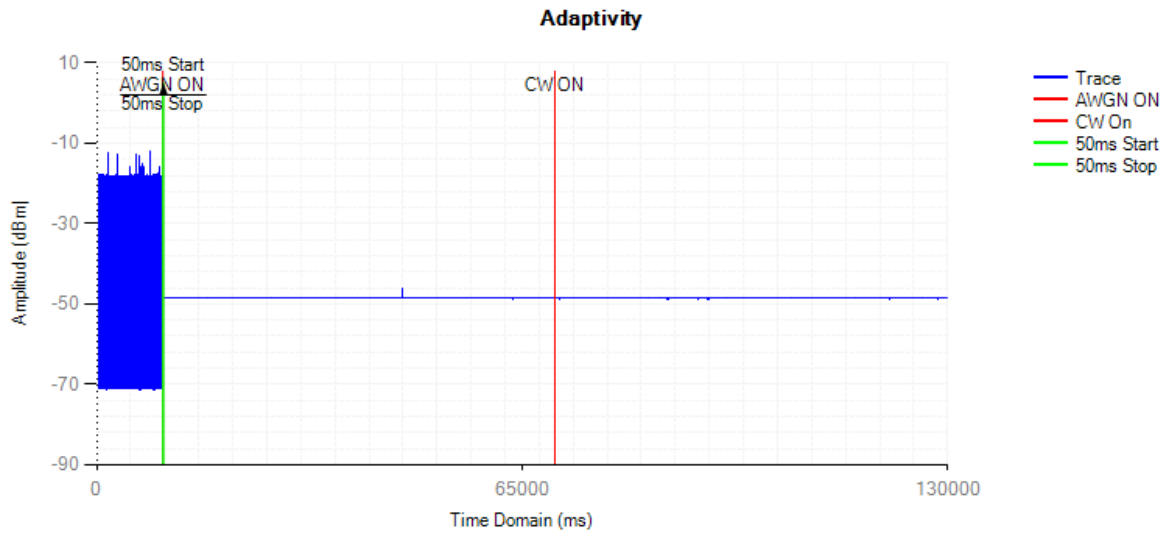

### Control Signal NVNT 802.11b 2472MHz

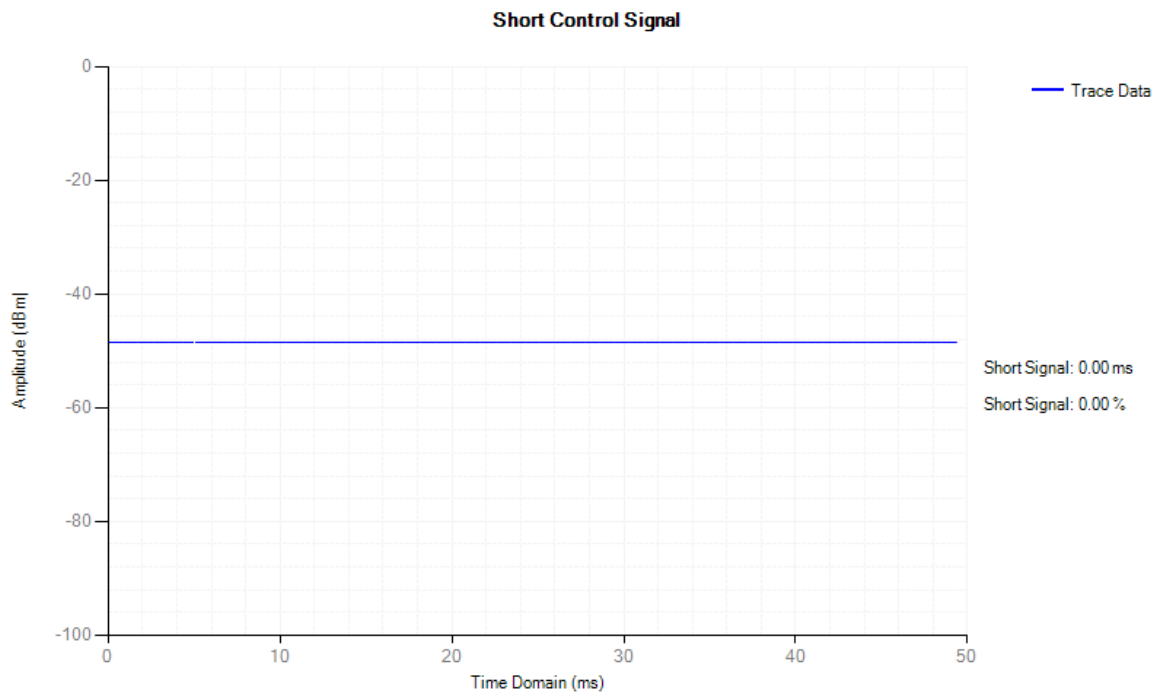



### Adaptivity NVNT 802.11g 2412MHz

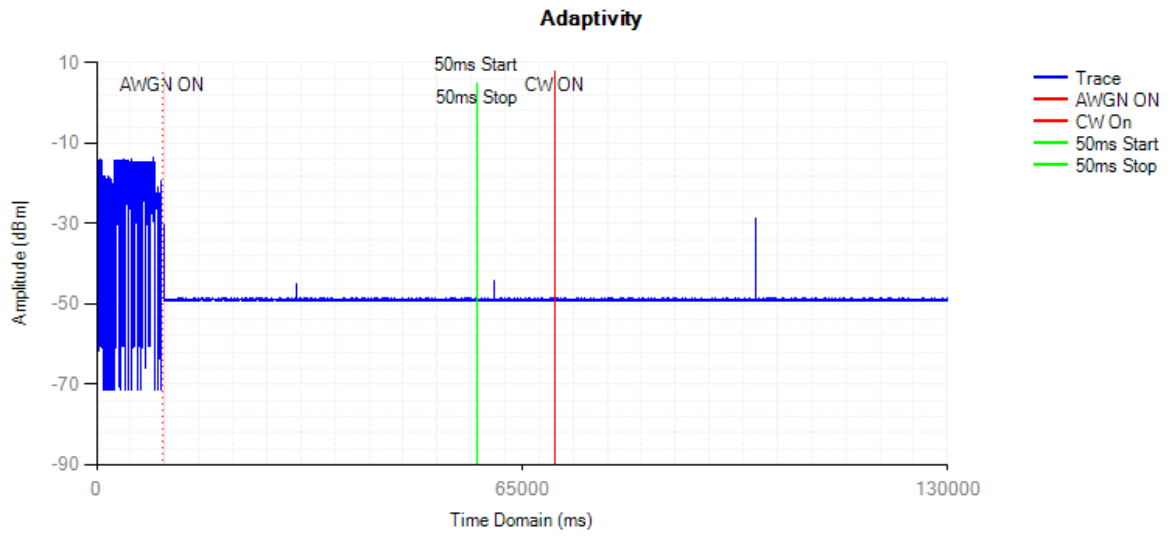

### Control Signal NVNT 802.11g 2412MHz

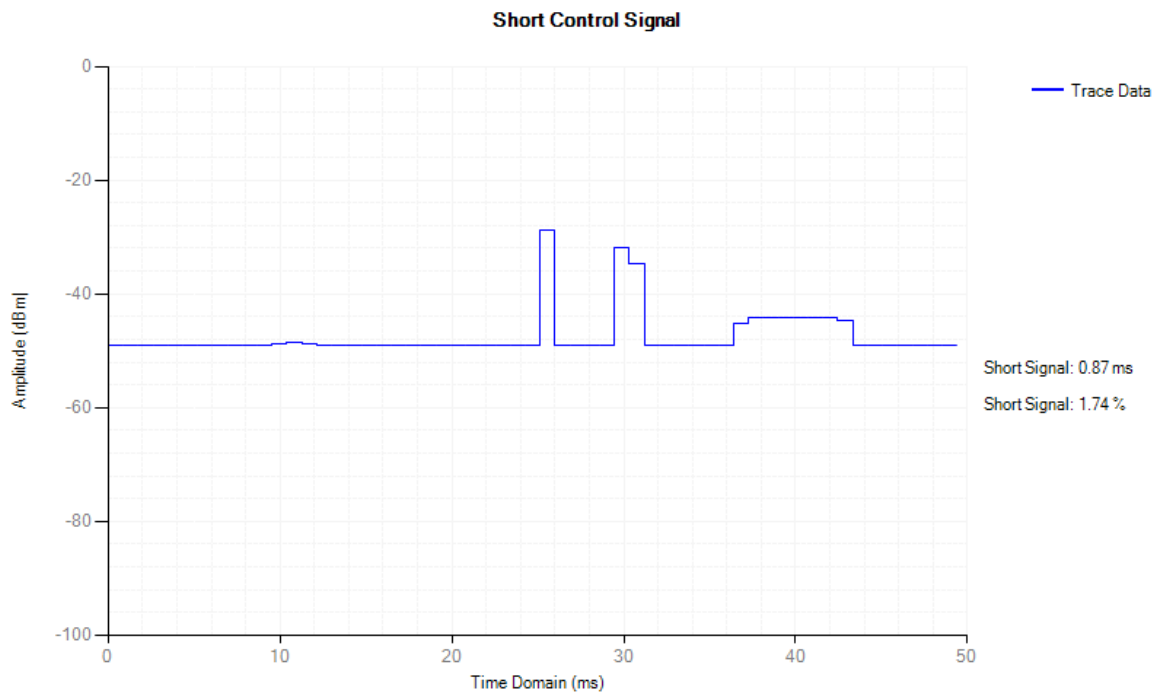

### Adaptivity NVNT 802.11g 2472MHz

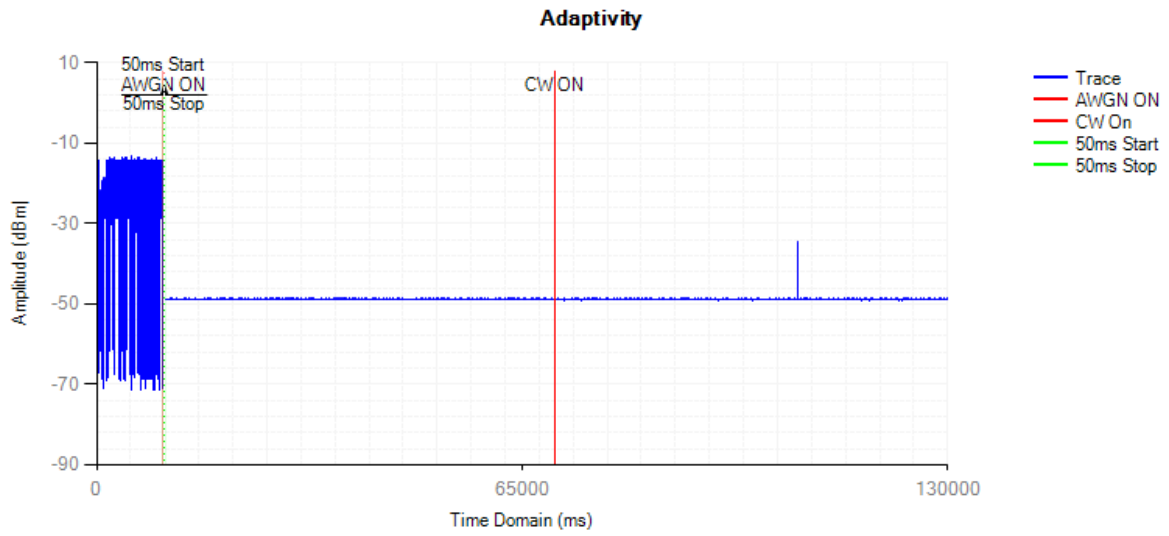

### Control Signal NVNT 802.11g 2472MHz

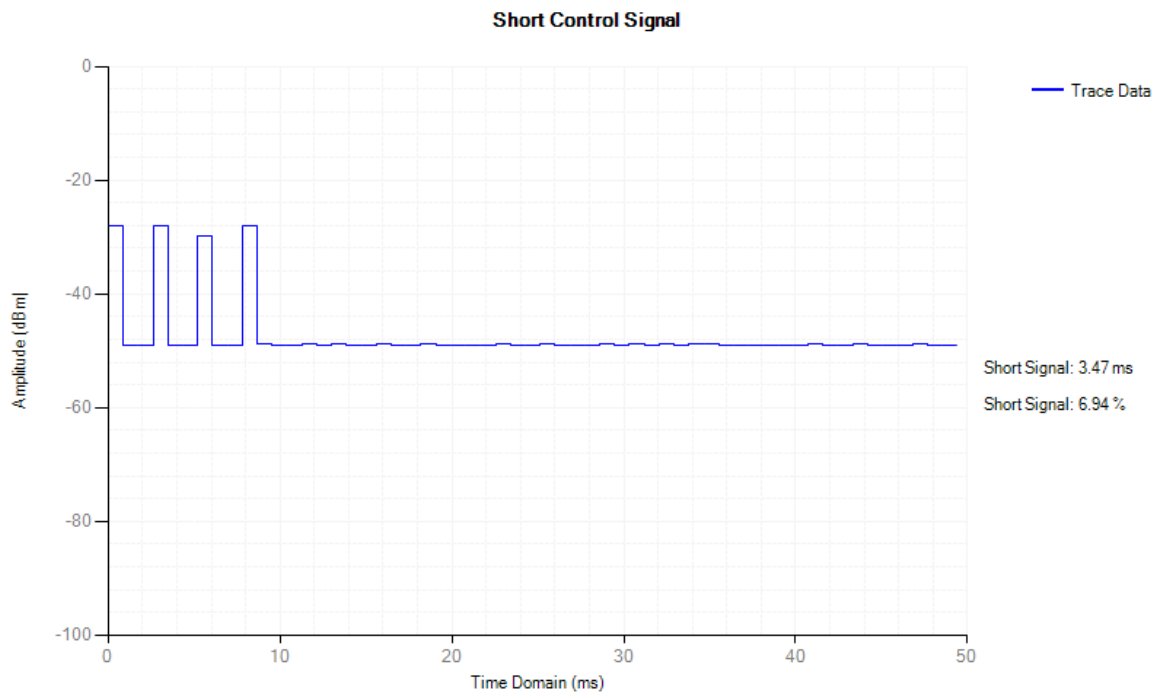

### Adaptivity NVNT 802.11n(HT20) 2412MHz

#### Adaptivity

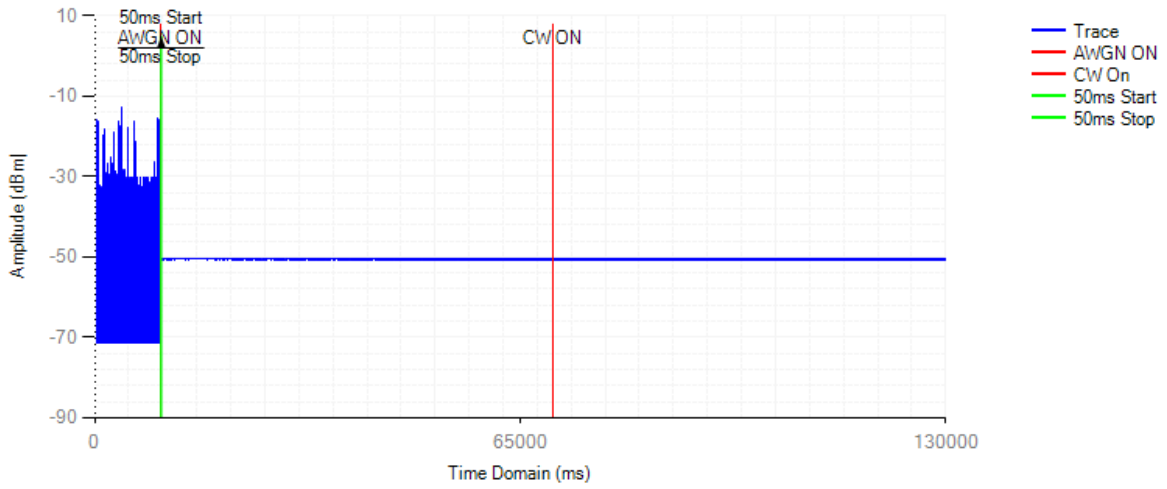

### Control Signal NVNT 802.11n(HT20) 2412MHz

#### Short Control Signal

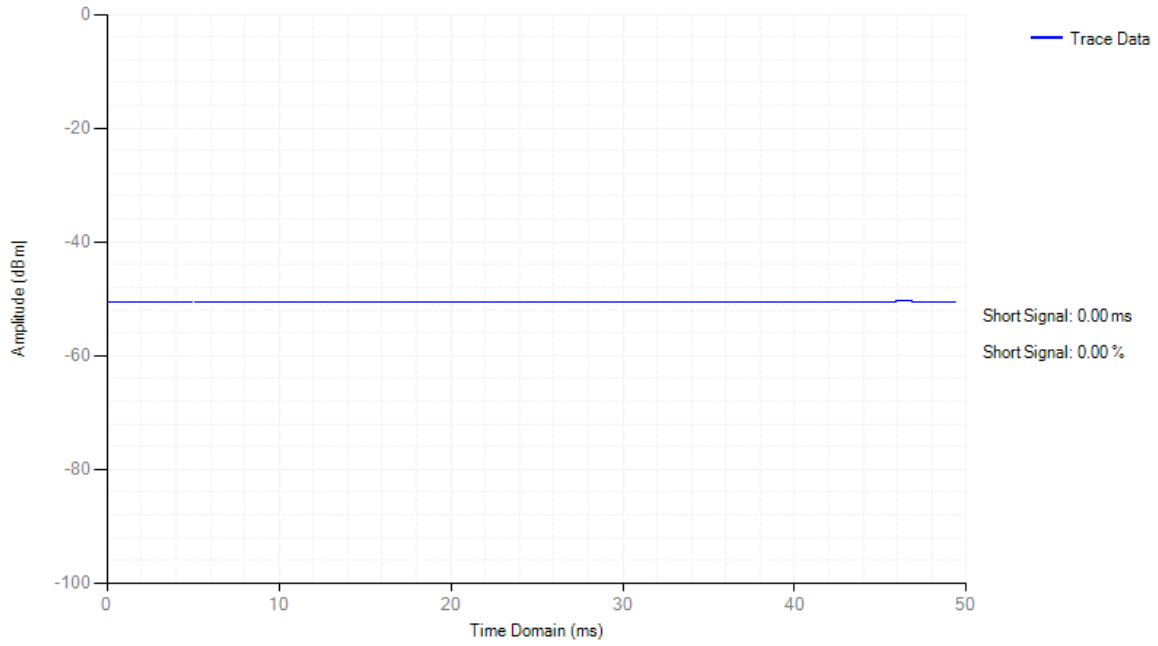

### Adaptivity NVNT 802.11n(HT20) 2472MHz

#### Adaptivity

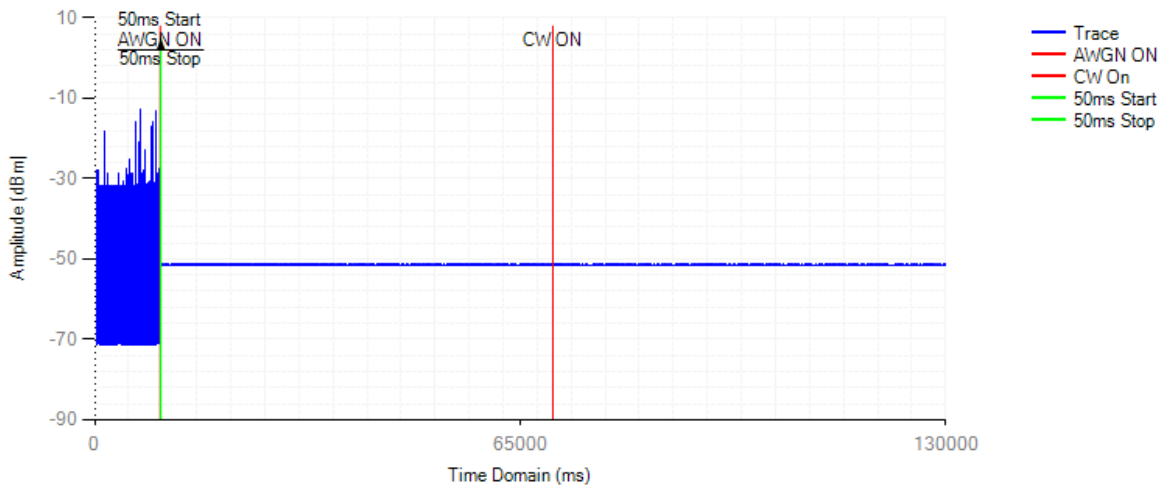

### Control Signal NVNT 802.11n(HT20) 2472MHz

#### Short Control Signal

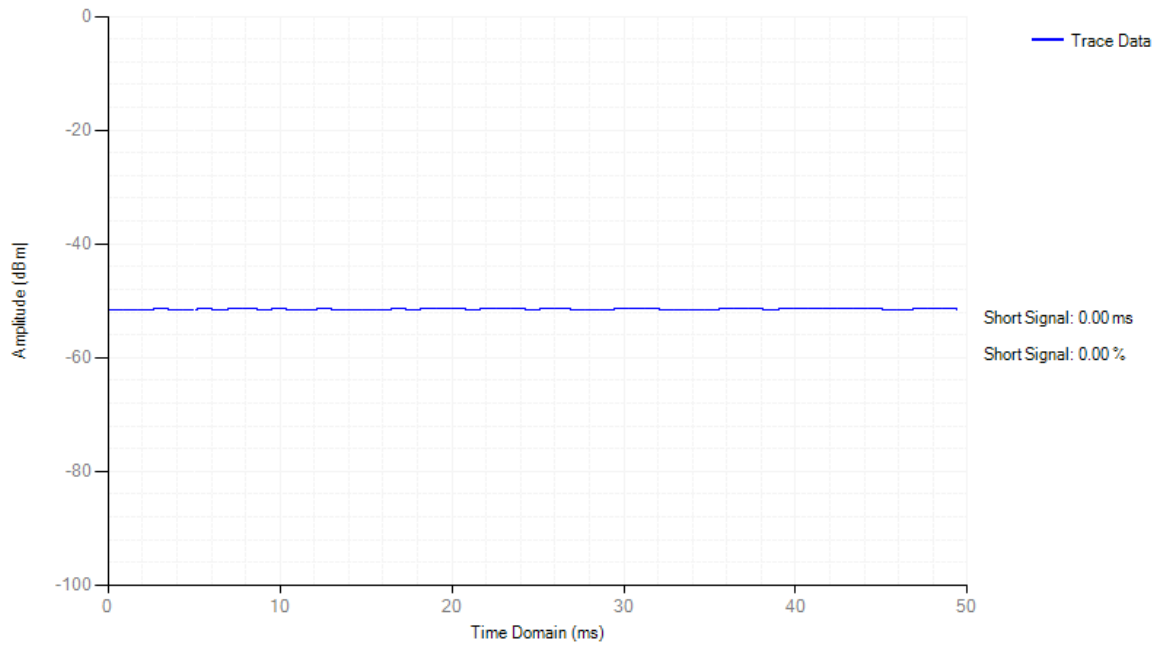

### Adaptivity NVNT 802.11n(HT40) 2422MHz

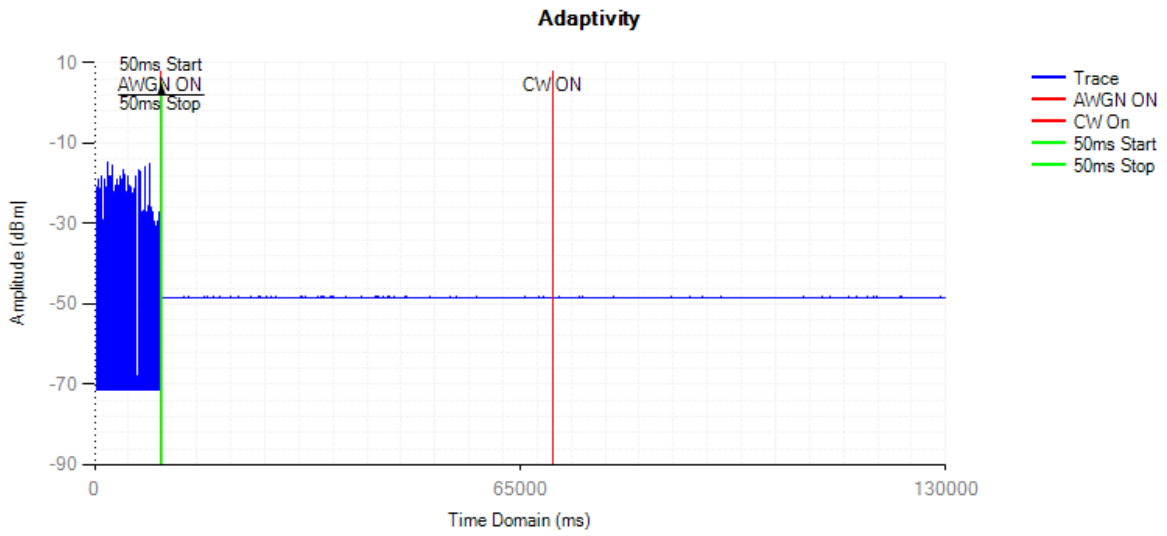

### Control Signal NVNT 802.11n(HT40) 2422MHz

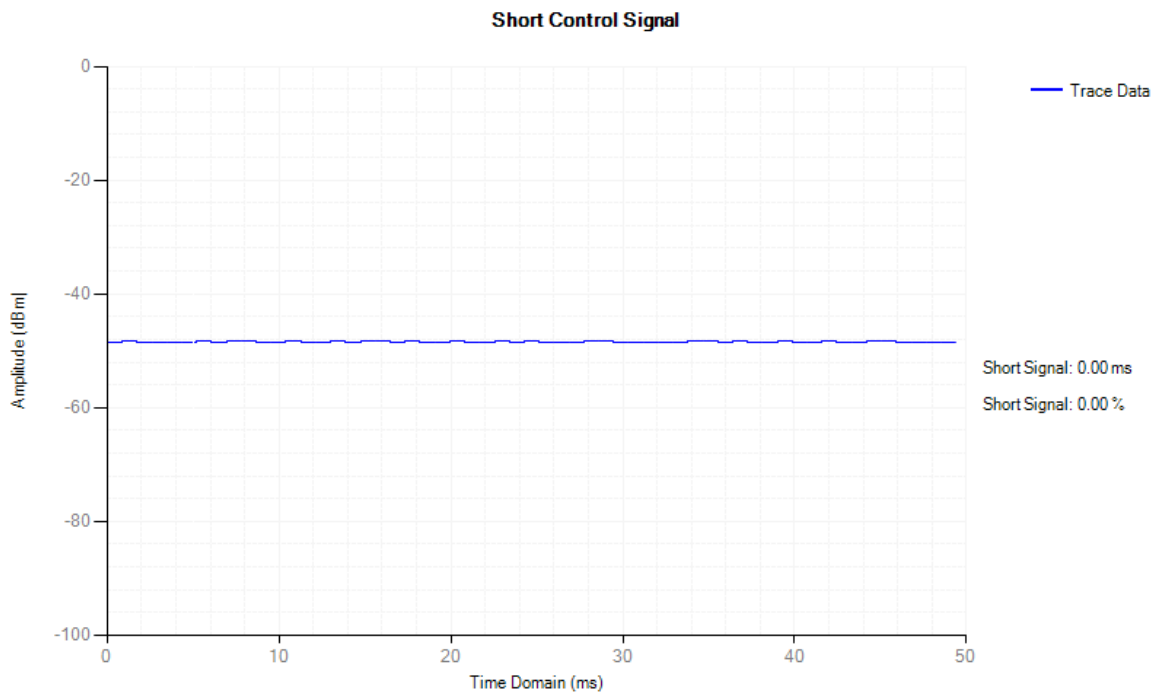

### Adaptivity NVNT 802.11n(HT40) 2462MHz

#### Adaptivity

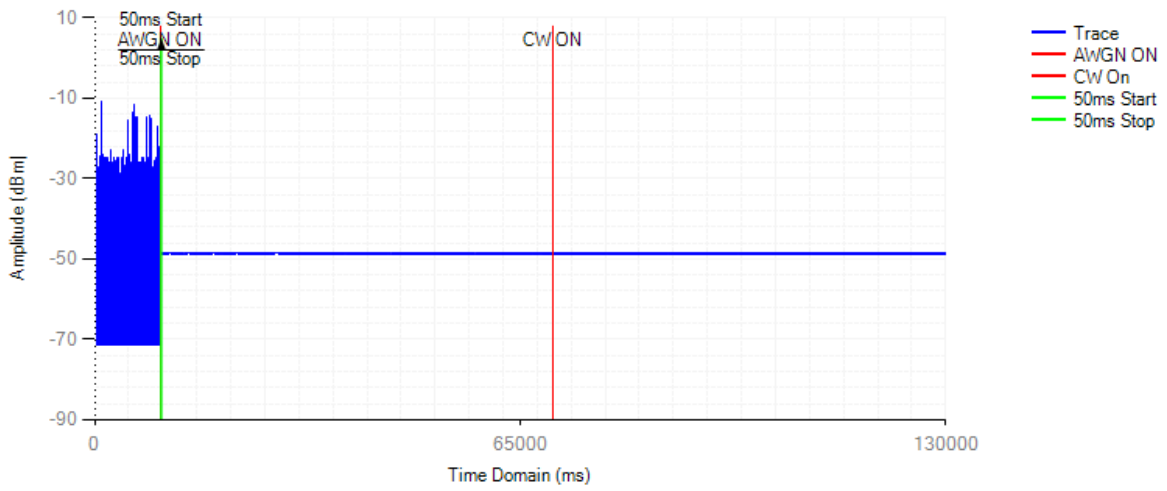

### Control Signal NVNT 802.11n(HT40) 2462MHz

#### Short Control Signal

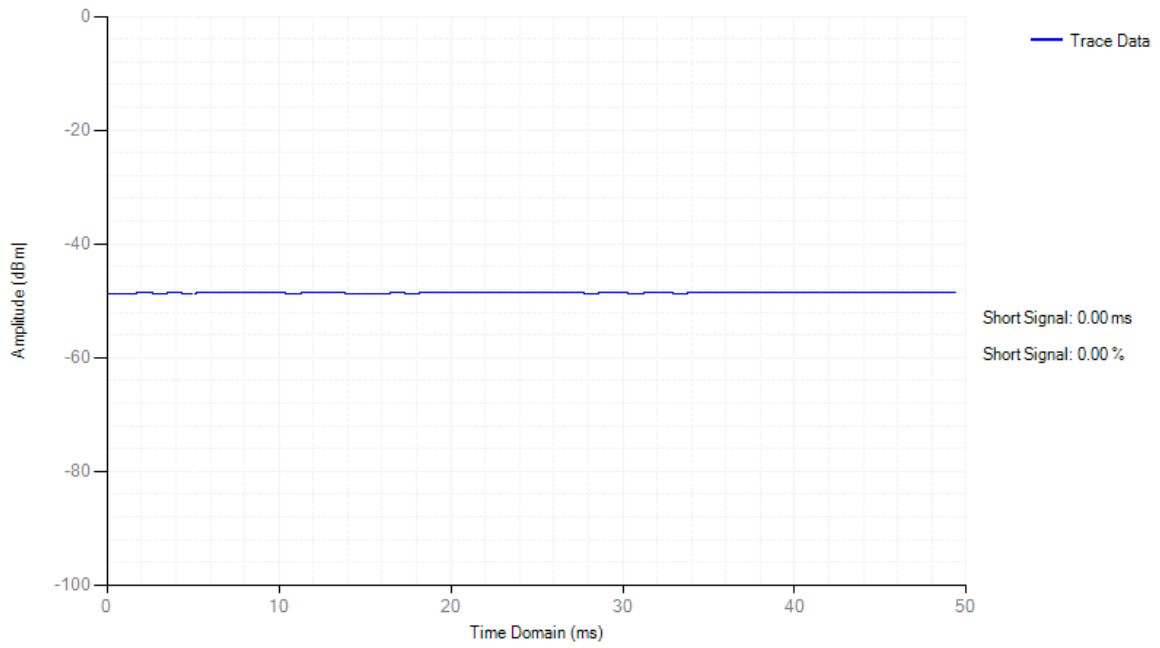



4.8 Adaptivity COT Channel Occupancy Time

| Condition | Mode          | Frequency (MHz) | Priority Class | Max COT (ms) | Limit COT (ms) | Min Idle Time (ms) | Limit Idle Time (ms) | Verdict |
|-----------|---------------|-----------------|----------------|--------------|----------------|--------------------|----------------------|---------|
| NVNT      | 802.11b       | 2412            | 1              | 0.702        | <=13           | 0.118              | >0.018               | Pass    |
| NVNT      | 802.11b       | 2472            | 1              | 0.265        | <=13           | 0.037              | >0.018               | Pass    |
| NVNT      | 802.11g       | 2412            | 1              | 0.278        | <=13           | 0.06               | >0.018               | Pass    |
| NVNT      | 802.11g       | 2472            | 1              | 0.465        | <=13           | 0.045              | >0.018               | Pass    |
| NVNT      | 802.11n(HT20) | 2412            | 1              | 0.982        | <=13           | 0.105              | >0.018               | Pass    |
| NVNT      | 802.11n(HT20) | 2472            | 1              | 1.117        | <=13           | 0.257              | >0.018               | Pass    |
| NVNT      | 802.11n(HT40) | 2422            | 1              | 0.273        | <=13           | 0.047              | >0.018               | Pass    |
| NVNT      | 802.11n(HT40) | 2462            | 1              | 1.003        | <=13           | 0.098              | >0.018               | Pass    |

COT NVNT 802.11b 2412MHz

Channel Occupation Time

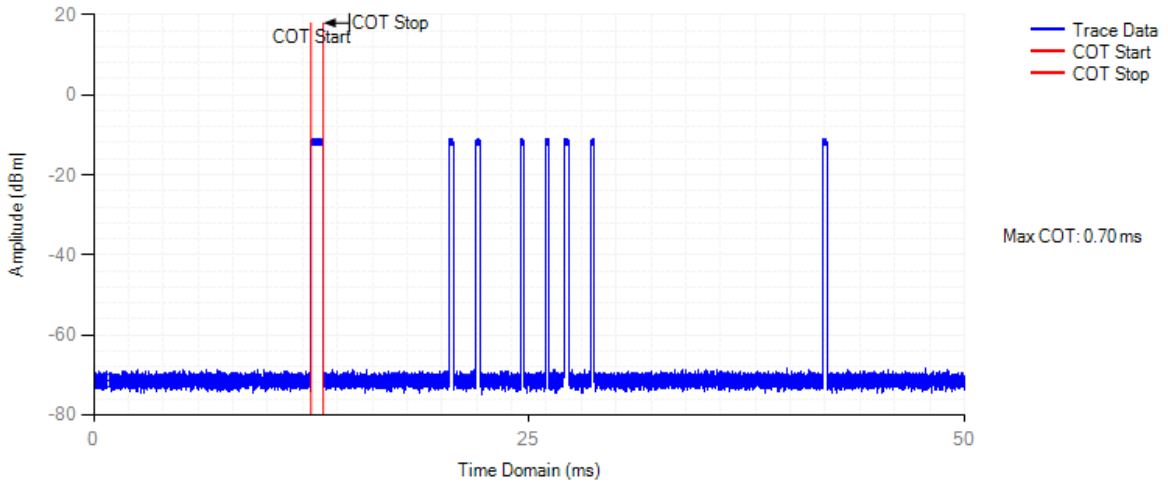

Idle NVNT 802.11b 2412MHz

Channel Occupation Time

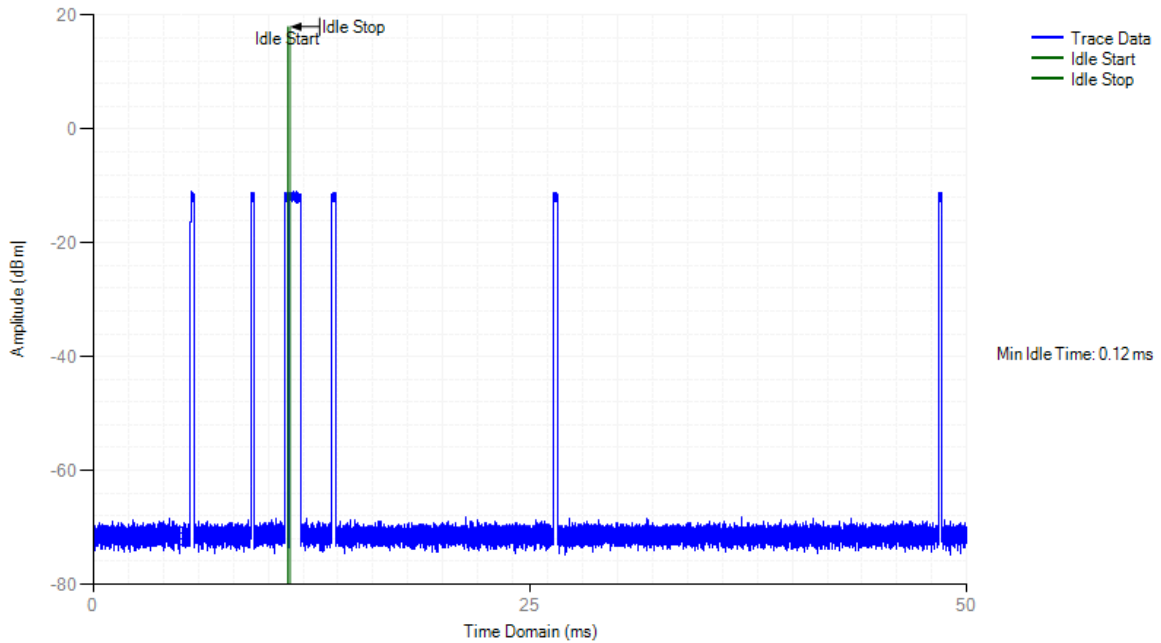

### COT NVNT 802.11b 2472MHz

#### Channel Occupation Time

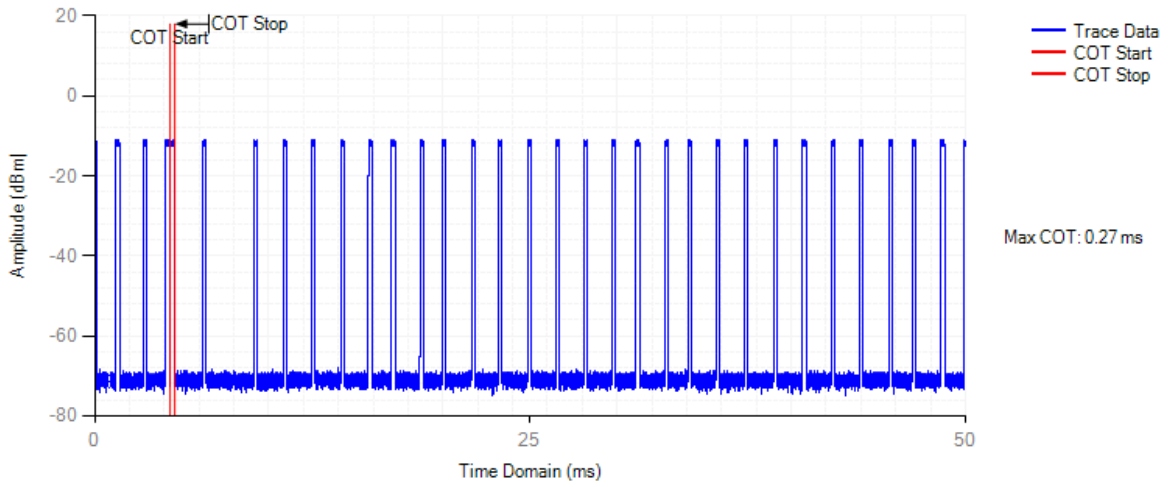

### Idle NVNT 802.11b 2472MHz

#### Channel Occupation Time

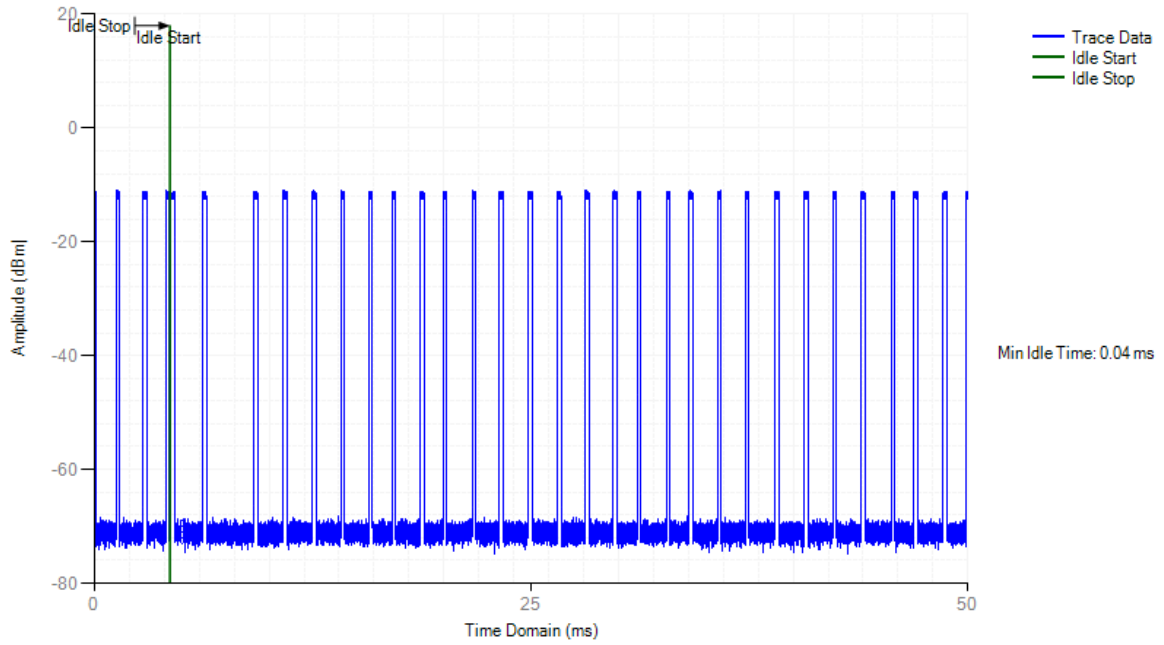

### COT NVNT 802.11g 2412MHz

#### Channel Occupation Time

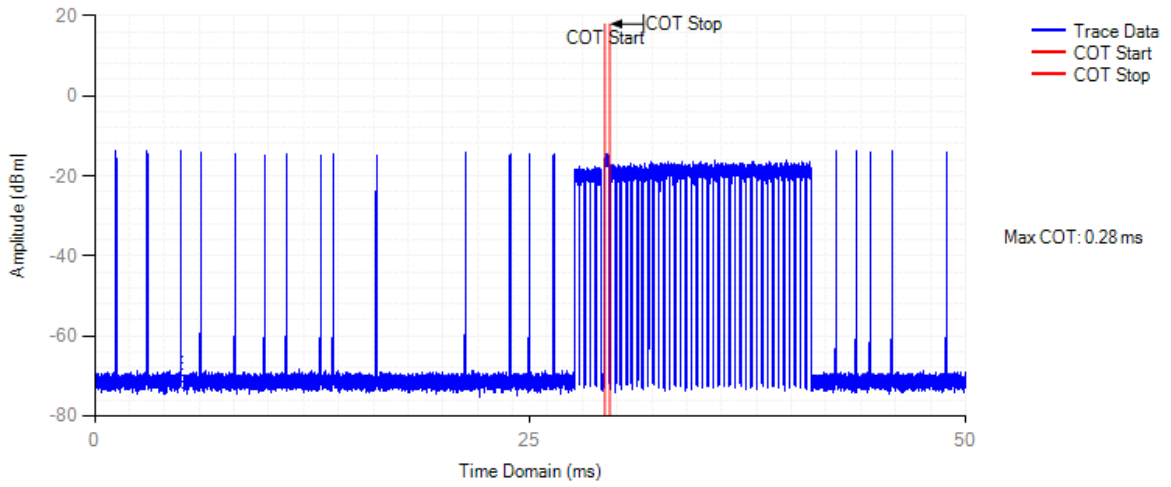

### Idle NVNT 802.11g 2412MHz

#### Channel Occupation Time

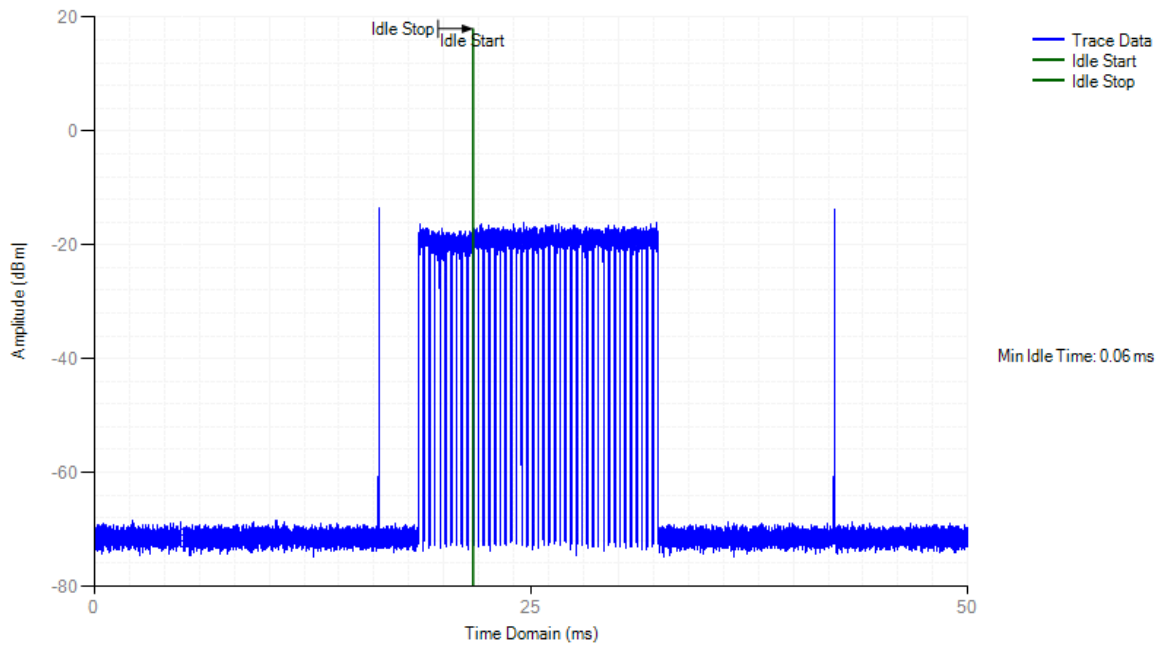

### COT NVNT 802.11g 2472MHz

#### Channel Occupation Time



### Idle NVNT 802.11g 2472MHz

#### Channel Occupation Time

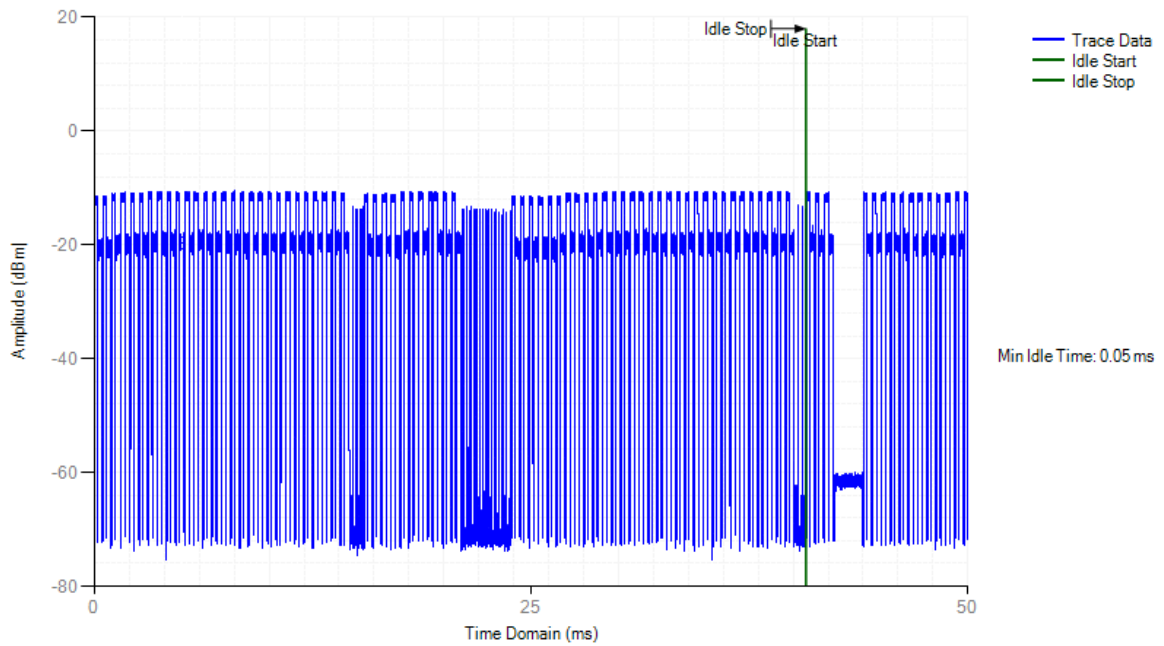

### COT NVNT 802.11n(HT20) 2412MHz

#### Channel Occupation Time

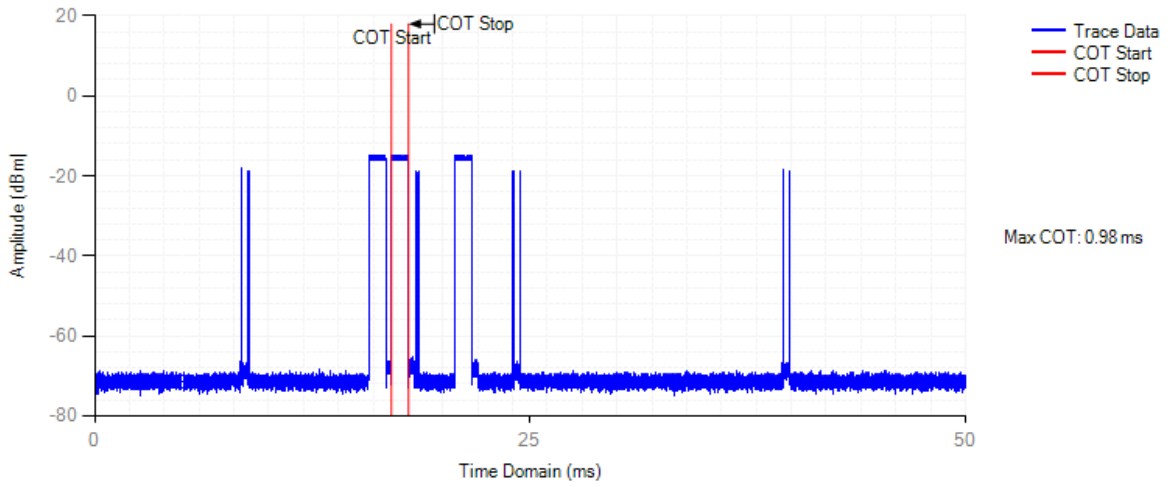

### Idle NVNT 802.11n(HT20) 2412MHz

#### Channel Occupation Time

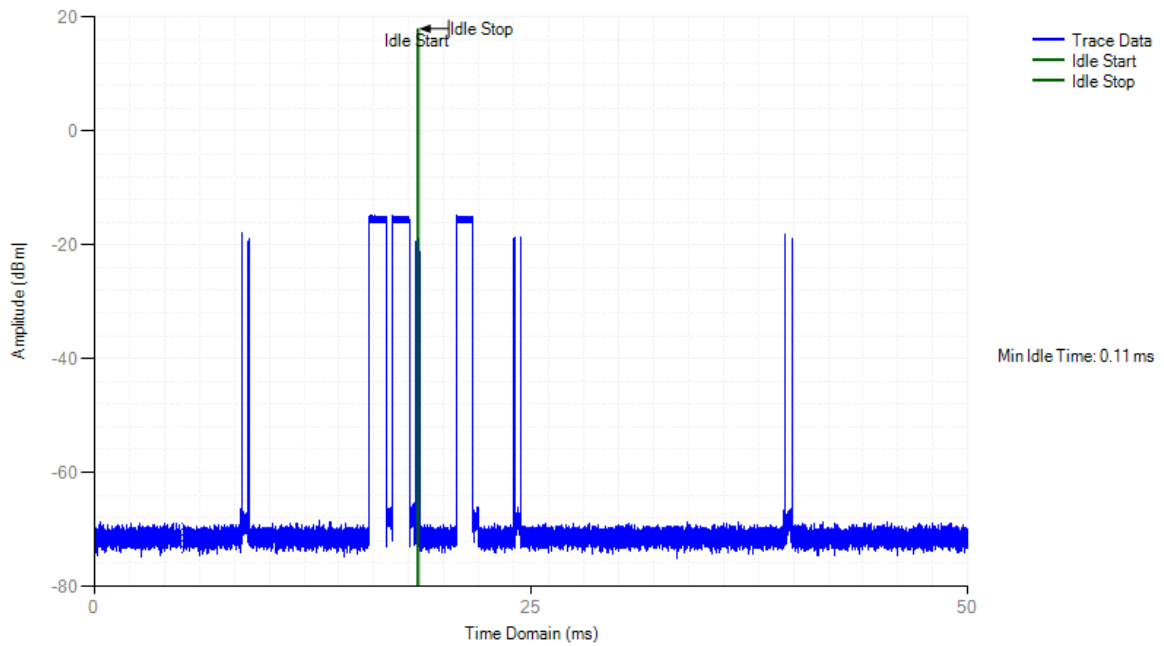

### COT NVNT 802.11n(HT20) 2472MHz

#### Channel Occupation Time

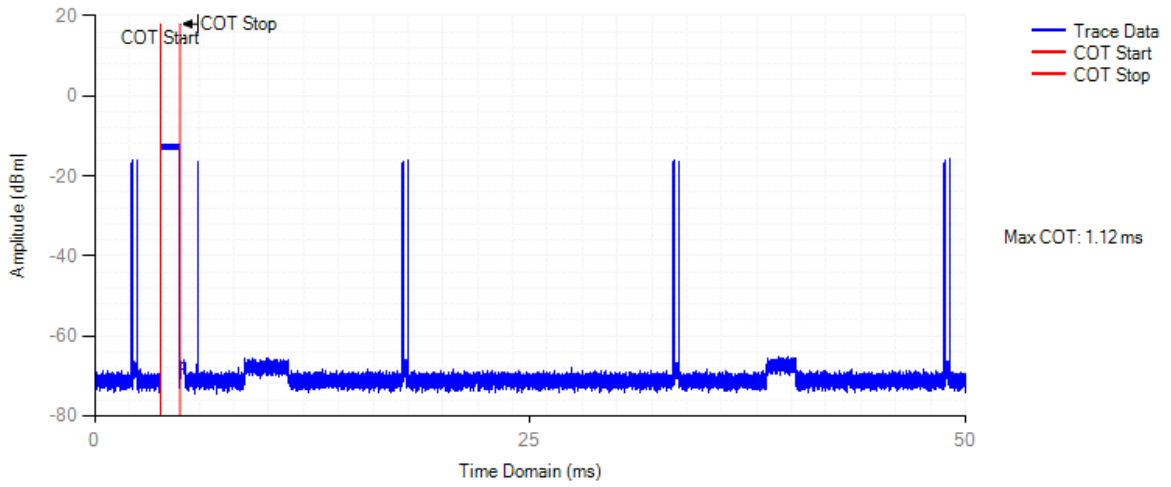

### Idle NVNT 802.11n(HT20) 2472MHz

#### Channel Occupation Time

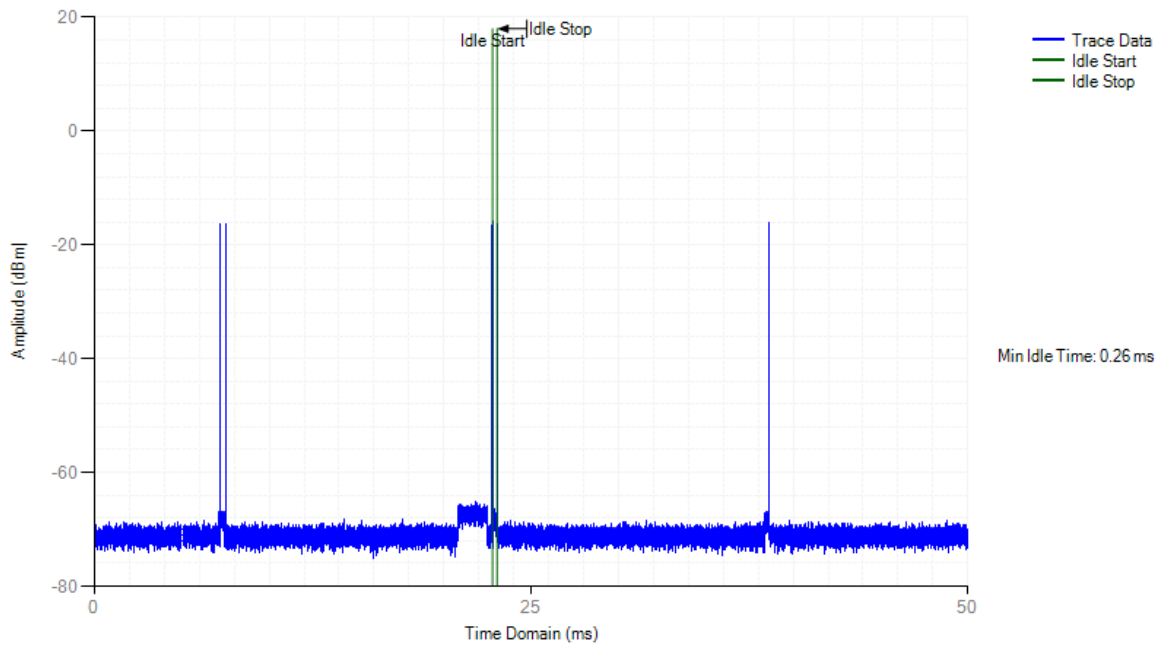



### COT NVNT 802.11n(HT40) 2422MHz

#### Channel Occupation Time

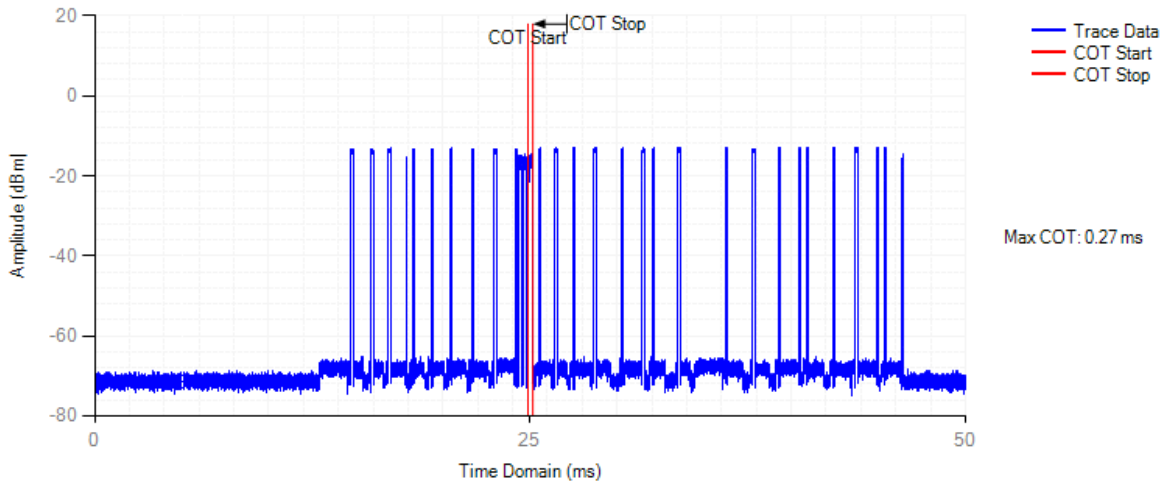

### Idle NVNT 802.11n(HT40) 2422MHz

#### Channel Occupation Time

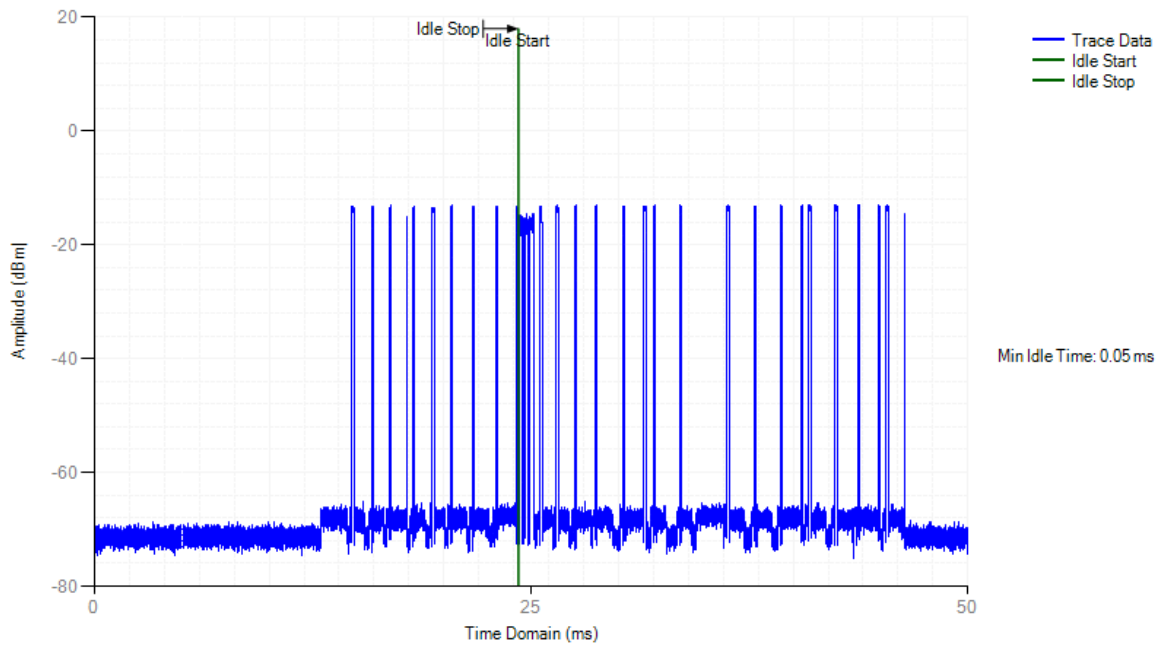

### COT NVNT 802.11n(HT40) 2462MHz

#### Channel Occupation Time

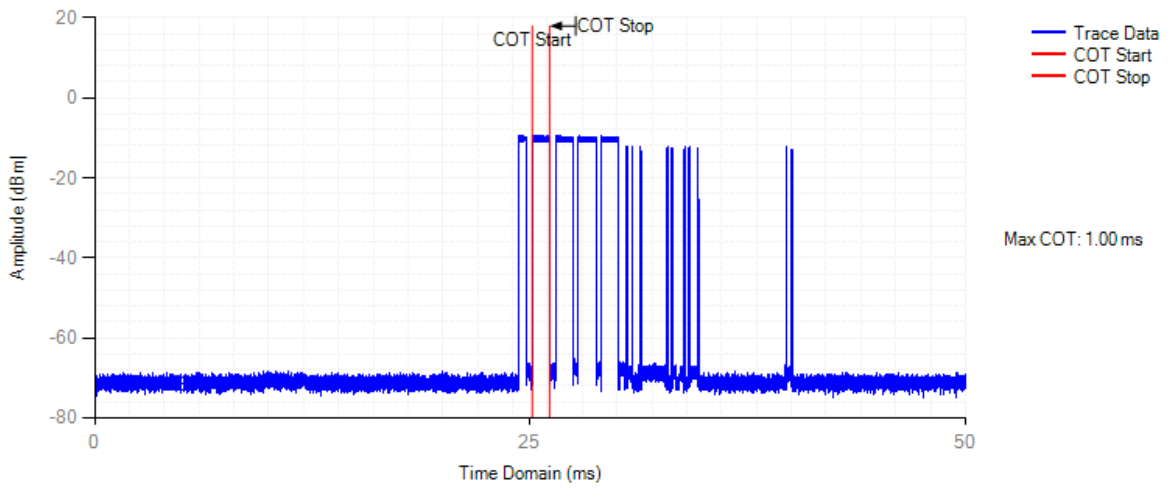

### Idle NVNT 802.11n(HT40) 2462MHz

#### Channel Occupation Time

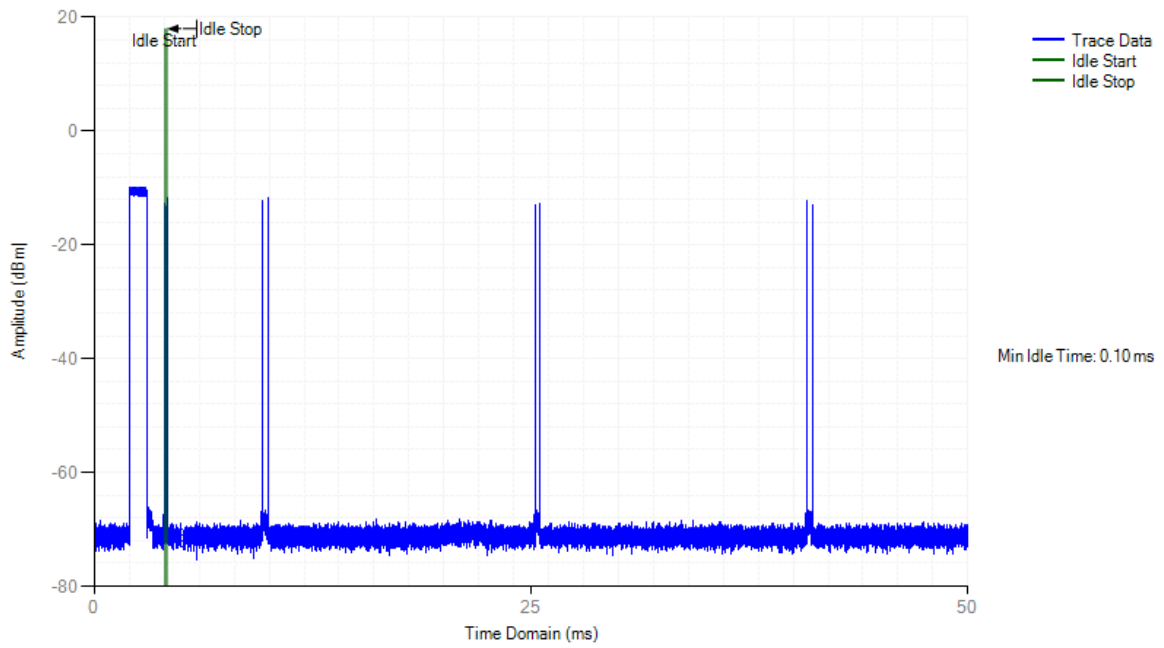

5. EUT TEST PHOTO

SPURIOUS EMISSIONS MEASUREMENT PHOTOS

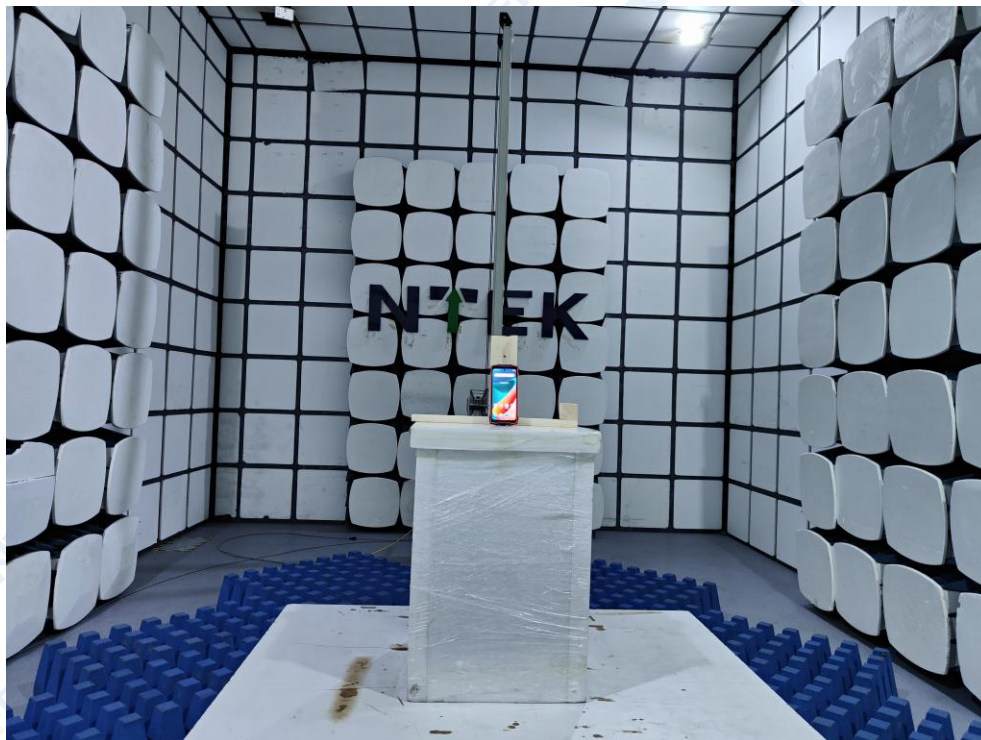
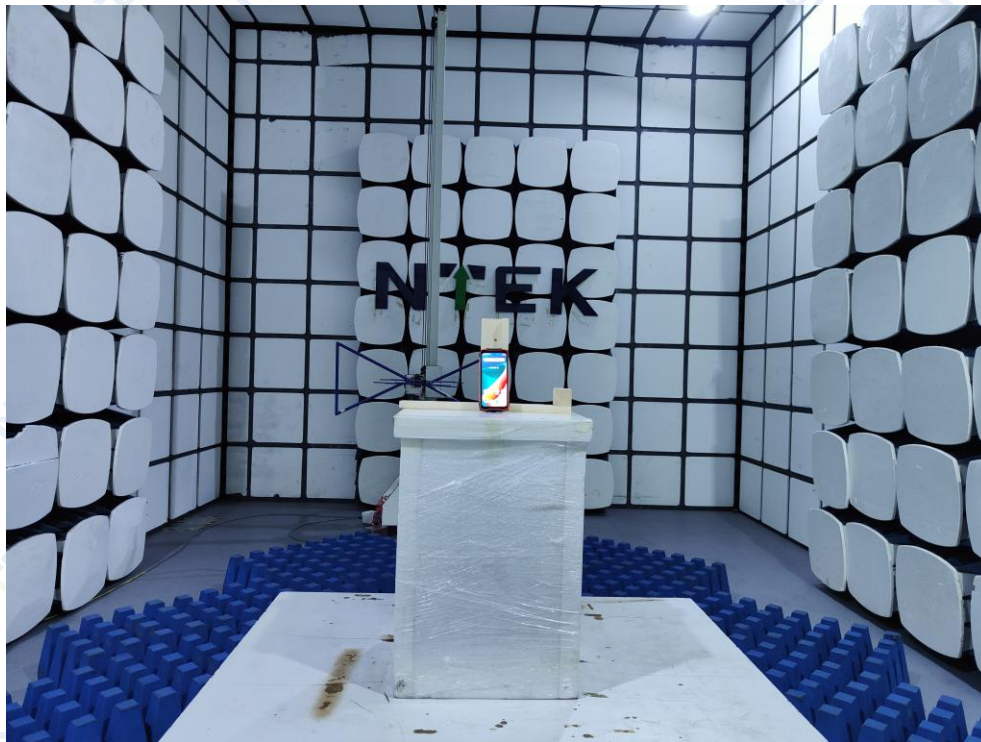

END OF REPORT