



RADIO TEST REPORT

ETSI EN 303 413 V1.2.1 (2021-04)

Product : smartphone

Trade Mark : Blackview

Model Name : N6000

Family Model : N/A

Report No. : S23051103003010

Prepared for

DOKE COMMUNICATION (HK) LIMITED

RM 1902 EASEY COMM BLDG 253-261 HENNESSY ROAD WANCHAI HK CHINA

Prepared by

Shenzhen NTEK Testing Technology Co., Ltd.

1/F, Building E, Fenda Science Park, Sanwei Community, Xixiang Street

Bao'an District, Shenzhen 518126 P.R. China

Tel. 400-800-6106, 0755-2320 0050, 0755-2320 0090

Website:<http://www.ntek.org.cn>

TEST RESULT CERTIFICATION

Applicant's Name : DOKE COMMUNICATION (HK) LIMITED
Address..... : RM 1902 EASEY COMM BLDG 253-261 HENNESSY ROAD
 WANCHAI HK CHINA
Manufacturer's Name : Shenzhen DOKE Electronic Co., Ltd
Address..... : 801, Building3, 7th Industrial Zone, Yulv Community, Yutang Road,
 Guangming District, Shenzhen, China.

Product description

Product name..... : smartphone
 Trademark : Blackview
 Model Name : N6000
 Family Model..... : N/A

Standards : ETSI EN 303 413 V1.2.1 (2021-04)

This device described above has been tested by Shenzhen NTEK, and the test results show that the equipment under test (EUT) is in compliance with the article 3.2 of Directive 2014/53/EU requirements. And it is applicable only to the tested sample identified in the report.

This report shall not be reproduced except in full, without the written approval of Shenzhen NTEK, this document may be altered or revised by Shenzhen NTEK, personnel only, and shall be noted in the revision of the document.

Test Sample Number : S230511030005
Date of Test
 Date (s) of performance of tests..... : May 11, 2023 ~ Jun 05, 2023
 Date of Issue : Jun 05, 2023
 Test Result..... : **Pass**

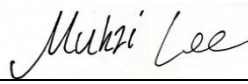
Testing Engineer : 

 (Mukzi Lee)

Authorized Signatory : 

 (Alex Li)

Table of Contents	Page
1 . SUMMARY OF TEST RESULTS	4
1.1 TEST FACILITY	5
1.2 MEASUREMENT UNCERTAINTY	5
2 . GENERAL INFORMATION	6
2.1 GENERAL DESCRIPTION OF EUT	6
2.2 DESCRIPTION OF TEST CONDITIONS	7
2.3 BLOCK DIGRAM SHOWING THE CONFIGURATION OF SYSTEM TESTED	8
2.4 DESCRIPTION OF SUPPORT UNITS	9
2.5 EQUIPMENTS LIST FOR ALL TEST ITEMS	10
3 . RECEIVER BLOCKING	11
3.1 APPLIED PROCEDURES / LIMIT	11
3.2 TEST FREQUENCY & SIGNAL	11
3.3 TEST PROCEDURE	12
3.4 TEST SETUP	12
3.5 TEST RESULTS	13
4 . SPURIOUS EMISSIONS	14
4.1 APPLIED PROCEDURES / LIMIT	14
4.2 TEST PROCEDURES	14
4.3 TEST SETUP	15
4.4 EUT OPERATION DURING TEST	15
4.5 TEST RESULTS (30MHZ ~ 1000MHZ)	16
4.6 TEST RESULTS (1GHZ ~ 8.3GHZ)	17
5 . EUT TEST PHOTO	18
SPURIOUS EMISSIONS MEASUREMENT PHOTOS	18
APPENDIX-PHOTOGRAPHS OF EUT CONSTRUCTIONAL DETAILS	

1. SUMMARY OF TEST RESULTS

Test procedures according to the technical standards:
ETSI EN 303 413 V1.2.1 (2021-04)

Clause	Description of Test Item	Remarks	Results
Receiver Parameters			
4.2.1	RECEIVER BLOCKING	Conducted	Pass
4.2.2	Spurious emissions	Radiated	Pass

1.1 TEST FACILITY

Shenzhen NTEK Testing Technology Co., Ltd.

Add. : 1/F, Building E, Fenda Science Park, Sanwei Community, Xixiang Street, Bao'an District, Shenzhen 518126 P.R. China

FCC Registered No.: 463705 IC Registered No.:9270A-1

CNAS Registration No.:L5516

1.2 MEASUREMENT UNCERTAINTY

The reported uncertainty of measurement $y \pm U$, where expanded uncertainty U is based on a standard uncertainty multiplied by a coverage factor of $k=2$, providing a level of confidence of approximately **95 %**.

No.	Item	Uncertainty
1	Conducted Emission Test	$\pm 1.38\text{dB}$
2	RF power,conducted	$\pm 0.16\text{dB}$
3	Spurious emissions,conducted	$\pm 0.21\text{dB}$
4	All emissions,radiated(<1G)	$\pm 4.68\text{dB}$
5	All emissions,radiated(>1G)	$\pm 4.89\text{dB}$
6	Temperature	$\pm 0.5^\circ\text{C}$
7	Humidity	$\pm 2\%$

2. GENERAL INFORMATION

2.1 GENERAL DESCRIPTION OF EUT

Equipment	smartphone	
Trade Mark	Blackview	
Model Name	N6000	
Family Model	N/A	
Model Difference	N/A	
Product Description	Operation Frequency:	1.57542GHz
	Modulation Type:	BPSK modulation
	Antenna Designation:	PIFA Antenna
	The product only receives.	
Channel List	Refer to below	
Adapter	Model: QZ-01800EA00 Input: 100-240V~50/60Hz 0.5A Output: 5.0V---3.0A or 7.0V---2.0A or 9.0V---2.0A or 12.0V---1.5A (18.0W)	
Battery	DC 3.87V, 3880mAh, 15.01Wh	
Rating	DC 3.87V from battery or DC 5V from adapter	
Hardware Version	TE305_MAIN_PCB_V1.1	
Software Version	N6000_EEA_TE305_V1.0_01	

Note:

1. For a more detailed features description, please refer to the manufacturer's specifications or the User's Manual.

;

2.2 DESCRIPTION OF TEST CONDITIONS

Pretest Mode	Description
Mode 1	RX(CH01)

For Conducted Test	
Final Test Mode	Description
Mode 1	RX(CH01)

For Radiated Test	
Final Test Mode	Description
Mode 1	RX(CH01)

2.3 BLOCK DIGRAM SHOWING THE CONFIGURATION OF SYSTEM TESTED

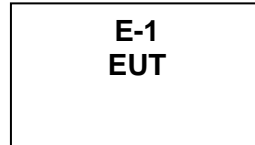

2.4 DESCRIPTION OF SUPPORT UNITS

The EUT has been tested as an independent unit together with other necessary accessories or support units. The following support units or accessories were used to form a representative test configuration during the tests.

Item	Equipment	Model/Type No.	Series No.	Note
E-1	smartphone	N6000	N/A	EUT

Item	Shielded Type	Ferrite Core	Length	Note

Note:

- (1) The support equipment was authorized by Declaration of Confirmation.
- (2) For detachable type I/O cable should be specified the length in cm in 『Length』 column.
- (3) “YES” means “shielded” or “with ferrite core”; “NO” means “unshielded” or “without ferrite core”

2.5 EQUIPMENTS LIST FOR ALL TEST ITEMS

Item	Kind of Equipment	Manufacturer	Type No.	Serial No.	Last calibration	Calibrated until	Calibration period
1	Spectrum Analyzer	Agilent	E4407B	160400005	2023.03.31	2024.03.30	1 year
2	Test Receiver	R&S	ESPI7	101318	2023.03.27	2024.03.26	1 year
3	Bilog Antenna	TESEQ	CBL6111D	31216	2023.03.16	2024.03.17	1 year
4	50Ω Coaxial Switch	Anritsu	MP59B	6200983705	2023.05.06	2026.05.05	3 year
5	Spectrum Analyzer	ADVANTES T	R3132	150900201	2022.06.16	2023.06.15	1 year
6	Horn Antenna	EM	EM-AH-20180	2011071402	2023.03.31	2024.03.30	1 year
7	Horn Ant	Schwarzbeck	BBHA 9170	9170-181	2023.01.12	2024.01.12	1 year
8	Pre-Amplifier	EMC	EMC051835SE	980246	2022.06.17	2023.06.16	1 year
9	Loop Antenna	ARA	PLA-2030/B	1029	2022.06.17	2023.06.16	1 year
10	USB RF Power Sensor	DARE	RPR3006W	15I00041SN O84	2022.06.17	2023.06.16	1 year
11	Signal Generator	R&S	SMT 06	832080/007	2022.06.16	2023.06.15	1 year
12	Temperature & Humidity Chamber	GIANT FORCE	GTH-056P	GF-94454-1	2022.06.17	2023.06.16	1 year
13	Power Sensor	R&S	URV5-Z4	0395.1619.05	2022.06.17	2023.06.16	1 year
14	MXA Signal Analyzer	Agilent	N9020A	MY49100060	2022.06.16	2023.06.15	1 year
15	LTE Wireless Communications Test Set	R&S	CMW500	1100.008.02	2022.06.16	2023.06.15	1 year
16	MXG Vector Signal Generator	Agilent	N5182A	MY47070317	2022.06.16	2023.06.15	1 year
17	Power Splitter	Mini-Circuits	ZN2PD-63-S	SF025101618	2022.06.17	2023.06.16	1 year

3. RECEIVER BLOCKING

3.1 APPLIED PROCEDURES / LIMIT

The limits please refer to ETSI EN 303 413 V1.2.1 (2021-04) V4.2.1.2.

Clause	Test Item	Limit
4.2.1	RECEIVER BLOCKING	$\Delta C/N_0 \leq 1$ dB

3.2 TEST FREQUENCY & SIGNAL

According to ETSI EN 303 413 V1.2.1 the test wanted signal please see the below Table B-1, And the unwanted signal please see the Table 4-1, Table 4-2, Table 4-4.

Table 4-1: GNSS constellations, GNSS signals and RNSS frequency bands

GNSS Constellation	GNSS Signal Designations	RNSS Frequency Band (MHz)
BDS	B1I	1 559 to 1 610
	B1C	1 559 to 1 610
Galileo	E1	1 559 to 1 610
	E5a	1 164 to 1 215
	E5b	1 164 to 1 215
	E6	1 215 to 1 300
GLONASS	G1	1 559 to 1 610
	G2	1 215 to 1 300
GPS	L1 C/A	1 559 to 1 610
	L1C	1 559 to 1 610
	L2C	1 215 to 1 300
	L5	1 164 to 1 215
SBAS	L1	1 559 to 1 610
	L5	1 164 to 1 215

Table 4-2: Frequency bands, adjacent frequency signal test point centre frequencies and power levels for the 1 559 MHz to 1 610 MHz RNSS band

Frequency band (MHz)	Test point centre frequency (MHz)	Adjacent frequency signal power level (dBm)	Comments
1 518 to 1 525	1 524	-65	MSS (space-to-Earth) band
1 525 to 1 549	1 548	-95	MSS (space-to-Earth) band
1 549 to 1 559	1 554	-105	MSS (space-to-Earth) band
1 559 to 1 610	GUE RNSS band under test		
1 610 to 1 626	1 615	-105	MSS (Earth-to-space) band
1 626 to 1 640	1 627	-85	MSS (Earth-to-space) band

Table 4-3: Frequency bands, blocking signal test point centre frequencies and power levels for the 1 164 MHz to 1 300 MHz RNSS band

Frequency band (MHz)	Test point centre frequency (MHz)	Blocking signal power level (dBm)	Comments
960 to 1 164	1 154	-75	AM(R)S, ARNS band
1 164 to 1 215	GUE RNSS band under test		
1 215 to 1 260	GUE RNSS band under test		
1 260 to 1 300	GUE RNSS band under test		
1 300 to 1 350	1 310	-85	Radiolocation, ARNS, RNSS (Earth-to-space) band

Table 4-4: Blocking signal

Parameter	Value	Comments
Frequency	See table 4-2 and table 4-3	
Power level	See table 4-2 and table 4-3	
Bandwidth	1 MHz	See clause B.1 for details
Format	AWGN	

Table B-1: Signal power levels for each GNSS signal within each GNSS constellation supported

GNSS constellation	GNSS signal	Signal power level (note)
BDS	B1I	-133 dBm
	B1C (IGSO)	-131 dBm
	B1C (MEO)	-129 dBm
Galileo	E1	-127 dBm
	E5a	-125 dBm
	E5b	-125 dBm
	E6	-125 dBm
GLONASS	G1	-131 dBm
	G2	-137 dBm
GPS	L1 C/A	-128,5 dBm
	L1C	-127 dBm
	L2C	-130 dBm
	L5	-124,9 dBm
SBAS	L1	-131 dBm
	L5	-127,5 dBm

NOTE: The signal power levels represent the total signal power of the satellite per channel, not for example pilot and data channels separately.

3.3 TEST PROCEDURE

According to ETSI EN 303 413 V1.2.1 Clause 5.4& Annex B.2.

Measurement	
<input checked="" type="checkbox"/> Conducted measurement	<input type="checkbox"/> Radiated measurement

- 1) Configure the GNSS signal generator to simulate those GNSS and GNSS signals from table 4-1 declared as supported by the GUE, with power levels and other details as specified in clause B.2.
- 2) With the adjacent frequency signal switched off, the EUT shall be given sufficient time to acquire all simulated satellites from the declared GNSS system(s).
- 3) Record the baseline C/N_0 value(s) reported by the EUT. Sufficient filtering shall be used to obtain a stable value. C/N_0 may be averaged across all the satellites in view for each GNSS constellation. However, C/N_0 shall not be averaged across satellite signals in different GNSS constellations. For a multi-GNSS EUT, there shall be a separate C/N_0 value recorded for each GNSS constellation and each GNSS signal supported.
- 4) The adjacent frequency signal generator shall be configured to generate the signal defined in table 4-4, at the first test point centre frequency and signal power level as specified in table 4-2.
- 5) The adjacent frequency signal shall be switched on, and the EUT's C/N_0 value(s) recorded as in step 3) to measure the degradation with respect to the baseline value(s) recorded in step 3).
- 6) Test point Pass/Fail Criteria: If the C/N_0 degradation from step 5) does not exceed the value in equation 4-1, then this test point is set to "pass". If the C/N_0 degradation exceeds the value in equation 4-1, then this test point is set to "fail." For a multi-GNSS and multi-signal EUT, there shall be a separate pass/fail determination for each GNSS and for each GNSS signal supported. If the C/N_0 degradation exceeds the value in equation 4-1 for any supported GNSS or supported GNSS signal, then this test point is set to "fail".
- 7) Step 1) through step 6) shall be repeated for all test point centre frequencies (and associated signal power level) specified in table 4-2.

3.4 TEST SETUP

Please see the below figure 5-1:

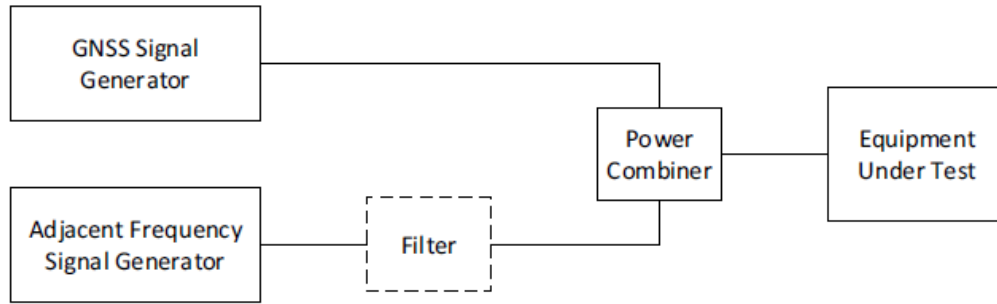

Figure 5-1: Conducted measurement setup for EUT adjacent frequency band selectivity

3.5 TEST RESULTS

EUT :	smartphone	Model Name :	N6000
Temperature :	26°C	Relative Humidity :	60 %
Pressure :	1012 hPa	Test Voltage :	DC 3.87V
Test Mode :	GPS RX		

Test point centre frequency	signal power level	C/N ₀ value (adjacent frequency signal switched off)	C/N ₀ value (adjacent frequency signal switched on)	Δ C/N ₀	Limit(Δ C/N ₀)	Results
(MHz)	(dBm)				(dB)	(P/F)
1575.42	-128.5					
1524	-65	34.57	34.59	0.02	≤ 1 dB	PASS
1548	-95	33.58	33.56	0.02	≤ 1 dB	PASS
1554	-105	33.56	33.43	0.13	≤ 1 dB	PASS
1615	-105	33.74	33.53	0.21	≤ 1 dB	PASS
1627	-85	32.45	32.17	0.28	≤ 1 dB	PASS

Note: We test the C/N0 value for each GNSS, but the report just reported the worst Δ C/N₀ values.

4. SPURIOUS EMISSIONS

4.1 APPLIED PROCEDURES / LIMIT

The limits please refer to ETSI EN 303 413 V1.2.1 (2021-04) clause 4.2.2.2.

Table 4-5: Spurious emission limits

Frequency range	Maximum power	Bandwidth
30 MHz to 1 GHz	-57 dBm	100 kHz
1 GHz to 8,3 GHz	-47 dBm	1 MHz

4.2 TEST PROCEDURES

According to ETSI EN 303 413 V1.2.1 Clause 5.5.

Measurement	
<input type="checkbox"/> Conducted measurement	<input checked="" type="checkbox"/> Radiated measurement

The test site as described in ETSI EN 300 328 [1], annex B and the applicable measurement procedures as described in ETSI EN 300 328 [1], annex C shall be used.

The test procedure is further described in clause 5.5.2.1.

4.3 TEST SETUP

(A) Radiated Emission Test Set-Up Frequency Below 1 GHz

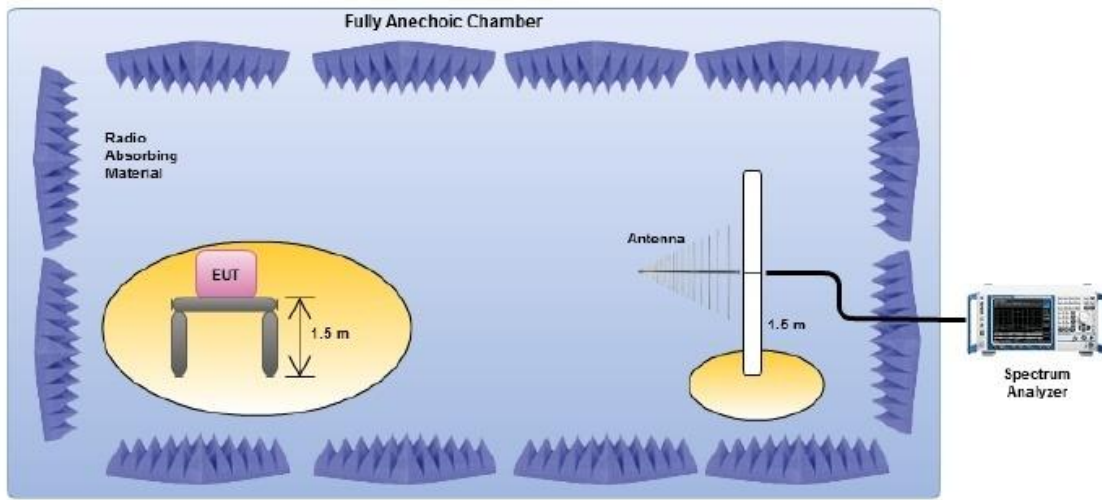

(B) Radiated Emission Test Set-Up Frequency Above 1GHz

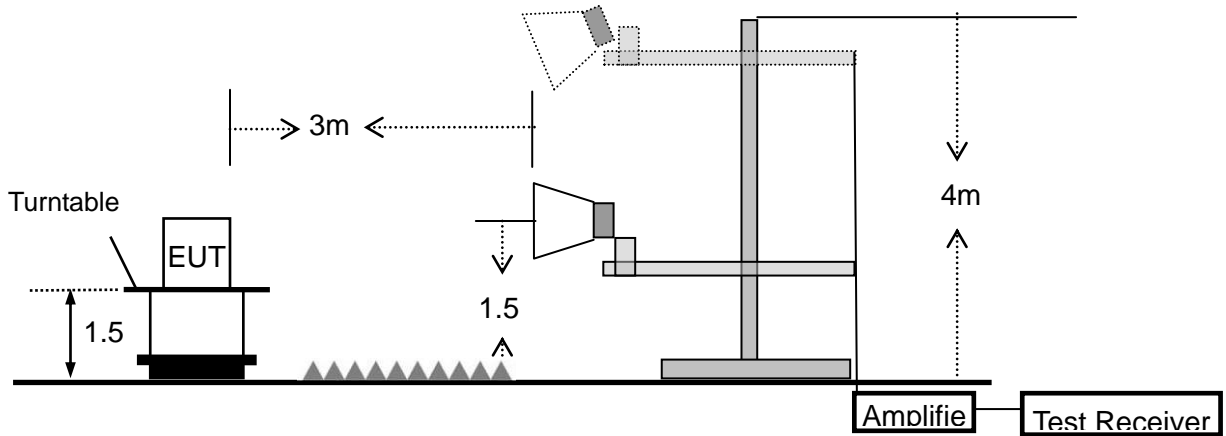

4.4 EUT OPERATION DURING TEST

The EUT was programmed to be in receiving mode.

4.5 TEST RESULTS (30MHZ ~ 1000MHz)

EUT :	smartphone	Model Name :	N6000
Temperature :	24 °C	Relative Humidity :	54%
Pressure :	1010 hPa	Test Power :	DC 3.87V
Test Mode :	Mode 1		

Polar (H/V)	Frequency	Meter Reading	Factor	Emission Level	Limits	Margin	Remark
	(MHz)	(dBm)	(dB)	(dBm)	(dBm)	(dB)	
V	36.701	-80.95	12.25	-68.70	-57	-11.70	peak
V	96.481	-80.8	16.13	-64.67	-57	-7.67	peak
V	187.402	-81.75	14.05	-67.70	-57	-10.70	peak
V	398.194	-80.51	17.01	-63.50	-57	-6.50	peak
V	673.408	-79.96	15.51	-64.45	-57	-7.45	peak
H	39.077	-77.98	14.62	-63.36	-57	-6.36	peak
H	95.553	-81.55	17.87	-63.68	-57	-6.68	peak
H	192.336	-84.03	16.70	-67.33	-57	-10.33	peak
H	405.744	-82.55	15.79	-66.76	-57	-9.76	peak
H	531.006	-78.54	17.54	-61.00	-57	-4.00	peak

Emission Level = Meter Reading + Factor, Margin= Emission Level - Limit
 All the modes had been tested, but only the worst data recorded in the report.

Note: Only the worst case recorded in the report.

4.6 TEST RESULTS (1GHz ~ 8.3GHz)

EUT :	smartphone	Model Name :	N6000
Temperature :	24 °C	Relative Humidity :	54%
Pressure :	1010 hPa	Test Power :	DC 3.87V
Test Mode :	Mode 1		

Polar (H/V)	Frequency	Meter Reading	Factor	Emission Level	Limits	Margin	Detector Type
	(MHz)	(dBm)	(dB)	(dBm)	(dBm)	(dB)	
V	2068.608	-79.49	11.33	-68.16	-47	-21.16	peak
V	4156.356	-79.73	10.97	-68.76	-47	-21.76	peak
V	2051.489	-84.07	10.14	-73.93	-47	-26.93	peak
V	5096.289	-84.43	16.83	-67.60	-47	-20.60	peak
H	2650.768	-77.58	10.52	-67.06	-47	-20.06	peak
H	3479.555	-84.82	11.70	-73.12	-47	-26.12	peak
H	2842.684	-78.72	6.62	-72.10	-47	-25.10	peak
H	5343.163	-81	14.99	-66.01	-47	-19.01	peak

Remark:

Emission Level = Meter Reading + Factor, Margin= Emission Level - Limit

Note: Only the worst case recorded in the report.

5. EUT TEST PHOTO

SPURIOUS EMISSIONS MEASUREMENT PHOTOS

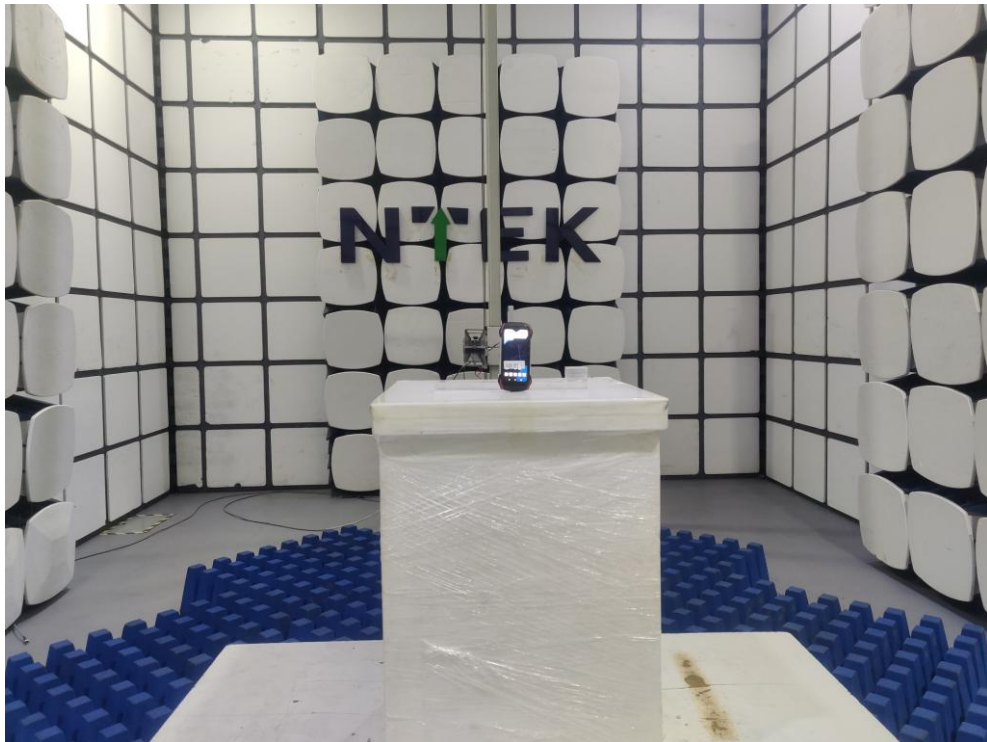

END OF REPORT