EMC Test Report

Report No.: AGC03709200901EE01

PRODUCT DESIGNATION : smartwatch
BRAND NAME : N/A
MODEL NAME : R3 Pro, R1, R2, R3, R5, R6
APPLICANT : Shenzhen Xinhuaajitong Technology Co., Ltd.
DATE OF ISSUE : Sep. 28,2020
STANDARD(S) : ETSI EN 301 489-1 V2.2.3 (2019-11)
: Final draft ETSI EN 301 489-17 V3.2.3 (2020-07)
REPORT VERSION : V1.0

Attestation of Global Compliance (Shenzhen) Co., Ltd



Any report having not been signed by authorized approver, or having been altered without authorization, or having not been stamped by the "Dedicated Testing/Inspection Stamp" is deemed to be invalid. Copying or excerpting portion of, or altering the content of the report is not permitted without the written authorization of AGC. The test results presented in the report apply only to the tested sample. Any objections to report issued by AGC should be submitted to AGC within 15days after the issuance of the test report. Further enquiry of validity or verification of the test report should be addressed to AGC by agc@agc-cert.com.

Attestation of Global Compliance(Shenzhen)Co., Ltd
Attestation of Global Compliance(Shenzhen)Std & Tech Co., Ltd
Tel: +86-755 2523 4088 E-mail: agc@agc-cert.com Web: <http://cn.agc-cert.com/>



REPORT REVISE RECORD

Report Version	Revise Time	Issued Date	Valid Version	Notes
V1.0	/	Sep. 28,2020	Valid	Initial release

Any report having not been signed by authorized approver, or having been altered without authorization, or having not been stamped by the "Dedicated Testing/Inspection Stamp" is deemed to be invalid. Copying or excerpting portion of, or altering the content of the report is not permitted without the written authorization of AGC. The test results presented in the report apply only to the tested sample. Any objections to report issued by AGC should be submitted to AGC within 15days after the issuance of the test report. Further enquiry of validity or verification of the test report should be addressed to AGC by agc@agc-cert.com.

Attestation of Global Compliance(Shenzhen)Co., Ltd
Attestation of Global Compliance(Shenzhen)Std & Tech Co., Ltd
Tel: +86-755 2523 4088 E-mail: agc@agc-cert.com Web: <http://cn.agc-cert.com/>



TABLE OF CONTENTS

1. TEST REPORT CERTIFICATION 6

2. GENERAL INFORMATION 7

 2.1. DESCRIPTION OF EUT 7

 2.2. OBJECTIVE 8

 2.3. TEST STANDARDS AND RESULTS 8

 2.4. TEST ITEMS AND THE RESULTS 8

 2.5. ENVIRONMENTAL CONDITIONS..... 9

3. TEST MODE DESCRIPTION..... 10

4. MEASUREMENT UNCERTAINTY 11

5. SUPPORT EQUIPMENT 11

6. IDENTIFICATION OF THE RESPONSIBLE TESTING LOCATION..... 12

7. RADIATED DISTURBANCE MEASUREMENT 14

 7.1. LIMITS OF RADIATED DISTURBANCES 14

 7.2. TEST PROCEDURE 14

 7.3. BLOCK DIAGRAM OF TEST SETUP 15

 7.4. TEST RESULT 16

8. MAINS TERMINAL DISTURBANCE VOLTAGE MEASUREMENT 20

 8.1. LIMITS OF MAINS TERMINAL DISTURBANCE VOLTAGE..... 20

 8.2. TEST PROCEDURE..... 20

 8.3. TEST SETUP..... 21

 8.4. TEST RESULT..... 21

9. HARMONIC CURRENT MEASUREMENT 24

 9.1. LIMITS OF HARMONIC CURRENT 24

 9.2. TEST PROCEDURE..... 24

 9.3. TEST SETUP..... 25

 9.4. TEST RESULT..... 25

10. VOLTAGE FLUCTUATIONS AND FLICK MEASUREMENT 26

 10.1. LIMITS OF VOLTAGE FLUCTUATIONS AND FLICK..... 26

 10.2. TEST PROCEDURE 26

Any report having not been signed by authorized approver, or having been altered without authorization, or having not been stamped by the "Dedicated Testing/Inspection Stamp" is deemed to be invalid. Copying or excerpting portion of, or altering the content of the report is not permitted without the written authorization of AGC. The test results presented in the report apply only to the tested sample. Any objections to report issued by AGC should be submitted to AGC within 15days after the issuance of the test report. Further enquiry of validity or verification of the test report should be addressed to AGC by agc@agc-cert.com.



10.3. TEST SETUP 26

10.4. TEST RESULT 26

11. IMMUNITY TEST 27

11.1. EUT SETUP AND OPERATING CONDITIONS 27

11.2. GENERAL PERFORMANCE CRITERIA 27

12. ELECTROSTATIC DISCHARGE IMMUNITY TEST 29

12.1 TEST SPECIFICATION 29

12.2 TEST PROCEDURE 29

12.3 TEST SETUP 30

12.4 TEST RESULT 30

12.5 PERFORMANCE 31

13. RADIATED, RADIO FREQUENCY ELECTROMAGNETIC FIELD IMMUNITY TEST 33

13.1. TEST SPECIFICATION 33

13.2. TEST PROCEDURE 33

13.3. TEST SETUP 34

13.4. TEST RESULT 35

13.5. PERFORMANCE 35

14. ELECTRICAL FAST TRANSIENT/BURST IMMUNITY TEST 36

14.1. TEST SPECIFICATION 36

14.2. TEST PROCEDURE 36

14.3. TEST SETUP 36

14.4. TEST RESULT 37

14.5. PERFORMANCE 37

15. SURGE IMMUNITY TEST 38

15.1. TEST SPECIFICATION 38

15.2. TEST PROCEDURE 38

15.3. TEST SETUP 38

15.4. TEST RESULT 39

15.5. PERFORMANCE 39

16. IMMUNITY TO CONDUCTED DISTURBANCES INDUCED BY RF FIELDS 40

16.1. TEST SPECIFICATION 40

16.2. TEST PROCEDURE 40

Any report having not been signed by authorized approver, or having been altered without authorization, or having not been stamped by the "Dedicated Testing/Inspection Stamp" is deemed to be invalid. Copying or excerpting portion of, or altering the content of the report is not permitted without the written authorization of AGC. The test results presented in the report apply only to the tested sample. Any objections to report issued by AGC should be submitted to AGC within 15days after the issuance of the test report. Further enquiry of validity or verification of the test report should be addressed to AGC by agc@agc-cert.com.



16.3. TEST SETUP..... 40

16.4. TEST RESULT..... 41

16.5. PERFORMANCE..... 41

17. VOLTAGE DIPS AND SHORT INTERRUPTIONS IMMUNITY TEST 42

17.1. TEST SPECIFICATION..... 42

17.2. TEST PROCEDURE 42

17.3. TEST SETUP..... 42

17.4. TEST RESULT..... 43

17.5. PERFORMANCE..... 43

APPENDIX A: PHOTOGRAPHS OF TEST SETUP 44

APPENDIX B: PHOTOGRAPHS OF EUT 44

Any report having not been signed by authorized approver, or having been altered without authorization, or having not been stamped by the "Dedicated Testing/Inspection Stamp" is deemed to be invalid. Copying or excerpting portion of, or altering the content of the report is not permitted without the written authorization of AGC. The test results presented in the report apply only to the tested sample. Any objections to report issued by AGC should be submitted to AGC within 15days after the issuance of the test report. Further enquiry of validity or verification of the test report should be addressed to AGC by agc@agc-cert.com.



1. TEST REPORT CERTIFICATION

Applicant	Shenzhen Xinhuaajitong Technology Co., Ltd.
Address	802, Building 3, No. 7 Industrial Zone, Yulu Community, Yutang Street, Guangming District, Shenzhen
Manufacturer	Shenzhen Xinhuaajitong Technology Co., Ltd.
Address	802, Building 3, No. 7 Industrial Zone, Yulu Community, Yutang Street, Guangming District, Shenzhen
Factory	Shenzhen Xinhuaajitong Technology Co., Ltd.
Address	802, Building 3, No. 7 Industrial Zone, Yulu Community, Yutang Street, Guangming District, Shenzhen
Product Designation	smartwatch
Brand Name	N/A
Test Model	R3 Pro
Series Model	R1, R2, R3, R5, R6
Difference Description	All the same except for the model name.
Date of test	Sep. 04,2020 to Sep. 28,2020
Deviation	None
Condition of Test Sample	Normal
Test Result	Pass
Report Template	AGCRT-EC-EMC

We, Attestation of Global Compliance (Shenzhen) Co., Ltd., hereby certify that the submitted samples of the above item, as detailed in chapter 2.1 of this report, has been tested in our facility. The test record, data evaluation and test configuration represented herein are true and accurate accounts of measurements of the sample's EMC characteristics under the conditions herein specified.

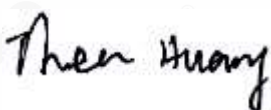
Prepared By 

Thea Huang
Project Engineer
Sep. 28,2020

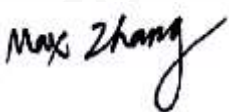
Reviewed By 

Max Zhang
Reviewer
Sep. 28,2020

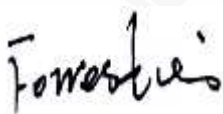
Approved By 

Forrest Lei
Authorized Officer
Sep. 28,2020

Any report having not been signed by authorized approver, or having been altered without authorization, or having not been stamped by the "Dedicated Testing/Inspection Stamp" is deemed to be invalid. Copying or excerpting portion of, or altering the content of the report is not permitted without the written authorization of AGC. The test results presented in the report apply only to the tested sample. Any objections to report issued by AGC should be submitted to AGC within 15days after the issuance of the test report. Further enquiry of validity or verification of the test report should be addressed to AGC by agc@agc-cert.com.



2. GENERAL INFORMATION

2.1. DESCRIPTION OF EUT

The EUT is a short range, lower power, Bluetooth device.

It is designed by way of FHSS modulation achieves the system operating.

Details of technical specification refer to the description in follows:

Transmitter/Receiver (TX/RX)

Operating Frequency	2.402 GHz to 2.480GHz
Bluetooth Version	V5.0
Modulation	BLE <input checked="" type="checkbox"/> GFSK 1Mbps <input checked="" type="checkbox"/> GFSK 2Mbps
Hardware Version	RH112T-V01
Software Version	RH112TG1378
Antenna designation	PIFA Antenna
Number of channels	40 Channels
Antenna Gain	0dBi
Power Supply	DC 3.8V by battery or DC 5V by adapter

Note: The EUT doesn't support BR/EDR.

Any report having not been signed by authorized approver, or having been altered without authorization, or having not been stamped by the "Dedicated Testing/Inspection Stamp" is deemed to be invalid. Copying or excerpting portion of, or altering the content of the report is not permitted without the written authorization of AGC. The test results presented in the report apply only to the tested sample. Any objections to report issued by AGC should be submitted to AGC within 15days after the issuance of the test report. Further enquiry of validity or verification of the test report should be addressed to AGC by agc@agc-cert.com.

Attestation of Global Compliance(Shenzhen)Co., Ltd
Attestation of Global Compliance(Shenzhen)Std & Tech Co., Ltd
Tel: +86-755 2523 4088 E-mail: agc@agc-cert.com Web: http://cn.agc-cert.com/



2.2. OBJECTIVE

Perform Electro Magnetic Interference (EMI) and Electro Magnetic Susceptibility (EMS) tests for CE Marking.

2.3. TEST STANDARDS AND RESULTS

The EUT has been tested according to ETSI EN 301 489-1 V2.2.3 (2019-11) and Final draft ETSI EN 301 489-17 V3.2.3 (2020-07).

ETSI EN 301 489-1	ElectroMagnetic Compatibility (EMC) standard for radio equipment and services; Part 1: Common technical requirements; Harmonised Standard for ElectroMagnetic Compatibility.
ETSI EN 301 489-17	ElectroMagnetic Compatibility (EMC) standard for radio equipment and services; Part 17: Specific conditions for Broadband Data Transmission Systems; Harmonised Standard covering the essential requirements of article 3.1(b) of Directive 2014/53/EU

2.4. TEST ITEMS AND THE RESULTS

No.	Basic Standard	Test Type	Result
EMISSION (EN 301 489-1 §7.1)			
1	EN 55032	Radiated emission	PASS
2	EN 55032	Conducted emission, AC ports	PASS
3	EN 55032	Conducted emission, Telecom ports	N/A
4	EN 61000-3-2	Harmonic current emissions	N/A
5	EN 61000-3-3	Voltage fluctuations & flicker	PASS
IMMUNITY (EN 301 489-1 §7.2)			
6	EN 61000-4-2	Electrostatic discharge immunity	PASS
7	EN 61000-4-3	Radiated RF electromagnetic field immunity	PASS
8	EN 61000-4-4	Electrical fast transient/burst immunity	PASS
9	ISO 7637-1, -2	Transients and surges, DC ports	N/A
10	EN 61000-4-5	Surge immunity, AC ports, Telecom ports	PASS
11	EN 61000-4-6	Immunity to conducted disturbances induced by RF fields	PASS
12	EN 61000-4-11	Voltage dips and short interruptions immunity	PASS

Note: 1. N/A- Not Applicable.

2. The latest versions of basic standards are applied.

Any report having not been signed by authorized approver, or having been altered without authorization, or having not been stamped by the "Dedicated Testing/Inspection Stamp" is deemed to be invalid. Copying or excerpting portion of, or altering the content of the report is not permitted without the written authorization of AGC. The test results presented in the report apply only to the tested sample. Any objections to report issued by AGC should be submitted to AGC within 15 days after the issuance of the test report. Further enquiry of validity or verification of the test report should be addressed to AGC by agc@agc-cert.com.



2.5. ENVIRONMENTAL CONDITIONS

During the measurement the environmental conditions were within the listed ranges:

- Temperature: 15-35°C
- Relative humidity: 30-60 %
- Atmospheric pressure: 86-106 kPa

Any report having not been signed by authorized approver, or having been altered without authorization, or having not been stamped by the "Dedicated Testing/Inspection Stamp" is deemed to be invalid. Copying or excerpting portion of, or altering the content of the report is not permitted without the written authorization of AGC. The test results presented in the report apply only to the tested sample. Any objections to report issued by AGC should be submitted to AGC within 15 days after the issuance of the test report. Further enquiry of validity or verification of the test report should be addressed to AGC by agc@agc-cert.com.

Attestation of Global Compliance(Shenzhen)Co., Ltd
Attestation of Global Compliance(Shenzhen)Std & Tech Co., Ltd
Tel: +86-755 2523 4088 E-mail: agc@agc-cert.com Web: <http://cn.agc-cert.com/>



3. TEST MODE DESCRIPTION

TEST MODE DESCRIPTION		
NO.	EMI TEST MODE DESCRIPTION	WORST
1	Standby with charging	V
2	BT Link	-
NO.	EMS TEST MODE DESCRIPTION	WORST
1	Standby with charging	V
2	BT Link	-

Note: 1. V means EMI worst mode.
2. All modes have been tested and only the worst mode test data recorded in the test report.

I/O Port Information (Applicable Not Applicable)

I/O Port of EUT			
I/O Port Type	Number	Cable Description	Tested With
Charging Port	1	0.6m unshielded	1

Note: All the above "--" means that EUT has no cable.

Any report having not been signed by authorized approver, or having been altered without authorization, or having not been stamped by the "Dedicated Testing/Inspection Stamp" is deemed to be invalid. Copying or excerpting portion of, or altering the content of the report is not permitted without the written authorization of AGC. The test results presented in the report apply only to the tested sample. Any objections to report issued by AGC should be submitted to AGC within 15days after the issuance of the test report. Further enquiry of validity or verification of the test report should be addressed to AGC by agc@agc-cert.com.



4. MEASUREMENT UNCERTAINTY

The uncertainty is calculated using the methods suggested in the “Guide to the Expression of Uncertainty in measurement” (GUM) published by CISPR and ANSI.

- Uncertainty of Radiated Emission, $U_c = \pm 3.1 \text{ dB}$
- Uncertainty of Radiated Emission below 1GHz, $U_c = \pm 4.0 \text{ dB}$
- Uncertainty of Radiated Emission above 1GHz, $U_c = \pm 4.8 \text{ dB}$

5. SUPPORT EQUIPMENT

Device Type	Manufacturer	Model Name	Data Cable
Mobile phone	TCL	J326T	--
Adapter	Zhongli	ZL-PCB0100020502000	--

Note: 1. "--" means no any support device during testing.
2. All the cables were provided by AGC Lab.

Any report having not been signed by authorized approver, or having been altered without authorization, or having not been stamped by the “Dedicated Testing/Inspection Stamp” is deemed to be invalid. Copying or excerpting portion of, or altering the content of the report is not permitted without the written authorization of AGC. The test results presented in the report apply only to the tested sample. Any objections to report issued by AGC should be submitted to AGC within 15days after the issuance of the test report. Further enquiry of validity or verification of the test report should be addressed to AGC by agc@agc-cert.com.

Attestation of Global Compliance(Shenzhen)Co., Ltd
Attestation of Global Compliance(Shenzhen)Std & Tech Co., Ltd
Tel: +86-755 2523 4088 E-mail: agc@agc-cert.com Web: <http://cn.agc-cert.com/>



6. IDENTIFICATION OF THE RESPONSIBLE TESTING LOCATION

Site	Attestation of Global Compliance (Shenzhen) Co., Ltd
Location	1-2/F, Building 19, Junfeng Industrial Park, Chongqing Road, Heping Community, Fuhai Street, Bao'an District, Shenzhen, Guangdong, China

TEST EQUIPMENT OF CONDUCTED EMISSION TEST

Equipment	Manufacturer	Model	S/N	Cal. Date	Cal. Due
Test Receiver	R&S	ESCI	10096	May 15, 2020	May 14,2021
LISN	R&S	ESH2-Z5	100086	Jul. 03,2020	Jul. 02,2021

TEST EQUIPMENT OF RADIATED EMISSION TEST

Equipment	Manufacturer	Model	S/N	Cal. Date	Cal. Due
Test Receiver	R&S	ESCI	10096	May 15, 2020	May 14,2021
ANTENNA	SCHWARZBECK	VULB9168	494	Jan. 09,2019	Jan. 08,2021
Double-Ridged Waveguide Horn	ETS LINDGREN	3117	00034609	May. 17, 2019	May. 16, 2021
EXA Signal Analyzer	Aglient	N9010A	MY53470504	Dec. 12, 2019	Dec.11, 2020

TEST EQUIPMENT OF ESD TEST

Equipment	Manufacturer	Model	S/N	Cal. Date	Cal. Due
ESD Simulator	EM Test	NSG 438	782	Jan. 10, 2020	Jan. 09, 2022

TEST EQUIPMENT OF POWER HARMONICS / VOLTAGE FLUCTUATION / FLICKER TEST

Equipment	Manufacturer	Model	S/N	Cal. Date	Cal. Due
Signal Conditioning Unit	Schaffner	CCN1000-1	72431	Jul. 15,2020	Jul. 14,2022
AC Source	Schaffner	NSG 1007	56825	Jul. 15,2020	Jul. 14,2022

TEST EQUIPMENT OF SURGE/EFT/DIPSTEST

Equipment	Manufacturer	Model	S/N	Cal. Date	Cal. Due
EFT Surge Generator	Schaffner	Modula 6150	34437	Jul. 03,2020	Jul. 02,2022

Any report having not been signed by authorized approver, or having been altered without authorization, or having not been stamped by the "Dedicated Testing/Inspection Stamp" is deemed to be invalid. Copying or excerpting portion of, or altering the content of the report is not permitted without the written authorization of AGC. The test results presented in the report apply only to the tested sample. Any objections to report issued by AGC should be submitted to AGC within 15days after the issuance of the test report. Further enquiry of validity or verification of the test report should be addressed to AGC by agc@agc-cert.com.



TEST EQUIPMENT OF RS IMMUNITY TEST

Equipment	Manufacturer	Model	S/N	Cal. Date	Cal. Due
Signal Generator	R&S	E4421B	MY43351603	Jun. 08, 2020	Jun. 07, 2022
POWER SENSOR	R&S	URV5-Z4	100124	May 22, 2020	May 21, 2022
POWER METER	R&S	NRVD	8323781027	May 22, 2020	May 21, 2022
POWER AMPLIFIER	KALMUS	7100LC	04-02/17-06-001	N/A	N/A
RF AMPLIFIER	Milmega	AS0104-55_55	1004793	N/A	N/A
Double-Ridged Waveguide Horn	ETS LINDGREN	3117	00034609	May 17, 2019	May 16, 2021
ANTENNA	SCHWARZBECK	VULB9168	494	Jan. 09,2019	Jan. 08,2021

TEST EQUIPMENT OF CS IMMUNITY TEST

Equipment	Manufacturer	Model	S/N	Cal. Date	Cal. Due
Power Amplifier	AR	75A250	18464	N/A	N/A
CDN	ZHINAN	ZN3751	15004	Sep. 03, 2020	Sep. 02, 2022
6dB attenuator	ZHINAN	E-002	N/A	Sep. 03, 2020	Sep. 02, 2022
Electromagnetic Injection Clamp	Luthi	EM101	35773	Aug. 25,2020	Aug. 24,2022
Power Sensor	R&S	URV5-Z4	100124	May 22, 2020	May 21, 2022
Power Meter	R&S	NRVD	8323781027	May 22, 2020	May 21, 2022
SIGNAL GENERATOR	R&S	E4421B	MY43351603	Jun. 08, 2020	Jun. 07, 2022

Any report having not been signed by authorized approver, or having been altered without authorization, or having not been stamped by the "Dedicated Testing/Inspection Stamp" is deemed to be invalid. Copying or excerpting portion of, or altering the content of the report is not permitted without the written authorization of AGC. The test results presented in the report apply only to the tested sample. Any objections to report issued by AGC should be submitted to AGC within 15days after the issuance of the test report. Further enquiry of validity or verification of the test report should be addressed to AGC by agc@agc-cert.com.



7. RADIATED DISTURBANCE MEASUREMENT

7.1. LIMITS OF RADIATED DISTURBANCES

Limits for radiated disturbance 30M to1 GHz at a measurement distance of 3 m

Frequency range (MHz)	Quasi peak limits(dBuV/m), for Class B ITE, at 3m measurement distance
30 - 230	40
230 - 1000	47

Limits for radiated disturbance above 1 GHz at a measurement distance of 3 m

Frequency range (MHz)	Limits (dBuV/m), Class B ITE	
	Peak	Average
1000-3000MHz	70	50
3000-6000MHz	74	54

Note: 1. The lower limit shall apply at the transition frequency.

2. Additional provisions may be required for cases where interference occurs.

7.2. TEST PROCEDURE

- (1). The EUT was placed on the top of an insulating table 0.8 meters above the ground at a semi-anechoic chamber. The table was rotated 360 degrees to determine the position of the highest radiation.
- (2). The EUT was set 3 meters away from the interference-receiving antenna, which was mounted on the top of a variable-height antenna tower.
- (3).The antenna is a broadband antenna, and its height is varied from 1 to 4 meter above the ground to determine the maximum value of the field strength. Both horizontal and vertical polarizations of the antenna are set to make the measurement.
- (4). For each suspected emission, the EUT was arranged to its worst case and then the antenna was tuned to the heights from 1 to 4 meters and the rotatable table was turned from 0 degrees to 360 degrees to find the maximum reading.

Any report having not been signed by authorized approver, or having been altered without authorization, or having not been stamped by the "Dedicated Testing/Inspection Stamp" is deemed to be invalid. Copying or excerpting portion of, or altering the content of the report is not permitted without the written authorization of AGC. The test results presented in the report apply only to the tested sample. Any objections to report issued by AGC should be submitted to AGC within 15days after the issuance of the test report. Further enquiry of validity or verification of the test report should be addressed to AGC by agc@agc-cert.com.



7.3. BLOCK DIAGRAM OF TEST SETUP
Radiated Disturbance below 1 GHz

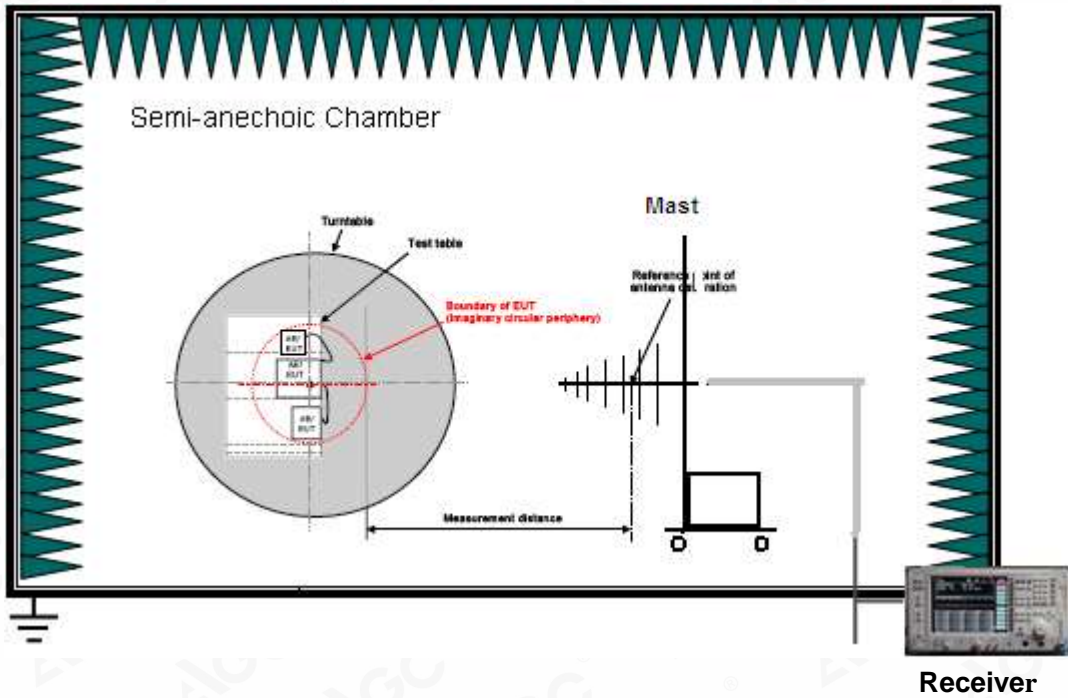

Radiated Disturbance above 1 GHz

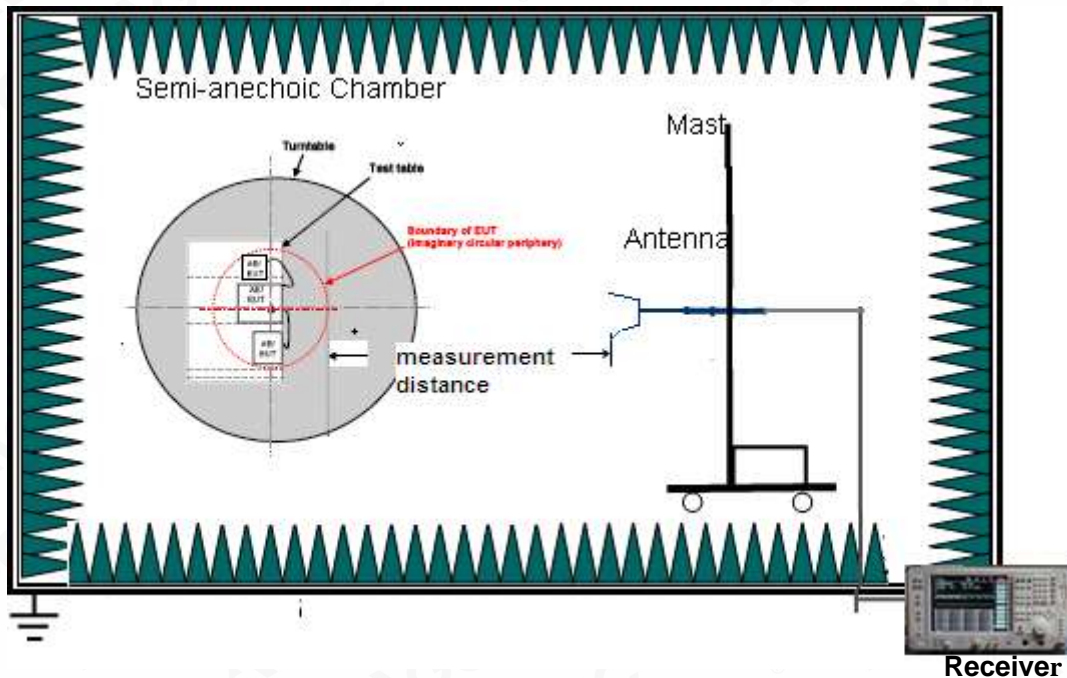

For the actual test configuration, please refer to the related item-Photographs of the Test Configuration.

Any report having not been signed by authorized approver, or having been altered without authorization, or having not been stamped by the "Dedicated Testing/Inspection Stamp" is deemed to be invalid. Copying or excerpting portion of, or altering the content of the report is not permitted without the written authorization of AGC. The test results presented in the report apply only to the tested sample. Any objections to report issued by AGC should be submitted to AGC within 15 days after the issuance of the test report. Further enquiry of validity or verification of the test report should be addressed to AGC by agc@agc-cert.com.



7.4. TEST RESULT

The test modes were carried out for all modes.

The worst test mode of the EUT was Mode 1, and its test data was showed as the follow:

RADIATED EMISSION BELOW 1GHz– HORIZONTAL

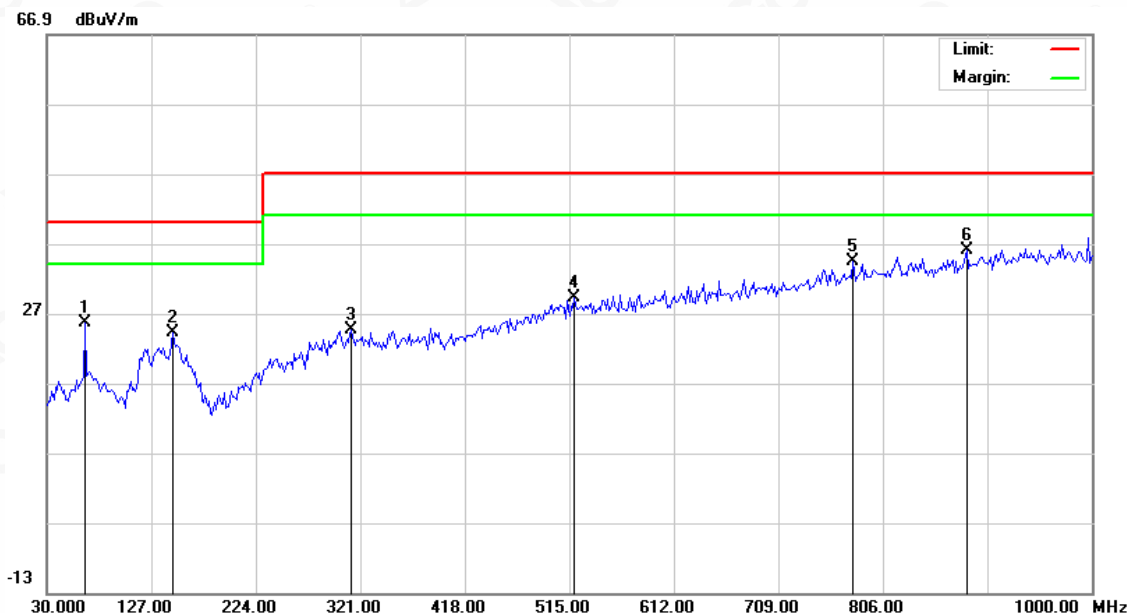

No.	Mk.	Freq. MHz	Reading Level dBuV	Correct Factor dB	Measure- ment dBuV/m	Limit dBuV/m	Over dB	Detector
1		65.5667	9.00	16.56	25.56	40.00	-14.44	peak
2		146.4000	8.38	15.82	24.20	40.00	-15.80	peak
3		312.9166	3.13	21.41	24.54	47.00	-22.46	peak
4		519.8500	3.85	25.38	29.23	47.00	-17.77	peak
5		778.5167	4.57	29.92	34.49	47.00	-12.51	peak
6	*	883.6000	4.53	31.49	36.02	47.00	-10.98	peak

RESULT: PASS

Any report having not been signed by authorized approver, or having been altered without authorization, or having not been stamped by the "Dedicated Testing/Inspection Stamp" is deemed to be invalid. Copying or excerpting portion of, or altering the content of the report is not permitted without the written authorization of AGC. The test results presented in the report apply only to the tested sample. Any objections to report issued by AGC should be submitted to AGC within 15 days after the issuance of the test report. Further enquiry of validity or verification of the test report should be addressed to AGC by agc@agc-cert.com.

Attestation of Global Compliance(Shenzhen)Co., Ltd
Attestation of Global Compliance(Shenzhen)Std & Tech Co., Ltd
Tel: +86-755 2523 4088 E-mail: agc@agc-cert.com Web: http://cn.agc-cert.com/



RADIATED EMISSION BELOW 1GHz- VERTICAL

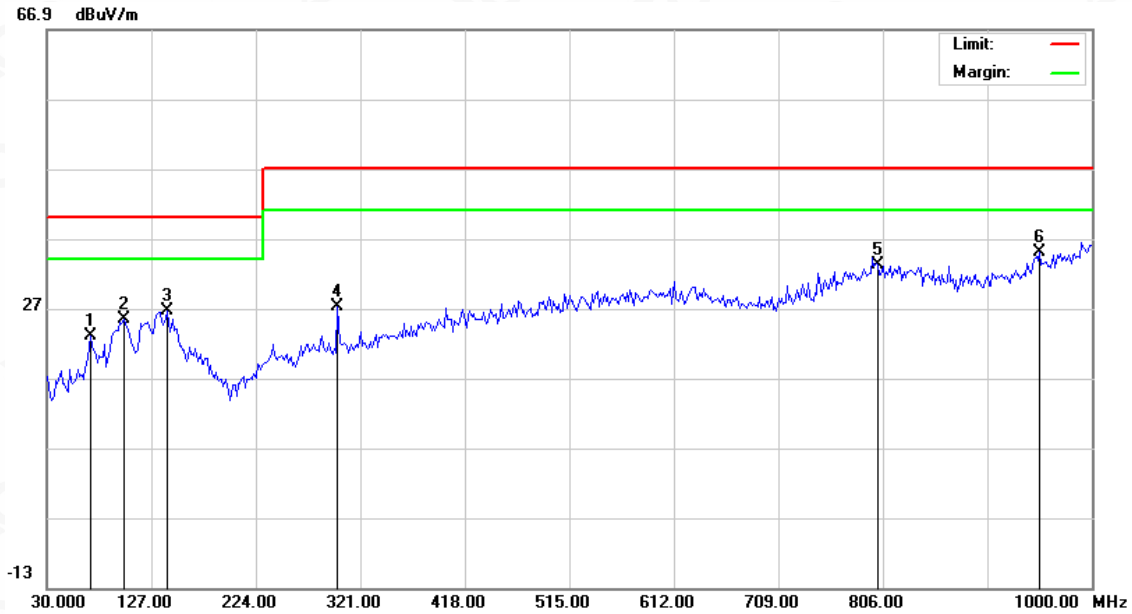

No.	Mk.	Freq. MHz	Reading Level dBuV	Correct Factor dB	Measure- ment dBuV/m	Limit dBuV/m	Over dB	Detector
1		70.4167	5.95	17.02	22.97	40.00	-17.03	peak
2		101.1333	9.34	16.12	25.46	40.00	-14.54	peak
3		141.5500	7.29	19.23	26.52	40.00	-13.48	peak
4		299.9833	7.68	19.47	27.15	47.00	-19.85	peak
5		801.1500	2.83	30.38	33.21	47.00	-13.79	peak
6	*	951.5000	4.74	30.20	34.94	47.00	-12.06	peak

RESULT: PASS

Any report having not been signed by authorized approver, or having been altered without authorization, or having not been stamped by the "Dedicated Testing/Inspection Stamp" is deemed to be invalid. Copying or excerpting portion of, or altering the content of the report is not permitted without the written authorization of AGC. The test results presented in the report apply only to the tested sample. Any objections to report issued by AGC should be submitted to AGC within 15 days after the issuance of the test report. Further enquiry of validity or verification of the test report should be addressed to AGC by agc@agc-cert.com.

Attestation of Global Compliance(Shenzhen)Co., Ltd
Attestation of Global Compliance(Shenzhen)Std & Tech Co., Ltd
Tel: +86-755 2523 4088 E-mail: agc@agc-cert.com Web: http://cn.agc-cert.com/



RADIATED EMISSION ABOVE 1GHz – HORIZONTAL

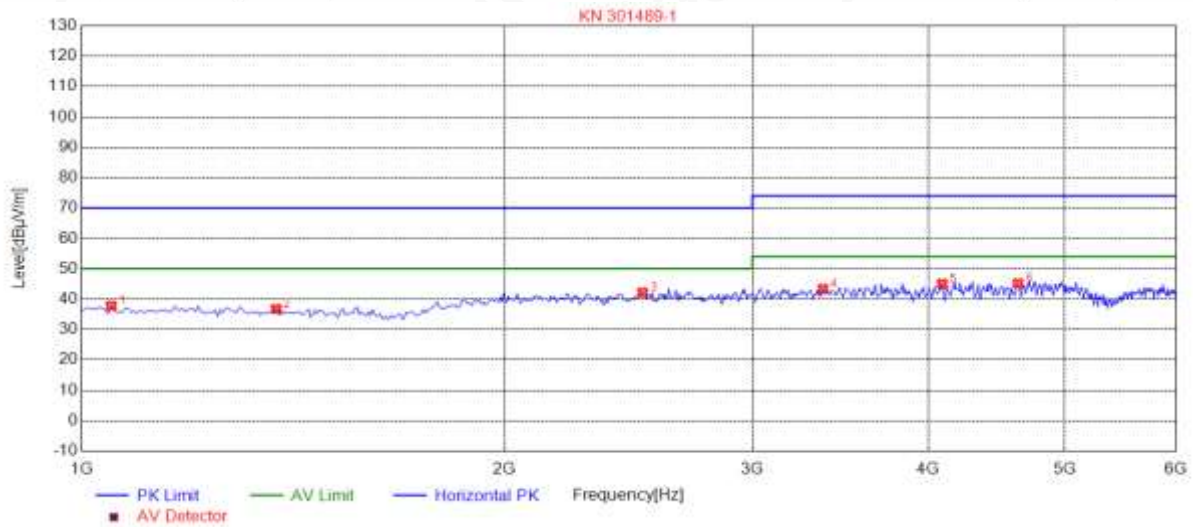

NO.	Freq. [MHz]	Level [dBμV/m]	Factor [dB]	Limit [dBμV/m]	Margin [dB]	Height [cm]	Angle [°]	Polarity
1	1050.0501	37.82	-16.69	70.00	32.18	100	180	Horizontal
2	1375.3754	36.73	-17.01	70.00	33.27	100	250	Horizontal
3	2506.5065	42.16	-9.71	70.00	27.84	100	290	Horizontal
4	3367.3674	43.38	-8.06	74.00	30.62	100	230	Horizontal
5	4093.0931	45.07	-6.26	74.00	28.93	100	260	Horizontal
6	4633.6336	45.20	-5.07	74.00	28.80	100	150	Horizontal

RESULT: PASS

Any report having not been signed by authorized approver, or having been altered without authorization, or having not been stamped by the "Dedicated Testing/Inspection Stamp" is deemed to be invalid. Copying or excerpting portion of, or altering the content of the report is not permitted without the written authorization of AGC. The test results presented in the report apply only to the tested sample. Any objections to report issued by AGC should be submitted to AGC within 15 days after the issuance of the test report. Further enquiry of validity or verification of the test report should be addressed to AGC by agc@agc-cert.com.

Attestation of Global Compliance(Shenzhen)Co., Ltd
Attestation of Global Compliance(Shenzhen)Std & Tech Co., Ltd
Tel: +86-755 2523 4088 E-mail: agc@agc-cert.com Web: http://cn.agc-cert.com/



RADIATED EMISSION ABOVE 1GHz - VERTICAL

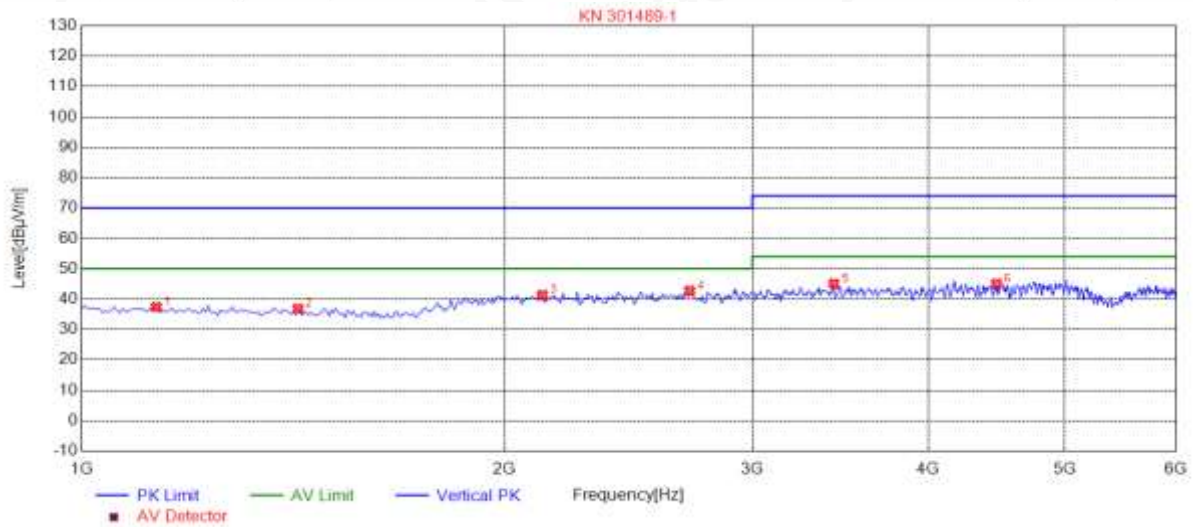

NO.	Freq. [MHz]	Level [dBµV/m]	Factor [dB]	Limit [dBµV/m]	Margin [dB]	Height [cm]	Angle [°]	Polarity
1	1130.1301	37.41	-16.77	70.00	32.59	100	240	Vertical
2	1425.4254	36.83	-17.06	70.00	33.17	100	300	Vertical
3	2126.1261	41.33	-11.29	70.00	28.67	100	180	Vertical
4	2706.7067	42.75	-9.56	70.00	27.25	100	330	Vertical
5	3427.4274	45.09	-7.85	74.00	28.91	100	180	Vertical
6	4473.4735	45.06	-5.27	74.00	28.94	100	20	Vertical

RESULT: PASS

Any report having not been signed by authorized approver, or having been altered without authorization, or having not been stamped by the "Dedicated Testing/Inspection Stamp" is deemed to be invalid. Copying or excerpting portion of, or altering the content of the report is not permitted without the written authorization of AGC. The test results presented in the report apply only to the tested sample. Any objections to report issued by AGC should be submitted to AGC within 15days after the issuance of the test report. Further enquiry of validity or verification of the test report should be addressed to AGC by agc@agc-cert.com.

Attestation of Global Compliance(Shenzhen)Co., Ltd
Attestation of Global Compliance(Shenzhen)Std & Tech Co., Ltd
Tel: +86-755 2523 4088 E-mail: agc@agc-cert.com Web: http://cn.agc-cert.com/



8. MAINS TERMINAL DISTURBANCE VOLTAGE MEASUREMENT

8.1. LIMITS OF MAINS TERMINAL DISTURBANCE VOLTAGE

Frequency range (MHz)	Limits (dBuV) Class B ITE	
	Quasi-peak	Average
0.15 - 0.50	66 to 56	56 to 46
0.50 - 5	56	46
5 - 30	60	50

- Note: 1. The lower limit shall apply at the transition frequencies.
2. The limit decreases linearly with the logarithm of the frequency in the range 0.15MHz to 0.50MHz.

8.2. TEST PROCEDURE

- (1) The EUT was placed 0.4 meters from the conducting wall of shielded room with EUT being connected to the power mains through a line impedance stabilization network (LISN). The LISN provide 50Ω/50μH of coupling impedance for the measuring instrument.
- (2) Both lines of the power mains connected to the EUT were checked for maximum conducted interference.
- (3) The frequency range from 150 kHz to 30 MHz was searched. Emission levels over 20dB under the prescribed limits are not reported.

Any report having not been signed by authorized approver, or having been altered without authorization, or having not been stamped by the "Dedicated Testing/Inspection Stamp" is deemed to be invalid. Copying or excerpting portion of, or altering the content of the report is not permitted without the written authorization of AGC. The test results presented in the report apply only to the tested sample. Any objections to report issued by AGC should be submitted to AGC within 15days after the issuance of the test report. Further enquiry of validity or verification of the test report should be addressed to AGC by agc@agc-cert.com.



8.3. TEST SETUP

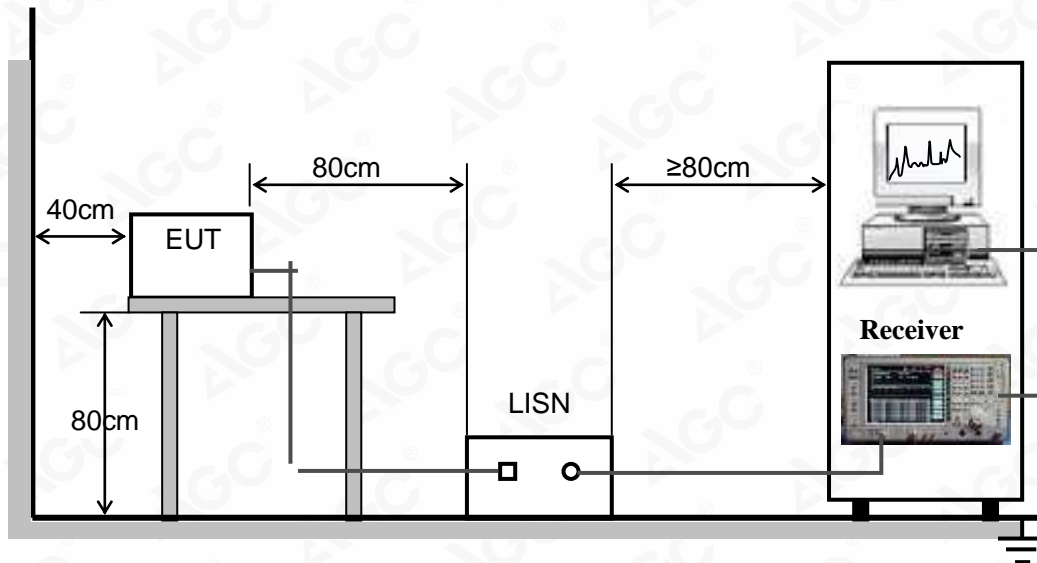

For the actual test configuration, please refer to the related item - Photographs of the Test Configuration.

8.4. TEST RESULT

The test modes were carried out for all modes.

The worst test mode of the EUT was Mode 1, and its test data was showed as the follow:

Any report having not been signed by authorized approver, or having been altered without authorization, or having not been stamped by the "Dedicated Testing/Inspection Stamp" is deemed to be invalid. Copying or excerpting portion of, or altering the content of the report is not permitted without the written authorization of AGC. The test results presented in the report apply only to the tested sample. Any objections to report issued by AGC should be submitted to AGC within 15days after the issuance of the test report. Further enquiry of validity or verification of the test report should be addressed to AGC by agc@agc-cert.com.

Attestation of Global Compliance(Shenzhen)Co., Ltd
Attestation of Global Compliance(Shenzhen)Std & Tech Co., Ltd
Tel: +86-755 2523 4088 E-mail: agc@agc-cert.com Web: http://cn.agc-cert.com/



LINE CONDUCTED EMISSION TEST-L

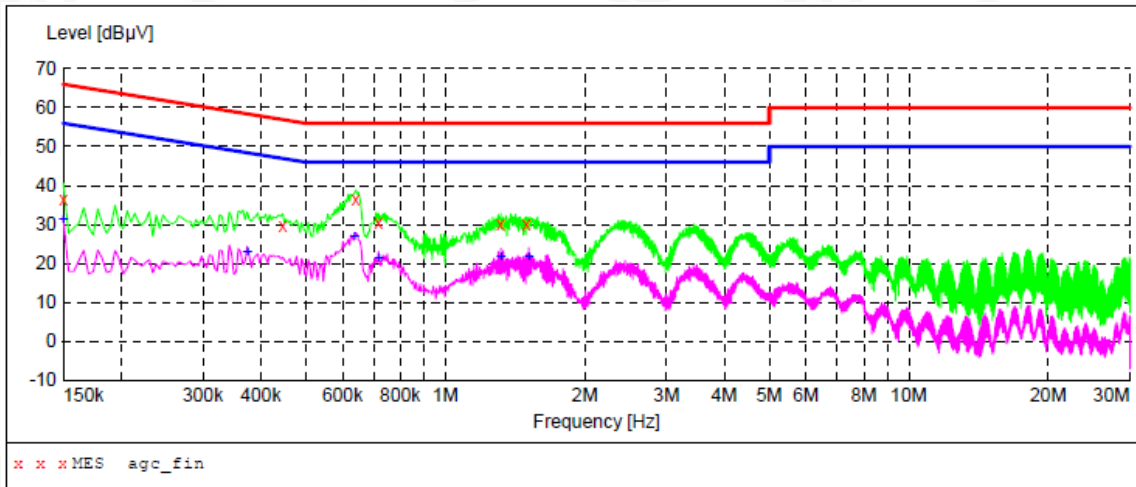

MEASUREMENT RESULT: "agc_fin"

2020/9/5 0:41

Frequency MHz	Level dBµV	Transd dB	Limit dBµV	Margin dB	Detector	Line	PE
0.150000	36.30	9.3	66	29.7	QP	L1	GND
0.446000	29.50	9.3	57	27.4	QP	L1	GND
0.642000	36.60	9.3	56	19.4	QP	L1	GND
0.718000	30.50	9.3	56	25.5	QP	L1	GND
1.318000	29.90	9.3	56	26.1	QP	L1	GND
1.498000	29.90	9.3	56	26.1	QP	L1	GND

MEASUREMENT RESULT: "agc_fin2"

2020/9/5 0:41

Frequency MHz	Level dBµV	Transd dB	Limit dBµV	Margin dB	Detector	Line	PE
0.150000	31.40	9.3	56	24.6	AV	L1	GND
0.374000	22.80	9.3	48	25.6	AV	L1	GND
0.638000	26.80	9.3	46	19.2	AV	L1	GND
0.718000	21.30	9.3	46	24.7	AV	L1	GND
1.318000	21.80	9.3	46	24.2	AV	L1	GND
1.514000	21.80	9.3	46	24.2	AV	L1	GND

Any report having not been signed by authorized approver, or having been altered without authorization, or having not been stamped by the "Dedicated Testing/Inspection Stamp" is deemed to be invalid. Copying or excerpting portion of, or altering the content of the report is not permitted without the written authorization of AGC. The test results presented in the report apply only to the tested sample. Any objections to report issued by AGC should be submitted to AGC within 15 days after the issuance of the test report. Further enquiry of validity or verification of the test report should be addressed to AGC by agc@agc-cert.com.



LINE CONDUCTED EMISSION TEST-N

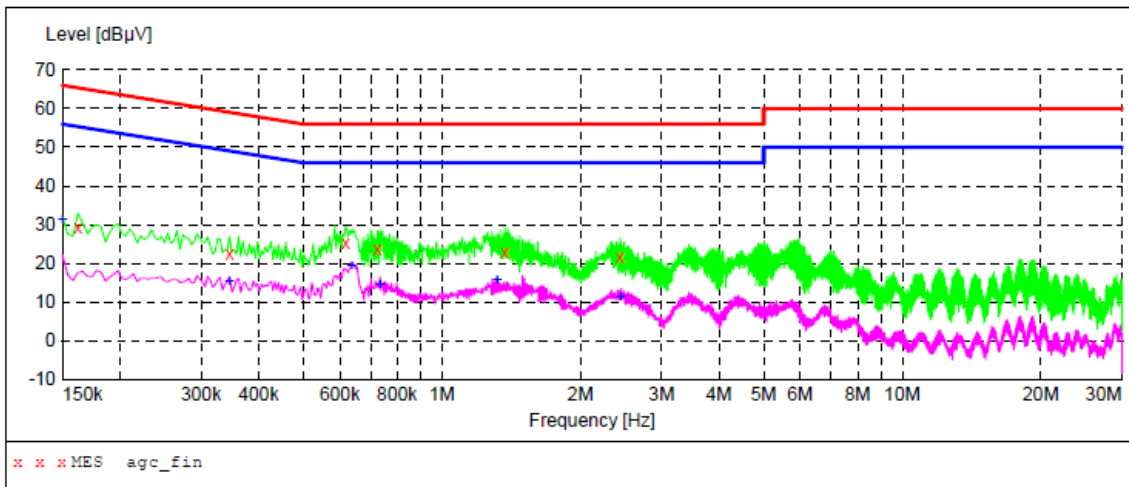

MEASUREMENT RESULT: "agc_fin"

2020/9/5 0:45

Frequency MHz	Level dBµV	Transd dB	Limit dBµV	Margin dB	Detector	Line	PE
0.162000	29.40	9.3	65	36.0	QP	N	GND
0.346000	22.60	9.3	59	36.5	QP	N	GND
0.618000	25.40	9.3	56	30.6	QP	N	GND
0.726000	23.80	9.3	56	32.2	QP	N	GND
1.370000	22.80	9.3	56	33.2	QP	N	GND
2.442000	21.60	9.4	56	34.4	QP	N	GND

MEASUREMENT RESULT: "agc_fin2"

2020/9/5 0:45

Frequency MHz	Level dBµV	Transd dB	Limit dBµV	Margin dB	Detector	Line	PE
0.150000	31.30	9.3	56	24.7	AV	N	GND
0.346000	15.10	9.3	49	34.0	AV	N	GND
0.638000	19.30	9.3	46	26.7	AV	N	GND
0.734000	14.40	9.3	46	31.6	AV	N	GND
1.318000	15.50	9.3	46	30.5	AV	N	GND
2.442000	11.30	9.4	46	34.7	AV	N	GND

Any report having not been signed by authorized approver, or having been altered without authorization, or having not been stamped by the "Dedicated Testing/Inspection Stamp" is deemed to be invalid. Copying or excerpting portion of, or altering the content of the report is not permitted without the written authorization of AGC. The test results presented in the report apply only to the tested sample. Any objections to report issued by AGC should be submitted to AGC within 15 days after the issuance of the test report. Further enquiry of validity or verification of the test report should be addressed to AGC by agc@agc-cert.com.



9. HARMONIC CURRENT MEASUREMENT

9.1. LIMITS OF HARMONIC CURRENT

Limits for Class A Equipment	
Harmonics Order n	Max. permissible harmonic current (A)
Odd harmonics	
3	2.30
5	1.14
7	0.77
9	0.40
11	0.33
13	0.21
$15 \leq n \leq 39$	$0.15 \times 15/n$
Even harmonics	
2	1.08
4	0.43
6	0.30
$8 \leq n \leq 40$	$0.23 \times 8/n$

Note: 1. According to section 5 of EN61000-3-2: 2014, the EUT is Class A equipment.

2. The above limits are for all applications having an active input power >75W. No limits apply for equipment with an active input power up to and including 75W.

9.2. TEST PROCEDURE

- The EUT was placed on the top of a wooden table 0.8 meters above the ground and operated to produce the maximum harmonic components under normal operating conditions for each successive harmonic component in turn.
- The correspondent test program of test instrument to measure the current harmonics emanated from EUT is chosen. The measure time shall be not less than the necessary for the EUT to be exercised.

Any report having not been signed by authorized approver, or having been altered without authorization, or having not been stamped by the "Dedicated Testing/Inspection Stamp" is deemed to be invalid. Copying or excerpting portion of, or altering the content of the report is not permitted without the written authorization of AGC. The test results presented in the report apply only to the tested sample. Any objections to report issued by AGC should be submitted to AGC within 15 days after the issuance of the test report. Further enquiry of validity or verification of the test report should be addressed to AGC by agc@agc-cert.com.



9.3. TEST SETUP

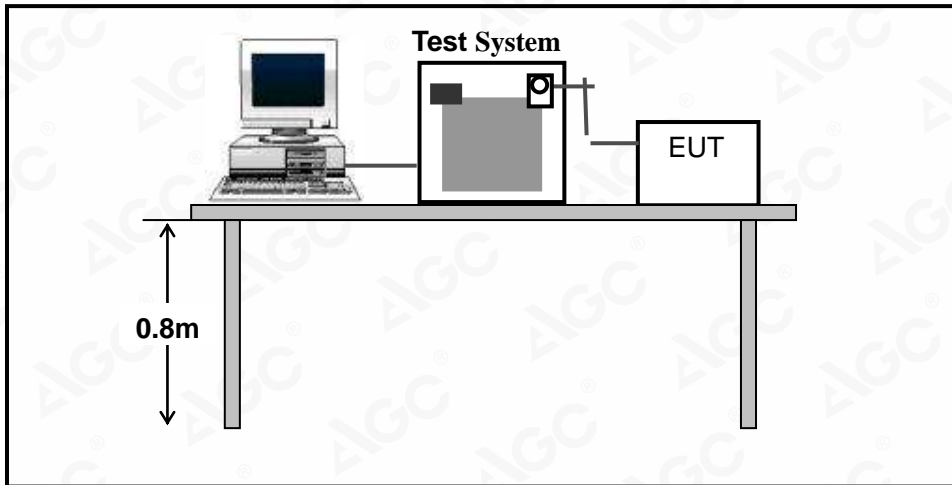

For the actual test configuration, please refer to Appendix I: Photographs of the Test Configuration.

9.4. TEST RESULT

No applicable for equipment with an active input power up to and including 75W.

Any report having not been signed by authorized approver, or having been altered without authorization, or having not been stamped by the "Dedicated Testing/Inspection Stamp" is deemed to be invalid. Copying or excerpting portion of, or altering the content of the report is not permitted without the written authorization of AGC. The test results presented in the report apply only to the tested sample. Any objections to report issued by AGC should be submitted to AGC within 15 days after the issuance of the test report. Further enquiry of validity or verification of the test report should be addressed to AGC by agc@agc-cert.com.

Attestation of Global Compliance(Shenzhen)Co., Ltd
Attestation of Global Compliance(Shenzhen)Std & Tech Co., Ltd
Tel: +86-755 2523 4088 E-mail: agc@agc-cert.com Web: <http://cn.agc-cert.com/>



10. VOLTAGE FLUCTUATIONS AND FLICK MEASUREMENT

10.1. LIMITS OF VOLTAGE FLUCTUATIONS AND FLICK

Test Item	Limit	Note
P_{st}	1.0	P_{st} means Short-term flicker indicator
P_{lt}	0.65	P_{lt} means long-term flicker indicator
T_{dt}	0.5	T_{dt} means maximum time that d_t exceeds 3.3%
$d_{max}(\%)$	4%	d_{max} means maximum relative voltage change.
$d_c(\%)$	3.3%	d_c means relative steady-state voltage change.

10.2. TEST PROCEDURE

1. The EUT was placed on the top of a wooden table 0.8 meters above the ground and operated to produce the most unfavorable sequence of voltage changes under normal conditions
2. During the flick measurement, the measure time shall include that part of whole operation changes. The observation period for short-term flicker indicator is 10 minutes and the observation period for long-term flicker indicator is 2 hours.

10.3. TEST SETUP

Same as 9.3

10.4. TEST RESULT

Test Specification

Test Frequency	50Hz	Test Voltage	230V AC
Waveform	Sine	Test Time	10 minutes(P_{st}); 2 hours (P_{lt})

Test Result

Test Parameter	Measurement Value	Limit	Remarks
P_{st}	0.160	1.0	Pass
P_{lt}	0.070	0.65	Pass
$T_{dt(s)}$	0.0	0.5	Pass
$d_{max}(\%)$	0.00%	4%	Pass
$d_c(\%)$	0.00%	3.3%	Pass

Any report having not been signed by authorized approver, or having been altered without authorization, or having not been stamped by the "Dedicated Testing/Inspection Stamp" is deemed to be invalid. Copying or excerpting portion of, or altering the content of the report is not permitted without the written authorization of AGC. The test results presented in the report apply only to the tested sample. Any objections to report issued by AGC should be submitted to AGC within 15 days after the issuance of the test report. Further enquiry of validity or verification of the test report should be addressed to AGC by agc@agc-cert.com.



11. IMMUNITY TEST

11.1. EUT SETUP AND OPERATING CONDITIONS

Each immunity test was performed according to the requirements of the standard.

11.2. GENERAL PERFORMANCE CRITERIA

1. Performance criteria for Continuous phenomena applied to Transmitter (CT)

The performance criteria A shall apply.

Tests shall be repeated with the EUT in standby mode (if applicable) to ensure that unintentional transmission does not occur. In systems using acknowledgement signals, it is recognized that an ACKnowledgement (ACK) or Not ACKnowledgement (NACK) transmission may occur, and steps should be taken to ensure that any transmission resulting from the application of the test is correctly interpreted.

2. Performance criteria for Transient phenomena applied to Transmitter (TT)

The performance criteria B shall apply, except for voltage dips of 100 ms and voltage interruptions of 5 000 ms duration, for which performance criteria C shall apply.

Tests shall be repeated with the EUT in standby mode (if applicable) to ensure that unintentional transmission does not occur. In systems using acknowledgement signals, it is recognized that an acknowledgement (ACK) or not-acknowledgement (NACK) transmission may occur, and steps should be taken to ensure that any transmission resulting from the application of the test is correctly interpreted.

3. Performance criteria for Continuous phenomena applied to Receiver (CR)

The performance criteria A shall apply.

Where the EUT is a transceiver, under no circumstances, shall the transmitter operate unintentionally during the test. In systems using acknowledgement signals, it is recognized that an ACK or NACK transmission may occur, and steps should be taken to ensure that any transmission resulting from the application of the test is correctly interpreted.

4. Performance criteria for Transient phenomena applied to Receiver (TR)

The performance criteria B shall apply, except for voltage dips of 100 ms and voltage interruptions of 5 000 ms duration for which performance criteria C shall apply.

Where the EUT is a transceiver, under no circumstances, shall the transmitter operate unintentionally during the test. In systems using acknowledgement signals, it is recognized that an ACK or NACK transmission may occur, and steps should be taken to ensure that any transmission resulting from the application of the test is correctly interpreted.

Any report having not been signed by authorized approver, or having been altered without authorization, or having not been stamped by the "Dedicated Testing/Inspection Stamp" is deemed to be invalid. Copying or excerpting portion of, or altering the content of the report is not permitted without the written authorization of AGC. The test results presented in the report apply only to the tested sample. Any objections to report issued by AGC should be submitted to AGC within 15 days after the issuance of the test report. Further enquiry of validity or verification of the test report should be addressed to AGC by agc@agc-cert.com.



5. Performance Table

EN 301 489-17 Performance criteria		
Criteria	During Test	After Test (i.e. as a result of the application of the test)
A	Shall operate as intended. (see note). Shall be no loss of function. Shall be no unintentional transmissions.	Shall operate as intended. Shall be no degradation of performance. Shall be no loss of function. Shall be no loss of critical stored data.
B	May be loss of function.	Functions shall be self-recoverable. Shall operate as intended after recovering. Shall be no loss of critical stored data.
C	May be loss of function.	Functions shall be recoverable by the operator. Shall operate as intended after recovering. Shall be no loss of critical stored data.
Note: Operate as intended during the test allows a level of degradation in accordance with the Minimum performance level.		
Minimum performance level		
For equipment that supports a PER or FER, the minimum performance level shall be a PER or FER less than or equal to 10 %.		
For equipment that does not support a PER or a FER, the minimum performance level shall be no loss of the wireless transmission function needed for the intended use of the equipment.		

Any report having not been signed by authorized approver, or having been altered without authorization, or having not been stamped by the "Dedicated Testing/Inspection Stamp" is deemed to be invalid. Copying or excerpting portion of, or altering the content of the report is not permitted without the written authorization of AGC. The test results presented in the report apply only to the tested sample. Any objections to report issued by AGC should be submitted to AGC within 15 days after the issuance of the test report. Further enquiry of validity or verification of the test report should be addressed to AGC by agc@agc-cert.com.



12. ELECTROSTATIC DISCHARGE IMMUNITY TEST

12.1 TEST SPECIFICATION

Basic Standard	EN 61000-4-2
Discharge Impedance	330Ω / 150 pF
Discharge Voltage	Air Discharge –8 kV, Contact Discharge – 4 kV
Polarity	Positive / Negative
Number of Discharge	Minimum 20 times at each test point
Discharge Mode	Single discharge
Discharge Period	1-second minimum

12.2 TEST PROCEDURE

The test procedure was in accordance with EN 61000-4-2:

- Electrostatic discharges were applied only to those points and surfaces of the EUT that are accessible to users during normal operation.
- The test was performed with at least ten single discharges on the pre-selected points in the most sensitive polarity.
- The time interval between two successive single discharges was at least 1 second.
- The ESD generator was held perpendicularly to the surface to which the discharge was applied and the return cable was at least 0.2 meters from the EUT.
- Contact discharges were applied to the non-insulating coating, with the pointed tip of the generator penetrating the coating and contacting the conducting substrate.
- Air discharges were applied with the round discharge tip of the discharge electrode approaching the EUT as fast as possible (without causing mechanical damage) to touch the EUT. After each discharge, the ESD generator was removed from the EUT and re-triggered for a new single discharge. The test was repeated until all discharges were completed.
- At least ten single discharges (in the most sensitive polarity) were applied to the Horizontal Coupling Plane at points on each side of the EUT. The ESD generator was positioned vertically at a distance of 0.1 meters from the EUT with the discharge electrode touching the HCP.
- At least ten single discharges (in the most sensitive polarity) were applied to the center of one vertical edge of the Vertical Coupling Plane in sufficiently different positions that the four faces of the EUT were completely illuminated. The VCP (dimensions 0.5m x 0.5m) was placed vertically to and 0.1 meters from the EUT.

Any report having not been signed by authorized approver, or having been altered without authorization, or having not been stamped by the "Dedicated Testing/Inspection Stamp" is deemed to be invalid. Copying or excerpting portion of, or altering the content of the report is not permitted without the written authorization of AGC. The test results presented in the report apply only to the tested sample. Any objections to report issued by AGC should be submitted to AGC within 15 days after the issuance of the test report. Further enquiry of validity or verification of the test report should be addressed to AGC by agc@agc-cert.com.



12.3 TEST SETUP

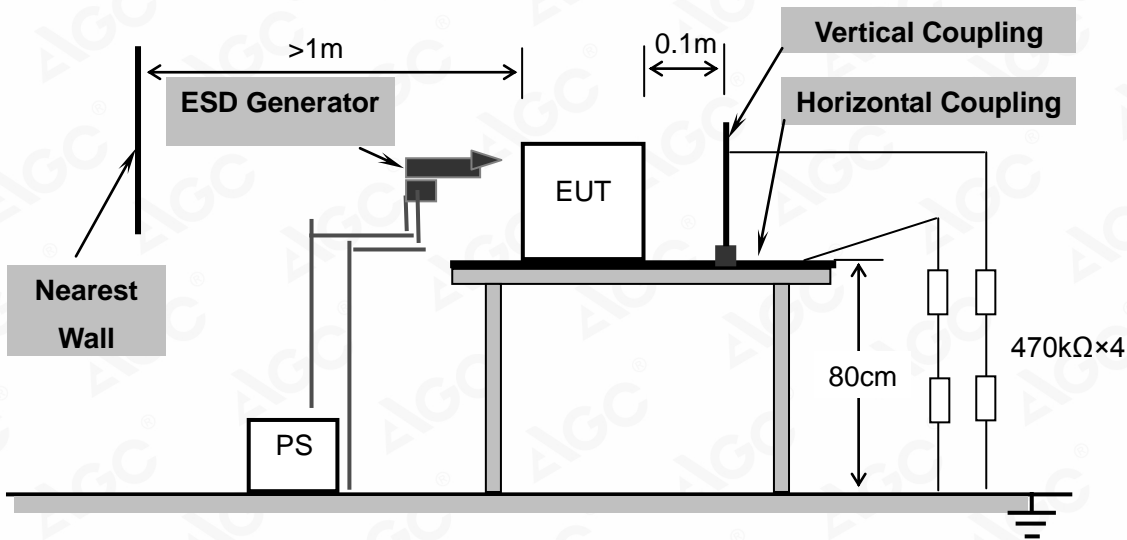

For the actual test configuration, please refer to Appendix A: Photographs of the Test Configuration.

12.4 TEST RESULT

DESCRIPTION OF THE ELECTROSTATIC DISCHARGES (ESD)

Amount of Discharges	Voltage	Coupling	Observation	Performance	Result (Pass/Fail)
Mini 20 / Point	±2KV, ±4kV	No Contact Discharge	No Function Loss	A	Pass
Mini 20 / Point	±2KV, ±4kV, ±8kV	Air Discharge	No Function Loss	A	Pass
Mini 20 / Point	±2KV, ±4kV	Indirect Discharge HCP	No Function Loss	A	Pass
Mini 20 / Point	±2KV, ±4kV	Indirect Discharge VCP	No Function Loss	A	Pass

Note: operating mode include all modes of EMS in page 10.

Any report having not been signed by authorized approver, or having been altered without authorization, or having not been stamped by the "Dedicated Testing/Inspection Stamp" is deemed to be invalid. Copying or excerpting portion of, or altering the content of the report is not permitted without the written authorization of AGC. The test results presented in the report apply only to the tested sample. Any objections to report issued by AGC should be submitted to AGC within 15days after the issuance of the test report. Further enquiry of validity or verification of the test report should be addressed to AGC by agc@agc-cert.com.



ESD location:

Yellow line: Air discharge

Red line: Contact discharge

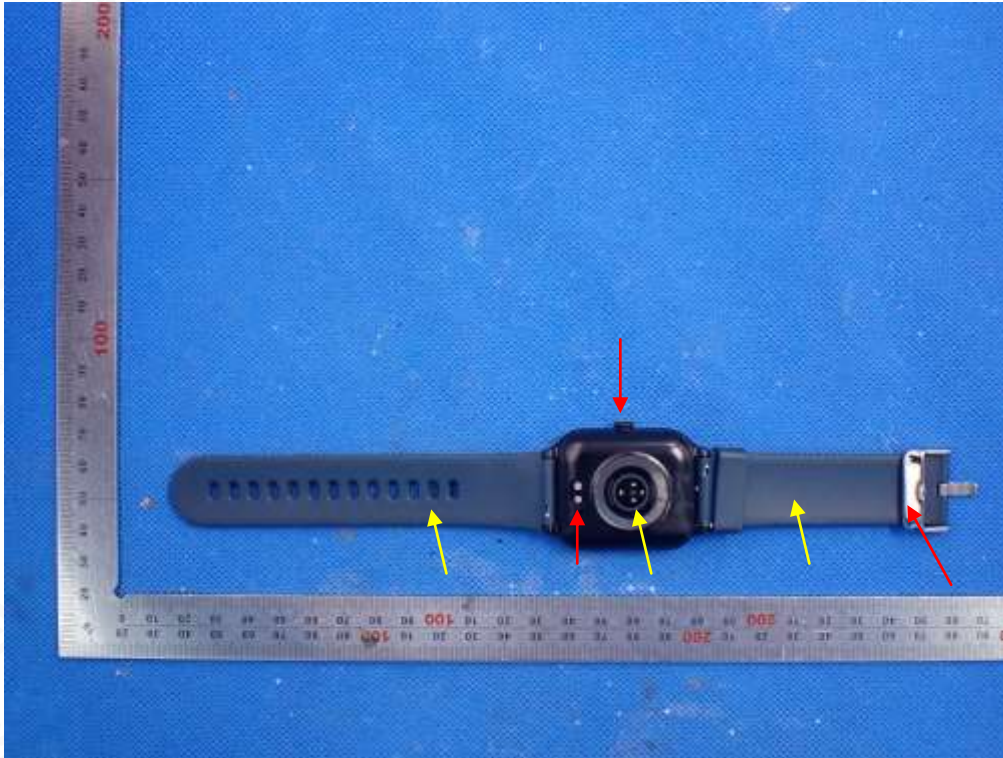

Any report having not been signed by authorized approver, or having been altered without authorization, or having not been stamped by the "Dedicated Testing/Inspection Stamp" is deemed to be invalid. Copying or excerpting portion of, or altering the content of the report is not permitted without the written authorization of AGC. The test results presented in the report apply only to the tested sample. Any objections to report issued by AGC should be submitted to AGC within 15 days after the issuance of the test report. Further enquiry of validity or verification of the test report should be addressed to AGC by agc@agc-cert.com.

Attestation of Global Compliance(Shenzhen)Co., Ltd

Attestation of Global Compliance(Shenzhen)Std & Tech Co., Ltd

Tel: +86-755 2523 4088 E-mail: agc@agc-cert.com Web: <http://cn.agc-cert.com/>



12.5 PERFORMANCE

<input checked="" type="checkbox"/> Criteria A:	The apparatus continues to operate as intended. No degradation of performance or loss of function is allowed below a performance level specified by the manufacturer, when the apparatus is used as intended. In some cases the performance level may be replaced by a permissible loss of performance.
<input type="checkbox"/> Criteria B:	The apparatus continues to operate as intended after the test. No degradation of performance or loss of function is allowed below a performance level specified by the manufacturer, when the apparatus is used as intended. In some cases the performance level may be replaced by a permissible loss of performance. During the test, degradation of performance is however allowed.
<input type="checkbox"/> Criteria C:	Temporary loss of function is allowed, provided the functions self recoverable or can be restored by the operation of controls.

PASS **FAIL**

Any report having not been signed by authorized approver, or having been altered without authorization, or having not been stamped by the "Dedicated Testing/Inspection Stamp" is deemed to be invalid. Copying or excerpting portion of, or altering the content of the report is not permitted without the written authorization of AGC. The test results presented in the report apply only to the tested sample. Any objections to report issued by AGC should be submitted to AGC within 15 days after the issuance of the test report. Further enquiry of validity or verification of the test report should be addressed to AGC by agc@agc-cert.com.



13. RADIATED, RADIO FREQUENCY ELECTROMAGNETIC FIELD IMMUNITY TEST

13.1. TEST SPECIFICATION

Basic Standard	EN 61000-4-3
Frequency Range	80 MHz – 6000MHz
Field Strength	3V/m
Modulation	1 kHz sine wave, 80%, AM modulation
Frequency Step	1% of fundamental
Polarity of Antenna	Horizontal and Vertical
Test Distance	3m
Antenna Height	1.55m
Dwell Time	3 seconds

13.2. TEST PROCEDURE

The test procedure was in accordance with EN 61000-4-3.

- a. The testing was performed in a fully anechoic chamber. The transmit antenna was located at a distance of 3 meters from the EUT.
- b. The test signal was 80% amplitude modulated with a 1 kHz sine wave.
- c. The frequency range was swept from 80 MHz to 6000MHz with the exception of the exclusion band for transmitters, receivers and duplex transceivers. The rate of sweep did not exceed 1.5×10^{-3} decade/s. Where the frequency range is swept incrementally, the step size was 1% of fundamental.
- d. The dwell time at each frequency shall be not less than the time necessary for the EUT to be able to respond.
- e. The field strength level was 3V/m.
- f. The test was performed with the EUT exposed to both vertically and horizontally polarized fields on each of the four sides.

Any report having not been signed by authorized approver, or having been altered without authorization, or having not been stamped by the "Dedicated Testing/Inspection Stamp" is deemed to be invalid. Copying or excerpting portion of, or altering the content of the report is not permitted without the written authorization of AGC. The test results presented in the report apply only to the tested sample. Any objections to report issued by AGC should be submitted to AGC within 15 days after the issuance of the test report. Further enquiry of validity or verification of the test report should be addressed to AGC by agc@agc-cert.com.



13.3. TEST SETUP

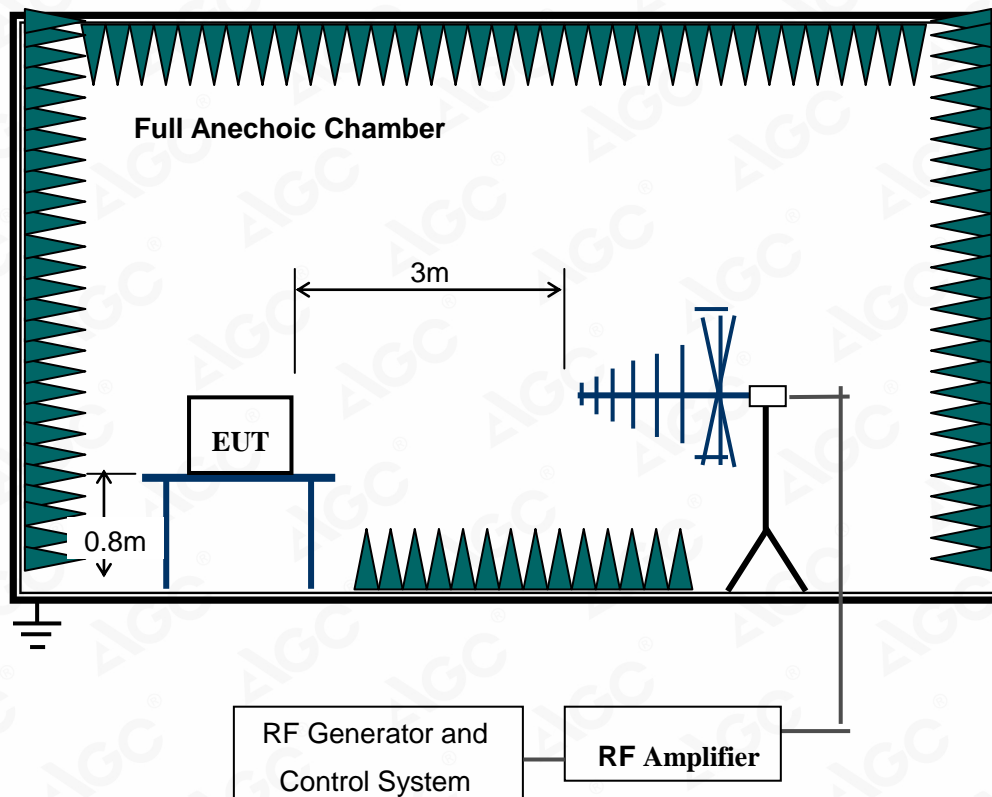

For the actual test configuration, please refer to Appendix A: Photographs of the Test Configuration.

Any report having not been signed by authorized approver, or having been altered without authorization, or having not been stamped by the "Dedicated Testing/Inspection Stamp" is deemed to be invalid. Copying or excerpting portion of, or altering the content of the report is not permitted without the written authorization of AGC. The test results presented in the report apply only to the tested sample. Any objections to report issued by AGC should be submitted to AGC within 15 days after the issuance of the test report. Further enquiry of validity or verification of the test report should be addressed to AGC by agc@agc-cert.com.



13.4. TEST RESULT

Freq. Range (MHz)	Field	Modulation	Polarity	Position	Observation	performance	Result (Pass/Fail)
80-6000	3V/m	Yes	H / V	Front	No Function Loss	A	PASS
80-6000	3V/m	Yes	H / V	Back	No Function Loss	A	PASS
80-6000	3V/m	Yes	H / V	Left	No Function Loss	A	PASS
80-6000	3V/m	Yes	H / V	Right	No Function Loss	A	PASS
80-6000	3V/m	Yes	H / V	Top	No Function Loss	A	PASS
80-6000	3V/m	Yes	H / V	Bottom	No Function Loss	A	PASS

Note: operating mode include all modes of EMS in page 10.

13.5. PERFORMANCE

<input checked="" type="checkbox"/> Criteria A:	The apparatus continues to operate as intended. No degradation of performance or loss of function is allowed below a performance level specified by the manufacturer, when the apparatus is used as intended. In some cases the performance level may be replaced by a permissible loss of performance.
<input type="checkbox"/> Criteria B:	The apparatus continues to operate as intended after the test. No degradation of performance or loss of function is allowed below a performance level specified by the manufacturer, when the apparatus is used as intended. In some cases the performance level may be replaced by a permissible loss of performance. During the test, degradation of performance is however allowed.
<input type="checkbox"/> Criteria C:	Temporary loss of function is allowed, provided the functions self recoverable or can be restored by the operation of controls.

PASS

FAIL

Any report having not been signed by authorized approver, or having been altered without authorization, or having not been stamped by the "Dedicated Testing/Inspection Stamp" is deemed to be invalid. Copying or excerpting portion of, or altering the content of the report is not permitted without the written authorization of AGC. The test results presented in the report apply only to the tested sample. Any objections to report issued by AGC should be submitted to AGC within 15 days after the issuance of the test report. Further enquiry of validity or verification of the test report should be addressed to AGC by agc@agc-cert.com.

Attestation of Global Compliance(Shenzhen)Co., Ltd
Attestation of Global Compliance(Shenzhen)Std & Tech Co., Ltd
Tel: +86-755 2523 4088 E-mail: agc@agc-cert.com Web: http://cn.agc-cert.com/



14. ELECTRICAL FAST TRANSIENT/BURST IMMUNITY TEST

14.1. TEST SPECIFICATION

Basic Standard	EN 61000-4-4
Test Voltage	a.c. power port – 1 kV
Polarity	Positive/Negative
Impulse Frequency	5kHz
Impulse wave shape	5/50ns
Burst Duration	15ms
Burst Period	300ms
Test Duration	Not less than 1 min.

14.2. TEST PROCEDURE

1. The EUT was tested with 1000 volt discharges to the AC power input leads.
2. Both positive and negative polarity discharges were applied.
3. The length of the “hot wire” from the coaxial output of the EFT generator to the terminals on the EUT should not exceed 1 meter.
4. The duration time of each test sequential was 1 minute.
5. The transient/burst waveform was in accordance with IEC 61000-4-4, 5/50ns.

14.3. TEST SETUP

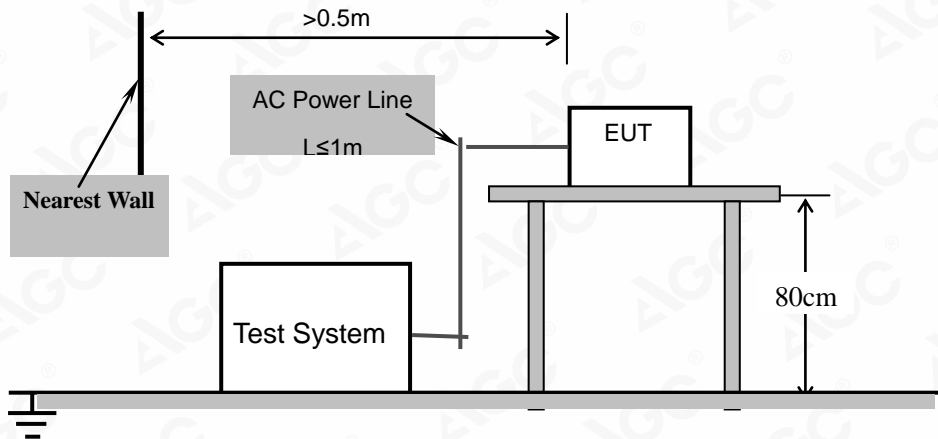

For the actual test configuration, please refer to Appendix A: Photographs of the Test Configuration.

Any report having not been signed by authorized approver, or having been altered without authorization, or having not been stamped by the "Dedicated Testing/Inspection Stamp" is deemed to be invalid. Copying or excerpting portion of, or altering the content of the report is not permitted without the written authorization of AGC. The test results presented in the report apply only to the tested sample. Any objections to report issued by AGC should be submitted to AGC within 15 days after the issuance of the test report. Further enquiry of validity or verification of the test report should be addressed to AGC by agc@agc-cert.com.

Attestation of Global Compliance(Shenzhen)Co., Ltd
Attestation of Global Compliance(Shenzhen)Std & Tech Co., Ltd
Tel: +86-755 2523 4088 E-mail: agc@agc-cert.com Web: <http://cn.agc-cert.com/>



14.4. TEST RESULT

Test Point	Polarity	Test Level (kV)	Observation	performance	Conclusion
a.c. port, L	+/-	1	No function loss	A	Pass
a.c. port, N	+/-	1	No function loss	A	Pass
a.c. port, L-N	+/-	1	No function loss	A	Pass

Note: operating mode include all modes of EMS in page 10.

14.5. PERFORMANCE

<input checked="" type="checkbox"/> Criteria A:	The apparatus continues to operate as intended. No degradation of performance or loss of function is allowed below a performance level specified by the manufacturer, when the apparatus is used as intended. In some cases the performance level may be replaced by a permissible loss of performance.
<input type="checkbox"/> Criteria B:	The apparatus continues to operate as intended after the test. No degradation of performance or loss of function is allowed below a performance level specified by the manufacturer, when the apparatus is used as intended. In some cases the performance level may be replaced by a permissible loss of performance. During the test, degradation of performance is however allowed.
<input type="checkbox"/> Criteria C:	Temporary loss of function is allowed, provided the functions self recoverable or can be restored by the operation of controls.

PASS

FAIL

Any report having not been signed by authorized approver, or having been altered without authorization, or having not been stamped by the "Dedicated Testing/Inspection Stamp" is deemed to be invalid. Copying or excerpting portion of, or altering the content of the report is not permitted without the written authorization of AGC. The test results presented in the report apply only to the tested sample. Any objections to report issued by AGC should be submitted to AGC within 15 days after the issuance of the test report. Further enquiry of validity or verification of the test report should be addressed to AGC by agc@agc-cert.com.



15. SURGE IMMUNITY TEST

15.1. TEST SPECIFICATION

Basic Standard	EN 61000-4-5
Waveform	Voltage 1.2/50 μ s; Current 8/20 μ s
Test Voltage	a.c. power port, line to line 1.0 kV
Polarity	Positive/Negative
Phase Angle	0°, 90°, 180°, 270°
Repetition Rate	60sec
Times	5 time/each condition.

15.2. TEST PROCEDURE

- The EUT and the auxiliary equipment were placed on a table of 0.8m heights above a metal ground reference plane. The size of ground plane is greater than 1m \times 1m and project beyond the EUT by at least 0.1m on all sides. The ground plane is connected to the protective earth. The length of power cord between the coupling device and the EUT was less than 2 meters (provided by the manufacturer).
- The EUT was connected to the power mains through a coupling device that directly couples the surge interference signal. The surge noise was applied synchronized to the voltage phase at the zero crossing and the peak value of the AC voltage wave (positive and negative).
- The surges were applied line to line and line(s) to earth. All lower levels including the selected test level were tested. The polarity of each surge level included positive and negative test pulses.

15.3. TEST SETUP

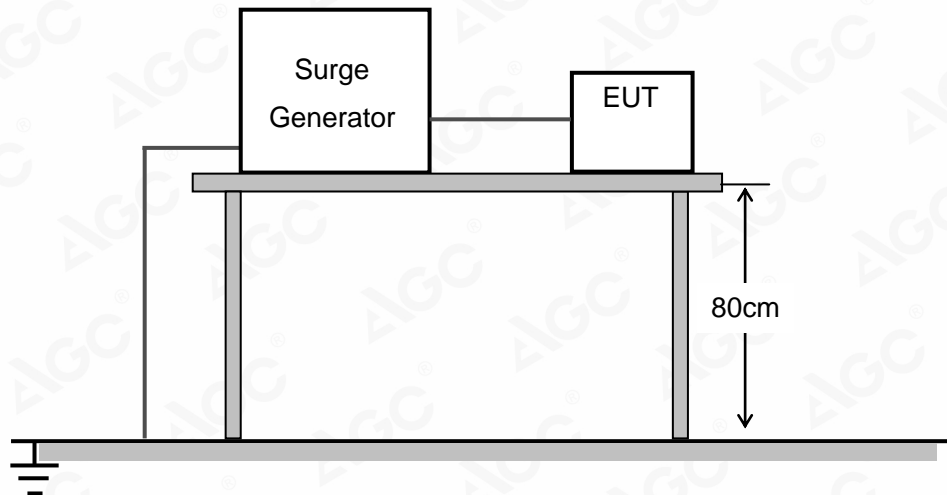

For the actual test configuration, please refer to Appendix A: Photographs of the Test Configuration.

Any report having not been signed by authorized approver, or having been altered without authorization, or having not been stamped by the "Dedicated Testing/Inspection Stamp" is deemed to be invalid. Copying or excerpting portion of, or altering the content of the report is not permitted without the written authorization of AGC. The test results presented in the report apply only to the tested sample. Any objections to report issued by AGC should be submitted to AGC within 15 days after the issuance of the test report. Further enquiry of validity or verification of the test report should be addressed to AGC by agc@agc-cert.com.

Attestation of Global Compliance(Shenzhen)Co., Ltd
Attestation of Global Compliance(Shenzhen)Std & Tech Co., Ltd
Tel: +86-755 2523 4088 E-mail: agc@agc-cert.com Web: http://cn.agc-cert.com/



15.4. TEST RESULT

Coupling Line	Polarity	Voltage (kV)	Observation	performance	Conclusion
a.c. power, L-N	+/-	1.0	No function loss	A	Pass

Note: operating mode include all modes of EMS in page 10.

15.5. PERFORMANCE

<input checked="" type="checkbox"/> Criteria A:	The apparatus continues to operate as intended. No degradation of performance or loss of function is allowed below a performance level specified by the manufacturer, when the apparatus is used as intended. In some cases the performance level may be replaced by a permissible loss of performance.
<input type="checkbox"/> Criteria B:	The apparatus continues to operate as intended after the test. No degradation of performance or loss of function is allowed below a performance level specified by the manufacturer, when the apparatus is used as intended. In some cases the performance level may be replaced by a permissible loss of performance. During the test, degradation of performance is however allowed.
<input type="checkbox"/> Criteria C:	Temporary loss of function is allowed, provided the functions self recoverable or can be restored by the operation of controls.

PASS

 FAIL

Any report having not been signed by authorized approver, or having been altered without authorization, or having not been stamped by the "Dedicated Testing/Inspection Stamp" is deemed to be invalid. Copying or excerpting portion of, or altering the content of the report is not permitted without the written authorization of AGC. The test results presented in the report apply only to the tested sample. Any objections to report issued by AGC should be submitted to AGC within 15days after the issuance of the test report. Further enquiry of validity or verification of the test report should be addressed to AGC by agc@agc-cert.com.

Attestation of Global Compliance(Shenzhen)Co., Ltd
 Attestation of Global Compliance(Shenzhen)Std & Tech Co., Ltd
 Tel: +86-755 2523 4088 E-mail: agc@agc-cert.com Web: http://cn.agc-cert.com/



16. IMMUNITY TO CONDUCTED DISTURBANCES INDUCED BY RF FIELDS

16.1. TEST SPECIFICATION

Basic Standard	EN 61000-4-6
Frequency Range	0.15 MHz – 80 MHz
Field Strength	3Vrms
Modulation	1 kHz Sine Wave, 80% AM
Frequency Step	1% of fundamental
Coupled Cable	a.c. power line
Coupling Device	CDN-M2

16.2. TEST PROCEDURE

1. The EUT shall be tested within its intended operating and climatic conditions.
2. The test shall be performed with the test generator connected to each of the coupling and decoupling devices in turn, while the other non-excited RF input ports of the coupling devices are terminated by a 50-ohm load resistor.
3. The test signal was 80% amplitude modulated with a 1 kHz sine wave
4. The frequency range is swept from 150 kHz to 80 MHz, using the signal level established during the setting process and with a disturbance signal of 80% amplitude. The sweep rate shall not exceed 1.5×10^{-3} decades/s. The step size shall not exceed 1% of the start and thereafter 1% of the preceding frequency value where the frequency is swept incrementally.
5. The dwell time at each frequency shall not be less than the time necessary for the EUT to be exercised, and able to respond. Sensitive frequencies such as clock frequencies and harmonics or frequencies of dominant interest, shall be analyzed separately.
6. Attempts should be made to fully exercise the EUT during test, and to fully interrogate all exercise modes selected for susceptibility.

16.3. TEST SETUP

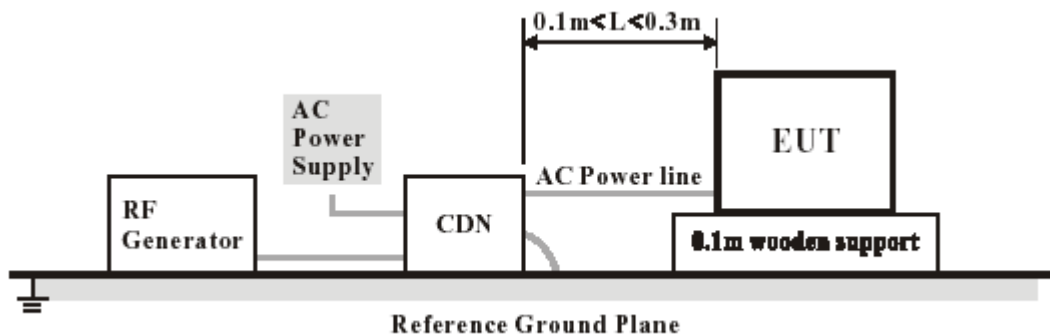

For the actual test configuration, please refer to Appendix A: Photographs of the Test Configuration.

Any report having not been signed by authorized approver, or having been altered without authorization, or having not been stamped by the "Dedicated Testing/Inspection Stamp" is deemed to be invalid. Copying or excerpting portion of, or altering the content of the report is not permitted without the written authorization of AGC. The test results presented in the report apply only to the tested sample. Any objections to report issued by AGC should be submitted to AGC within 15 days after the issuance of the test report. Further enquiry of validity or verification of the test report should be addressed to AGC by agc@agc-cert.com.

Attestation of Global Compliance(Shenzhen)Co., Ltd
Attestation of Global Compliance(Shenzhen)Std & Tech Co., Ltd
Tel: +86-755 2523 4088 E-mail: agc@agc-cert.com Web: http://cn.agc-cert.com/



16.4. TEST RESULT

EUT Working Mode	Test Point	Frequency (MHz)	Field Strength (Vrms)	Observation	performance	Conclusion
Normal	a.c. port	0.15 – 80	3	No function loss	A	Pass

Note: operating mode include all modes of EMS in page 10.

16.5. PERFORMANCE

<input checked="" type="checkbox"/> Criteria A:	The apparatus continues to operate as intended. No degradation of performance or loss of function is allowed below a performance level specified by the manufacturer, when the apparatus is used as intended. In some cases the performance level may be replaced by a permissible loss of performance.
<input type="checkbox"/> Criteria B:	The apparatus continues to operate as intended after the test. No degradation of performance or loss of function is allowed below a performance level specified by the manufacturer, when the apparatus is used as intended. In some cases the performance level may be replaced by a permissible loss of performance. During the test, degradation of performance is however allowed.
<input type="checkbox"/> Criteria C:	Temporary loss of function is allowed, provided the functions self recoverable or can be restored by the operation of controls.

PASS

 FAIL

Any report having not been signed by authorized approver, or having been altered without authorization, or having not been stamped by the "Dedicated Testing/Inspection Stamp" is deemed to be invalid. Copying or excerpting portion of, or altering the content of the report is not permitted without the written authorization of AGC. The test results presented in the report apply only to the tested sample. Any objections to report issued by AGC should be submitted to AGC within 15days after the issuance of the test report. Further enquiry of validity or verification of the test report should be addressed to AGC by agc@agc-cert.com.

Attestation of Global Compliance(Shenzhen)Co., Ltd
 Attestation of Global Compliance(Shenzhen)Std & Tech Co., Ltd
 Tel: +86-755 2523 4088 E-mail: agc@agc-cert.com Web: http://cn.agc-cert.com/



17. VOLTAGE DIPS AND SHORT INTERRUPTIONS IMMUNITY TEST

17.1. TEST SPECIFICATION

Basic Standard	EN 61000-4-11
Voltage Dips	100% reduction, 0.5 Cycle 100% reduction, 1.0 Cycle 30% reduction, 25 Cycles
Voltage Interruptions	100% reduction, 250 Cycles
Voltage Phase Angle	0°, 45°, 90°, 135°, 180°, 225°, 270°, 315°

17.2. TEST PROCEDURE

- The power cord was used as supplied by the manufacturer. The EUT was connected to the line output of the Voltage Dips and Interruption Generator.
- The EUT was tested for (1) 100% voltage dip of supplied voltage with duration of 0.5 cycles, (2) 100% voltage dip of supplied voltage and duration 1.0 cycle. (3) 30% voltage dip of supplied voltage and duration 25 cycles. (4) 100% voltage interruption of supplied voltage with duration of 250 Cycles was followed.
- Voltage reductions occur at 0 degree crossover point of the voltage waveform. The performance of the EUT was checked after the voltage dip or interruption.

17.3. TEST SETUP

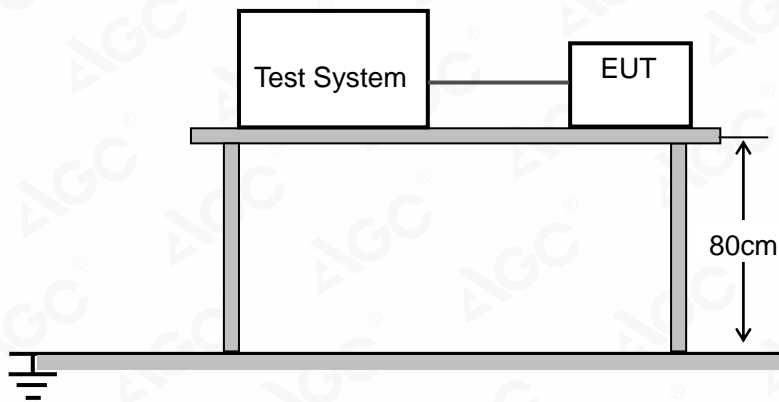

For the actual test configuration, please refer to Appendix A, Photographs of the Test Configuration.

Any report having not been signed by authorized approver, or having been altered without authorization, or having not been stamped by the "Dedicated Testing/Inspection Stamp" is deemed to be invalid. Copying or excerpting portion of, or altering the content of the report is not permitted without the written authorization of AGC. The test results presented in the report apply only to the tested sample. Any objections to report issued by AGC should be submitted to AGC within 15 days after the issuance of the test report. Further enquiry of validity or verification of the test report should be addressed to AGC by agc@agc-cert.com.

Attestation of Global Compliance(Shenzhen)Co., Ltd
Attestation of Global Compliance(Shenzhen)Std & Tech Co., Ltd
Tel: +86-755 2523 4088 E-mail: agc@agc-cert.com Web: http://cn.agc-cert.com/



17.4. TEST RESULT

Test Mode	Voltage Reduction	Duration (cycle)	Times	Interval (ms)	Observation	performance	Conclusion
Voltage dips	100%	0.5	3	10	No function loss	B	Pass
	100%	1	3	20	No function loss	C	Pass
	30%	25	3	500	No function loss	C	Pass
Voltage interruptions	100%	250	3	5000	No function loss	C	Pass

Note: operating mode include all modes of EMS in page 10.

17.5. PERFORMANCE

<input type="checkbox"/> Criteria A:	The apparatus continues to operate as intended. No degradation of performance or loss of function is allowed below a performance level specified by the manufacturer, when the apparatus is used as intended. In some cases the performance level may be replaced by a permissible loss of performance.
<input checked="" type="checkbox"/> Criteria B:	The apparatus continues to operate as intended after the test. No degradation of performance or loss of function is allowed below a performance level specified by the manufacturer, when the apparatus is used as intended. In some cases the performance level may be replaced by a permissible loss of performance. During the test, degradation of performance is however allowed.
<input checked="" type="checkbox"/> Criteria C:	Temporary loss of function is allowed, provided the functions self recoverable or can be restored by the operation of controls.

PASS **FAIL**

Any report having not been signed by authorized approver, or having been altered without authorization, or having not been stamped by the "Dedicated Testing/Inspection Stamp" is deemed to be invalid. Copying or excerpting portion of, or altering the content of the report is not permitted without the written authorization of AGC. The test results presented in the report apply only to the tested sample. Any objections to report issued by AGC should be submitted to AGC within 15days after the issuance of the test report. Further enquiry of validity or verification of the test report should be addressed to AGC by agc@agc-cert.com.

Attestation of Global Compliance(Shenzhen)Co., Ltd
Attestation of Global Compliance(Shenzhen)Std & Tech Co., Ltd
Tel: +86-755 2523 4088 E-mail: agc@agc-cert.com Web: http://cn.agc-cert.com/



APPENDIX A: PHOTOGRAPHS OF TEST SETUP

Refer to Attached file (Appendix I)

APPENDIX B: PHOTOGRAPHS OF EUT

Refer to Attached file (Appendix I)

----END OF REPORT----

Any report having not been signed by authorized approver, or having been altered without authorization, or having not been stamped by the "Dedicated Testing/Inspection Stamp" is deemed to be invalid. Copying or excerpting portion of, or altering the content of the report is not permitted without the written authorization of AGC. The test results presented in the report apply only to the tested sample. Any objections to report issued by AGC should be submitted to AGC within 15days after the issuance of the test report. Further enquiry of validity or verification of the test report should be addressed to AGC by agc@agc-cert.com.

Attestation of Global Compliance(Shenzhen)Co., Ltd

Attestation of Global Compliance(Shenzhen)Std & Tech Co., Ltd

Tel: +86-755 2523 4088 E-mail: agc@agc-cert.com Web: <http://cn.agc-cert.com/>



Conditions of Issuance of Test Reports

1. All samples and goods are accepted by the Attestation of Global Compliance (Shenzhen) Co., Ltd (the “Company”) solely for testing and reporting in accordance with the following terms and conditions. The company provides its services on the basis that such terms and conditions constitute express agreement between the company and any person, firm or company requesting its services (the “Clients”).
2. Any report issued by Company as a result of this application for testing services (the “Report”) shall be issued in confidence to the Clients and the Report will be strictly treated as such by the Company. It may not be reproduced either in its entirety or in part and it may not be used for advertising or other unauthorized purposes without the written consent of the Company. The Clients to whom the Report is issued may, however, show or send it, or a certified copy thereof prepared by the Company to its customer, supplier or other persons directly concerned. The Company will not, without the consent of the Clients, enter into any discussion or correspondence with any third party concerning the contents of the Report, unless required by the relevant governmental authorities, laws or court orders.
3. The Company shall not be called or be liable to be called to give evidence or testimony on the Report in a court of law without its prior written consent, unless required by the relevant governmental authorities, laws or court orders.
4. The non-CMA report issued by AGC is only permitted to be used by the client as internal reference use and shall not be used for public demonstration purpose.
5. In the event of the improper use of the report as determined by the Company, the Company reserves the right to withdraw it, and to adopt any other additional remedies which may be appropriate.
6. Samples submitted for testing are accepted on the understanding that the Report issued cannot form the basis of, or be the instrument for, any legal action against the Company.
7. The Company will not be liable for or accept responsibility for any loss or damage however arising from the use of information contained in any of its Reports or in any communication whatsoever about its said tests or investigations.
8. Clients wishing to use the Report in court proceedings or arbitration shall inform the Company to that effect prior to submitting the sample for testing.
9. The Company is not responsible for recalling the electronic version of the original report when any revision is made to them. The Client assumes the responsibility to providing the revised version to any interested party who uses them.
10. Subject to the variable length of retention time for test data and report stored hereinto as otherwise specifically required by individual accreditation authorities, the Company will only keep the supporting test data and information of the test report for a period of six years. The data and information will be disposed of after the aforementioned retention period has elapsed. Under no circumstances shall we provide any data and information which has been disposed of after retention period. Under no circumstances shall we be liable for damage of any kind, including (but not limited to) compensatory damages, lost profits, lost data, or any form of special, incidental, indirect, consequential or punitive damages of any kind, whether based on breach of contract of warranty, tort (including negligence), product liability or otherwise, even if we are informed in advance of the possibility of such damages.

Any report having not been signed by authorized approver, or having been altered without authorization, or having not been stamped by the “Dedicated Testing/Inspection Stamp” is deemed to be invalid. Copying or excerpting portion of, or altering the content of the report is not permitted without the written authorization of AGC. The test results presented in the report apply only to the tested sample. Any objections to report issued by AGC should be submitted to AGC within 15 days after the issuance of the test report. Further enquiry of validity or verification of the test report should be addressed to AGC by agc@agc-cert.com.

