Safety Test Report

Report No.: AGC03709200901ES01

PRODUCT DESIGNATION : smartwatch
BRAND NAME : N/A
MODEL NAME : R3 Pro, R1, R2, R3, R5, R6
APPLICANT : Shenzhen Xinhuaajtong Technology Co., Ltd.
DATE OF ISSUE : Sep. 27, 2020
STANDARD(S) : EN 62368-1:2014+A11:2017
REPORT VERSION: : V1.0



Attestation of Global Compliance(Shenzhen) Co., Ltd.



Any report having not been signed by authorized approver, or having been altered without authorization, or having not been stamped by the "Dedicated Testing/Inspection Stamp" is deemed to be invalid. Copying or excerpting portion of, or altering the content of the report is not permitted without the written authorization of AGC. The test results presented in the report apply only to the tested sample. Any objections to report issued by AGC should be submitted to AGC within 15days after the issuance of the test report. Further enquiry of validity or verification of the test report should be addressed to AGC by agc@agc-cert.com.

Attestation of Global Compliance(Shenzhen)Co., Ltd
Attestation of Global Compliance(Shenzhen)Std & Tech Co., Ltd
Tel: +86-755 2523 4088 E-mail: agc@agc-cert.com Web: <http://cn.agc-cert.com/>

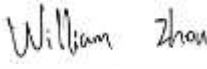

TEST REPORT EN 62368-1 Audio/video, information and communication technology equipment Part 1: Safety requirements	
Report No.	AGC03709200901ES01
Tested by (+ signature).....	William Zhou 
Reviewed by (+ signature)	Byron Wang 
Approved by (+ signature)	Matte He (Authorized Officer) 
Date of issue	Sep. 27, 2020
Contents.....	Total 59 pages
Testing laboratory	
Name.....	Attestation of Global Compliance (Shenzhen) Co., Ltd.
Address.....	1-2/F, Building 19, Junfeng Industrial Park, Chongqing Road, Heping Community, Fuhai Street, Bao 'an District, Shenzhen, Guangdong, China
Testing location.....	Same as above.
Applicant	
Name.....	Shenzhen Xinhuaaitong Technology Co., Ltd.
Address.....	802, Building 3, No. 7 Industrial Zone, Yulu Community, Yutang Street, Guangming District, Shenzhen
Manufacturer	
Name.....	Shenzhen Xinhuaaitong Technology Co., Ltd.
Address.....	802, Building 3, No. 7 Industrial Zone, Yulu Community, Yutang Street, Guangming District, Shenzhen
Factory	
Name.....	Shenzhen Xinhuaaitong Technology Co., Ltd.
Address.....	802, Building 3, No. 7 Industrial Zone, Yulu Community, Yutang Street, Guangming District, Shenzhen
Test specification	
Standard.....	EN 62368-1:2014+A11:2017
Test procedure	Type test
Procedure deviation.....	N/A
Non-standard test method.....	N/A

Any report having not been signed by authorized approver, or having been altered without authorization, or having not been stamped by the "Dedicated Testing/Inspection Stamp" is deemed to be invalid. Copying or excerpting portion of, or altering the content of the report is not permitted without the written authorization of AGC. The test results presented in the report apply only to the tested sample. Any objections to report issued by AGC should be submitted to AGC within 15days after the issuance of the test report. Further enquiry of validity or verification of the test report should be addressed to AGC by agc@agc-cert.com.



Test Report Form/blank test report	
Test Report Form No.....	AGC62368A2
TRF originator.....	AGC
Master TRF	2018-09
Test item	
Product designation	smartwatch
Brand name	N/A
Test model	R3 Pro
Series model	R1, R2, R3, R5, R6
Rating(s).....	5V $\overline{---}$, 0.5A
Test item particulars	
Classification of use by	<input checked="" type="checkbox"/> Ordinary person <input type="checkbox"/> Instructed person <input type="checkbox"/> Skilled person <input type="checkbox"/> Children likely to be present
Supply Connection.....	<input type="checkbox"/> AC Mains <input type="checkbox"/> DC Mains <input checked="" type="checkbox"/> External Circuit - not Mains connected - <input checked="" type="checkbox"/> ES1 <input type="checkbox"/> ES2 <input type="checkbox"/> ES3
Supply % Tolerance	<input type="checkbox"/> +10%/-10% <input type="checkbox"/> +20%/-15% <input type="checkbox"/> +____%/ -____% <input checked="" type="checkbox"/> None
Supply Connection – Type.....	<input type="checkbox"/> pluggable equipment type A - <input type="checkbox"/> non-detachable supply cord <input type="checkbox"/> appliance coupler <input type="checkbox"/> direct plug-in <input type="checkbox"/> mating connector <input type="checkbox"/> pluggable equipment type B - <input type="checkbox"/> non-detachable supply cord <input type="checkbox"/> appliance coupler <input type="checkbox"/> permanent connection <input type="checkbox"/> mating connector <input checked="" type="checkbox"/> other: <u>not mains connected</u>
Considered current rating of protective device as part of building or equipment installation	N/A Installation location: <input type="checkbox"/> building; <input type="checkbox"/> equipment
Equipment mobility.....	<input type="checkbox"/> movable <input type="checkbox"/> hand-held <input checked="" type="checkbox"/> transportable <input type="checkbox"/> stationary <input type="checkbox"/> for building-in <input type="checkbox"/> direct plug-in <input type="checkbox"/> rack-mounting <input type="checkbox"/> wall-mounted

Any report having not been signed by authorized approver, or having been altered without authorization, or having not been stamped by the "Dedicated Testing/Inspection Stamp" is deemed to be invalid. Copying or excerpting portion of, or altering the content of the report is not permitted without the written authorization of AGC. The test results presented in the report apply only to the tested sample. Any objections to report issued by AGC should be submitted to AGC within 15 days after the issuance of the test report. Further enquiry of validity or verification of the test report should be addressed to AGC by agc@agc-cert.com.



Over voltage category (OVC)	<input type="checkbox"/> OVC I <input type="checkbox"/> OVC II <input type="checkbox"/> OVC III <input type="checkbox"/> OVC IV <input checked="" type="checkbox"/> other: <u>not mains connected</u>
Class of equipment	<input type="checkbox"/> Class I <input type="checkbox"/> Class II <input checked="" type="checkbox"/> Class III
Access location	<input type="checkbox"/> restricted access location <input checked="" type="checkbox"/> N/A
Pollution degree (PD)	<input type="checkbox"/> PD 1 <input checked="" type="checkbox"/> PD 2 <input type="checkbox"/> PD 3
Manufacturer's specified maximum operating ambient.....	40°C
IP protection class	<input checked="" type="checkbox"/> IPX0 <input type="checkbox"/> IP
Power Systems	<input type="checkbox"/> TN <input type="checkbox"/> TT <input type="checkbox"/> IT - ____ V _{L-L}
Altitude during operation (m)	<input checked="" type="checkbox"/> 2000 m or less <input type="checkbox"/> ____ m
Altitude of test laboratory (m)	<input checked="" type="checkbox"/> 2000 m or less <input type="checkbox"/> ____ m
Mass of equipment (kg)	<input checked="" type="checkbox"/> <1 kg

Test case verdicts

Test case does not apply to the test object..... : N (/A)

Test item does meet the requirement

Test item does not meet the requirement

Testing

Date of receipt of test item..... : Sep. 04, 2020

Date of performance of test..... : Sep. 04 - Sep. 14, 2020

Attachments

Attachment A

General remarks

This report shall not be reproduced except in full without the written approval of the testing laboratory.

The test results presented in this report relate only to the item tested.

“(See remark #)” refers to a remark appended to the report.

“(See appended table)” refers to a table appended to the report.

Throughout this report a comma is used as the decimal separator.

Report Revise Record:				
Report Version	Revise Time	Issued Date	Valid Version	Notes
V1.0	/	Sep. 27, 2020	Valid	Initial release

General product information

The product supplied by Li-ion battery, and charge from approved Adapter via 2 magnetic pins connection. It is considered transportable and Class III.

All models are identical except model name, no impact safety. All tests were conducted with model R3 Pro to represent all models.

Instructions and equipment marking related to safety is applied in the language that is acceptable in the country in which the equipment is to be sold.

The product was submitted and tested for use at the manufacturer's recommended ambient temperature (T_{ma}) of 40°C.

Any report having not been signed by authorized approver, or having been altered without authorization, or having not been stamped by the "Dedicated Testing/Inspection Stamp" is deemed to be invalid. Copying or excerpting portion of, or altering the content of the report is not permitted without the written authorization of AGC. The test results presented in the report apply only to the tested sample. Any objections to report issued by AGC should be submitted to AGC within 15days after the issuance of the test report. Further enquiry of validity or verification of the test report should be addressed to AGC by agc@agc-cert.com.



Summary of testing

The test item passed.

Copy of marking plates



Remark:

- 1) The CE marking and WEEE symbol (if any) should be at least 5mm and 7mm respectively in height.
- 2) The markings and instructions are the minimum requirements required by safety standard. For final production samples, the additional markings which do not give rise to misunderstanding may be added.
- 3) As declared by the applicant, the importer (and manufacturer, if it is different)'s name, registered trade name or mark and the postal address will be marked on the products before being place on the market.
- 4) Marking on the packaging or in a document accompanying the electrical equipment is only acceptable if it is not possible to place such markings on the product.

Any report having not been signed by authorized approver, or having been altered without authorization, or having not been stamped by the "Dedicated Testing/Inspection Stamp" is deemed to be invalid. Copying or excerpting portion of, or altering the content of the report is not permitted without the written authorization of AGC. The test results presented in the report apply only to the tested sample. Any objections to report issued by AGC should be submitted to AGC within 15days after the issuance of the test report. Further enquiry of validity or verification of the test report should be addressed to AGC by agc@agc-cert.com.

Attestation of Global Compliance(Shenzhen)Co., Ltd
Attestation of Global Compliance(Shenzhen)Std & Tech Co., Ltd
Tel: +86-755 2523 4088 E-mail: agc@agc-cert.com Web: http://cn.agc-cert.com/



ENERGY SOURCE IDENTIFICATION AND CLASSIFICATION TABLE:	
(Note 1: Identify the following six (6) energy source forms based on the origin of the energy.) (Note 2: The identified classification e.g., ES2, TS1, should be with respect to its ability to cause pain or injury on the body or its ability to ignite a combustible material. Any energy source can be declared Class 3 as a worse case classification e.g. PS3, ES3.)	
Electrically-caused injury (Clause 5): (Note: Identify type of source, list sub-assembly or circuit designation and corresponding energy source classification) Example: +5 V dc input	
	ES1
Source of electrical energy	Corresponding classification (ES)
Internal circuitry	ES1
Electrically-caused fire (Clause 6): (Note: List sub-assembly or circuit designation and corresponding energy source classification) Example: Battery pack (maximum 85 watts):	
	PS2
Source of power or PIS	Corresponding classification (PS)
2 magnetic pin supply port	PS2
Internal circuitry	PS2
Battery cell output	PS1
Battery pack output	PS1
Injury caused by hazardous substances (Clause 7) (Note: Specify hazardous chemicals, whether produces ozone or other chemical construction not addressed as part of the component evaluation.) Example: Liquid in filled component	
	Glycol
Source of hazardous substances	Corresponding chemical
Li-ion battery	Complied with annex M
Mechanically-caused injury (Clause 8) (Note: List moving part(s), fan, special installations, etc. & corresponding MS classification based on Table 35.) Example: Wall mount unit	
	MS2
Source of kinetic/mechanical energy	Corresponding classification (MS)
Edges and corners	MS1
Equipment mass	MS1
Internal DC motor	MS1
Thermal burn injury (Clause 9) (Note: Identify the surface or support, and corresponding energy source classification based on type of part, location, operating temperature and contact time in Table 38.) Example: Hand-held scanner – thermoplastic enclosure	
	TS1
Source of thermal energy	Corresponding classification (TS)
All accessible parts	TS1
Radiation (Clause 10) (Note: List the types of radiation present in the product and the corresponding energy source classification.) Example: DVD – Class 1 Laser Product	
	RS1
Type of radiation	Corresponding classification (RS)
Indicator LED	RS1

Any report having not been signed by authorized approver, or having been altered without authorization, or having not been stamped by the "Dedicated Testing/Inspection Stamp" is deemed to be invalid. Copying or excerpting portion of, or altering the content of the report is not permitted without the written authorization of AGC. The test results presented in the report apply only to the tested sample. Any objections to report issued by AGC should be submitted to AGC within 15 days after the issuance of the test report. Further enquiry of validity or verification of the test report should be addressed to AGC by agc@agc-cert.com.



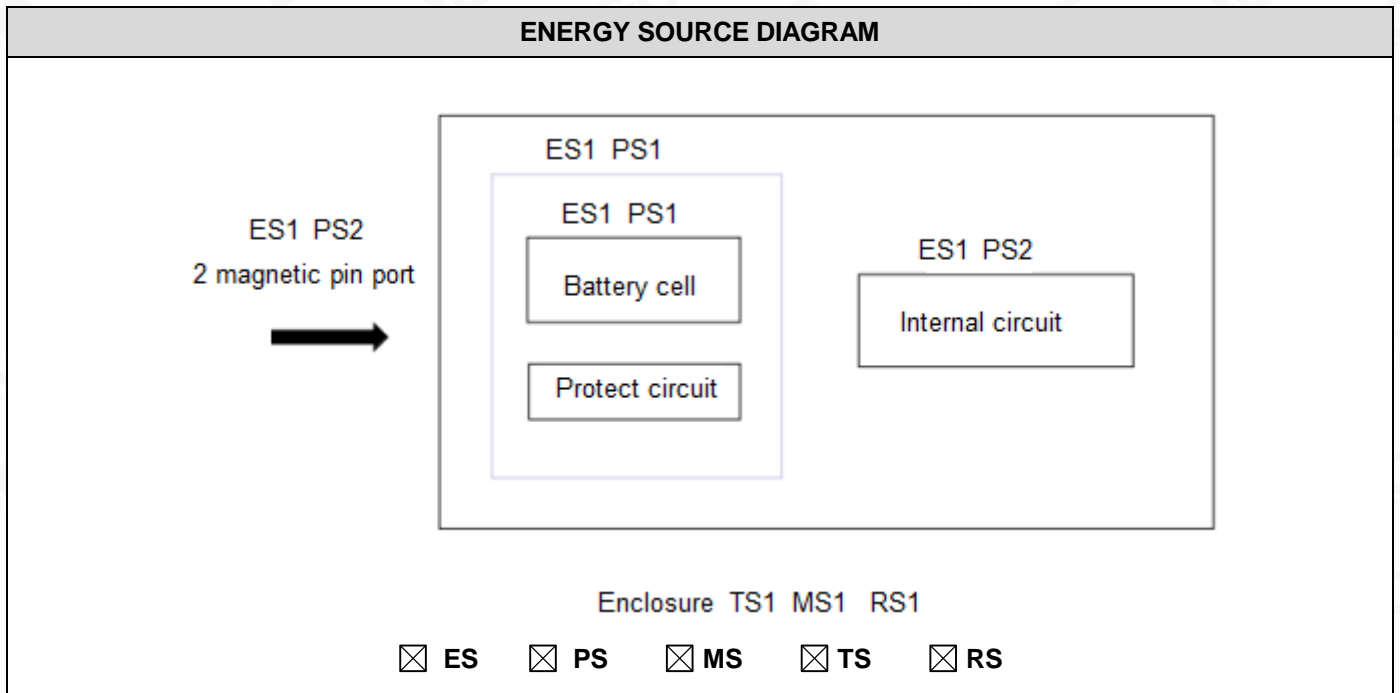

Any report having not been signed by authorized approver, or having been altered without authorization, or having not been stamped by the "Dedicated Testing/Inspection Stamp" is deemed to be invalid. Copying or excerpting portion of, or altering the content of the report is not permitted without the written authorization of AGC. The test results presented in the report apply only to the tested sample. Any objections to report issued by AGC should be submitted to AGC within 15 days after the issuance of the test report. Further enquiry of validity or verification of the test report should be addressed to AGC by agc@agc-cert.com.



OVERVIEW OF EMPLOYED SAFEGUARDS				
Clause	Possible Hazard			
5.1	Electrically-caused injury			
Body Part (e.g. Ordinary)	Energy Source (ES3: Primary Filter circuit)	Safeguards		
		Basic	Supplementary	Reinforced (Enclosure)
Ordinary person	ES1	N/A	N/A	N/A
6.1	Electrically-caused fire			
Material part (e.g. mouse enclosure)	Energy Source (PS2: 100 Watt circuit)	Safeguards		
		Basic	Supplementary	Reinforced
All Flammable materials inside and plastic enclosure	PS2: 2 magnetic pin port PS2: Internal circuits PS1: Battery pack PS1: Battery cell	1. No ignition occurred. 2. No parts exceeding 90% of its spontaneous ignition temperature.	1. PCB is complied with V-0 material; 2. all other components: at least V-2 except for mounted on min. V-1 material or small parts of combustible material	N/A
7.1	Injury caused by hazardous substances			
Body Part (e.g., skilled)	Energy Source (hazardous material)	Safeguards		
		Basic	Supplementary	Reinforced
Complied with annex M	Li-ion Battery	N/A	N/A	N/A
8.1	Mechanically-caused injury			
Body Part (e.g. Ordinary)	Energy Source (MS3:High Pressure Lamp)	Safeguards		
		Basic	Supplementary	Reinforced (Enclosure)
Ordinary person	MS1: Edges and corners	N/A	N/A	N/A
Ordinary person	MS1: Equipment mass	N/A	N/A	N/A
Ordinary person	MS1: Internal DC motor	N/A	N/A	N/A
9.1	Thermal Burn			
Body Part (e.g., Ordinary)	Energy Source (TS2)	Safeguards		
		Basic	Supplementary	Reinforced
Ordinary person	TS1: Accessible plastic enclosure	N/A	N/A	N/A
10.1	Radiation			
Body Part (e.g., Ordinary)	Energy Source (Output from audio port)	Safeguards		
		Basic	Supplementary	Reinforced
Ordinary person	RS1: Indicator LED	N/A	N/A	N/A

Any report having not been signed by authorized approver, or having been altered without authorization, or having not been stamped by the "Dedicated Testing/Inspection Stamp" is deemed to be invalid. Copying or excerpting portion of, or altering the content of the report is not permitted without the written authorization of AGC. The test results presented in the report apply only to the tested sample. Any objections to report issued by AGC should be submitted to AGC within 15 days after the issuance of the test report. Further enquiry of validity or verification of the test report should be addressed to AGC by agc@agc-cert.com.



Supplementary Information:

- (1) See attached energy source diagram for additional details.
- (2) "N" – Normal Condition; "A" – Abnormal Condition; "S" Single Fault

Any report having not been signed by authorized approver, or having been altered without authorization, or having not been stamped by the "Dedicated Testing/Inspection Stamp" is deemed to be invalid. Copying or excerpting portion of, or altering the content of the report is not permitted without the written authorization of AGC. The test results presented in the report apply only to the tested sample. Any objections to report issued by AGC should be submitted to AGC within 15days after the issuance of the test report. Further enquiry of validity or verification of the test report should be addressed to AGC by agc@agc-cert.com.

Attestation of Global Compliance(Shenzhen)Co., Ltd
Attestation of Global Compliance(Shenzhen)Std & Tech Co., Ltd
Tel: +86-755 2523 4088 E-mail: agc@agc-cert.com Web: <http://cn.agc-cert.com/>



EN 62368-1			
Clause	Requirement – Test	Result - Remark	Verdict
4	GENERAL REQUIREMENTS		P
4.1.1	Acceptance of materials, components and subassemblies	See appended table 4.1.2	P
4.1.2	Use of components	Components which are certified to IEC and/or national standards are used correctly within their ratings. Components not covered by IEC standards are tested under the conditions present in the equipment.	P
4.1.3	Equipment design and construction	No accessible part which could cause injury	P
4.1.15	Markings and instructions	(See Annex F)	P
4.4.4	Safeguard robustness	See below	P
4.4.4.2	Steady force tests	(See Annex T.4)	P
4.4.4.3	Drop tests.....	(See Annex T.7)	P
4.4.4.4	Impact tests		N
4.4.4.5	Internal accessible safeguard enclosure and barrier tests		N
4.4.4.6	Glass Impact tests		N
4.4.4.7	Thermoplastic material tests.....	(See Annex T.8)	P
4.4.4.8	Air comprising a safeguard		N
4.4.4.9	Accessibility and safeguard effectiveness	No damaged	P
4.5	Explosion	No explosion occurs during normal/abnormal operation and single fault conditions	P
4.6	Fixing of conductors		N
4.6.1	Fix conductors not to defeat a safeguard		N
4.6.2	10 N force test applied to		N
4.7	Equipment for direct insertion into mains socket - outlets		N
4.7.2	Mains plug part complies with the relevant standard		N
4.7.3	Torque (Nm)		N
4.8	Products containing coin/button cell batteries	No coin/button batteries used.	N
4.8.2	Instructional safeguard		N

Any report having not been signed by authorized approver, or having been altered without authorization, or having not been stamped by the "Dedicated Testing/Inspection Stamp" is deemed to be invalid. Copying or excerpting portion of, or altering the content of the report is not permitted without the written authorization of AGC. The test results presented in the report apply only to the tested sample. Any objections to report issued by AGC should be submitted to AGC within 15 days after the issuance of the test report. Further enquiry of validity or verification of the test report should be addressed to AGC by agc@agc-cert.com.



EN 62368-1			
Clause	Requirement – Test	Result - Remark	Verdict
4.8.3	Battery Compartment Construction		N
	Means to reduce the possibility of children removing the battery		—
4.8.4	Battery Compartment Mechanical Tests.....		N
4.8.5	Battery Accessibility		N
4.9	Likelihood of fire or shock due to entry of conductive object	(See Annex P)	P

5	ELECTRICALLY-CAUSED INJURY		P
5.2.1	Electrical energy source classifications.....	(See appended table 5.2)	P
5.2.2	ES1, ES2 and ES3 limits	ES1	P
5.2.2.2	Steady-state voltage and current	See appended table 5.2)	P
5.2.2.3	Capacitance limits		N
5.2.2.4	Single pulse limits	No such single pulses with the EUT	N
5.2.2.5	Limits for repetitive pulses	No such repetitive pulses with the EUT	N
5.2.2.6	Ringing signals	No such ringing signals with the EUT	N
5.2.2.7	Audio signals		N
5.3	Protection against electrical energy sources	ES1	N
5.3.1	General Requirements for accessible parts to ordinary, instructed and skilled persons		N
5.3.2.1	Accessibility to electrical energy sources and safeguards		N
5.3.2.2	Contact requirements		N
	a) Test with test probe from Annex V		N
	b) Electric strength test potential (V)		N
	c) Air gap (mm)		N
5.3.2.4	Terminals for connecting stripped wire		N
5.4	Insulation materials and requirements		N
5.4.1.2	Properties of insulating material		N
5.4.1.3	Humidity conditioning		N
5.4.1.4	Maximum operating temperature for insulating materials		N
5.4.1.5	Pollution degree		—

Any report having not been signed by authorized approver, or having been altered without authorization, or having not been stamped by the "Dedicated Testing/Inspection Stamp" is deemed to be invalid. Copying or excerpting portion of, or altering the content of the report is not permitted without the written authorization of AGC. The test results presented in the report apply only to the tested sample. Any objections to report issued by AGC should be submitted to AGC within 15days after the issuance of the test report. Further enquiry of validity or verification of the test report should be addressed to AGC by agc@agc-cert.com.



EN 62368-1			
Clause	Requirement – Test	Result - Remark	Verdict
5.4.1.5.2	Test for pollution degree 1 environment and for an insulating compound		N
5.4.1.5.3	Thermal cycling		N
5.4.1.6	Insulation in transformers with varying dimensions		N
5.4.1.7	Insulation in circuits generating starting pulses		N
5.4.1.8	Determination of working voltage		N
5.4.1.9	Insulating surfaces		N
5.4.1.10	Thermoplastic parts on which conductive metallic parts are directly mounted		N
5.4.1.10.2	Vicat softening temperature		N
5.4.1.10.3	Ball pressure		N
5.4.2	Clearances		N
5.4.2.2	Determining clearance using peak working voltage		N
5.4.2.3	Determining clearance using required withstand voltage		N
	a) a.c. mains transient voltage.....		—
	b) d.c. mains transient voltage		—
	c) external circuit transient voltage.....		—
	d) transient voltage determined by measurement ...		—
5.4.2.4	Determining the adequacy of a clearance using an electric strength test		N
5.4.2.5	Multiplication factors for clearances and test voltages.....		N
5.4.3	Creepage distances.....		N
5.4.3.1	General		N
5.4.3.3	Material Group		—
5.4.4	Solid insulation		N
5.4.4.2	Minimum distance through insulation		N
5.4.4.3	Insulation compound forming solid insulation		N
5.4.4.4	Solid insulation in semiconductor devices		N
5.4.4.5	Cemented joints		N
5.4.4.6	Thin sheet material		N
5.4.4.6.1	General requirements		N
5.4.4.6.2	Separable thin sheet material		N

Any report having not been signed by authorized approver, or having been altered without authorization, or having not been stamped by the "Dedicated Testing/Inspection Stamp" is deemed to be invalid. Copying or excerpting portion of, or altering the content of the report is not permitted without the written authorization of AGC. The test results presented in the report apply only to the tested sample. Any objections to report issued by AGC should be submitted to AGC within 15days after the issuance of the test report. Further enquiry of validity or verification of the test report should be addressed to AGC by agc@agc-cert.com.



EN 62368-1			
Clause	Requirement – Test	Result - Remark	Verdict
	Number of layers (pcs)		N
5.4.4.6.3	Non-separable thin sheet material		N
5.4.4.6.4	Standard test procedure for non-separable thin sheet material		N
5.4.4.6.5	Mandrel test		N
5.4.4.7	Solid insulation in wound components		N
5.4.4.9	Solid insulation at frequencies >30 kHz		N
5.4.5	Antenna terminal insulation		N
5.4.5.1	General		N
5.4.5.2	Voltage surge test		N
	Insulation resistance (MΩ)		—
5.4.6	Insulation of internal wire as part of supplementary safeguard		N
5.4.7	Tests for semiconductor components and for cemented joints		N
5.4.8	Humidity conditioning		N
	Relative humidity (%)		—
	Temperature (°C)		—
	Duration (h)		—
5.4.9	Electric strength test		N
5.4.9.1	Test procedure for a solid insulation type test		N
5.4.9.2	Test procedure for routine tests		N
5.4.10	Protection against transient voltages between external circuit		N
5.4.10.1	Parts and circuits separated from external circuits		N
5.4.10.2	Test methods		N
5.4.10.2.1	General		N
5.4.10.2.2	Impulse test		N
5.4.10.2.3	Steady-state test		N
5.4.11	Insulation between external circuits and earthed circuitry		N
5.4.11.1	Exceptions to separation between external circuits and earth		N
5.4.11.2	Requirements		N

Any report having not been signed by authorized approver, or having been altered without authorization, or having not been stamped by the "Dedicated Testing/Inspection Stamp" is deemed to be invalid. Copying or excerpting portion of, or altering the content of the report is not permitted without the written authorization of AGC. The test results presented in the report apply only to the tested sample. Any objections to report issued by AGC should be submitted to AGC within 15 days after the issuance of the test report. Further enquiry of validity or verification of the test report should be addressed to AGC by agc@agc-cert.com.



EN 62368-1			
Clause	Requirement – Test	Result - Remark	Verdict
	Rated operating voltage U_{op} (V)		—
	Nominal voltage U_{peak} (V)		—
	Max increase due to variation U_{sp}		—
	Max increase due to ageing ΔU_{sa}		—
	$U_{op} = U_{peak} + \Delta U_{sp} + \Delta U_{sa}$		—
5.5	Components as safeguards		N
5.5.1	General		N
5.5.2	Capacitors and RC units		N
5.5.2.1	General requirement		N
5.5.2.2	Safeguards against capacitor discharge after disconnection of a connector		N
5.5.3	Transformers		N
5.5.4	Optocouplers		N
5.5.5	Relays		N
5.5.6	Resistors		N
5.5.7	SPD's		N
5.5.7.1	Use of an SPD connected to reliable earthing		N
5.5.7.2	Use of an SPD between mains and protective earth		N
5.5.8	Insulation between the mains and external circuit consisting of a coaxial cable		N
5.6	Protective conductor		N
5.6.2	Requirement for protective conductors		N
5.6.2.1	General requirements		N
5.6.2.2	Colour of insulation		N
5.6.3	Requirement for protective earthing conductors		N
	Protective earthing conductor size (mm^2)		—
5.6.4	Requirement for protective bonding conductors		N
5.6.4.1	Protective bonding conductors		N
	Protective bonding conductor size (mm^2)		—
	Protective current rating (A)		—
5.6.4.3	Current limiting and overcurrent protective devices		N
5.6.5	Terminals for protective conductors		N

Any report having not been signed by authorized approver, or having been altered without authorization, or having not been stamped by the "Dedicated Testing/Inspection Stamp" is deemed to be invalid. Copying or excerpting portion of, or altering the content of the report is not permitted without the written authorization of AGC. The test results presented in the report apply only to the tested sample. Any objections to report issued by AGC should be submitted to AGC within 15 days after the issuance of the test report. Further enquiry of validity or verification of the test report should be addressed to AGC by agc@agc-cert.com.



EN 62368-1			
Clause	Requirement – Test	Result - Remark	Verdict
5.6.5.1	Requirement		N
	Conductor size (mm ²), nominal thread diameter (mm)..... :		N
5.6.5.2	Corrosion		N
5.6.6	Resistance of the protective system		N
5.6.6.1	Requirements		N
5.6.6.2	Test Method Resistance (Ω)..... :		N
5.6.7	Reliable earthing		N
5.7	Prospective touch voltage, touch current and protective conductor current		N
5.7.2	Measuring devices and networks		N
5.7.2.1	Measurement of touch current..... :		N
5.7.2.2	Measurement of prospective touch voltage		N
5.7.3	Equipment set-up, supply connections and earth connections		N
	System of interconnected equipment (separate connections/single connection)..... :		—
	Multiple connections to mains (one connection at a time/simultaneous connections)..... :		—
5.7.4	Earthed conductive accessible parts..... :		N
5.7.5	Protective conductor current		N
	Supply Voltage (V)..... :		—
	Measured current (mA)..... :		—
	Instructional Safeguard..... :		N
5.7.6	Prospective touch voltage and touch current due to external circuits		N
5.7.6.1	Touch current from coaxial cables		N
5.7.6.2	Prospective touch voltage and touch current from external circuits		N
5.7.7	Summation of touch currents from external circuits		N
	a) Equipment with earthed external circuits Measured current (mA)..... :		N
	b) Equipment whose external circuits are not referenced to earth. Measured current (mA)..... :		N

Any report having not been signed by authorized approver, or having been altered without authorization, or having not been stamped by the "Dedicated Testing/Inspection Stamp" is deemed to be invalid. Copying or excerpting portion of, or altering the content of the report is not permitted without the written authorization of AGC. The test results presented in the report apply only to the tested sample. Any objections to report issued by AGC should be submitted to AGC within 15days after the issuance of the test report. Further enquiry of validity or verification of the test report should be addressed to AGC by agc@agc-cert.com.



EN 62368-1			
Clause	Requirement – Test	Result - Remark	Verdict
6	ELECTRICALLY- CAUSED FIRE		P
6.2.2	Power source circuit classifications	PS (power source) classification determined by measuring the maximum power in Figures 34 and 35 for load and power source circuits.	P
6.2.2.1	General	See the following details.	P
6.2.2.2	Power measurement for worst-case load fault	(See appended table 6.2.2)	P
6.2.2.3	Power measurement for worst-case power source fault	(See appended table 6.2.2)	P
6.2.2.4	PS1		P
6.2.2.5	PS2	(See appended table 6.2.2)	P
6.2.2.6	PS3		N
6.2.3	Classification of potential ignition sources		P
6.2.3.1	Arcing PIS		N
6.2.3.2	Resistive PIS		N
6.3	Safeguards against fire under normal operating and abnormal operating conditions		P
6.3.1 (a)	No ignition and attainable temperature value less than 90 % defined by ISO 871 or less than 300 °C for unknown materials.....	(See appended table 5.4.1.5, 6.3.2, 9.0, B.2.6)	P
6.3.1 (b)	Combustible materials outside fire enclosure	No such materials used.	N
6.4	Safeguards against fire under single fault conditions		P
6.4.1	Safeguard Method	Method by control fire spread.	P
6.4.2	Reduction of the likelihood of ignition under single fault conditions in PS1 circuits		N
6.4.3	Reduction of the likelihood of ignition under single fault conditions in PS2 and PS3 circuits		N
6.4.3.1	General		N
6.4.3.2	Supplementary Safeguards		N
	Special conditions if conductors on printed boards are opened or peeled	No such case happened.	N
6.4.3.3	Single Fault Conditions.....		N
	Special conditions for temperature limited by fuse		N
6.4.4	Control of fire spread in PS1 circuits		P
6.4.5	Control of fire spread in PS2 circuits		P

Any report having not been signed by authorized approver, or having been altered without authorization, or having not been stamped by the "Dedicated Testing/Inspection Stamp" is deemed to be invalid. Copying or excerpting portion of, or altering the content of the report is not permitted without the written authorization of AGC. The test results presented in the report apply only to the tested sample. Any objections to report issued by AGC should be submitted to AGC within 15 days after the issuance of the test report. Further enquiry of validity or verification of the test report should be addressed to AGC by agc@agc-cert.com.



EN 62368-1			
Clause	Requirement – Test	Result - Remark	Verdict
6.4.5.2	Supplementary safeguards	(See appended tables 4.1.2 and Annex G) PCB: V-0	P
6.4.6	Control of fire spread in PS3 circuit		N
6.4.7	Separation of combustible materials from a PIS		N
6.4.7.1	General		N
6.4.7.2	Separation by distance		N
6.4.7.3	Separation by a fire barrier		N
6.4.8	Fire enclosures and fire barriers		N
6.4.8.1	Fire enclosure and fire barrier material properties		N
6.4.8.2.1	Requirements for a fire barrier	No such construction.	N
6.4.8.2.2	Requirements for a fire enclosure		N
6.4.8.3	Constructional requirements for a fire enclosure and a fire barrier		N
6.4.8.3.1	Fire enclosure and fire barrier openings		N
6.4.8.3.2	Fire barrier dimensions	No barrier used.	N
6.4.8.3.3	Top Openings in Fire Enclosure: dimensions (mm) :		N
	Needle Flame test		N
6.4.8.3.4	Bottom Openings in Fire Enclosure, condition met a), b) and/or c) dimensions (mm)		N
	Flammability tests for the bottom of a fire enclosure		N
6.4.8.3.5	Integrity of the fire enclosure, condition met: a), b) or c).....		N
6.4.8.4	Separation of PIS from fire enclosure and fire barrier distance (mm) or flammability rating		N
6.5	Internal and external wiring		N
6.5.1	Requirements		N
6.5.2	Cross-sectional area (mm ²)		—
6.5.3	Requirements for interconnection to building wiring.....	No such interconnection to building wiring.	N
6.6	Safeguards against fire due to connection to additional equipment		N
	External port limited to PS2 or complies with Clause Q.1		N

Any report having not been signed by authorized approver, or having been altered without authorization, or having not been stamped by the "Dedicated Testing/Inspection Stamp" is deemed to be invalid. Copying or excerpting portion of, or altering the content of the report is not permitted without the written authorization of AGC. The test results presented in the report apply only to the tested sample. Any objections to report issued by AGC should be submitted to AGC within 15 days after the issuance of the test report. Further enquiry of validity or verification of the test report should be addressed to AGC by agc@agc-cert.com.



EN 62368-1			
Clause	Requirement – Test	Result - Remark	Verdict
7	INJURY CAUSED BY HAZARDOUS SUBSTANCES		P
7.2	Reduction of exposure to hazardous substances	No hazardous chemicals within the equipment.	N
7.3	Ozone exposure	No ozone production within the equipment.	N
7.4	Use of personal safeguards (PPE)	No such consideration.	N
	Personal safeguards and instructions..... :		—
7.5	Use of instructional safeguards and instructions	No chemical-caused injuries, the instruction safeguard was not required.	N
	Instructional safeguard (ISO 7010) :		—
7.6	Batteries..... :	Complied with Annex M	P

8	MECHANICALLY-CAUSED INJURY		P
8.1	General	See the following details.	P
8.2	Mechanical energy source classifications	Edges and corners, classified as MS1 Equipment mass < 7 kg, classified as MS1 Internal DC motor classified as MS1	P
8.3	Safeguards against mechanical energy sources	MS1	P
8.4	Safeguards against parts with sharp edges and corners	Accessible edges and corners of the equipment are rounded and are classified as MS1.	P
8.4.1	Safeguards		N
8.5	Safeguards against moving parts		N
8.5.1	MS2 or MS3 part required to be accessible for the function of the equipment		N
8.5.2	Instructional Safeguard..... :		—
8.5.4	Special categories of equipment comprising moving parts		N
8.5.4.1	Large data storage equipment		N
8.5.4.2	Equipment having electromechanical device for destruction of media		N
8.5.4.2.1	Safeguards and Safety Interlocks :		N
8.5.4.2.2	Instructional safeguards against moving parts		N

Any report having not been signed by authorized approver, or having been altered without authorization, or having not been stamped by the "Dedicated Testing/Inspection Stamp" is deemed to be invalid. Copying or excerpting portion of, or altering the content of the report is not permitted without the written authorization of AGC. The test results presented in the report apply only to the tested sample. Any objections to report issued by AGC should be submitted to AGC within 15days after the issuance of the test report. Further enquiry of validity or verification of the test report should be addressed to AGC by agc@agc-cert.com.



EN 62368-1			
Clause	Requirement – Test	Result - Remark	Verdict
	Instructional Safeguard..... :		—
8.5.4.2.3	Disconnection from the supply		N
8.5.4.2.4	Probe type and force (N) :		N
8.5.5	High Pressure Lamps		N
8.5.5.1	Energy Source Classification		N
8.5.5.2	High Pressure Lamp Explosion Test :		N
8.6	Stability	< 7 kg	N
8.6.1	Product classification		N
	Instructional Safeguard..... :		—
8.6.2	Static stability		N
8.6.2.2	Static stability test		N
	Applied Force..... :		—
8.6.2.3	Downward Force Test		N
8.6.3	Relocation stability test		N
	Unit configuration during 10° tilt :		—
8.6.4	Glass slide test		N
8.6.5	Horizontal force test (Applied Force)..... :		N
	Position of feet or movable parts..... :		—
8.7	Equipment mounted to wall or ceiling		N
8.7.1	Mounting Means (Length of screws (mm) and mounting surface) :		N
8.7.2	Direction and applied force..... :		N
8.8	Handles strength		N
8.8.1	Classification		N
8.8.2	Applied Force :		N
8.9	Wheels or casters attachment requirements		N
8.9.1	Classification		N
8.9.2	Applied force :		—
8.10	Carts, stands and similar carriers	No such device provided within the EUT.	N
8.10.1	General		N
8.10.2	Marking and instructions		N
	Instructional Safeguard..... :		—

Any report having not been signed by authorized approver, or having been altered without authorization, or having not been stamped by the "Dedicated Testing/Inspection Stamp" is deemed to be invalid. Copying or excerpting portion of, or altering the content of the report is not permitted without the written authorization of AGC. The test results presented in the report apply only to the tested sample. Any objections to report issued by AGC should be submitted to AGC within 15 days after the issuance of the test report. Further enquiry of validity or verification of the test report should be addressed to AGC by agc@agc-cert.com.



EN 62368-1			
Clause	Requirement – Test	Result - Remark	Verdict
8.10.3	Cart, stand or carrier loading test and compliance		N
	Applied force		—
8.10.4	Cart, stand or carrier impact test		N
8.10.5	Mechanical stability		N
	Applied horizontal force (N)		—
8.10.6	Thermoplastic temperature stability (°C).....		N
8.11	Mounting means for rack mounted equipment		N
8.11.1	General		N
8.11.2	Product Classification		N
8.11.3	Mechanical strength test, variable N		N
8.11.4	Mechanical strength test 250N, including end stops		N
8.12	Telescoping or rod antennas.....	No such device provided within the EUT.	N
	Button/Ball diameter (mm)		—

9	THERMAL BURN INJURY		P
9.2	Thermal energy source classifications	All accessible surfaces are classified as TS1, see appended table 5.4.1.4, 6.3.2, 9.0, B.2.6	P
9.3	Safeguard against thermal energy sources	See above.	P
9.4	Requirements for safeguards		P
9.4.1	Equipment safeguard	Enclosure temperatures do not exceed TS1 limits.	P
9.4.2	Instructional safeguard		N

10	RADIATION		P
10.2	Radiation energy source classification		P
10.2.1	General classification	RS1: Indicator LED	P
10.3	Protection against laser radiation		N
	Laser radiation that exists equipment:		—
	Normal, abnormal, single-fault.....		N
	Instructional safeguard.....		—
	Tool.....		—

Any report having not been signed by authorized approver, or having been altered without authorization, or having not been stamped by the "Dedicated Testing/Inspection Stamp" is deemed to be invalid. Copying or excerpting portion of, or altering the content of the report is not permitted without the written authorization of AGC. The test results presented in the report apply only to the tested sample. Any objections to report issued by AGC should be submitted to AGC within 15days after the issuance of the test report. Further enquiry of validity or verification of the test report should be addressed to AGC by agc@agc-cert.com.



EN 62368-1			
Clause	Requirement – Test	Result - Remark	Verdict
10.4	Protection against visible, infrared, and UV radiation		N
10.4.1	General		N
10.4.1.a)	RS3 for Ordinary and instructed persons.....:		N
10.4.1.b)	RS3 accessible to a skilled person		N
	Personal safeguard (PPE) instructional safeguard		—
10.4.1.c)	Equipment visible, IR, UV does not exceed RS1 .. :		N
10.4.1.d)	Normal, abnormal, single-fault conditions		N
10.4.1.e)	Enclosure material employed as safeguard is opaque		N
10.4.1.f)	UV attenuation		N
10.4.1.g)	Materials resistant to degradation UV		N
10.4.1.h)	Enclosure containment of optical radiation		N
10.4.1.i)	Exempt Group under normal operating conditions		N
10.4.2	Instructional safeguard.....:		N
10.5	Protection against x-radiation	No such x-radiation generated from the equipment.	N
10.5.1	X- radiation energy source that exists equipment :		N
	Normal, abnormal, single fault conditions		N
	Equipment safeguards		N
	Instructional safeguard for skilled person		N
10.5.3	Most unfavourable supply voltage to give maximum radiation		—
	Abnormal and single-fault condition.....:		N
	Maximum radiation (pA/kg).....:		N
10.6	Protection against acoustic energy sources		N
10.6.1	General		N
10.6.2	Classification		N
	Acoustic output, dB(A)		N
	Output voltage, unweighted r.m.s.:		N
10.6.4	Protection of persons		N
	Instructional safeguards.....:		N

Any report having not been signed by authorized approver, or having been altered without authorization, or having not been stamped by the "Dedicated Testing/Inspection Stamp" is deemed to be invalid. Copying or excerpting portion of, or altering the content of the report is not permitted without the written authorization of AGC. The test results presented in the report apply only to the tested sample. Any objections to report issued by AGC should be submitted to AGC within 15 days after the issuance of the test report. Further enquiry of validity or verification of the test report should be addressed to AGC by agc@agc-cert.com.



EN 62368-1			
Clause	Requirement – Test	Result - Remark	Verdict
	Equipment safeguard prevent ordinary person to RS2		—
	Means to actively inform user of increase sound pressure		—
	Equipment safeguard prevent ordinary person to RS2		—
10.6.5	Requirements for listening devices (headphones, earphones, etc.)		N
10.6.5.1	Corded passive listening devices with analog input		N
	Input voltage with 94 dB(A) L_{Aeq} acoustic pressure output		—
10.6.5.2	Corded listening devices with digital input		N
	Maximum dB(A)		—
10.6.5.3	Cordless listening device		N
	Maximum dB(A)		—

B	NORMAL OPERATING CONDITION TESTS, ABNORMAL OPERATING CONDITION TESTS AND SINGLE FAULT CONDITION TESTS		P
B.2	Normal Operating Conditions	See the following details.	P
B.2.1	General requirements	(See Test Item Particulars and appended test tables)	P
	Audio Amplifiers and equipment with audio amplifiers		N
B.2.3	Supply voltage and tolerances	(See appended table B.2.5)	P
B.2.5	Input test	(See appended table B.2.5)	P
B.3	Simulated abnormal operating conditions		N
B.3.1	General requirements		N
B.3.2	Covering of ventilation openings	No ventilation openings provided.	N
B.3.3	D.C. mains polarity test		N
B.3.4	Setting of voltage selector	No setting of voltage selector within the EUT	N
B.3.5	Maximum load at output terminals.....	No such terminals.	N
B.3.6	Reverse battery polarity	Impossible reverse polarity by inherent design.	N
B.3.7	Abnormal operating conditions as specified in Clause E.2.		N

Any report having not been signed by authorized approver, or having been altered without authorization, or having not been stamped by the "Dedicated Testing/Inspection Stamp" is deemed to be invalid. Copying or excerpting portion of, or altering the content of the report is not permitted without the written authorization of AGC. The test results presented in the report apply only to the tested sample. Any objections to report issued by AGC should be submitted to AGC within 15 days after the issuance of the test report. Further enquiry of validity or verification of the test report should be addressed to AGC by agc@agc-cert.com.



EN 62368-1			
Clause	Requirement – Test	Result - Remark	Verdict
B.3.8	Safeguards functional during and after abnormal operating conditions		N
B.4	Simulated single fault conditions		P
B.4.2	Temperature controlling device open or short-circuited		N
B.4.3	Motor tests		P
B.4.3.1	Motor blocked or rotor locked increasing the internal ambient temperature	(See appended table B.4)	P
B.4.4	Short circuit of functional insulation	See the following details.	P
B.4.4.1	Short circuit of clearances for functional insulation	(See appended table B.3 &B.4)	P
B.4.4.2	Short circuit of creepage distances for functional insulation	(See appended table B.3 &B.4)	P
B.4.4.3	Short circuit of functional insulation on coated printed boards	No coated printed boards within the EUT	N
B.4.5	Short circuit and interruption of electrodes in tubes and semiconductors		P
B.4.6	Short circuit or disconnect of passive components	(See appended table B.3 &B.4)	P
B.4.7	Continuous operation of components	The EUT is continuous operating type and no such components intended for short time operation or intermittent operation	N
B.4.8	Class 1 and Class 2 energy sources within limits during and after single fault conditions	(See appended table B.3&B.4)	P
B.4.9	Battery charging under single fault conditions	Complied with the annex M	P

C	UV RADIATION		N
C.1	Protection of materials in equipment from UV radiation	No such UV generated from the equipment.	N
C.1.2	Requirements		N
C.1.3	Test method		N
C.2	UV light conditioning test		N
C.2.1	Test apparatus		N
C.2.2	Mounting of test samples		N
C.2.3	Carbon-arc light-exposure apparatus		N
C.2.4	Xenon-arc light exposure apparatus		N

Any report having not been signed by authorized approver, or having been altered without authorization, or having not been stamped by the "Dedicated Testing/Inspection Stamp" is deemed to be invalid. Copying or excerpting portion of, or altering the content of the report is not permitted without the written authorization of AGC. The test results presented in the report apply only to the tested sample. Any objections to report issued by AGC should be submitted to AGC within 15days after the issuance of the test report. Further enquiry of validity or verification of the test report should be addressed to AGC by agc@agc-cert.com.



EN 62368-1			
Clause	Requirement – Test	Result - Remark	Verdict
D	TEST GENERATORS		N
D.1	Impulse test generators	No such consideration.	N
D.2	Antenna interface test generator		N
D.3	Electronic pulse generator		N

E	TEST CONDITIONS FOR EQUIPMENT CONTAINING AUDIO AMPLIFIERS		N
E.1	Audio amplifier normal operating conditions		N
	Audio signal voltage (V)		—
	Rated load impedance (Ω)		—
E.2	Audio amplifier abnormal operating conditions		N

F	EQUIPMENT MARKINGS, INSTRUCTIONS, AND INSTRUCTIONAL SAFEGUARDS		P
F.1	General requirements	See the following details.	P
	Instructions – Language	English	—
F.2	Letter symbols and graphical symbols	See the following details.	P
F.2.1	Letter symbols according to IEC60027-1	Letter symbols for quantities and units are complied with IEC 60027-1.	P
F.2.2	Graphic symbols IEC, ISO or manufacturer specific	Graphical symbols are complied with IEC 60417, ISO 3864-2, ISO 7000 or ISO 7010.	P
F.3	Equipment markings		P
F.3.1	Equipment marking locations	Equipment marking is located on the exterior surface and is easily visible.	P
F.3.2	Equipment identification markings	See the following details.	P
F.3.2.1	Manufacturer identification	See copy of marking plate.	—
F.3.2.2	Model identification	See copy of marking plate.	—
F.3.3	Equipment rating markings	Provided.	P
F.3.3.1	Equipment with direct connection to mains		N
F.3.3.2	Equipment without direct connection to mains		P
F.3.3.3	Nature of supply voltage		—
F.3.3.4	Rated voltage		—
F.3.3.4	Rated frequency		—
F.3.3.6	Rated current or rated power		—
F.3.3.7	Equipment with multiple supply connections	Only one supply connection.	N

Any report having not been signed by authorized approver, or having been altered without authorization, or having not been stamped by the "Dedicated Testing/Inspection Stamp" is deemed to be invalid. Copying or excerpting portion of, or altering the content of the report is not permitted without the written authorization of AGC. The test results presented in the report apply only to the tested sample. Any objections to report issued by AGC should be submitted to AGC within 15 days after the issuance of the test report. Further enquiry of validity or verification of the test report should be addressed to AGC by agc@agc-cert.com.



EN 62368-1			
Clause	Requirement – Test	Result - Remark	Verdict
F.3.4	Voltage setting device	No such device on the equipment.	N
F.3.5	Terminals and operating devices		N
F.3.5.1	Mains appliance outlet and socket-outlet markings :	No such devices on the equipment.	N
F.3.5.2	Switch position identification marking :	No such switch on the equipment.	N
F.3.5.3	Replacement fuse identification and rating markings :		N
F.3.5.4	Replacement battery identification marking..... :		N
F.3.5.5	Terminal marking location		N
F.3.6	Equipment markings related to equipment classification	Class III	N
F.3.6.1	Class I Equipment		N
F.3.6.1.1	Protective earthing conductor terminal		N
F.3.6.1.2	Neutral conductor terminal		N
F.3.6.1.3	Protective bonding conductor terminals		N
F.3.6.2	Class II equipment (IEC60417-5172)		N
F.3.6.2.1	Class II equipment with or without functional earth		N
F.3.6.2.2	Class II equipment with functional earth terminal marking		N
F.3.7	Equipment IP rating marking :	This equipment is classified as IPX0.	—
F.3.8	External power supply output marking		N
F.3.9	Durability, legibility and permanence of marking	See the following details.	P
F.3.10	Test for permanence of markings	The label was subjected to the permanence of marking test, 15 sec. for water and 15 sec. for petroleum spirit. After each test, the marking remained legible.	P
F.4	Instructions		P
	a) Equipment for use in locations where children not likely to be present - marking		N
	b) Instructions given for installation or initial use	Relevant safety caution texts and installation instruction are available.	P
	c) Equipment intended to be fastened in place		N
	d) Equipment intended for use only in restricted access area		N

Any report having not been signed by authorized approver, or having been altered without authorization, or having not been stamped by the "Dedicated Testing/Inspection Stamp" is deemed to be invalid. Copying or excerpting portion of, or altering the content of the report is not permitted without the written authorization of AGC. The test results presented in the report apply only to the tested sample. Any objections to report issued by AGC should be submitted to AGC within 15 days after the issuance of the test report. Further enquiry of validity or verification of the test report should be addressed to AGC by agc@agc-cert.com.



EN 62368-1			
Clause	Requirement – Test	Result - Remark	Verdict
	e) Audio equipment terminals classified as ES3 and other equipment with terminals marked in accordance F.3.6.1		N
	f) Protective earthing employed as safeguard		N
	g) Protective earthing conductor current exceeding ES 2 limits		N
	h) Symbols used on equipment		P
	i) Permanently connected equipment not provided with all-pole mains switch	The EUT is not a permanently connected equipment	N
	j) Replaceable components or modules providing safeguard function		N
F.5	Instructional safeguards		P
	Where “instructional safeguard” is referenced in the test report it specifies the required elements, location of marking and/or instruction		P

G	COMPONENTS		P
G.1	Switches		N
G.1.1	General requirements	No such switch as disconnect devices provided within the equipment.	N
G.1.2	Ratings, endurance, spacing, maximum load		N
G.2	Relays		N
G.2.1	General requirements	No such relay provided within the equipment.	N
G.2.2	Overload test		N
G.2.3	Relay controlling connectors supply power		N
G.2.4	Mains relay, modified as stated in G.2		N
G.3	Protection Devices		N
G.3.1	Thermal cut-offs	No thermal cut-off provided within the equipment.	N
G.3.1.1a) &b)	Thermal cut-outs separately approved according to IEC 60730 with conditions indicated in a) & b)		N
G.3.1.1c)	Thermal cut-outs tested as part of the equipment as indicated in c)		N
G.3.1.2	Thermal cut-off connections maintained and secure		N

Any report having not been signed by authorized approver, or having been altered without authorization, or having not been stamped by the “Dedicated Testing/Inspection Stamp” is deemed to be invalid. Copying or excerpting portion of, or altering the content of the report is not permitted without the written authorization of AGC. The test results presented in the report apply only to the tested sample. Any objections to report issued by AGC should be submitted to AGC within 15days after the issuance of the test report. Further enquiry of validity or verification of the test report should be addressed to AGC by agc@agc-cert.com.



EN 62368-1			
Clause	Requirement – Test	Result - Remark	Verdict
G.3.2	Thermal links		N
G.3.2.1a)	Thermal links separately tested with IEC 60691	No thermal link provided within the equipment.	N
G.3.2.1b)	Thermal links tested as part of the equipment		N
	Aging hours (H)..... :		—
	Single Fault Condition..... :		—
	Test Voltage (V) and Insulation Resistance (Ω) . :		—
G.3.3	PTC Thermistors	No PTC thermistor provided within the equipment.	N
G.3.4	Overcurrent protection devices		N
G.3.5	Safeguards components not mentioned in G.3.1 to G.3.5		N
G.3.5.1	Non-resettable devices suitably rated and marking provided	No such component.	N
G.3.5.2	Single faults conditions :		N
G.4	Connectors		N
G.4.1	Spacings	No such connector within the EUT	N
G.4.2	Mains connector configuration :		N
G.4.3	Plug is shaped that insertion into mains socket-outlets or appliance coupler is unlikely		N
G.5	Wound Components		N
G.5.1	Wire insulation in wound components	No such component.	N
G.5.1.2 a)	Two wires in contact inside wound component, angle between 45° and 90°		N
G.5.1.2 b)	Construction subject to routine testing		N
G.5.2	Endurance test on wound components		N
G.5.2.1	General test requirements		N
G.5.2.2	Heat run test		N
	Time (s)..... :		—
	Temperature (°C)..... :		—
G.5.2.3	Wound Components supplied by mains		N
G.5.3	Transformers		N
G.5.3.1	Requirements applied (IEC61204-7, IEC61558-1/-2, and/or IEC62368-1)		N
	Position		—
	Method of protection		—

Any report having not been signed by authorized approver, or having been altered without authorization, or having not been stamped by the "Dedicated Testing/Inspection Stamp" is deemed to be invalid. Copying or excerpting portion of, or altering the content of the report is not permitted without the written authorization of AGC. The test results presented in the report apply only to the tested sample. Any objections to report issued by AGC should be submitted to AGC within 15days after the issuance of the test report. Further enquiry of validity or verification of the test report should be addressed to AGC by agc@agc-cert.com.



EN 62368-1			
Clause	Requirement – Test	Result - Remark	Verdict
G.5.3.2	Insulation		N
	Protection from displacement of windings		—
G.5.3.3	Overload test		N
G.5.3.3.1	Test conditions		N
G.5.3.3.2	Winding Temperatures testing in the unit		N
G.5.3.3.3	Winding Temperatures - Alternative test method		N
G.5.4	Motors		P
G.5.4.1	General requirements	Only DC motor used.	P
	Position	Inside enclosure.	—
G.5.4.2	Test conditions		P
G.5.4.3	Running overload test		N
G.5.4.4	Locked-rotor overload test		N
	Test duration (days)		—
G.5.4.5	Running overload test for d.c. motors in secondary circuits		N
G.5.4.5.2	Tested in the unit		N
	Electric strength test (V)		—
G.5.4.5.3	Tested on the Bench - Alternative test method; test time (h)		N
	Electric strength test (V)		—
G.5.4.6	Locked-rotor overload test for d.c. motors in secondary circuits		P
G.5.4.6.2	Tested in the unit		N
	Maximum Temperature		N
	Electric strength test (V)		N
G.5.4.6.3	Tested on the bench - Alternative test method; test time (h)	(See appended table B.4)	P
	Electric strength test (V)		N
G.5.4.7	Motors with capacitors		N
G.5.4.8	Three-phase motors		N
G.5.4.9	Series motors		N
	Operating voltage		—
G.6	Wire Insulation		N
G.6.1	General		N

Any report having not been signed by authorized approver, or having been altered without authorization, or having not been stamped by the "Dedicated Testing/Inspection Stamp" is deemed to be invalid. Copying or excerpting portion of, or altering the content of the report is not permitted without the written authorization of AGC. The test results presented in the report apply only to the tested sample. Any objections to report issued by AGC should be submitted to AGC within 15 days after the issuance of the test report. Further enquiry of validity or verification of the test report should be addressed to AGC by agc@agc-cert.com.



EN 62368-1			
Clause	Requirement – Test	Result - Remark	Verdict
G.6.2	Solvent-based enamel wiring insulation		N
G.7	Mains supply cords		N
G.7.1	General requirements		N
	Type		—
	Rated current (A)		—
	Cross-sectional area (mm ²), (AWG).....		—
G.7.2	Compliance and test method		N
G.7.3	Cord anchorages and strain relief for non-detachable power supply cords		N
G.7.3.2	Cord strain relief		N
G.7.3.2.1	Requirements		N
	Strain relief test force (N).....		—
G.7.3.2.2	Strain relief mechanism failure		
G.7.3.2.3	Cord sheath or jacket position, distance (mm)		—
G.7.3.2.4	Strain relief comprised of polymeric material		N
G.7.4	Cord Entry		N
G.7.5	Non-detachable cord bend protection		N
G.7.5.1	Requirements		N
G.7.5.2	Mass (g)		—
	Diameter (m).....		—
	Temperature (°C).....		—
G.7.6	Supply wiring space		N
G.7.6.2	Stranded wire		N
G.7.6.2.1	Test with 8 mm strand		N
G.8	Varistors		N
G.8.1	General requirements	No VDRs.	N
G.8.2	Safeguard against shock		N
G.8.3	Safeguard against fire		N
G.8.3.2	Varistor overload test		N
G.8.3.3	Temporary overvoltage		N
G.9	Integrated Circuit (IC) Current Limiters		N
G.9.1 a)	Manufacturer defines limit at max. 5A.	No IC current limiter provided within the equipment.	N

Any report having not been signed by authorized approver, or having been altered without authorization, or having not been stamped by the "Dedicated Testing/Inspection Stamp" is deemed to be invalid. Copying or excerpting portion of, or altering the content of the report is not permitted without the written authorization of AGC. The test results presented in the report apply only to the tested sample. Any objections to report issued by AGC should be submitted to AGC within 15days after the issuance of the test report. Further enquiry of validity or verification of the test report should be addressed to AGC by agc@agc-cert.com.



EN 62368-1			
Clause	Requirement – Test	Result - Remark	Verdict
G.9.1 b)	Limiters do not have manual operator or reset		N
G.9.1 c)	Supply source does not exceed 250 VA		—
G.9.1 d)	IC limiter output current (max. 5A).....		—
G.9.1 e)	Manufacturers' defined drift		—
G.9.2	Test Program 1		N
G.9.3	Test Program 2		N
G.9.4	Test Program 3		N
G.10	Resistors		N
G.10.1	General requirements		N
G.10.2	Resistor test		N
G.10.3	Test for resistors serving as safeguards between the mains and an external circuit consisting of a coaxial cable		N
G.10.3.1	General requirements		N
G.10.3.2	Voltage surge test		N
G.10.3.3	Impulse test		N
G.11	Capacitor and RC units		N
G.11.1	General requirements		N
G.11.2	Conditioning of capacitors and RC units		N
G.11.3	Rules for selecting capacitors		N
G.12	Optocouplers		N
	Optocouplers comply with IEC 60747-5-5:2007 Spacing or Electric Strength Test (specify option and test results)		N
	Type test voltage Vini		—
	Routine test voltage, Vini,b		—
G.13	Printed boards		P
G.13.1	General requirements	See the following details.	P
G.13.2	Uncoated printed boards	The insulation between conductors on the outer surfaces of an uncoated printed board complied with the minimum clearance and creepage requirements	P
G.13.3	Coated printed boards	No coated printed board provided within the equipment.	N

Any report having not been signed by authorized approver, or having been altered without authorization, or having not been stamped by the "Dedicated Testing/Inspection Stamp" is deemed to be invalid. Copying or excerpting portion of, or altering the content of the report is not permitted without the written authorization of AGC. The test results presented in the report apply only to the tested sample. Any objections to report issued by AGC should be submitted to AGC within 15 days after the issuance of the test report. Further enquiry of validity or verification of the test report should be addressed to AGC by agc@agc-cert.com.



EN 62368-1			
Clause	Requirement – Test	Result - Remark	Verdict
G.13.4	Insulation between conductors on the same inner surface		N
	Compliance with cemented joint requirements (Specify construction)		—
G.13.5	Insulation between conductors on different surfaces		N
	Distance through insulation		N
	Number of insulation layers (pcs)		—
G.13.6	Tests on coated printed boards		N
G.13.6.1	Sample preparation and preliminary inspection		N
G.13.6.2a)	Thermal conditioning		N
G.13.6.2b)	Electric strength test		N
G.13.6.2c)	Abrasion resistance test		N
G.14	Coating on components terminals		N
G.14.1	Requirements		N
G.15	Liquid filled components		N
G.15.1	General requirements		N
G.15.2	Requirements		N
G.15.3	Compliance and test methods		N
G.15.3.1	Hydrostatic pressure test		N
G.15.3.2	Creep resistance test		N
G.15.3.3	Tubing and fittings compatibility test		N
G.15.3.4	Vibration test		N
G.15.3.5	Thermal cycling test		N
G.15.3.6	Force test		N
G.15.4	Compliance		N
G.16	IC including capacitor discharge function (ICX)		N
a)	Humidity treatment in accordance with sc5.4.8 – 120 hours		N
b)	Impulse test using circuit 2 with $U_c =$ to transient voltage		N
C1)	Application of ac voltage at 110% of rated voltage for 2.5 minutes		N
C2)	Test voltage		—

Any report having not been signed by authorized approver, or having been altered without authorization, or having not been stamped by the "Dedicated Testing/Inspection Stamp" is deemed to be invalid. Copying or excerpting portion of, or altering the content of the report is not permitted without the written authorization of AGC. The test results presented in the report apply only to the tested sample. Any objections to report issued by AGC should be submitted to AGC within 15 days after the issuance of the test report. Further enquiry of validity or verification of the test report should be addressed to AGC by agc@agc-cert.com.



EN 62368-1			
Clause	Requirement – Test	Result - Remark	Verdict
D1)	10,000 cycles on and off using capacitor with smallest capacitance resistor with largest resistance specified by manufacturer		N
D2)	Capacitance		—
D3)	Resistance		—

H	CRITERIA FOR TELEPHONE RINGING SIGNALS		N
H.1	General		N
H.2	Method A		N
H.3	Method B		N
H.3.1	Ringling signal		N
H.3.1.1	Frequency (Hz)		—
H.3.1.2	Voltage (V)		—
H.3.1.3	Cadence; time (s) and voltage (V)		—
H.3.1.4	Single fault current (mA):		—
H.3.2	Tripping device and monitoring voltage		N
H.3.2.1	Conditions for use of a tripping device or a monitoring voltage complied with		N
H.3.2.2	Tripping device		N
H.3.2.3	Monitoring voltage (V)		—

J	INSULATED WINDING WIRES FOR USE WITHOUT INTERLEAVED INSULATION		N
	General requirements		N

K	SAFETY INTERLOCKS		N
K.1	General requirements	No safety interlock provided within the equipment.	N
K.2	Components of safety interlock safeguard mechanism		N
K.3	Inadvertent change of operating mode		N
K.4	Interlock safeguard override		N
K.5	Fail-safe		N
	Compliance		N
K.6	Mechanically operated safety interlocks		N

Any report having not been signed by authorized approver, or having been altered without authorization, or having not been stamped by the "Dedicated Testing/Inspection Stamp" is deemed to be invalid. Copying or excerpting portion of, or altering the content of the report is not permitted without the written authorization of AGC. The test results presented in the report apply only to the tested sample. Any objections to report issued by AGC should be submitted to AGC within 15 days after the issuance of the test report. Further enquiry of validity or verification of the test report should be addressed to AGC by agc@agc-cert.com.



EN 62368-1			
Clause	Requirement – Test	Result - Remark	Verdict
K.6.1	Endurance requirement		N
K.6.2	Compliance and Test method :		N
K.7	Interlock circuit isolation		N
K.7.1	Separation distance for contact gaps & interlock circuit elements (type and circuit location) :		N
K.7.2	Overload test, Current (A) :		N
K.7.3	Endurance test		N
K.7.4	Electric strength test :		N

L DISCONNECT DEVICES			N
L.1	General requirements		N
L.2	Permanently connected equipment		N
L.3	Parts that remain energized		N
L.4	Single phase equipment		N
L.5	Three-phase equipment		N
L.6	Switches as disconnect devices		N
L.7	Plugs as disconnect devices		N
L.8	Multiple power sources		N

M EQUIPMENT CONTAINING BATTERIES AND THEIR PROTECTION CIRCUITS			P
M.1	General requirements		P
M.2	Safety of batteries and their cells		P
M.2.1	Requirements		P
M.2.2	Compliance and test method (identify method) ... :		P
M.3	Protection circuits		P
M.3.1	Requirements		P
M.3.2	Tests		P
	- Overcharging of a rechargeable battery	(See appended table M.3)	P
	- Unintentional charging of a non-rechargeable battery		N
	- Reverse charging of a rechargeable battery		N
	- Excessive discharging rate for any battery	(See appended table M.3)	P

Any report having not been signed by authorized approver, or having been altered without authorization, or having not been stamped by the "Dedicated Testing/Inspection Stamp" is deemed to be invalid. Copying or excerpting portion of, or altering the content of the report is not permitted without the written authorization of AGC. The test results presented in the report apply only to the tested sample. Any objections to report issued by AGC should be submitted to AGC within 15days after the issuance of the test report. Further enquiry of validity or verification of the test report should be addressed to AGC by agc@agc-cert.com.



EN 62368-1			
Clause	Requirement – Test	Result - Remark	Verdict
M.3.3	Compliance	No chemical leakage, no liquid spillage, no explosion, no emission fo flame or expulsion of molten metal	P
M.4	Additional safeguards for equipment containing secondary lithium battery		P
M.4.1	General		P
M.4.2	Charging safeguards		P
M.4.2.1	Charging operating limits		P
M.4.2.2a)	Charging voltage, current and temperature	(See appended table M.4)	P
M.4.2.2 b)	Single faults in charging circuitry	(See appended table M.4)	P
M.4.3	Fire Enclosure		N
M.4.4	Endurance of equipment containing a secondary lithium battery		P
M.4.4.2	Preparation		P
M.4.4.3	Drop and charge/discharge function tests		P
	Drop	After Drop test, the open circuit voltage difference: 0.2% in the 24H.	P
	Charge		P
	Discharge		P
M.4.4.4	Charge-discharge cycle test	(See appended table M.4)	P
M.4.4.5	Result of charge-discharge cycle test	No explosion and Emission of flame	P
M.5	Risk of burn due to short circuit during carrying		P
M.5.1	Requirement	No opening	P
M.5.2	Compliance and Test Method (Test of P.2.3)		N
M.6	Prevention of short circuits and protection from other effects of electric current		P
M.6.1	Short circuits		P
M.6.1.1	General requirements	No such explosion or fire likely to result from short circuits.	P
M.6.1.2	Test method to simulate an internal fault		N
M.6.1.3	Compliance (Specify M.6.1.2 or alternative method)		N
M.6.2	Leakage current (mA)		N
M.7	Risk of explosion from lead acid and NiCd batteries		N

Any report having not been signed by authorized approver, or having been altered without authorization, or having not been stamped by the "Dedicated Testing/Inspection Stamp" is deemed to be invalid. Copying or excerpting portion of, or altering the content of the report is not permitted without the written authorization of AGC. The test results presented in the report apply only to the tested sample. Any objections to report issued by AGC should be submitted to AGC within 15days after the issuance of the test report. Further enquiry of validity or verification of the test report should be addressed to AGC by agc@agc-cert.com.



EN 62368-1			
Clause	Requirement – Test	Result - Remark	Verdict
M.7.1	Ventilation preventing explosive gas concentration		N
M.7.2	Compliance and test method		N
M.8	Protection against internal ignition from external spark sources of lead acid batteries		N
M.8.1	General requirements		N
M.8.2	Test method		N
M.8.2.1	General requirements		N
M.8.2.2	Estimation of hypothetical volume V_z (m ³ /s)		—
M.8.2.3	Correction factors		—
M.8.2.4	Calculation of distance d (mm)		—
M.9	Preventing electrolyte spillage		N
M.9.1	Protection from electrolyte spillage		N
M.9.2	Tray for preventing electrolyte spillage		N
M.10	Instructions to prevent reasonably foreseeable misuse (Determination of compliance: inspection, data review; or abnormal testing)		P

N	ELECTROCHEMICAL POTENTIALS		N
	Metal(s) used.....		—

O	MEASUREMENT OF CREEPAGE DISTANCES AND CLEARANCES		N
	Figures O.1 to O.20 of this Annex applied.....		—

P	SAFEGUARDS AGAINST ENTRY OF FOREIGN OBJECTS AND SPILLAGE OF INTERNAL LIQUIDS		P
P.1	General requirements	No opening	P
P.2.2	Safeguards against entry of foreign object		N
	Location and Dimensions (mm)		—
P.2.3	Safeguard against the consequences of entry of foreign object		N
P.2.3.1	Safeguards against the entry of a foreign object		N
	Openings in transportable equipment		N
	Transportable equipment with metalized plastic parts.....		N

Any report having not been signed by authorized approver, or having been altered without authorization, or having not been stamped by the "Dedicated Testing/Inspection Stamp" is deemed to be invalid. Copying or excerpting portion of, or altering the content of the report is not permitted without the written authorization of AGC. The test results presented in the report apply only to the tested sample. Any objections to report issued by AGC should be submitted to AGC within 15 days after the issuance of the test report. Further enquiry of validity or verification of the test report should be addressed to AGC by agc@agc-cert.com.



EN 62368-1			
Clause	Requirement – Test	Result - Remark	Verdict
P.2.3.2	Openings in transportable equipment in relation to metallized parts of a barrier or enclosure (identification of supplementary safeguard)		N
P.3	Safeguards against spillage of internal liquids	No such construction.	N
P.3.1	General requirements		N
P.3.2	Determination of spillage consequences		N
P.3.3	Spillage safeguards		N
P.3.4	Safeguards effectiveness		N
P.4	Metallized coatings and adhesive securing parts	No such construction.	N
P.4.2 a)	Conditioning testing		N
	Tc (°C)		—
	Tr (°C).....		—
	Ta (°C)		—
P.4.2 b)	Abrasion testing		N
P.4.2 c)	Mechanical strength testing.....		N

Q	CIRCUITS INTENDED FOR INTERCONNECTION WITH BUILDING WIRING		N
Q.1	Limited power sources		N
Q.1.1 a)	Inherently limited output		N
Q.1.1 b)	Impedance limited output		N
	- Regulating network limited output under normal operating and simulated single fault condition		N
Q.1.1 c)	Overcurrent protective device limited output		N
Q.1.1 d)	IC current limiter complying with G.9		N
Q.1.2	Compliance and test method		N
Q.2	Test for external circuits – paired conductor cable		N
	Maximum output current (A)		—
	Current limiting method		—

R	LIMITED SHORT CIRCUIT TEST		N
R.1	General requirements	No such consideration.	N
R.2	Determination of the overcurrent protective device and circuit		N

Any report having not been signed by authorized approver, or having been altered without authorization, or having not been stamped by the "Dedicated Testing/Inspection Stamp" is deemed to be invalid. Copying or excerpting portion of, or altering the content of the report is not permitted without the written authorization of AGC. The test results presented in the report apply only to the tested sample. Any objections to report issued by AGC should be submitted to AGC within 15 days after the issuance of the test report. Further enquiry of validity or verification of the test report should be addressed to AGC by agc@agc-cert.com.



EN 62368-1			
Clause	Requirement – Test	Result - Remark	Verdict
R.3	Test method Supply voltage (V) and short-circuit current (A).		N

S	TESTS FOR RESISTANCE TO HEAT AND FIRE		N
S.1	Flammability test for fire enclosures and fire barrier materials of equipment where the steady state power does not exceed 4 000 W		N
	Samples, material.....		—
	Wall thickness (mm).....		—
	Conditioning (°C)		—
	Test flame according to IEC 60695-11-5 with conditions as set out		N
	- Material not consumed completely		N
	- Material extinguishes within 30s		N
	- No burning of layer or wrapping tissue		N
S.2	Flammability test for fire enclosure and fire barrier integrity		N
	Samples, material.....		—
	Wall thickness (mm).....		—
	Conditioning (°C)		—
	Test flame according to IEC 60695-11-5 with conditions as set out		N
	Test specimen does not show any additional hole		N
S.3	Flammability test for the bottom of a fire enclosure		N
	Samples, material.....		—
	Wall thickness (mm).....		—
	Cheesecloth did not ignite		N
S.4	Flammability classification of materials		N
S.5	Flammability test for fire enclosures and fire barrier materials of equipment where the steady state power does not exceed 4 000 W		N
	Samples, material.....		—
	Wall thickness (mm).....		—
	Conditioning (test condition), (°C).....		—

Any report having not been signed by authorized approver, or having been altered without authorization, or having not been stamped by the "Dedicated Testing/Inspection Stamp" is deemed to be invalid. Copying or excerpting portion of, or altering the content of the report is not permitted without the written authorization of AGC. The test results presented in the report apply only to the tested sample. Any objections to report issued by AGC should be submitted to AGC within 15 days after the issuance of the test report. Further enquiry of validity or verification of the test report should be addressed to AGC by agc@agc-cert.com.



EN 62368-1			
Clause	Requirement – Test	Result - Remark	Verdict
	Test flame according to IEC 60695-11-20 with conditions as set out		N
	After every test specimen was not consumed completely		N
	After fifth flame application, flame extinguished within 1 min		N

T	MECHANICAL STRENGTH TESTS		P
T.1	General requirements	See the following details.	P
T.2	Steady force test, 10 N		N
T.3	Steady force test, 30 N		N
T.4	Steady force test, 100 N	(See appended table T.4)	P
T.5	Steady force test, 250 N		N
T.6	Enclosure impact test		N
	Fall test		N
	Swing test		N
T.7	Drop test	(See appended table T.7)	P
T.8	Stress relief test.....	(See appended table T.8)	P
T.9	Impact Test (glass)	No such glass provided within the equipment.	N
T.9.1	General requirements		N
T.9.2	Impact test and compliance		N
	Impact energy (J)		—
	Height (m).....		—
T.10	Glass fragmentation test		N
T.11	Test for telescoping or rod antennas	No such antennas provided within the equipment.	N
	Torque value (Nm)		—

U	MECHANICAL STRENGTH OF CATHODE RAY TUBES (CRT) AND PROTECTION AGAINST THE EFFECTS OF IMPLOSION		N
U.1	General requirements	No CRT provided within the equipment.	N
U.2	Compliance and test method for non-intrinsically protected CRTs		N

Any report having not been signed by authorized approver, or having been altered without authorization, or having not been stamped by the "Dedicated Testing/Inspection Stamp" is deemed to be invalid. Copying or excerpting portion of, or altering the content of the report is not permitted without the written authorization of AGC. The test results presented in the report apply only to the tested sample. Any objections to report issued by AGC should be submitted to AGC within 15 days after the issuance of the test report. Further enquiry of validity or verification of the test report should be addressed to AGC by agc@agc-cert.com.



EN 62368-1			
Clause	Requirement – Test	Result - Remark	Verdict
U.3	Protective Screen :		N

V	DETERMINATION OF ACCESSIBLE PARTS (FINGERS, PROBES AND WEDGES)		P
V.1	Accessible parts of equipment	Following the probes test specified in this annex except Figure V.3., V.4 and V.5 is not suitable.	P
V.2	Accessible part criterion	No live parts can be accessible.	P

Any report having not been signed by authorized approver, or having been altered without authorization, or having not been stamped by the "Dedicated Testing/Inspection Stamp" is deemed to be invalid. Copying or excerpting portion of, or altering the content of the report is not permitted without the written authorization of AGC. The test results presented in the report apply only to the tested sample. Any objections to report issued by AGC should be submitted to AGC within 15days after the issuance of the test report. Further enquiry of validity or verification of the test report should be addressed to AGC by agc@agc-cert.com.



EN 62368-1			
Clause	Requirement – Test	Result – Remark	Verdict
ATTACHMENT TO TEST REPORT IEC 62368-1 EUROPEAN GROUP DIFFERENCES AND NATIONAL DIFFERENCES (Audio/video, information and communication technology equipment Part 1: Safety requirements)			
CENELEC COMMON MODIFICATIONS (EN)			--
1	NOTE Z1		P
4.Z1	Protective devices included as integral parts of the equipment or as parts of the building installation:		N
	a) Included as parts of the equipment		N
	b) For components in series with the mains; by devices in the building installation		N
	c) For pluggable type B or permanently connected; by devices in the building installation		N
5.4.2.3.2.4	Interconnection with external circuit		N
10.2.1	Additional requirements in 10.5.1		N
10.5.1	RS1 compliance measurement conditions		N
10.6.2.1	EN 71-1:2011, 4.20 and methods and distances		N
10.Z1	Non-ionizing radiation from radio frequencies in the range 0 to 300 GHz		N
G.7.1	NOTE Z1		N

ZB	ANNEX ZB, SPECIAL NATIONAL CONDITIONS (EN)		--
4.1.15	Denmark, Finland, Norway and Sweden: Class I pluggable equipment type A marking		N
4.7.3	United Kingdom: Torque test socket-outlet BS 1363, and the plug part BS 1363.		N
5.2.2.2	Denmark: Warning for high touchcurrent		N
5.4.11.1 and Annex G	Finland and Sweden: Separation of the telecommunication network from earth		N
5.5.2.1	Norway: Capacitors rated for the applicable line-to-line voltage (230 V).		N
5.5.6	Finland, Norway and Sweden: Resistors used as basic safeguard or bridging basic insulation comply with G.10.1 and G.10.2.		N
5.6.1	Denmark: Protection for pluggable equipment type A; integral part of the equipment		N
5.6.4.2.1	Ireland and United Kingdom: The protective current rating is taken to be 13 A		N

Any report having not been signed by authorized approver, or having been altered without authorization, or having not been stamped by the "Dedicated Testing/Inspection Stamp" is deemed to be invalid. Copying or excerpting portion of, or altering the content of the report is not permitted without the written authorization of AGC. The test results presented in the report apply only to the tested sample. Any objections to report issued by AGC should be submitted to AGC within 15days after the issuance of the test report. Further enquiry of validity or verification of the test report should be addressed to AGC by agc@agc-cert.com.



EN 62368-1			
Clause	Requirement – Test	Result – Remark	Verdict
5.6.5.1	Ireland and United Kingdom: Conductor sizes of flexible cords to be accepted by terminals for equipment rated 10 A to 13 A		N
5.7.5	Denmark: The installation instruction affixed to the equipment if high protective conductor current		N
5.7.6.1	Norway and Sweden: Television distribution system isolation text in user manual		N
5.7.6.2	Denmark: Warning for high touch current		N
B.3.1 and B.4	Ireland and United Kingdom: Tests conducted using an external miniature circuit breaker or protective devices included as an integral part of the direct plug-in equipment		N
G.4.2	Denmark: Appliances rated ≤ 13 A provided with a plug according to DS 60884-2-D1:2011.		N
	Class I equipment provided with socket-outlets provided with a plug in accordance with standard sheet DK 2-1a or DK 2-5a.		N
	If a single-phase equipment having rated >13 A or poly-phase equipment provided with a supply cord with a plug, plug in accordance with the standard sheets DK 6-1a in DS 60884-2-D1 or EN 60309-2.		N
	Mains socket outlets intended for providing power to Class II apparatus rated 2,5 A in accordance with DS 60884-2-D1:2011 standard sheet DKA 1- 4a.		N
	Other current rating socket outlets in compliance with Standard Sheet DKA 1-3a or DKA 1-1c.		N
	Mains socket-outlets with earth in compliance with DS 60884-2-D1:2011 Standard Sheet DK 1- 3a, DK 1-1c, DK1-1d, DK 1-5a or DK 1-7a		N
G.4.2	United Kingdom: The plug part of direct plug-in equipment assessed to BS 1363		N
G.7.1	United Kingdom: Equipment fitted with a 'standard plug' in accordance with the Plugs and Sockets etc (Safety) Regulations 1994, Statutory Instrument 1994 No. 1768		N
G.7.1	Ireland: Apparatus provided with a plug in accordance with Statutory Instrument 525: 1997, "13 A Plugs and Conversion Adapters for Domestic Use		N
G.7.2	Ireland and United Kingdom: A power supply cord for equipment which is rated over 10 A and up to and including 13 A.		N

ZC	ANNEX ZC, NATIONAL DEVIATIONS (EN)	--
-----------	---	----

Any report having not been signed by authorized approver, or having been altered without authorization, or having not been stamped by the "Dedicated Testing/Inspection Stamp" is deemed to be invalid. Copying or excerpting portion of, or altering the content of the report is not permitted without the written authorization of AGC. The test results presented in the report apply only to the tested sample. Any objections to report issued by AGC should be submitted to AGC within 15 days after the issuance of the test report. Further enquiry of validity or verification of the test report should be addressed to AGC by agc@agc-cert.com.



EN 62368-1			
Clause	Requirement – Test	Result – Remark	Verdict
10.5.2	Germany: Cathode ray tube intended for the display of visual images, authorization or application of type approval and marking.		N

Any report having not been signed by authorized approver, or having been altered without authorization, or having not been stamped by the "Dedicated Testing/Inspection Stamp" is deemed to be invalid. Copying or excerpting portion of, or altering the content of the report is not permitted without the written authorization of AGC. The test results presented in the report apply only to the tested sample. Any objections to report issued by AGC should be submitted to AGC within 15 days after the issuance of the test report. Further enquiry of validity or verification of the test report should be addressed to AGC by agc@agc-cert.com.

Attestation of Global Compliance(Shenzhen)Co., Ltd
Attestation of Global Compliance(Shenzhen)Std & Tech Co., Ltd
Tel: +86-755 2523 4088 E-mail: agc@agc-cert.com Web: http://cn.agc-cert.com/



4.1.2	TABLE: List of critical components					P
Object / part No.	Manufacturer/ trademark	Type / model	Technical data	Standard	Mark(s) of conformity ¹	
Battery	ZHONGSHAN ZHONGWANGDE NEW ENERGY TECHNOLOGY CO., LTD	531926	3.8V, 280mAh Max charge current: 280mA; Max discharge current: 280mA;	IEC 62133:2012	IEC 62133 Report	
DC Motor	CHONGQING LINLONG ELECTRONIC CO., LTD	C0827L-066332017-1401	DC3.0V, 85mA, 60°C	EN 62368-1:2014+A11:2017	Tested with appliance	
PCB	Interchangeable	Interchangeable	V-0, 130°C	UL94, UL796	UL	
Plastic Enclosure	SABIC INNOVATIVE PLASTICS B V	DMX1435 (GG)	Min. 1.0mm, HB, 80°C	UL94	UL E45329	
Supplementary information:--						

4.8.4, 4.8.5	TABLE: Lithium coin/button cell batteries mechanical tests			N
(The following mechanical tests are conducted in the sequence noted.)				
4.8.4.2	TABLE: Stress relief test			—
Part	Material	Oven Temperature (°C)	Comments	
4.8.4.3	TABLE: Battery replacement test			—
Battery part no. :				
Battery Installation/withdrawal	Battery Installation/Removal Cycle	Comments		
	1			
	2			
	3			
	4			
	5			
	6			
	8			
	9			
	10			
4.8.4.4	TABLE: Drop test			—
Impact Area	Drop Distance	Drop No.	Observations	
		1		
		2		

Any report having not been signed by authorized approver, or having been altered without authorization, or having not been stamped by the "Dedicated Testing/Inspection Stamp" is deemed to be invalid. Copying or excerpting portion of, or altering the content of the report is not permitted without the written authorization of AGC. The test results presented in the report apply only to the tested sample. Any objections to report issued by AGC should be submitted to AGC within 15days after the issuance of the test report. Further enquiry of validity or verification of the test report should be addressed to AGC by agc@agc-cert.com.



4.8.4, 4.8.5	TABLE: Lithium coin/button cell batteries mechanical tests			N
(The following mechanical tests are conducted in the sequence noted.)				
4.8.4.5	TABLE: Impact			—
Impacts per surface	Surface tested	Impact energy (Nm)	Comments	
4.8.4.6	TABLE: Crush test			—
Test position	Surface tested	Crushing Force (N)	Duration force applied (s)	
Supplementary information:				

4.8.5	TABLE: Lithium coin/button cell batteries mechanical test result			N
Test position	Surface tested	Force (N)	Duration force applied (s)	
Supplementary information:				

5.2	Table: Classification of electrical energy sources					P	
5.2.2.2 – Steady State Voltage and Current conditions							
No.	Supply Voltage	Location (e.g. circuit designation)	Test conditions	Parameters			ES Class
				U (Vrms or Vpk)	I (Apk or Arms)	Hz	
1	5.0V	Internal circuit	Normal	5.10	--	DC	ES1
			Abnormal	--	--	--	
			Single fault – SC/OC: --	--	--	--	
2	Fully charged battery	Battery pack output	Normal	4.35V	--	DC	ES1
			Abnormal	--	--	--	
			Single fault – SC/OC: --	--	--	--	

5.2.2.3 – Capacitance Limits						
No.	Supply Voltage	Location (e.g. circuit designation)	Test conditions	Parameters		ES Class
				Capacitance, nF	Upk (V)	
--	--	--	Normal	--	--	--

Any report having not been signed by authorized approver, or having been altered without authorization, or having not been stamped by the "Dedicated Testing/Inspection Stamp" is deemed to be invalid. Copying or excerpting portion of, or altering the content of the report is not permitted without the written authorization of AGC. The test results presented in the report apply only to the tested sample. Any objections to report issued by AGC should be submitted to AGC within 15 days after the issuance of the test report. Further enquiry of validity or verification of the test report should be addressed to AGC by agc@agc-cert.com.



			Abnormal	--	--
			Single fault – SC/OC	--	--

5.2.2.4 – Single Pulses

No.	Supply Voltage	Location (e.g. circuit designation)	Test conditions	Parameters			ES Class
				Duration (ms)	Upk (V)	lpk (mA)	
--	--	--	Normal	--	--	--	--
			Abnormal	--	--	--	
			Single fault – SC/OC	--	--	--	

5.2.2.5 – Repetitive Pulses

No.	Supply Voltage	Location (e.g. circuit designation)	Test conditions	Parameters			ES Class
				Off time (ms)	Upk (V)	lpk (mA)	
--	--	--	Normal	--	--	--	--
			Abnormal	--	--	--	
			Single fault – SC/OC	--	--	--	

Test Conditions:

- Normal –
- Abnormal –

Supplementary information: SC=Short Circuit, OC=Short Circuit

5.4.1.4, 6.3.2, 9.0, B.2.6	TABLE: Temperature measurements			P
Supply voltage (V)	a) 5V, charging condition b) powered by fully charged internal battery			—
Ambient T _{min} (°C)	--	--	--	—
Ambient T _{max} (°C)	--	--	--	—
T _{ma} (°C)	40	40	40	—
Maximum measured temperature T of part/at:	T (°C)			Allowed T _{max} (°C)
Test condition No.:	a)	b)		--
Battery surface	48.9	46.5		Ref.
Internal wire from battery	49.4	47.1		70
PCB near U7	52.5	49.8		130
Motor	49.5	47.4		Ref.
Plastic enclosure inside near PCB	48.7	46.2		Ref.
Ambient	40.0	40.0		--

Any report having not been signed by authorized approver, or having been altered without authorization, or having not been stamped by the "Dedicated Testing/Inspection Stamp" is deemed to be invalid. Copying or excerpting portion of, or altering the content of the report is not permitted without the written authorization of AGC. The test results presented in the report apply only to the tested sample. Any objections to report issued by AGC should be submitted to AGC within 15days after the issuance of the test report. Further enquiry of validity or verification of the test report should be addressed to AGC by agc@agc-cert.com.

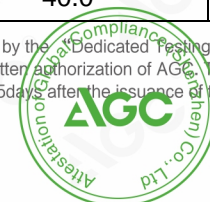

For accessible part							
Panel		28.8		26.3		48	
Plastic enclosure outside near PCB		31.2		29.6		48	
Ambient		25.0		25.0		--	
Supplementary information: *) Temperature limits for winding include less 10K for thermocouple measurement method.							
Temperature T of winding:	t ₁ (°C)	R ₁ (Ω)	t ₂ (°C)	R ₂ (Ω)	T (°C)	Allowed T _{max} (°C)	Insulation class
--	--	--	--	--	--	--	--
--	--	--	--	--	--	--	--
Supplementary information: Note 1: T _{ma} should be considered as directed by applicable requirement Note 2: T _{ma} is not included in assessment of Touch Temperatures (Clause 9)							

5.4.1.10.3	TABLE: Ball pressure test of thermoplastics			N
Allowed impression diameter (mm): ≤ 2 mm				—
Object/Part No./Material	Manufacturer/trademark	Test temperature (°C)	Impression diameter (mm)	
--	--	--	--	
Supplementary information:				

5.4.2.2, 5.4.2.4 and 5.4.3	TABLE: Minimum Clearances/Creepage distance						N
Clearance (cl) and creepage distance (cr) at/of/between:	Up (V)	U r.m.s. (V)	Frequency (kHz) ¹	Required cl (mm)	cl (mm) ²	Required ³ cr (mm)	cr (mm)
--	--	--	--	--	--	--	--
Supplementary information: Note 1: Only for frequency above 30 kHz Note 2: See table 5.4.2.4 if this is based on electric strength test Note 3: Provide Material Group							

5.4.2.3	TABLE: Minimum Clearances distances using required withstand voltage			N
Overtoltage Category (OV):				--
Pollution Degree:				--
Clearance distanced between:	Required withstand voltage	Required cl (mm)	Measured cl (mm)	
--	--	--	--	
Supplementary information:				

Any report having not been signed by authorized approver, or having been altered without authorization, or having not been stamped by the "Dedicated Testing/Inspection Stamp" is deemed to be invalid. Copying or excerpting portion of, or altering the content of the report is not permitted without the written authorization of AGC. The test results presented in the report apply only to the tested sample. Any objections to report issued by AGC should be submitted to AGC within 15 days after the issuance of the test report. Further enquiry of validity or verification of the test report should be addressed to AGC by agc@agc-cert.com.



5.4.2.4	TABLE: Clearances based on electric strength test			N
Test voltage applied between:	Required cl (mm)	Test voltage (kV) peak/ r.m.s. / d.c-	Breakdown Yes / No	
--	--	--	--	
Supplementary information:				

5.4.4.2, 5.4.4.5 c) 5.4.4.9	TABLE: Distance through insulation measurements					N
Distance through insulation di at/of:	Peak voltage (V)	Frequency (kHz)	Material	Required DTI (mm)	DTI (mm)	
--	--	--	--	--	--	
Supplementary information:						

5.4.9	TABLE: Electric strength tests			N
Test voltage applied between:	Voltage shape (AC, DC)	Test voltage (V)	Breakdown Yes / No	
Functional:				
--	--	--	--	
Basic/supplementary:				
--	--	--	--	
Reinforced:				
--	--	--	--	
Routine Tests:				
--	--	--	--	
Supplementary information:				

5.5.2.2	TABLE: Stored discharge on capacitors					N
Supply Voltage (V), Hz	Test Location	Operating Condition (N, S)	Switch position On or off	Measured Voltage (after 2 seconds)	ES Classification	
--	--	--	--	--	--	
Supplementary information:						
X-capacitors installed for testing are:						
<input type="checkbox"/> bleeding resistor rating:						
<input type="checkbox"/> ICX:						
Notes:						
A. Test Location:						
Phase to Neutral; Phase to Phase; Phase to Earth; and/or Neutral to Earth						
B. Operating condition abbreviations:						
N – Normal operating condition (e.g., normal operation, or open fuse); S –Single fault condition						

Any report having not been signed by authorized approver, or having been altered without authorization, or having not been stamped by the "Dedicated Testing/Inspection Stamp" is deemed to be invalid. Copying or excerpting portion of, or altering the content of the report is not permitted without the written authorization of AGC. The test results presented in the report apply only to the tested sample. Any objections to report issued by AGC should be submitted to AGC within 15 days after the issuance of the test report. Further enquiry of validity or verification of the test report should be addressed to AGC by agc@agc-cert.com.



5.6.6.2 TABLE: Resistance of protective conductors and terminations				N
Accessible part	Test current (A)	Duration (min)	Voltage drop (V)	Resistance (Ω)
--	--	--	--	--
--	--	--	--	--
--	--	--	--	--

Supplementary information:

5.7.2.2, 5.7.4 TABLE: Earthed accessible conductive part			N
Supply voltage.....:			—
Location	Test conditions specified in 6.1 of IEC 60990 or Fault Condition No in IEC 60990 clause 6.2.2.1 through 6.2.2.8, except for 6.2.2.7		Touch current (mA)
--	1		--
--	2*		--
--	3		--
--	4		--
--	5		--
--	6		--
--	7		--

Supplementary Information:
Notes:
[1] Supply voltage is the anticipated maximum Touch Voltage
[2] Earthed neutral conductor [Voltage differences less than 1% or more]
[3] Specify method used for measurement as described in IEC 60990 sub-clause 4.3
[4] IEC60990, sub-clause 6.2.2.7, Fault 7 not applicable.
[5] (*) IEC60990, sub-clause 6.2.2.2 is not applicable if switch or disconnect device (e.g., appliance coupler) provided.

6.2.2 Table: Electrical power sources (PS) measurements for classification					P
Source	Description	Measurement	Max Power after 3 s	Max Power after 5 s ^(*)	PS Classification
5Vdc	Internal circuit	Power (W) :	--	--	PS2 (by declared)
		V _A (V) :	--	--	
		I _A (A) :	--	--	
4.35Vdc	Battery pack output	Power (W) :	6.36	--	PS1
		V _A (V) :	2.89	--	
		I _A (A) :	2.20	--	

Any report having not been signed by authorized approver, or having been altered without authorization, or having not been stamped by the "Dedicated Testing/Inspection Stamp" is deemed to be invalid. Copying or excerpting portion of, or altering the content of the report is not permitted without the written authorization of AGC. The test results presented in the report apply only to the tested sample. Any objections to report issued by AGC should be submitted to AGC within 15days after the issuance of the test report. Further enquiry of validity or verification of the test report should be addressed to AGC by agc@agc-cert.com.

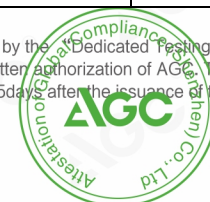

4.35Vdc	Battery cell output	Power (W) :	10.12	--	PS1
		V _A (V) :	3.37	--	
		I _A (A) :	3.00	--	

Supplementary Information:

(*) Measurement taken only when limits at 3 seconds exceed PS1 limits

6.2.3.1	Table: Determination of Potential Ignition Sources (Arcing PIS)				N
	Location	Open circuit voltage After 3 s (V _p)	Measured r.m.s current (I _{rms})	Calculated value (V _p x I _{rms})	Arcing PIS? Yes / No
	--	--	--	--	--

Supplementary information:

An Arcing PIS requires a minimum of 50 V (peak) a.c. or d.c. An Arcing PIS is established when the product of the open circuit voltage (V_p) and normal operating condition rms current (I_{rms}) is greater than 15.

6.2.3.2	Table: Determination of Potential Ignition Sources (Resistive PIS)				N	
	Circuit Location (x-y)	Operating Condition (Normal / Describe Single Fault)	Measured wattage or VA During first 30 s (W / VA)	Measured wattage or VA After 30 s (W / VA)	Protective Circuit, Regulator, or PTC Operated? Yes / No (Comment)	Resistive PIS? Yes/No
	--	--	--	--	--	--

Supplementary Information:

A combination of voltmeter, VA and ammeter IA may be used instead of a wattmeter.

If a separate voltmeter and ammeter are used, the product of (VA x IA) is used to determine Resistive PIS classification.

A Resistive PIS: (a) dissipates more than 15 W, measured after 30 s of normal operation, or (b) under single fault conditions has either a power exceeding 100 W measured immediately after the introduction of the fault if electronic circuits, regulators or PTC devices are used, or has an available power exceeding 15 W measured 30 s after introduction of the fault.

8.5.5	TABLE: High Pressure Lamp		N
	Description	Values	Energy Source Classification
	Lamp type.....:		—
	Manufacturer		—
	Cat no.:		—
	Pressure (cold) (MPa)		MS_
	Pressure (operating) (MPa)		MS_
	Operating time (minutes)		—
	Explosion method.....:		—
	Max particle length escaping enclosure (mm)...		MS_

Any report having not been signed by authorized approver, or having been altered without authorization, or having not been stamped by the "Dedicated Testing/Inspection Stamp" is deemed to be invalid. Copying or excerpting portion of, or altering the content of the report is not permitted without the written authorization of AGC. The test results presented in the report apply only to the tested sample. Any objections to report issued by AGC should be submitted to AGC within 15 days after the issuance of the test report. Further enquiry of validity or verification of the test report should be addressed to AGC by agc@agc-cert.com.



Max particle length beyond 1 m (mm)	MS_
Overall result	
Supplementary information:	

B.2.5		TABLE: Input test						P
U (V)	I (A)	I rated (A)	P (W)	P rated (W)	Fuse No	I fuse (A)	Condition/status	
4.35	0.041	--	0.178	---	--	--	Normal operation: supplied by full charged battery.	
5.0	0.104	0.5	0.520	--	--	--	Normal operation: Supplied by approved AC Adapter with full discharged battery	
Supplementary information:								

B.3		TABLE: Abnormal operating condition tests						N
Ambient temperature (°C)		--						—
Power source for EUT: Manufacturer, model/type, output rating :		--						—
Component No.	Fault Condition	Supply voltage, (V)	Test time (h)	Fuse no.	Fuse current, (A)	T-couple	Temp. (°C)	Observation
--	--	--	--	--	--	--	--	--
Supplementary information:								

B.4		TABLE: Fault condition tests						P
Ambient temperature (°C)		23.0-26.0						—
Power source for EUT: Manufacturer, model/type, output rating . :		--						—
Component No.	Fault Condition	Supply voltage, (V)	Test time (ms)	Fuse no.	Fuse current, (A)	T-couple	Temp. (°C)	Observation
The EUT was supplied by fully charged battery								
Battery B+ and B-	S-C	4.35	30min	--	--	--	--	No fire, no explosion
Battery B- and P-	S-C	4.35	3h	--	--	--	--	Unit working normally. No damaged, no hazards.
P+ and P-	S-C	4.35	10min	--	--	--	--	Unit shutdown at last, no damage and hazards.

Any report having not been signed by authorized approver, or having been altered without authorization, or having not been stamped by the "Dedicated Testing/Inspection Stamp" is deemed to be invalid. Copying or excerpting portion of, or altering the content of the report is not permitted without the written authorization of AGC. The test results presented in the report apply only to the tested sample. Any objections to report issued by AGC should be submitted to AGC within 15days after the issuance of the test report. Further enquiry of validity or verification of the test report should be addressed to AGC by agc@agc-cert.com.



U4, Pin (1-6)	S-C	4.35	3h	--	--	Type J	PCB near U7: 39.5°C Battery: 34.2°C Ambient: 23.4°C	Unit working normally. No damaged, no hazards. Battery current: 194mA
The EUT was supplied by fully discharged battery								
U3, Pin (1-8)	S-C	5V	30min	--	--	--	--	Unit working normally. No damaged, no hazards. Battery current: 53mA
Battery B- and P-	S-C	5V	7h	--	--	--	--	Unit working normally. No damaged, no hazards.
Motor	Locked	3.0V	7h	--	--	Type J	Motor: 41.4°C Ambient: 23.6°C	No hazards, no damage
Supplementary information:								

Annex M	TABLE: Batteries								P
The tests of Annex M are applicable only when appropriate battery data is not available									--
Is it possible to install the battery in a reverse polarity position?							--	--	
	Non-rechargeable batteries			Rechargeable batteries					
	Discharging		Un-intentional charging	Charging		Discharging		Reversed charging	
	Meas. current	Manuf. Specs.		Meas. current	Manuf. Specs.	Meas. current	Manuf. Specs.	Meas. current	Manuf. Specs.
Max. current during normal condition	--	--	--	102mA	280mA	41mA	280mA	--	--
Max. current during fault condition	--	--	--	102mA	280mA	194mA	280mA	--	--
Test results:									Verdict
- Chemical leaks							No leaks		P
- Explosion of the battery							No explosion		P
- Emission of flame or expulsion of molten metal							No emission		P
- Electric strength tests of equipment after completion of tests							--		N
Supplementary information:									

Any report having not been signed by authorized approver, or having been altered without authorization, or having not been stamped by the "Dedicated Testing/Inspection Stamp" is deemed to be invalid. Copying or excerpting portion of, or altering the content of the report is not permitted without the written authorization of AGC. The test results presented in the report apply only to the tested sample. Any objections to report issued by AGC should be submitted to AGC within 15 days after the issuance of the test report. Further enquiry of validity or verification of the test report should be addressed to AGC by agc@agc-cert.com.



Annex M.4 Table: Additional safeguards for equipment containing secondary lithium batteries					P
Battery/Cell No.	Test conditions	Measurements			Observation
		U(V)	I (A)	Temp (°C)	
1	Normal	4.34	0.102	Battery surface: 32.4 Ambient: 23.5	No hazards
1	Abnormal	4.34	0.102	Battery surface: 32.4 Ambient: 23.5	No hazards
1	Single fault –SC/OC	4.35	0.102	Battery surface: 32.9 Ambient: 23.2	No hazards

Supplementary Information: see table Annex B.4 for detail

Battery identification	Charging at T _{lowest} (°C)	Observation	Charging at T _{highest} (°C)	Observation
Li-ion	0	Charging current: 95mA	45	Charging current: 0

Supplementary Information:

Annex Q.1 TABLE: Circuits intended for interconnection with building wiring (LPS)						N
Note: Measured UOC (V) with all load circuits disconnected:						
Output Circuit	Components	U _{oc} (V)	I _{sc} (A)		S (VA)	
			Meas.	Limit	Meas.	Limit
--	--	--	--	--	--	--
--	--	--	--	--	--	--

Supplementary Information:
S-C=Short circuit, O-C=Open circuit

T.2, T.3, T.4, T.5 TABLE: Steady force test					P
Part/Location	Material	Thickness (mm)	Force(N)	Test Duration (sec)	Observation
Top enclosure	Plastic	Min. 1.0	100	5	No damaged
Side enclosure	Plastic	Min. 1.0	100	5	No damaged
Bottom enclosure	Plastic	Min. 1.0	100	5	No damaged

Supplementary information:

T.6, T.9 TABLE: Impact tests				N
Part/Location	Material	Thickness (mm)	Vertical distance (mm)	Observation
--	--	--	--	--

Supplementary information:

Any report having not been signed by authorized approver, or having been altered without authorization, or having not been stamped by the "Dedicated Testing/Inspection Stamp" is deemed to be invalid. Copying or excerpting portion of, or altering the content of the report is not permitted without the written authorization of AGC. The test results presented in the report apply only to the tested sample. Any objections to report issued by AGC should be submitted to AGC within 15 days after the issuance of the test report. Further enquiry of validity or verification of the test report should be addressed to AGC by agc@agc-cert.com.



T.7	TABLE: Drop tests				P
Part/Location	Material	Thickness (mm)	Drop Height (mm)	Observation	
Top enclosure	Plastic	Min. 1.0	1000	No damaged	
Side enclosure	Plastic	Min. 1.0	1000	No damaged	
Bottom enclosure	Plastic	Min. 1.0	1000	No damaged	
Supplementary information:					

T.8	TABLE: Stress relief test				P
Part/Location	Material	Thickness (mm)	Oven Temperature (°C)	Duration (h)	Observation
Completed sample	Plastic enclosure (for all sources)	Min. 1.0	70	7	No damaged, no hazards.
Supplementary information: For details refer to appended table 4.1.2.					

Any report having not been signed by authorized approver, or having been altered without authorization, or having not been stamped by the "Dedicated Testing/Inspection Stamp" is deemed to be invalid. Copying or excerpting portion of, or altering the content of the report is not permitted without the written authorization of AGC. The test results presented in the report apply only to the tested sample. Any objections to report issued by AGC should be submitted to AGC within 15 days after the issuance of the test report. Further enquiry of validity or verification of the test report should be addressed to AGC by agc@agc-cert.com.



Attachment A
Photos of product



Fig.1 – overview



Fig.2 – overview

Any report having not been signed by authorized approver, or having been altered without authorization, or having not been stamped by the "Dedicated Testing/Inspection Stamp" is deemed to be invalid. Copying or excerpting portion of, or altering the content of the report is not permitted without the written authorization of AGC. The test results presented in the report apply only to the tested sample. Any objections to report issued by AGC should be submitted to AGC within 15 days after the issuance of the test report. Further enquiry of validity or verification of the test report should be addressed to AGC by agc@agc-cert.com.

Attestation of Global Compliance(Shenzhen)Co., Ltd
Attestation of Global Compliance(Shenzhen)Std & Tech Co., Ltd
Tel: +86-755 2523 4088 E-mail: agc@agc-cert.com Web: <http://cn.agc-cert.com/>



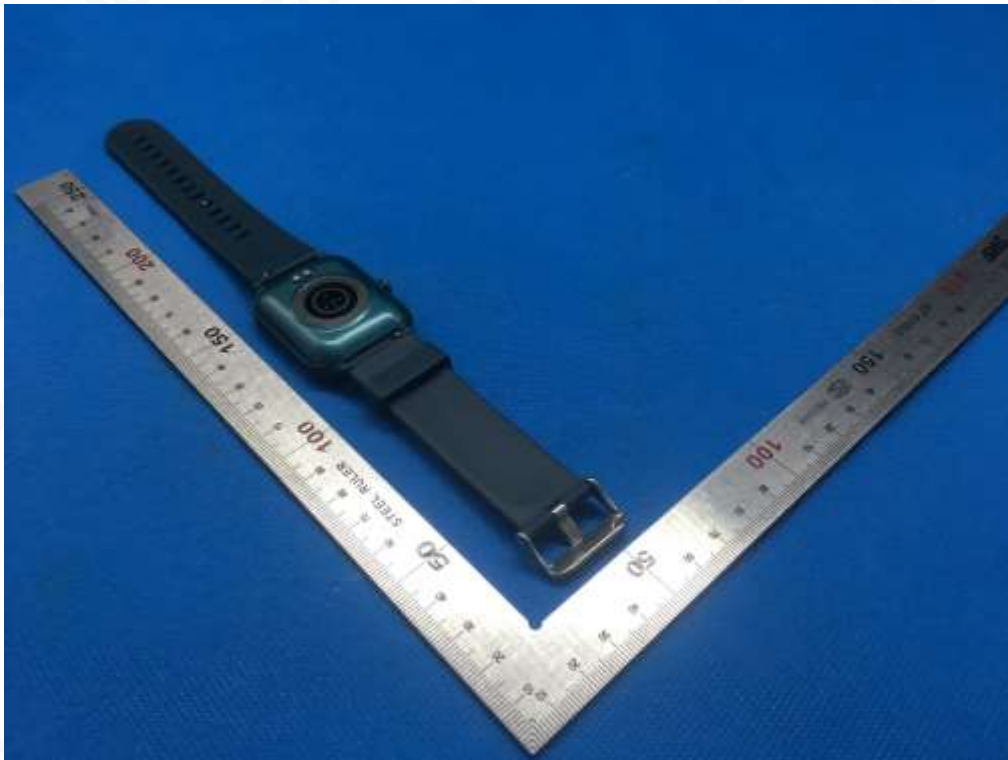

Fig.3 – overview



Fig.4 – connector view

Any report having not been signed by authorized approver, or having been altered without authorization, or having not been stamped by the "Dedicated Testing/Inspection Stamp" is deemed to be invalid. Copying or excerpting portion of, or altering the content of the report is not permitted without the written authorization of AGC. The test results presented in the report apply only to the tested sample. Any objections to report issued by AGC should be submitted to AGC within 15days after the issuance of the test report. Further enquiry of validity or verification of the test report should be addressed to AGC by agc@agc-cert.com.

Attestation of Global Compliance(Shenzhen)Co., Ltd
Attestation of Global Compliance(Shenzhen)Std & Tech Co., Ltd
Tel: +86-755 2523 4088 E-mail: agc@agc-cert.com Web: <http://cn.agc-cert.com/>





Fig.5 – open view



Fig.6 – partview

Any report having not been signed by authorized approver, or having been altered without authorization, or having not been stamped by the "Dedicated Testing/Inspection Stamp" is deemed to be invalid. Copying or excerpting portion of, or altering the content of the report is not permitted without the written authorization of AGC. The test results presented in the report apply only to the tested sample. Any objections to report issued by AGC should be submitted to AGC within 15days after the issuance of the test report. Further enquiry of validity or verification of the test report should be addressed to AGC by agc@agc-cert.com.

Attestation of Global Compliance(Shenzhen)Co., Ltd
Attestation of Global Compliance(Shenzhen)Std & Tech Co., Ltd
Tel: +86-755 2523 4088 E-mail: agc@agc-cert.com Web: http://cn.agc-cert.com/



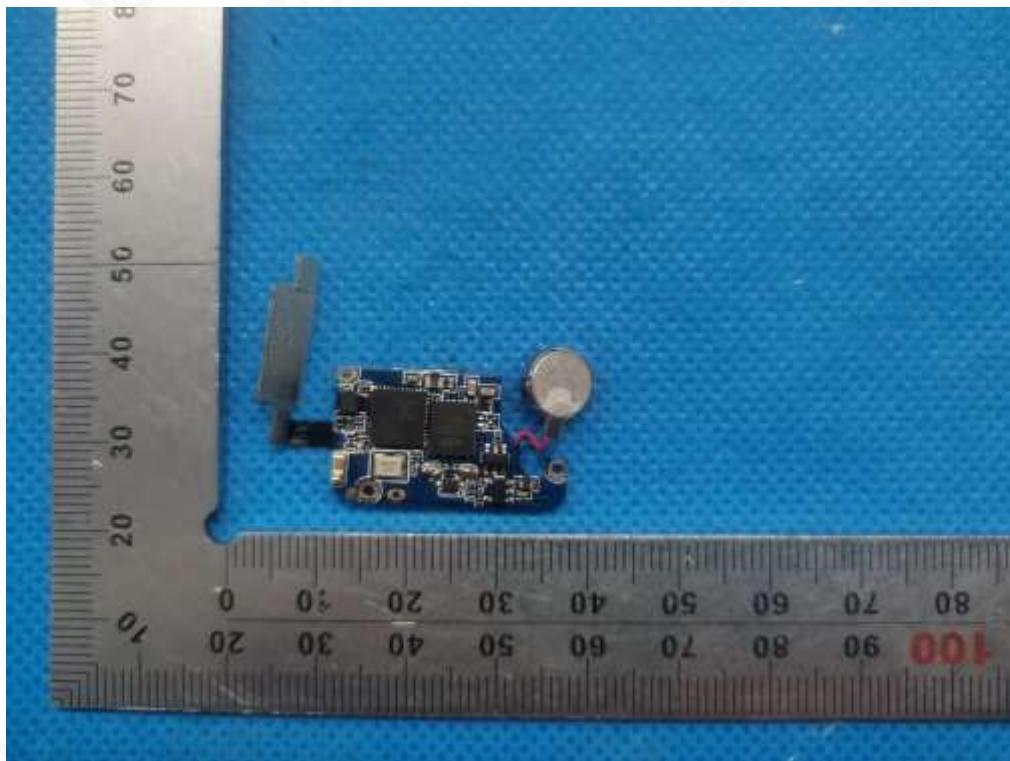

Fig.7 – partview

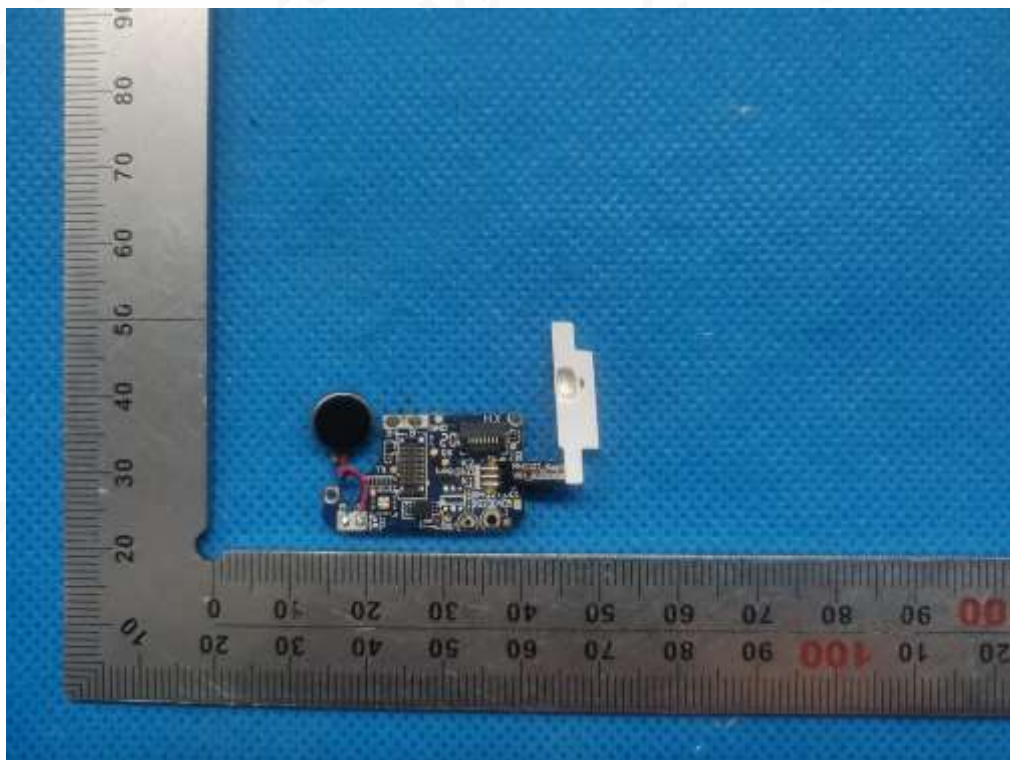

Fig.8 – partview

Any report having not been signed by authorized approver, or having been altered without authorization, or having not been stamped by the "Dedicated Testing/Inspection Stamp" is deemed to be invalid. Copying or excerpting portion of, or altering the content of the report is not permitted without the written authorization of AGC. The test results presented in the report apply only to the tested sample. Any objections to report issued by AGC should be submitted to AGC within 15days after the issuance of the test report. Further enquiry of validity or verification of the test report should be addressed to AGC by agc@agc-cert.com.

Attestation of Global Compliance(Shenzhen)Co., Ltd
Attestation of Global Compliance(Shenzhen)Std & Tech Co., Ltd
Tel: +86-755 2523 4088 E-mail: agc@agc-cert.com Web: <http://cn.agc-cert.com/>



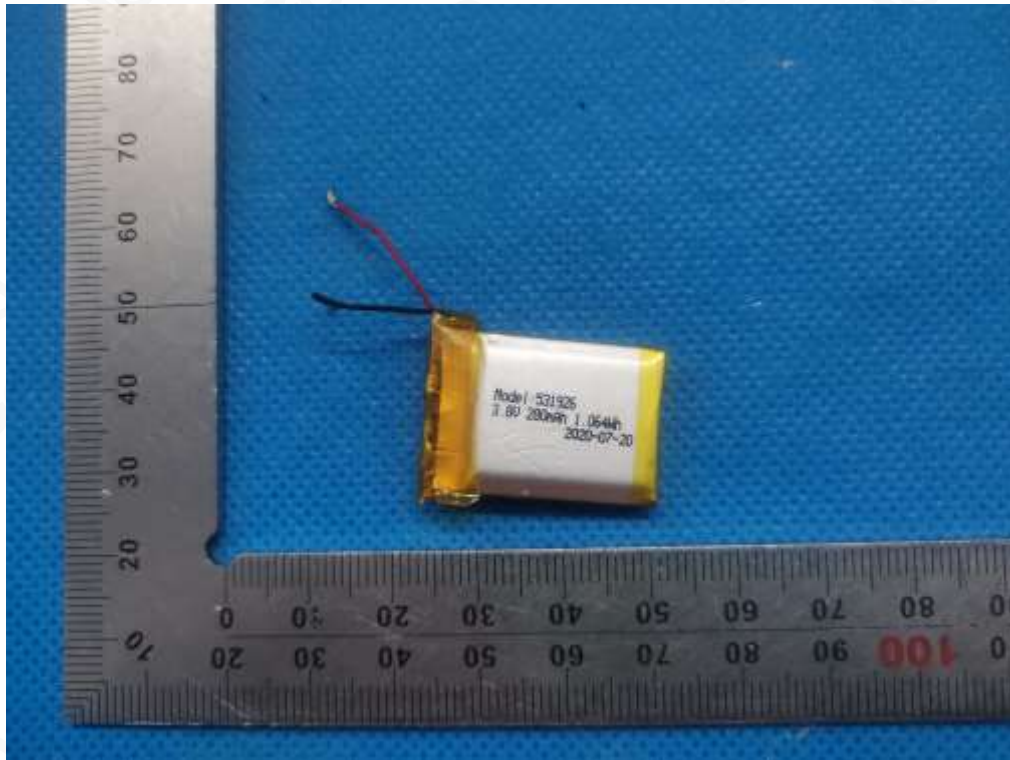

Fig.9 – battery view

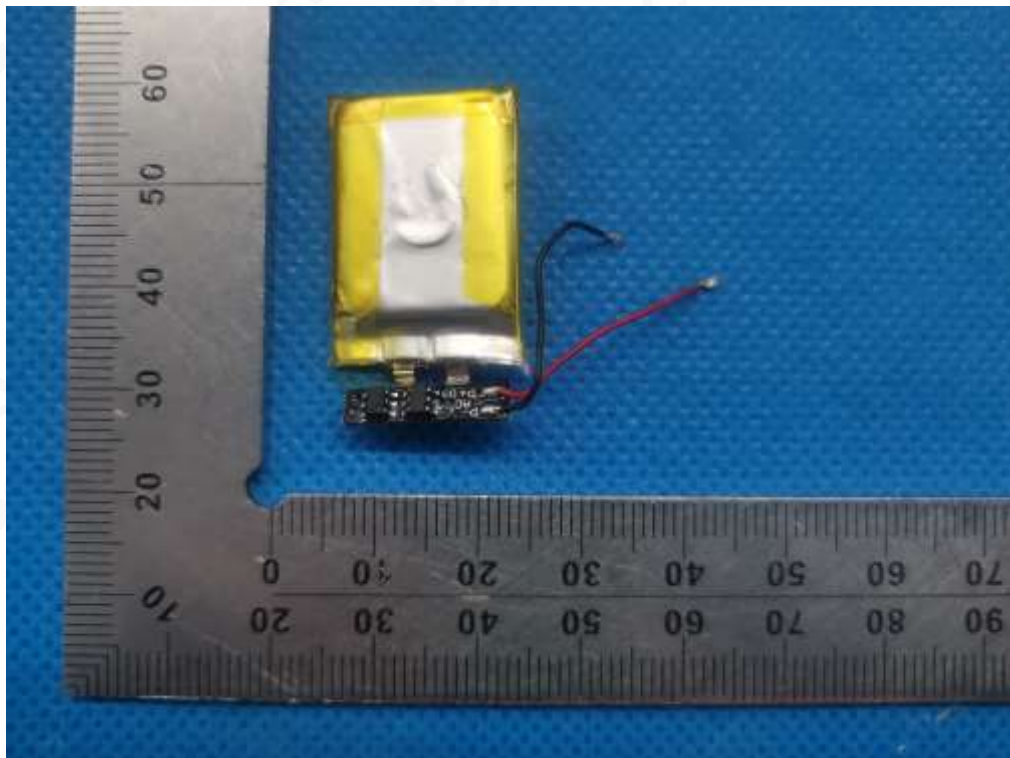

Fig.10 – battery view

Any report having not been signed by authorized approver, or having been altered without authorization, or having not been stamped by the "Dedicated Testing/Inspection Stamp" is deemed to be invalid. Copying or excerpting portion of, or altering the content of the report is not permitted without the written authorization of AGC. The test results presented in the report apply only to the tested sample. Any objections to report issued by AGC should be submitted to AGC within 15 days after the issuance of the test report. Further enquiry of validity or verification of the test report should be addressed to AGC by agc@agc-cert.com.

Attestation of Global Compliance(Shenzhen)Co., Ltd
Attestation of Global Compliance(Shenzhen)Std & Tech Co., Ltd
Tel: +86-755 2523 4088 E-mail: agc@agc-cert.com Web: <http://cn.agc-cert.com/>



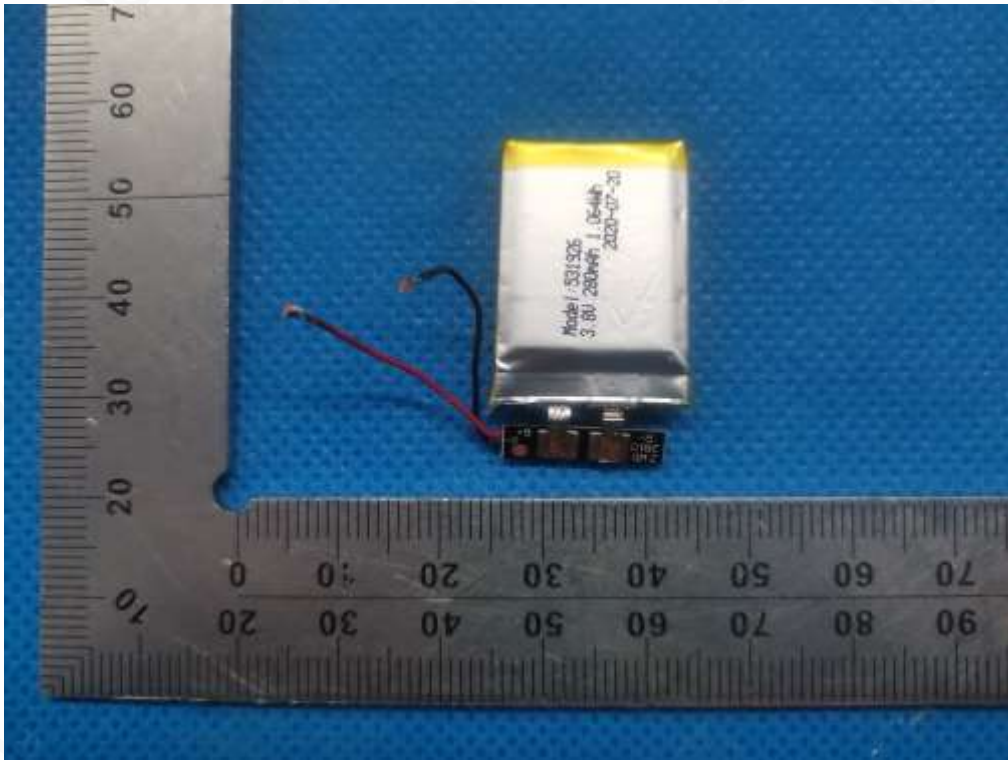

Fig.11 – battery view

-----END OF REPORT-----

Any report having not been signed by authorized approver, or having been altered without authorization, or having not been stamped by the "Dedicated Testing/Inspection Stamp" is deemed to be invalid. Copying or excerpting portion of, or altering the content of the report is not permitted without the written authorization of AGC. The test results presented in the report apply only to the tested sample. Any objections to report issued by AGC should be submitted to AGC within 15 days after the issuance of the test report. Further enquiry of validity or verification of the test report should be addressed to AGC by agc@agc-cert.com.

Attestation of Global Compliance(Shenzhen)Co., Ltd
Attestation of Global Compliance(Shenzhen)Std & Tech Co., Ltd
Tel: +86-755 2523 4088 E-mail: agc@agc-cert.com Web: <http://cn.agc-cert.com/>





Conditions of Issuance of Test Reports

1. All samples and goods are accepted by the Attestation of Global Compliance (Shenzhen) Co., Ltd (the “Company”) solely for testing and reporting in accordance with the following terms and conditions. The company provides its services on the basis that such terms and conditions constitute express agreement between the company and any person, firm or company requesting its services (the “Clients”).
2. Any report issued by Company as a result of this application for testing services (the “Report”) shall be issued in confidence to the Clients and the Report will be strictly treated as such by the Company. It may not be reproduced either in its entirety or in part and it may not be used for advertising or other unauthorized purposes without the written consent of the Company. The Clients to whom the Report is issued may, however, show or send it, or a certified copy thereof prepared by the Company to its customer, supplier or other persons directly concerned. The Company will not, without the consent of the Clients, enter into any discussion or correspondence with any third party concerning the contents of the Report, unless required by the relevant governmental authorities, laws or court orders.
3. The Company shall not be called or be liable to be called to give evidence or testimony on the Report in a court of law without its prior written consent, unless required by the relevant governmental authorities, laws or court orders.
4. The non-CMA report issued by AGC is only permitted to be used by the client as internal reference use and shall not be used for public demonstration purpose.
5. In the event of the improper use of the report as determined by the Company, the Company reserves the right to withdraw it, and to adopt any other additional remedies which may be appropriate.
6. Samples submitted for testing are accepted on the understanding that the Report issued cannot form the basis of, or be the instrument for, any legal action against the Company.
7. The Company will not be liable for or accept responsibility for any loss or damage however arising from the use of information contained in any of its Reports or in any communication whatsoever about its said tests or investigations.
8. Clients wishing to use the Report in court proceedings or arbitration shall inform the Company to that effect prior to submitting the sample for testing.
9. The Company is not responsible for recalling the electronic version of the original report when any revision is made to them. The Client assumes the responsibility to providing the revised version to any interested party who uses them.
10. Subject to the variable length of retention time for test data and report stored hereinto as otherwise specifically required by individual accreditation authorities, the Company will only keep the supporting test data and information of the test report for a period of six years. The data and information will be disposed of after the aforementioned retention period has elapsed. Under no circumstances shall we provide any data and information which has been disposed of after retention period. Under no circumstances shall we be liable for damage of any kind, including (but not limited to) compensatory damages, lost profits, lost data, or any form of special, incidental, indirect, consequential or punitive damages of any kind, whether based on breach of contract of warranty, tort (including negligence), product liability or otherwise, even if we are informed in advance of the possibility of such damages.

Any report having not been signed by authorized approver, or having been altered without authorization, or having not been stamped by the “Dedicated Testing/Inspection Stamp” is deemed to be invalid. Copying or excerpting portion of, or altering the content of the report is not permitted without the written authorization of AGC. The test results presented in the report apply only to the tested sample. Any objections to report issued by AGC should be submitted to AGC within 15 days after the issuance of the test report. Further enquiry of validity or verification of the test report should be addressed to AGC by agc@agc-cert.com.

