

EMC Test Report

Client Information:

Applicant: DOKE COMMUNICATION (HK) LIMITED
Applicant add.: RM 1902 EASEY COMM BLDG 253-261 HENNESSY ROAD WANCHAI HK CHINA

Product Information:

Product Name: Tablet
Model No.: Active 6
Serial Model: N/A
Brand Name: Blackview
Standards: ETSI EN 301 489-1 V2.2.3 (2019-11))
ETSI EN 301 489-17 V3.2.4 (2020-09)
ETSI EN 301 489-19 V2.1.1(2019-04)
ETSI EN 301 489-52 V1.2.1 (2021-11)
EN 55032:2015+A11:2020; EN 55035:2017+A1:2020
EN IEC 61000-3-2:2019+A1:2021; EN 61000-3-3:2013+A1: 2019

Prepared By:

Dongguan Yaxu (AiT) Technology Limited

Add. : No.22, Jinqianling Third Street, Jitigang, Huangjiang,
Dongguan, Guangdong, China

Date of Receipt: 2023.07.13 Date of Test: 2023.07.13~2023.08.07
Date of Issue: 2023.08.08 Test Result: Pass

This device has been tested and found to comply with the stated standard(s), which is (are) required by the council directive of 2014/53/EU and indicated in the test report and are applicable only to the tested sample identified in the report.

Note: This report shall not be reproduced except in full, without the written approval of Dongguan Yaxu (AiT) Technology Limited, this document may be altered or revised by Dongguan Yaxu (AiT) Technology Limited, personal only, and shall be noted in the revision of the document. This test report must not be used by the client to claim product endorsement.

Reviewed by: Simba Huang
Simba Huang

Approved by: _____

Seal.chen



REPORT REVISE RECORD



Report Version	Revise Time	Issued Date	Valid Version	Notes
V1.0	/	2023.08.01	Valid	Initial Release

1 Contents

	Page
1 CONTENTS	3
2 TEST SUMMARY	5
2.1 PERFORMANCE CRITERIA	7
2.2 MONITORING EUT IN IMMUNITY TEST	8
2.2.1 Monitoring for Continuous Phenomena Applied to the EUT	8
2.3 MEASUREMENT UNCERTAINTY	11
3 TEST FACILITY	12
3.1 DEVIATION FROM STANDARD	12
3.2 ABNORMALITIES FROM STANDARD CONDITIONS	12
4 GENERAL INFORMATION	13
4.1 GENERAL DESCRIPTION OF EUT	13
4.2 EUT TEST MODE	14
4.3 DESCRIPTION OF TEST SETUP	16
4.4 TEST PERIPHERAL LIST	17
4.5 EUT PERIPHERAL LIST	17
5 EQUIPMENTS LIST FOR ALL TEST ITEMS	18
6 EMISSION TEST RESULTS	21
6.1 CONDUCTED EMISSION(AC MAINS) MEASUREMENT	21
6.1.1 E.U.T. Operation	21
6.1.2 Test Specification	21
6.1.3 Measurement Data	22
6.2 CONDUCTED EMISSION(WIRED NETWORK PORTS) MEASUREMENT	25
6.2.1 E.U.T. Operation	25
6.2.2 Test Specification	25
6.2.3 Measurement Data	26
6.3 RADIATED EMISSION MEASUREMENT	28
6.3.1 E.U.T. Operation	28
6.3.2 Test Specification	29
6.3.3 Measurement Data	30
6.4 HARMONICS	34
6.4.1 E.U.T. Operation	34
6.4.2 Test specification	34
6.4.3 Measurement Data	35
6.5 VOLTAGE CHANGES, VOLTAGE FLUCTUATIONS AND FLICKER	36
6.5.1 E.U.T. Operation	36
6.5.2 Test specification	36
6.5.3 Measurement Data	37

7 IMMUNITY TEST RESULTS	38
7.1 ELECTROSTATIC DISCHARGE IMMUNITY TEST	38
7.1.1 E.U.T. Operation	38
7.1.2 Test Specification	38
7.1.3 Measurement Data	39
7.2 RF FIELD STRENGTH IMMUNITY TEST	40
7.2.1 E.U.T. Operation	40
7.2.2 TEST PROCEDURE	40
7.2.3 Test Specification	41
7.2.4 Measurement Data	42
7.3 ELECTRICAL FAST TRANSIENT/BURST IMMUNITY TEST	44
7.3.1 E.U.T. Operation	44
7.3.2 Test specification	44
7.3.3 Measurement Data	45
7.4 SURGE IMMUNITY TEST	46
7.4.1 E.U.T. Operation	46
7.4.2 Test specification	46
7.4.3 Measurement Data	47
7.5 CONDUCTED DISTURBANCE IMMUNITY TEST	48
7.5.1 E.U.T. Operation	48
7.5.2 Test specification	48
7.5.3 Measurement Data	49
7.6 VOLTAGE DIPS AND INTERRUPTIONS IMMUNITY TEST	51
7.6.1 E.U.T. Operation	51
7.6.2 Test specification	51
7.6.3 Measurement Data	52
8 TEST SETUP PHOTOS OF THE EUT	53
9 EXTERNAL AND INTERNAL PHOTOS OF THE EUT	58

2 Test Summary

Emission Measurement		
Radiated Emission	ETSI EN 301 489-1 V2.2.3 (2019-11) ETSI EN 301 489-17 V3.2.4 (2020-09) ETSI EN 301 489-52 V1.2.1 (2021-11) ETSI EN 301 489-19 V2.1.1(2019-04) EN 55032:2015+A1:2020	PASS
Conducted Emission(AC Mains)	ETSI EN 301 489-1 V2.2.3 (2019-11) ETSI EN 301 489-17 V3.2.4 (2020-09) ETSI EN 301 489-19 V2.1.1(2019-04) ETSI EN 301 489-52 V1.2.1 (2021-11) EN 55032:2015+A1:2020	PASS
Conducted Emission(Wired network ports)	ETSI EN 301 489-1 V2.2.3 (2019-11) ETSI EN 301 489-3 V2.1.1 (2019-03) ETSI EN 301 489-17 V3.2.4 (2020-09) ETSI EN 301 489-19 V2.1.1(2019-04) ETSI EN 301 489-52 V1.2.1 (2021-11) EN 55032:2015+A1:2020	PASS
Harmonic Current Emissions	ETSI EN 301 489-1 V2.2.3 (2019-11) ETSI EN 301 489-17 V3.2.4 (2020-09) ETSI EN 301 489-19 V2.1.1(2019-04) ETSI EN 301 489-52 V1.2.1 (2021-11) EN IEC 61000-3-2:2019+A1:2021	PASS
Voltage Fluctuations and Flicker	ETSI EN 301 489-1 V2.2.3 (2019-11) ETSI EN 301 489-17 V3.2.4 (2020-09) ETSI EN 301 489-19 V2.1.1(2019-04) ETSI EN 301 489-52 V1.2.1 (2021-11) EN 61000-3-3:2013+A1: 2019	PASS
Immunity Measurement		
Electrostatic Discharge	ETSI EN 301 489-1 V2.2.3 (2019-11) ETSI EN 301 489-17 V3.2.4 (2020-09) ETSI EN 301 489-19 V2.1.1(2019-04) ETSI EN 301 489-52 V1.2.1 (2021-11) EN 55035:2017+A11:2020	PASS
RF Electromagnetic Field	ETSI EN 301 489-1 V2.2.3 (2019-11) ETSI EN 301 489-17 V3.2.4 (2020-09) ETSI EN 301 489-19 V2.1.1(2019-04) ETSI EN 301 489-52 V1.2.1 (2021-11) EN 55035:2017+A11:2020	PASS
Fast Transients Common Mode	ETSI EN 301 489-1 V2.2.3 (2019-11) ETSI EN 301 489-17 V3.2.4 (2020-09) ETSI EN 301 489-19 V2.1.1(2019-04) ETSI EN 301 489-52 V1.2.1 (2021-11) EN 55035:2017+A11:2020	PASS
RF Common Mode 0,15 MHz to 80 MHz	ETSI EN 301 489-1 V2.2.3 (2019-11) ETSI EN 301 489-17 V3.2.4 (2020-09) ETSI EN 301 489-19 V2.1.1(2019-04) ETSI EN 301 489-52 V1.2.1 (2021-11) EN 55035:2017+A11:2020	PASS
Voltage Dips and Interruptions	ETSI EN 301 489-1 V2.2.3 (2019-11) ETSI EN 301 489-17 V3.2.4 (2020-09) ETSI EN 301 489-19 V2.1.1(2019-04) ETSI EN 301 489-52 V1.2.1 (2021-11) EN 55035:2017+A11:2020	PASS

Surges	ETSI EN 301 489-1 V2.2.3 (2019-11) ETSI EN 301 489-17 V3.2.4 (2020-09) ETSI EN 301 489-19 V2.1.1(2019-04) ETSI EN 301 489-52 V1.2.1 (2021-11) EN 55035:2017+A11:2020	PASS
--------	--	------

Remark: The measurement uncertainty is not included in the test result.

2.1 PERFORMANCE CRITERIA

■ Performance Criterion of EN55035

Criterion A: The equipment shall continue to operate as intended without operator intervention. No degradation of performance or loss of function is allowed below a performance level specified by the manufacturer when the equipment is used as intended.

Criterion B: After the test, the equipment shall continue to operate as intended without operator intervention. No degradation of performance or loss of function is allowed, after the application of the phenomena below a performance level specified by the manufacturer, when the equipment is used as intended.

Criterion C: Loss of function is allowed, provided the function is self-recoverable, or can be restored by the operation of the controls by the user in accordance with the manufacturer's instructions.

2.2 MONITORING EUT IN IMMUNITY TEST

2.2.1 Monitoring for Continuous Phenomena Applied to the EUT

According to **ETSI EN 301 489-3** standard, the general performance criteria are as follows:

EN 301 489-3 PERFORMANCE CRITERIA		
Criteria	During Test	After Test
A	Operate as intended No loss of function No unintentional responses	Operate as intended No loss of function No degradation of performance No loss of stored data or user programmable functions
B	May show loss of function No unintentional responses	Operate as intended Lost function(s) shall be self-recoverable No degradation of performance No loss of stored data or user programmable functions
<ul style="list-style-type: none"> • performance criterion A applies for immunity tests with phenomena of a continuous nature; • performance criterion B applies for immunity tests with phenomena of a transient nature. 		
<p>Where "operate as intended" or "no loss of function" is specified, the EUT shall demonstrate correct functioning as described in EN 301 489-3 clause 5.</p> <p>Where the EUT has more than one mode of operation, an unplanned transition from one mode to another is considered as an unintentional response. The EUT shall be tested in sufficient modes to confirm there are no such unintentional responses.</p>		

According to **ETSI EN 301 489-19** standard, the general performance criteria are as follows:

EN 301 489-19 PERFORMANCE CRITERIA_GPS
<p>Performance criteria for Continuous phenomena applied to ROMES and ROGNSS receivers (CR) For the EUT, excluding spot frequency tests as part of the immunity test with radiated RF electromagnetic fields (see ETSI EN 301 489-1 [1], clause 9.2):</p> <ul style="list-style-type: none"> • the general performance criteria set out in clause 6.1; • during the test no false calls shall occur; • at the conclusion of the test comprising the series of individual exposures, the EUT shall operate as intended with no loss of functions or stored data (messages), as declared by the manufacturer.
<p>Performance criteria for Transient phenomena applied to ROMES and ROGNSS receivers (TR) For the EUT:</p> <ul style="list-style-type: none"> • the general performance criteria set out in clause 6.1; • during the test no false calls shall occur; • at the conclusion of the test comprising the series of individual exposures, the EUT shall operate as intended with no loss of function and/or stored data (messages), as declared by the manufacturer.

According to ETSI EN 301 489-17 standard, the general performance criteria are as follows:

EN 301 489-17 PERFORMANCE CRITERIA_ Bluetooth/WLAN		
Criteria	During Test	After Test (i.e. as a result of the application of the test)
A	Shall operate as intended. (see note). Shall be no loss of function. Shall be no unintentional transmissions.	Shall operate as intended. Shall be no degradation of performance. Shall be no loss of function. Shall be no loss of critical stored data.
B	May be loss of function.	Functions shall be self-recoverable. Shall operate as intended after recovering. Shall be no loss of critical stored data.
C	May be loss of function.	Functions shall be recoverable by the operator. Shall operate as intended after recovering. Shall be no loss of critical stored data.
<p>The performance criteria A shall apply for continuous phenomena. The performance criteria B shall apply for transient phenomena, except for voltage dips greater than or equal to 100 ms and voltage interruptions of 5 000 ms duration, for which performance criteria C shall apply. Where the EUT is a transmitter in standby mode or receive mode, unintentional transmission shall not occur during the test.</p>		
<p>Note: Operate as intended during the test allows a level of degradation in accordance with the Minimum performance level.</p>		
Minimum performance level		
<p>For equipment that supports a PER or FER, the minimum performance level shall be a PER or FER less than or equal to 10 %. For equipment that does not support a PER or a FER, the minimum performance level shall be no loss of the wireless transmission function needed for the intended use of the equipment.</p>		

According to ETSI EN 301 489-52 standard, the general performance criteria are as follows:

CLAUSE 6 OF EN 301 489-52_(GSM/WCDMA/LTE/NR)	
Criteria	Performance criteria
CT/CR	<p>Performance criteria for Continuous phenomena applied to Transmitters (CT) A communication link shall be established at the start of the test, and maintained during the test, see clauses 4.2.3 and 4.2.4. NOTE: When there is a high_level background noise present the filter bandwidth can be reduced down to a minimum of 40 Hz. At the conclusion of the test, the EUT shall operate as intended with no loss of user control functions or stored data, and the communication link shall have been maintained. In addition to confirming the above performance during a call, the test shall also be performed in idle mode, and the transmitter shall not unintentionally operate.</p>
	<p>Performance criteria for Continuous phenomena applied to Receivers (CR) A communications link shall be established at the start of the test, see appropriate clauses 4.2 to 4.2.6. During the test, the RXQUAL of the downlink shall not exceed the value of three, measured during each individual exposure in the test sequence. During the test, the downlink speech output level shall be at least 35 dB less than the previously recorded reference levels, when measured through an audio band pass filter of width 200 Hz, centered on 1 kHz (audio breakthrough check).</p>

	<p>NOTE: When there is a high level background noise present the filter bandwidth can be reduced down to a minimum of 40 Hz.</p> <p>At the conclusion of the test, the EUT shall operate as intended with no loss of user control functions or stored data, and the communication link shall have been maintained.</p>
<p>TT/TR</p>	<p>Performance criteria for Transient phenomena applied to Transmitters (TT)</p> <p>A communications link shall be established at the start of the test, see appropriate clauses 4.2 to 4.2.4.</p> <p>At the conclusion of each exposure the EUT shall operate with no user noticeable loss of the communication link.</p> <p>At the conclusion of the total test comprising the series of individual exposures, the EUT shall operate as intended with no loss of user control functions or stored data, as declared by the manufacturer, and the communication link shall have been maintained.</p> <p>In addition to confirming the above performance during a call, the test shall also be performed in idle mode, and the transmitter shall not unintentionally operate.</p>
	<p>Performance criteria for Transient phenomena applied to Receivers (TR)</p> <p>A communications link shall be established at the start of the test, see appropriate clauses 4.2. to 4.2.6.</p> <p>At the conclusion of each exposure the EUT shall operate with no user noticeable loss of the communication link.</p> <p>At the conclusion of the total test comprising the series of individual exposures, the EUT shall operate as intended with no loss of user control functions or stored data, as declared by the manufacturer, and the communication link shall have been maintained.</p> <p>Performance criteria for ancillary equipment tested on a standard basis</p> <p>The provision of ETSI EN 301 489-1 [1], clause 6.4 shall apply.</p>

Note:

For data transmission, the EUT was assessed in the following methods:

For WCDMA testing, the BER (as referred in TS 134 109 [9]) is used, it shall not exceed 0.1% during the test sequence.

For LTE testing, the throughput (as referred in TS 134 109 [9]) is used, it shall not exceed 0.1% during the test sequence.

Note: All test modes have been tested during the test.

2.3 MEASUREMENT UNCERTAINTY

The report uncertainty of measurement $y \pm U$, where expanded uncertainty U is based on a standard uncertainty Multiplied by a coverage factor of $k=2$, providing a level of confidence of approximately 95% .

No.	Item	Frequency Range	U , Value
1	Power Line Conducted Emission	150KHz~30MHz	1.20 dB
2	Disturbance Power Emission	30MHz~300MHz	2.96 dB
3	Radiated Emission Test	30MHz~1GHz	3.75 dB
4	Radiated Emission Test	1GHz~18GHz	3.88 dB

3 Test Facility

The test facility is recognized, certified or accredited by the following organizations:

CNAS- Registration No: L6177

Dongguan Yaxu (AiT) technology Limited is accredited to ISO/IEC 17025:2017 general Requirements for the competence of testing and calibration laboratories (CNAS-CL01 Accreditation Criteria for the competence of testing and calibration laboratories) on April 18, 2022

FCC-Registration No.: 703111 Designation Number: CN1313

Dongguan Yaxu (AiT) technology Limited has been registered and fully described in a report filed with the (FCC) Federal Communications Commission. The acceptance letter from the FCC is maintained in our files.

IC —Registration No.: 6819A CAB identifier: CN0122

The 3m Semi-anechoic chamber of Dongguan Yaxu (AiT) technology Limited has been registered by Certification and Engineering Bureau of Industry Canada for radio equipment testing with Registration No.: 6819A

A2LA-Lab Cert. No.: 6317.01

Dongguan Yaxu (AiT) technology Limited has been accredited by A2LA for technical competence in the field of electrical testing, and proved to be in compliance with ISO/IEC 17025: 2017 General Requirements for the Competence of Testing and Calibration Laboratories and any additional program requirements in the identified field of testing.

3.1 Deviation from Standard

None

3.2 Abnormalities from Standard Conditions

None

4 General Information

4.1 GENERAL DESCRIPTION OF EUT

Manufacturer:	Shenzhen DOKE Electronic Co., Ltd
Manufacturer Address:	801, Building3, 7th Industrial Zone, Yulv Community, Yutang Road, Guangming District, Shenzhen, China.
EUT Name:	Tablet
Model No:	Active 6
Serial Model:	N/A
Brand Name:	Blackview
Difference Description	N/A
Radio parts supported	<input checked="" type="checkbox"/> GSM <input checked="" type="checkbox"/> UMTS <input checked="" type="checkbox"/> LTE <input checked="" type="checkbox"/> GPS&GALILEO&BEIDOU&GLONASS <input checked="" type="checkbox"/> BLUETOOTH <input checked="" type="checkbox"/> 2.4GWIFI <input checked="" type="checkbox"/> FM <input checked="" type="checkbox"/> EGPRS
H/W No.:	DK051-T616-V1.0
S/W No.:	Active6_EEA_T30_V1.0_20230711V01
Adapter:	Model:HJ-C6-33-EU Input:100-240V 50/60Hz 0.35A Output: 5.0V 3.0A 15W,9V 3A 27W,12 2.5A 30W,15V 2A 30W, 20V 1.5A 30W, PPS 3.3~11V 3A 33W Max
Battery:	3.87V 13000mAh

4.2 EUT TEST MODE

MODE 1 OPERATING MODE	<p>Specification A: GSM 900 Specification: MS + Battery + Adapter</p> <p>Specification B: DCS 1800 Specification: MS + Battery + Adapter</p> <p>Specification C: UMTS 2100 Specification: MS + Battery + Adapter</p> <p>Specification D: UMTS 900 Specification: MS + Battery + Adapter</p> <p>Specification E: GPRS 900 Specification: MS + Battery + Adapter</p> <p>Specification F: GPRS 1800 Specification: MS + Battery + Adapter</p> <p>Specification G: EGPRS 900 Specification: MS + Battery + Adapter</p> <p>Specification H: EGPRS 1800 Specification: MS + Battery + Adapter</p> <p>Specification I: HSPA 2100 Specification: MS + Battery + Adapter</p> <p>Specification J: HSPA 900 Specification: MS + Battery + Adapter</p> <p>Specification K: LTE band 1 Specification: MS + Battery + Adapter</p> <p>Specification L: LTE band 3 Specification: MS + Battery + Adapter</p> <p>Specification N: LTE band 7 Specification: MS + Battery + Adapter</p> <p>Specification N: LTE band 8 Specification: MS + Battery + Adapter</p> <p>Specification N: LTE band 20 Specification: MS + Battery + Adapter</p> <p>Specification N: LTE band 38 Specification: MS + Battery + Adapter</p> <p>Specification N: LTE band 40 Specification: MS + Battery + Adapter</p>
MODE 2 BLUETOOTH MODE	<p>Specification: MS + Battery+ Adapter</p>
MODE 3 2.4GWIFI MODE	<p>Specification: MS + Battery+ Adapter</p>
MODE 4 FM MODE	<p>Specification: MS + Battery+ Adapter</p>

MODE 5 GPS&GALILEO&BEIDOU& GLONASS& GLONASS MODE	Specification: MS + Battery+ Adapter
MODE 6	Camera (By Adapter Charging)
MODE 7	Sound Recorder (By Adapter Charging)
MODE 8	Audio Play (By Adapter Charging)
MODE 9	Video Play (By Adapter Charging)
MODE 10	IDLE Mode (By Adapter Charging)
MODE 11	USB Mode (By PC data transferring)
Note: EMI and EMS contain the above test modes. All the modes had been tested but only the worst data recorded in the report.	

Note:

1) ■ is operation mode.

2) Pre-scan above all test mode, found below test mode which it was worse case mode. Test results reported represents the worst case simultaneous transmission condition.

Pre-test conducted emission and radiated emission at both voltage AC 120V/60Hz and AC 230V/50Hz, recorded worst case.

Pre-test radiated emission with the EUT position at X-axis,Y-axis and Z-axis, recorded worst case.

Test item	Test mode (Worse case mode)
Conducted emission	Mode 8
Radiated emission	Mode 8
EMS	All Mode

4.3 DESCRIPTION OF TEST SETUP

EUT was tested in normal configuration (Please See following Block diagrams)

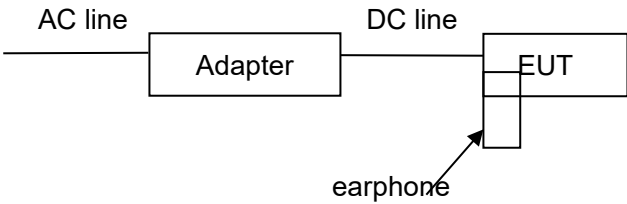
<p>1. Block diagram of EUT configuration-EMI</p>
<p>Mode1-4:</p>  <pre> graph LR AC[AC line] --- Adapter[Adapter] Adapter --- DC[DC line] DC --- EUT[EUT] Earphone[earphone] --- EUT </pre>
<p>2. Block diagram of EUT configuration-EMS</p>
<p>The same as above.</p>

4.4 TEST PERIPHERAL LIST

No.	Equipment	Manufacturer	EMC Compliance	Model No.	Serial No.	Power cord	Remark
1	Adapter	HJ	--	HJ-C6-33-EU	N/A	N/A	N/A

4.5 EUT Peripheral List

No.	Equipment	Manufacturer	EMC Compliance	Model No.	Serial No.	signal cable	Remark
1	N/A	N/A	N/A	N/A	N/A	N/A	N/A

5 EQUIPMENTS LIST FOR ALL TEST ITEMS

<input checked="" type="checkbox"/> Radiation Test Equipment						
No	Test Equipment	Manufacturer	Model No	Serial No	Cal. Date	Cal. Due Date
1	EMI Measuring Receiver	R&S	ESR	101160	2022.09.02	2023.09.01
2	Low Noise Pre Amplifier	Tsj	MLA-10K01-B01-27	1205323	2022.09.02	2023.09.01
3	TRILOG Super Broadband test Antenna	SCHWARZBECK	VULB9160	9160-3207	2021.08.29	2024.08.28
4	50Ω Coaxial Switch	Anritsu	MP59B	6200264416	2022.09.02	2023.09.01
5	Spectrum Analyzer	R&S	FSV40	101470	2022.09.02	2023.09.01
6	Low Noise Pre Amplifier	Tsj	MLA-0120-A02-34	2648A04738	2022.09.02	2023.09.01
7	Broadband Horn Antenna	Schwarzbeck	BBHA 9120D	452	2021.08.29	2024.08.28
8	Filter	MICRO-TRONICS	BRM50702-02	16	2022.09.02	2023.09.01
9	Filter	MICRO-TRONICS	BRC50703-02	17	2022.09.02	2023.09.01
10	Filter	MICRO-TRONICS	BRC50705-02	18	2022.09.02	2023.09.01

<input checked="" type="checkbox"/> Conduction Test equipment						
No	Test Equipment	Manufacturer	Model No	Serial No	Cal. Date	Cal. Due Date
1	EMI Test Receiver	R&S	ESCI	100124	2022.09.02	2023.09.01
2	LISN	Kyoritsu	KNW-242	8-837-4	2022.09.02	2023.09.01
3	LISN	R&S	ESH3-Z2	0357.8810.54-101161-S2	2022.09.02	2023.09.01
4	50Ω Coaxial Switch	Anritsu	MP59B	6200264417	2022.09.02	2023.09.01

<input checked="" type="checkbox"/> H/F Test Equipment						
No	Test Equipment	Manufacturer	Model No	Serial No	Cal. Date	Cal. Due Date
1	Signal Conditioning Unit	Schaffner	CCN1000-1	72472	2022.09.02	2023.09.01
2	5KV AC Power Source	Schaffner	NSG1007-5-208-413	57227	2022.09.02	2023.09.01

<input checked="" type="checkbox"/> ESD Test Equipment						
No	Test Equipment	Manufacturer	Model No	Serial No	Cal. Date	Cal. Due Date
1	ESD Simulator	Schaffner	NSG435	5866	2022.09.02	2023.09.01

<input checked="" type="checkbox"/> R/S Test Equipment						
No	Test Equipment	Manufacturer	Model No	Serial No	Cal. Date	Cal. Due Date
1	MXG analog signal generator	Agilent	N5181A	MY46240859	2022.09.02	2023.09.01
2	Power Amplifier	Schaffner	CBA9433	T43574	2022.09.02	2023.09.01
3	Power Amplifier	Schaffner	CBA9409	T43605	2022.09.02	2023.09.01
4	Power Amplifier	Micotop	MPA-3000-6000-50	MPA03724	2022.09.02	2023.09.01
5	Logarithmic-periodic Antenna	Schwarzbeck	VULP9118E	820	2022.09.02	2023.09.01
6	Broadband Horn Antenna	Schwarzbeck	BBHA 9120LF	255	2022.09.02	2023.09.01
7	Power meter	Agilent	E4419B	MY45102079	2022.09.02	2023.09.01
8	Power sensor	Agilent	8481A	MY41097696	2022.09.02	2023.09.01
9	Power sensor	Agilent	8481A	MY41097697	2022.09.02	2023.09.01
10	RF Relay matrix	tsj	RFM-S621	04261	2022.09.02	2023.09.01

<input checked="" type="checkbox"/> EFT/B Test equipment						
No	Test Equipment	Manufacturer	Model No	Serial No	Cal. Date	Cal. Due Date
1	INS6501 Step-transformer	Schaffner	INA 6501	136	2022.09.02	2023.09.01
2	MODULA GENERATOR	Schaffner	MODULA 6150	34475	2022.09.02	2023.09.01
3	Capacitive Coupling Clamp	Schaffner	CDN8014	22519	2022.09.02	2023.09.01

<input checked="" type="checkbox"/> Surge Test Equipment						
No	Test Equipment	Manufacturer	Model No	Serial No	Cal. Date	Cal. Due Date
1	INS6501 step-transformer	Schaffner	INA 6501	136	2022.09.02	2023.09.01
2	MODULA GENERATOR	Schaffner	MODULA 6150	34475	2022.09.02	2023.09.01

<input checked="" type="checkbox"/> C/S Test Equipment						
No	Test Equipment	Manufacturer	Model No	Serial No	Cal. Date	Cal. Due Date
1	SML01 Signal Generator	R&S	SML01	104531	2022.09.02	2023.09.01
2	Power Amplifier	Schaffner	CBA9437	T43660	2022.09.02	2023.09.01
3	Attenuator	Aeroflex / Weinschel	40-6-33	PA130	2022.09.02	2023.09.01
4	Power Line CDN	tsj	TSCDN-M1-16A	07010	2022.09.02	2023.09.01
5	Power Line CDN	tsj	TSCDN-M2-16A	07024	2022.09.02	2023.09.01
6	Power Line CDN	tsj	TSCDN-M3-16A	07032	2022.09.02	2023.09.01

<input checked="" type="checkbox"/> PFMF Test Equipment						
No	Test Equipment	Manufacturer	Model No	Serial No	Cal. Date	Cal. Due Date
1	Magnetic field generator	Schaffner	MFO6501	34299	2022.09.02	2023.09.01
2	Magnetic Field Loop Antenna	Schaffner	INA 702	148	2022.09.02	2023.09.01

<input checked="" type="checkbox"/> Dips Test Equipment						
No	Test Equipment	Manufacturer	Model No	Serial No	Cal. Date	Cal. Due Date
1	INS6501 Step-transformer	Schaffner	INA 6501	136	2022.09.02	2023.09.01
2	MODULA GENERATOR	Schaffner	MODULA 6150	34475	2022.09.02	2023.09.01

<input checked="" type="checkbox"/> Others Test Equipment						
No	Test Equipment	Manufacturer	Model No	Serial No	Cal. Date	Cal. Due Date
1	Wideband communication tester	R&S	CMW500	1201.0002K50	2022.09.02	2023.09.01

Note:

1. is not applicable in this Test Report. is applicable in this Test Report.

6 Emission Test Results

6.1 CONDUCTED EMISSION(AC MAINS) MEASUREMENT

Frequency (MHz)	☐ Class A (dBμV)		☒ Class B (dBμV)	
	Q.P. (Quasi-Peak)	A.V. (Average)	Q.P. (Quasi-Peak)	A.V. (Average)
0.15 ~ 0.50	79	66	66 to 56	56 to 46
0.50 ~ 5.0	73	60	56	46
5.0 ~ 30	73	60	60	50

Detector: Peak for pre-scan (9kHz Resolution Bandwidth)
 Quasi-Peak & Average if maximized peak within 6dB of Average Limit

6.1.1 E.U.T. Operation

Temperature:	23°C	Humidity:	55% RH	Atmospheric Pressure:	101	Kpa
Test Mode:	All Modes			The Worst Mode reported:	Mode 8	

6.1.2 Test Specification

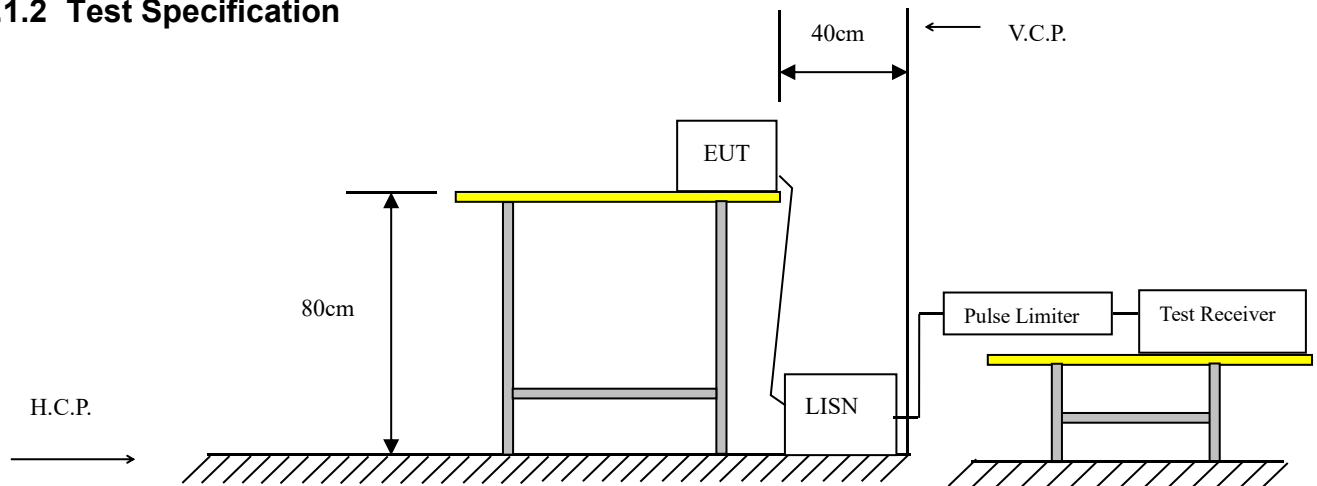

EUT was placed upon a wooden test table 0.8m above the horizontal metal reference plane and 0.4m from the vertical ground plane, and it was connected to an AMN. The closest distance between the boundary of the EUT and the surface of the AMN is 0.8m. All peripherals were connected to another AMN, and placed at a distance of 10cm from each other. A spectrum and receiver was connected to the RF output port of the AMN. Both average and quasi-peak value were detected.

6.1.3 Measurement Data

An initial pre-scan was performed on the live and neutral lines.

Quasi-peak or average measurements were performed at the frequency which maximum peak emissions were detected.

Please refer to the attached quasi-peak & average measurement data.

Model name:	Active 6	Test Date :	2023-07-17
Test Mode:	Mode 8	Phase :	Line
Test Voltage:	AC 230V/50Hz	Test Result:	<input checked="" type="checkbox"/> Pass <input type="checkbox"/> Fail

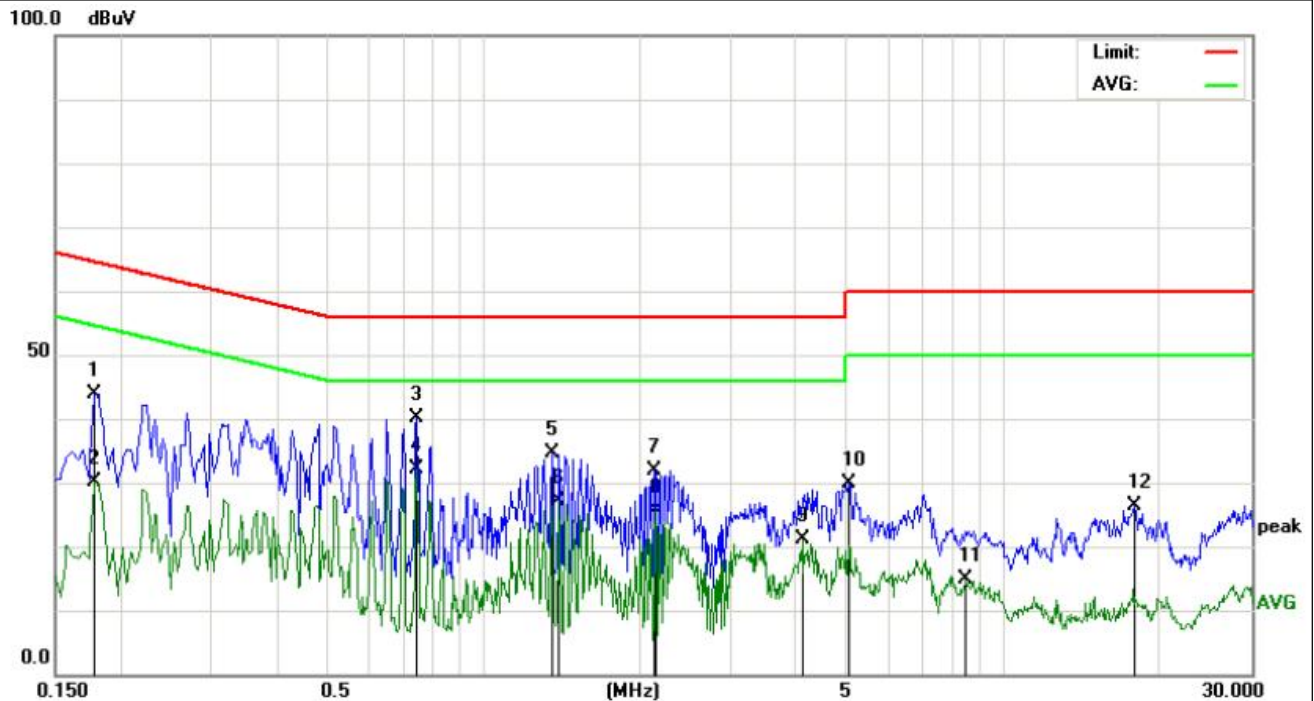

Remark: Correct Factor = LISN factor + Cable Loss + Pulse limiter factor.

Measurement Result=Reading Level +Correct Factor;

Over Limit= Measurement Result- Limit;

No.	Mk.	Freq. MHz	Reading Level dBuV	Correct Factor dB	Measure- ment dBuV	Limit dBuV	Over dB	Detector
1		0.1780	32.52	11.41	43.93	64.57	-20.64	QP
2		0.1780	18.76	11.41	30.17	54.57	-24.40	AVG
3		0.7460	30.13	9.97	40.10	56.00	-15.90	QP
4	*	0.7460	22.20	9.97	32.17	46.00	-13.83	AVG
5		1.3540	24.77	9.96	34.73	56.00	-21.27	QP
6		1.3980	17.06	9.96	27.02	46.00	-18.98	AVG
7		2.1340	21.89	10.00	31.89	56.00	-24.11	QP
8		2.1460	15.62	10.00	25.62	46.00	-20.38	AVG
9		4.1100	10.98	10.06	21.04	46.00	-24.96	AVG
10		5.0340	19.79	10.11	29.90	60.00	-30.10	QP
11		8.4900	4.62	10.19	14.81	50.00	-35.19	AVG
12		17.9220	15.54	10.80	26.34	60.00	-33.66	QP

Model name:	Active 6	Test Date :	2023-07-17
Test Mode:	Mode 8	Phase :	Neutral
Test Voltage:	AC 230V/50Hz	Test Result:	<input checked="" type="checkbox"/> Pass <input type="checkbox"/> Fail

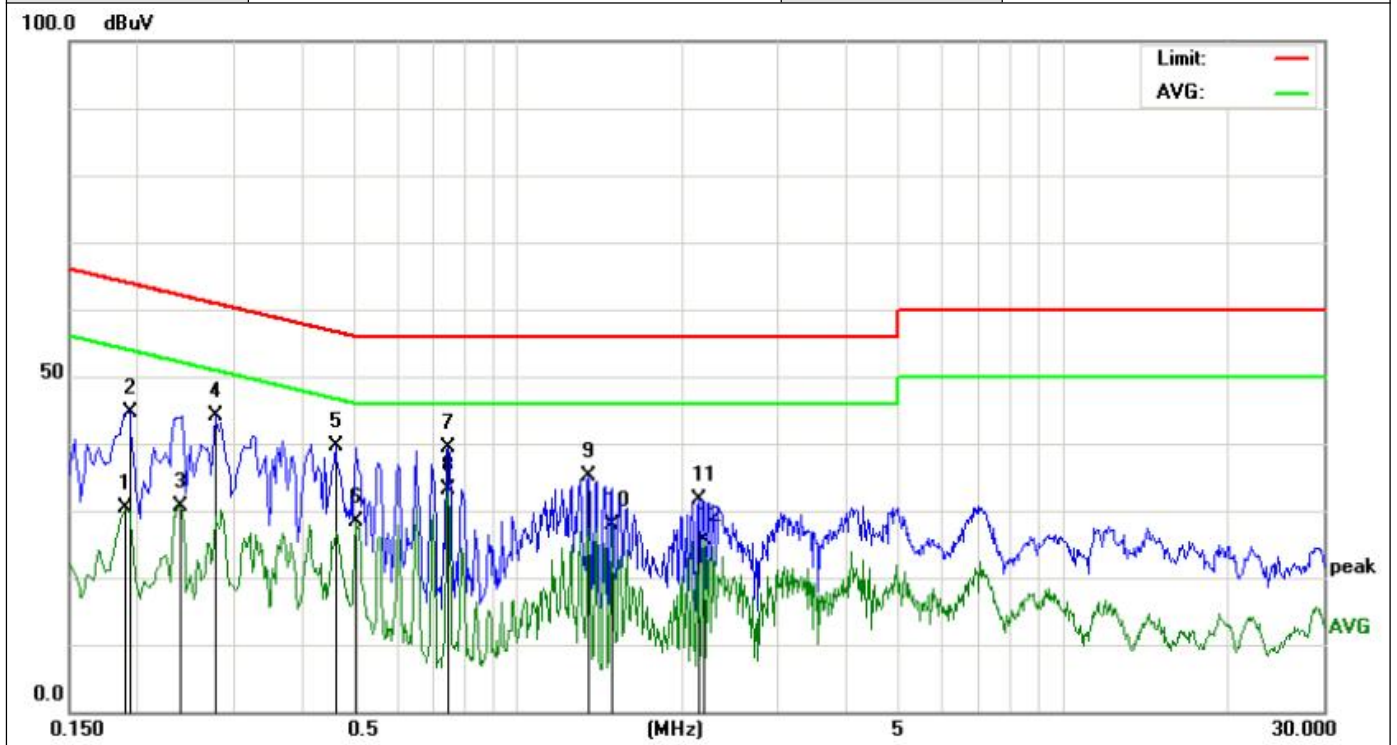

Remark: Correct Factor = LISN factor + Cable Loss + Pulse limiter factor.

Measurement Result=Reading Level +Correct Factor;

Over Limit= Measurement Result- Limit;

No.	Mk.	Freq. MHz	Reading Level dBuV	Correct Factor dB	Measure- ment dBuV	Limit dBuV	Over dB	Detector
1		0.1900	19.14	11.26	30.40	54.03	-23.63	AVG
2		0.1940	33.38	11.21	44.59	63.86	-19.27	QP
3		0.2380	19.73	10.93	30.66	52.16	-21.50	AVG
4		0.2779	33.23	10.80	44.03	60.88	-16.85	QP
5		0.4620	29.63	10.05	39.68	56.66	-16.98	QP
6		0.5060	18.28	10.01	28.29	46.00	-17.71	AVG
7		0.7460	29.39	9.97	39.36	56.00	-16.64	QP
8	*	0.7460	23.12	9.97	33.09	46.00	-12.91	AVG
9		1.3500	25.09	9.96	35.05	56.00	-20.95	QP
10		1.4900	17.95	9.96	27.91	46.00	-18.09	AVG
11		2.1460	21.62	10.00	31.62	56.00	-24.38	QP
12		2.1900	15.58	10.00	25.58	46.00	-20.42	AVG

6.2 CONDUCTED EMISSION(WIRED NETWORK PORTS) MEASUREMENT

Frequency (MHz)	<input type="checkbox"/> Class A (dB μ V)		<input checked="" type="checkbox"/> Class B (dB μ V)	
	Q.P. (Quasi-Peak)	A.V. (Average)	Q.P. (Quasi-Peak)	A.V. (Average)
0.15 ~ 0.50	97 to 87	84 to 74	84 to 74	74 to 64
0.50 ~ 30	87	74	74	64

Detector:	Peak for pre-scan (9kHz Resolution Bandwidth) Quasi-Peak & Average if maximized peak within 6dB of Average Limit
-----------	---

6.2.1 E.U.T. Operation

Temperature:	23°C	Humidity:	55% RH	Atmospheric Pressure:	101	Kpa
Test Mode:	All Modes		The Worst Mode reported:		Mode 4	

6.2.2 Test Specification

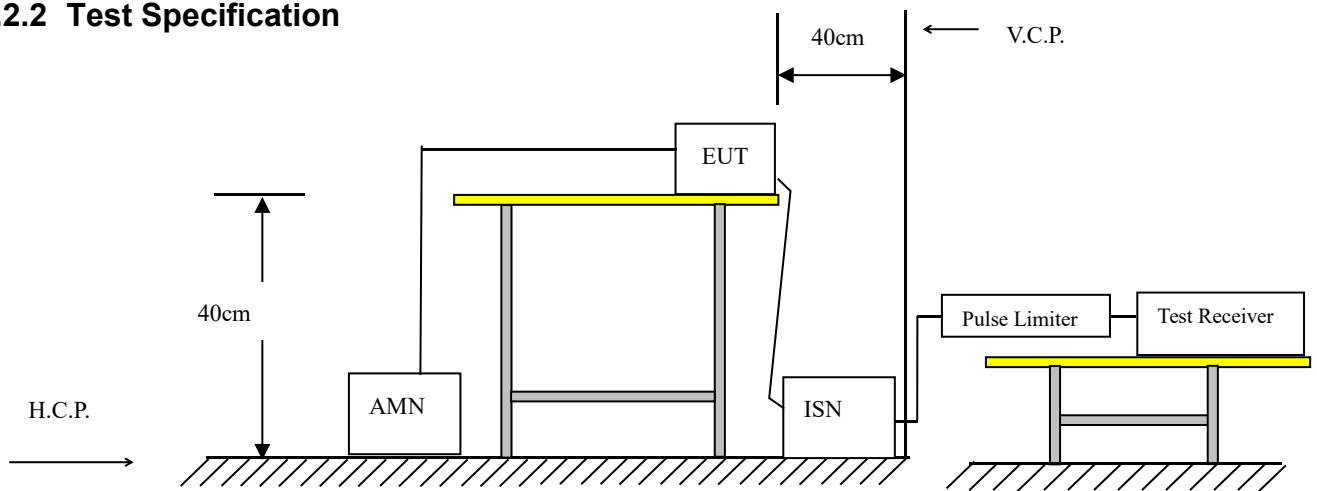

EUT was placed upon a wooden test table 0.4m above the horizontal metal reference plane and 0.4m from the vertical ground plane, and it was connected to an AMN. The closest distance between the boundary of the EUT and the surface of the AMN is 0.8m. All peripherals were connected to another AMN, and placed at a distance of 10cm from each other. A ISN is used for connect the Wired network ports of the EUT and the Test Peripheral, A spectrum and receiver was connected to the RF output port of the ISN. Both average and quasi-peak value were detected.

6.2.3 Measurement Data

Not Applicable

6.3 RADIATED EMISSION MEASUREMENT

Limits of Radiated Emission Measurement (Below 1GHz)

Frequency (MHz)	<input type="checkbox"/> Class A (10m)	<input checked="" type="checkbox"/> Class B (3m)
	Quasi-Peak dB(μV/m)	Quasi-Peak dB(μV/m)
30 ~ 230	40.0	40.0
230 ~ 1000	47.0	47.0

Limits of Radiated Emission Measurement (Above 1GHz)

Frequency (MHz)	<input type="checkbox"/> Class A (3m)		<input checked="" type="checkbox"/> Class B (3m)	
	Quasi-Peak dB(μV/m)	Average dB(μV/m)	Quasi-Peak dB(μV/m)	Average dB(μV/m)
1000~6000	76.0	56.0	74.0	54.0

6.3.1 E.U.T. Operation

Temperature:	24°C	Humidity:	52% RH	Atmospheric Pressure:	101	Kpa
Test Mode:	All Modes		The Worst Mode reported:		Mode 8	

6.3.2 Test Specification

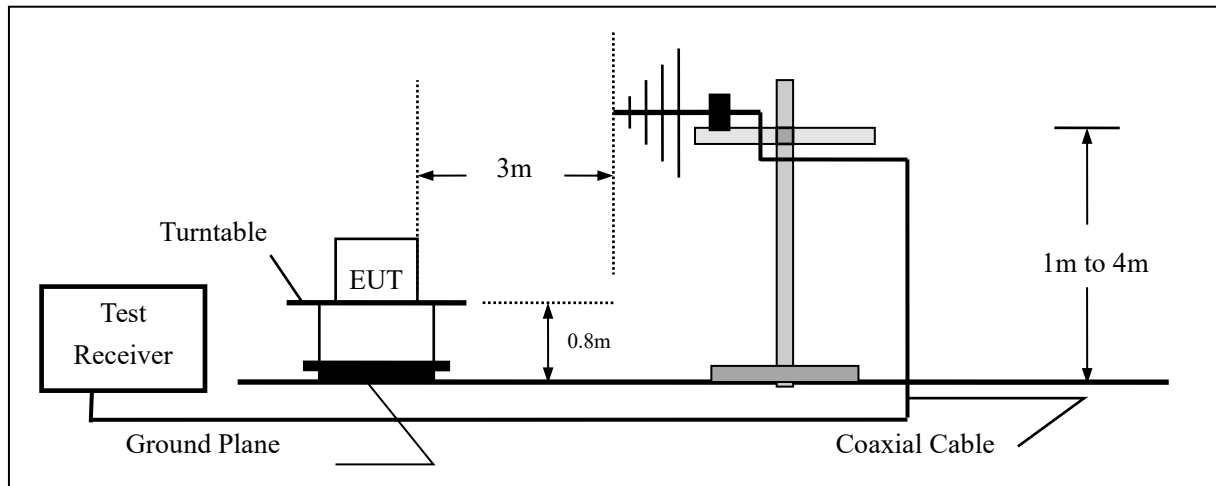

Radiated emission test set-up, frequency below 1000MHz:

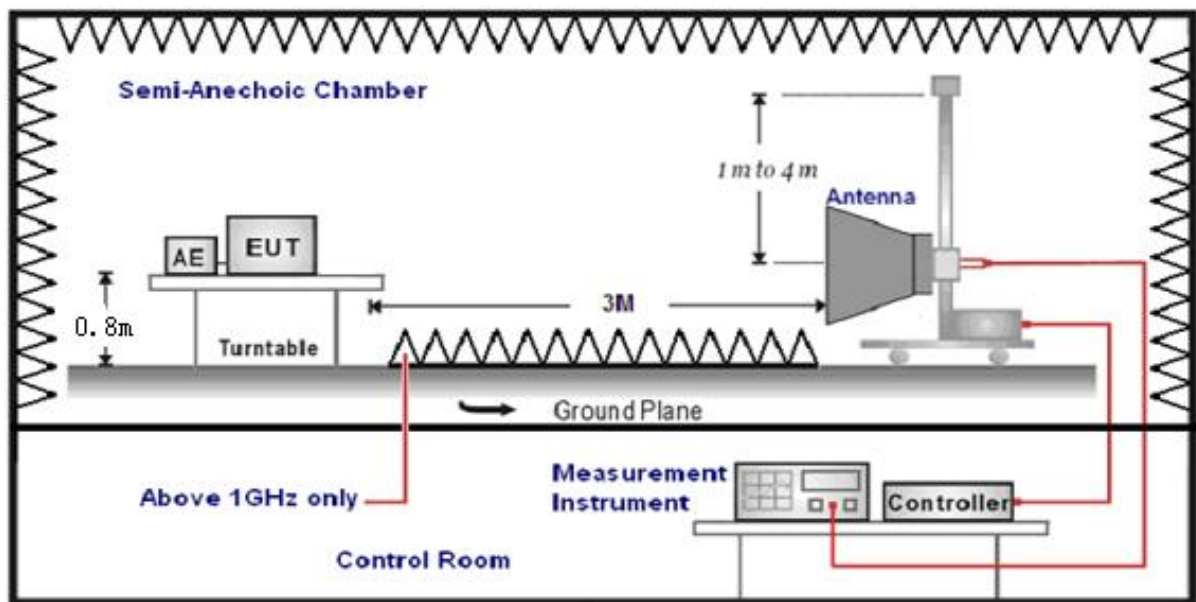

Radiated emission test set-up, frequency above 1000MHz

EUT was placed upon a wooden test table which was placed on the turn table 0.8m above the horizontal metal ground plane, and operating in the mode as mentioned above. A receiving antenna was placed 3m away from the EUT. During testing, turn around the turn table and move the antenna from 1m to 4m to find the maximum field-strength reading. All peripherals were placed at a distance of 10cm between each other. Both horizontal and vertical antenna polarities were tested.

6.3.3 Measurement Data

Below 1GHz

Model name:	Active 6	Test Date :	2023-07-18
Test Mode:	Mode 8	Phase :	Vertical
Test Voltage:	AC 230V/50Hz	Test Result:	<input checked="" type="checkbox"/> Pass <input type="checkbox"/> Fail

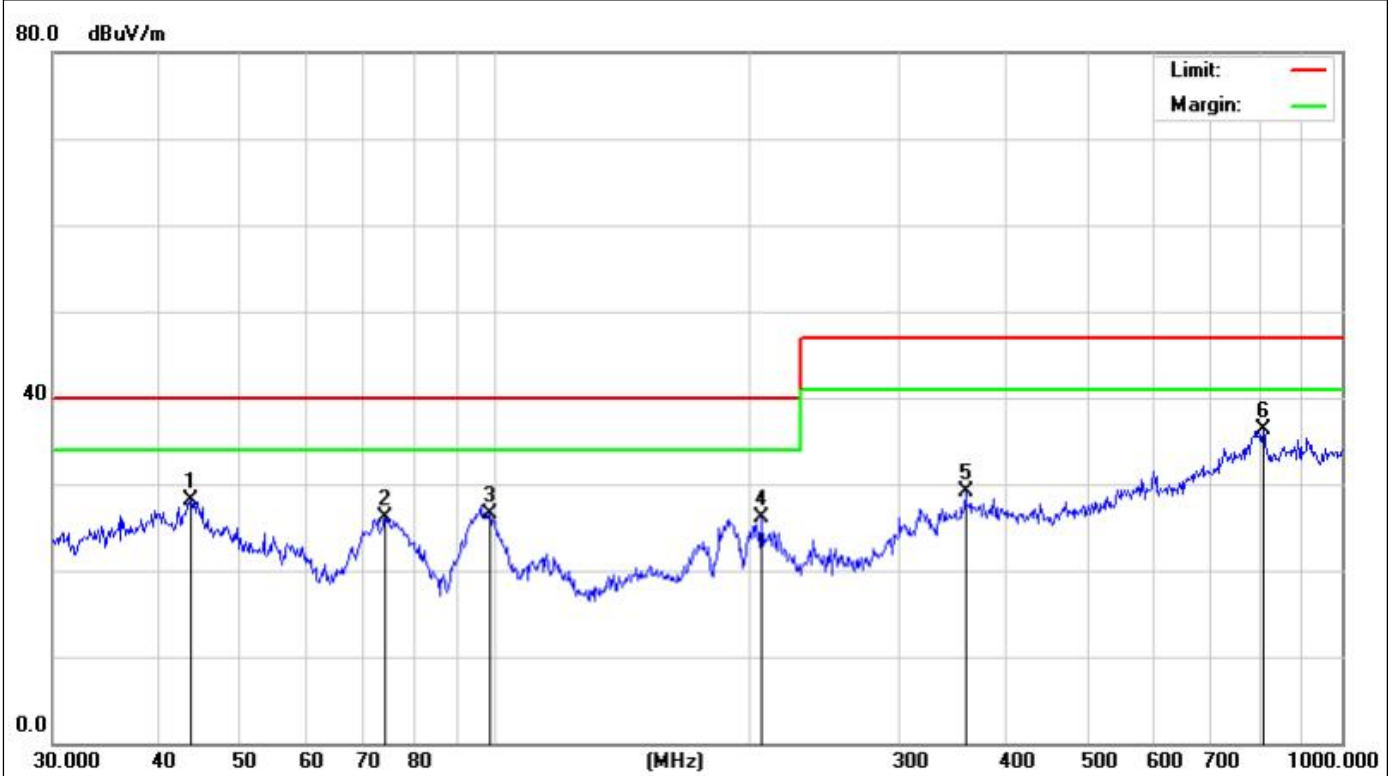

Remark: Factor = Antenna Factor + Cable Loss – Pre-amplifier.

Measurement Result=Reading Level +Correct Factor;

Over Limit= Measurement Result- Limit;

No. Mk.	Freq. MHz	Reading Level dBuV	Correct Factor dB	Measure- ment dBuV/m	Limit dBuV/m	Over dB	Detector
1	43.6584	26.62	1.42	28.04	40.00	-11.96	QP
2	74.1351	30.43	-4.37	26.06	40.00	-13.94	QP
3	98.4866	29.47	-3.05	26.42	40.00	-13.58	QP
4	206.3976	25.06	1.00	26.06	40.00	-13.94	QP
5	359.1860	23.63	5.49	29.12	47.00	-17.88	QP
6 *	807.4291	23.46	12.75	36.21	47.00	-10.79	QP

Note: While performing the testing, the notch filter is used for avoiding test instrument overload.

Model name:	Active 6	Test Date :	2023-07-18
Test Mode:	Mode 8	Polarization :	Horizontal
Test Voltage:	AC 230V/50Hz	Test Result:	<input checked="" type="checkbox"/> Pass <input type="checkbox"/> Fail



Remark: Factor = Antenna Factor + Cable Loss – Pre-amplifier.
 Measurement Result=Reading Level +Correct Factor;
 Over Limit= Measurement Result- Limit;

No. Mk.	Freq. MHz	Reading Level dBuV	Correct Factor dB	Measure- ment dBuV/m	Limit dBuV/m	Over dB	Detector
1	49.3594	26.01	2.65	28.66	40.00	-11.34	QP
2	97.7983	28.40	-2.19	26.21	40.00	-13.79	QP
3	225.3080	30.12	-0.50	29.62	40.00	-10.38	QP
4	318.8170	28.81	2.04	30.85	47.00	-16.15	QP
5	528.2458	24.37	9.36	33.73	47.00	-13.27	QP
6 *	785.0935	23.87	12.80	36.67	47.00	-10.33	QP

Note: While performing the testing, the notch filter is used for avoiding test instrument overload.

Above 1GHz

Model name:	Active 6	Test Date :	2023-07-18
Test Mode:	Mode 8	Phase :	Vertical
Test Voltage:	AC 230V/50Hz	Test Result:	<input checked="" type="checkbox"/> Pass <input type="checkbox"/> Fail

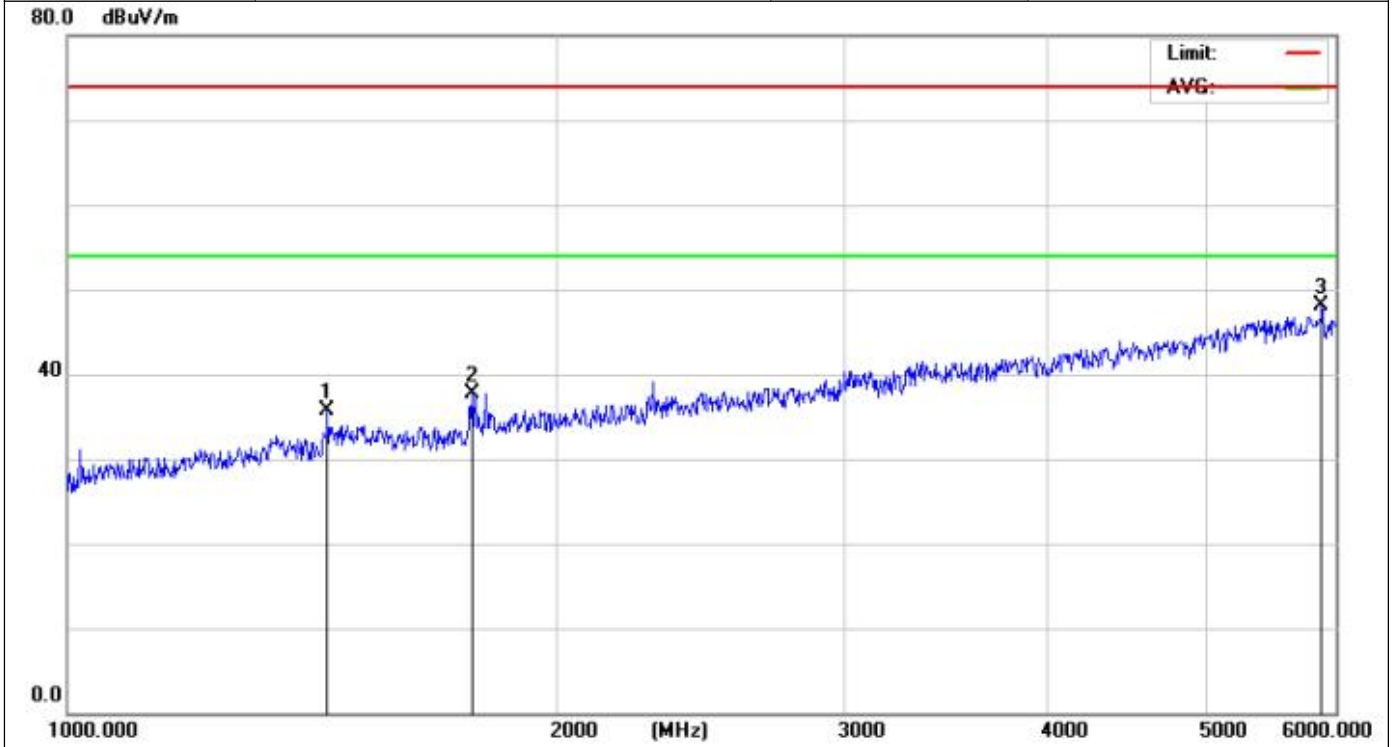

Remark: Factor = Antenna Factor + Cable Loss – Pre-amplifier.

Measurement Result=Reading Level +Correct Factor;

Over Limit= Measurement Result- Limit;

No.	Mk.	Freq. MHz	Reading Level dBuV	Correct Factor dB	Measure- ment dBuV/m	Limit dBuV/m	Over dB	Detector
1		1443.846	32.87	2.83	35.70	74.00	-38.30	peak
2		1771.048	34.53	3.27	37.80	74.00	-36.20	peak
3	*	5882.902	41.73	6.37	48.10	74.00	-25.90	peak

Note: While performing the testing, the notch filter is used for avoiding test instrument overload.

Model name:	Active 6	Test Date :	2023-07-18
Test Mode:	Mode 8	Polarization :	Horizontal
Test Voltage:	AC 230V/50Hz	Test Result:	<input checked="" type="checkbox"/> Pass <input type="checkbox"/> Fail

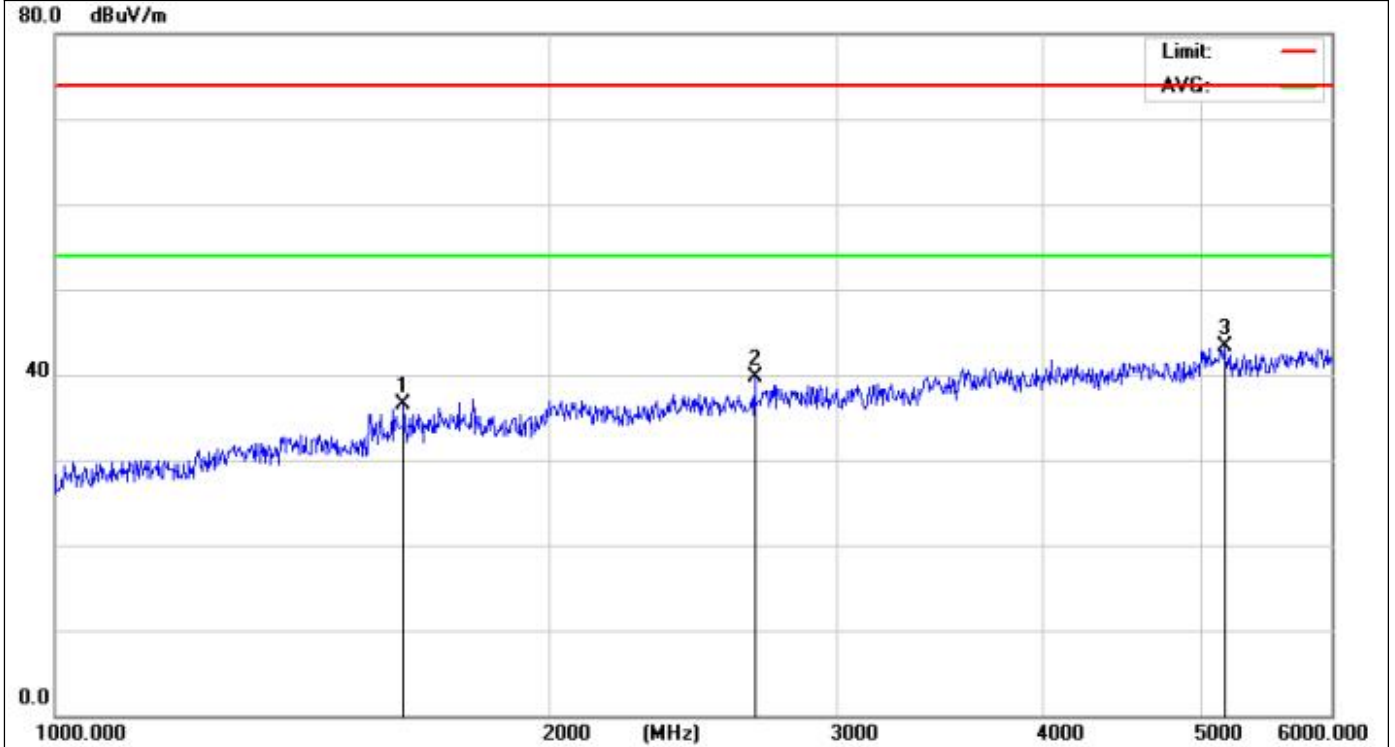

Remark: Factor = Antenna Factor + Cable Loss – Pre-amplifier.

Measurement Result=Reading Level +Correct Factor;

Over Limit= Measurement Result- Limit;

No.	Mk.	Freq. MHz	Reading Level dBuV	Correct Factor dB	Measure- ment dBuV/m	Limit dBuV/m	Over dB	Detector
1		1630.930	33.62	2.98	36.60	74.00	-37.40	peak
2		2669.481	35.68	4.12	39.80	74.00	-34.20	peak
3	*	5161.626	37.54	5.86	43.40	74.00	-30.60	peak

Note: While performing the testing, the notch filter is used for avoiding test instrument overload.

6.4 HARMONICS

Frequency Range: 100Hz to 2kHz

Test Requirement: EN 61000-3-2

6.4.1 E.U.T. Operation

Temperature:	25°C	Humidity:	50% RH	Atmospheric Pressure:	101	Kpa
Test Mode:	All Modes			The Worst Mode reported:	Mode 8	

6.4.2 Test specification

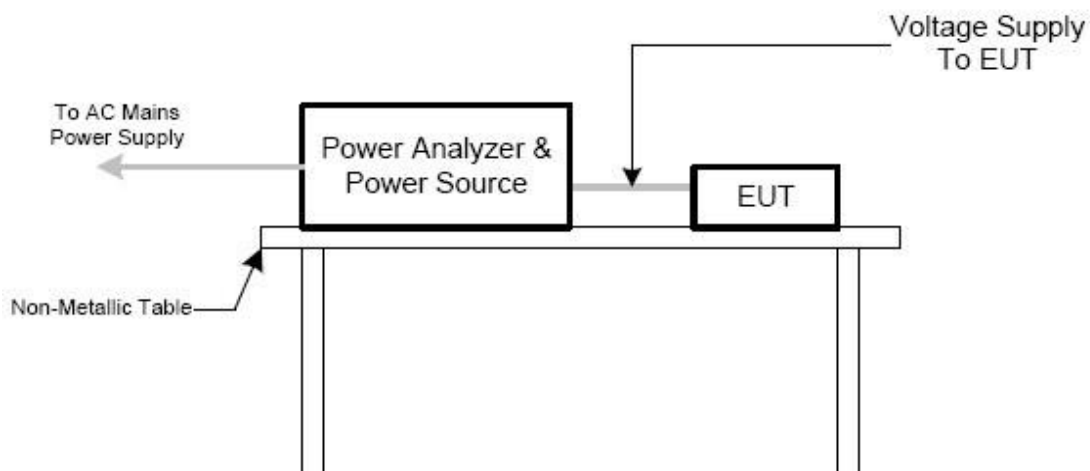

EUT operated in the mode as mentioned above, and connected to Harmonic/Flicker measuring equipment which was connected to an AC power source. Measurement was performed after EUT operating in static state for 10 seconds. Each order harmonics found to meet the relevant limits.

6.4.3 Measurement Data

Test Requirement:	EN IEC 61000-3-2
Frequency range:	100Hz to 2kHz
Measurement Time:	3 min
Test result:	N/A (See Remark Below)

Remark:

Since the EUT (rated power is less than 75W) was belong to exception of clause 7 and Annex C, according to EN 61000-3-2 figure 1, it was deemed to conform to the requirements of this standard without further testing.

“The procedure for applying the limits and assessing the results is shown in Figure 1.

For the following categories of equipment limits are not specified in this edition of the standard.

Note 1: Equipment with a rated power of 75W or less, other than lighting equipment.

NOTE 2 This value may be reduced from 75 W to 50 W in the future, subject to approval by National Committees at that time.

- professional equipment with a total rated power greater than 1 kW;
- symmetrically controlled heating elements with a rated power less than or equal to 200 W;
- independent dimmers for incandescent lamps with a rated power less than or equal to 1 kW.

NOTE 3 See also C.5.3.”

And

No limit applies for all lighting equipments with active input power ≤ 25 W except Discharge lighting equipment (refer to 7.3 b)

For further details, please refer to Clause 7 & Annex C of EN 61000-3-2 for reference.

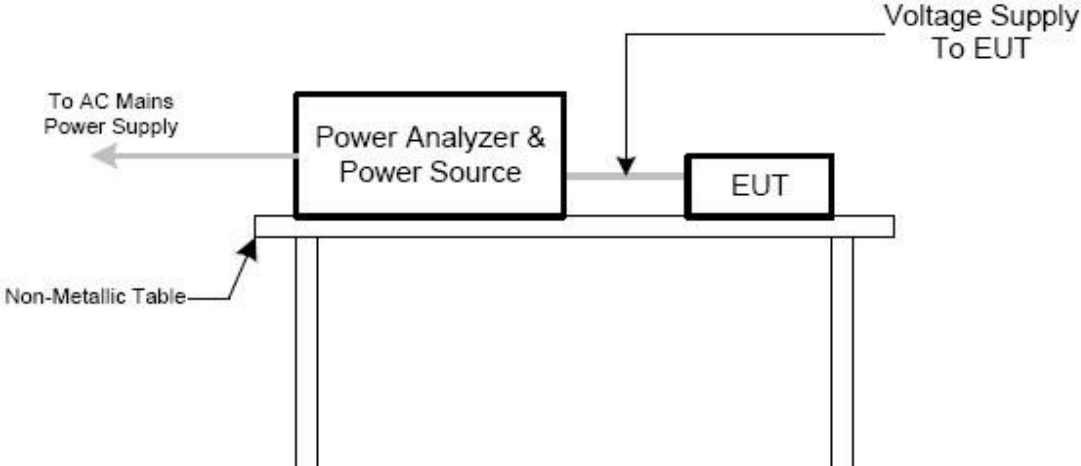
6.5 VOLTAGE CHANGES, VOLTAGE FLUCTUATIONS AND FLICKER						
Test Requirement:		EN 61000-3-3				
6.5.1 E.U.T. Operation						
Temperature:	25°C	Humidity:	50% RH	Atmospheric Pressure:	101	Kpa
Test Mode:	All Modes			The Worst Mode:	Mode 8	
6.5.2 Test specification						
 <p>The diagram illustrates the test setup. A 'Power Analyzer & Power Source' is connected to 'To AC Mains Power Supply'. It is also connected to an 'EUT' (Equipment Under Test). A 'Voltage Supply To EUT' is also shown. The entire setup is placed on a 'Non-Metallic Table'.</p>						
<p>EUT was operated in the mode as mentioned above, and connected to Harmonic/Flicker measuring equipment which was connected to an AC power source.</p>						

6.5.3 Measurement Data

M/N:	Active 6	Test Result: <input checked="" type="checkbox"/> Pass <input type="checkbox"/> Fail
Test Voltage:	AC 230V/50Hz	Test date: 2023-07-19

Test category: All parameters (European limits) Test Margin: 100

Test Result: Pass Status: Test Completed

Pst_i and limit line

European Limits

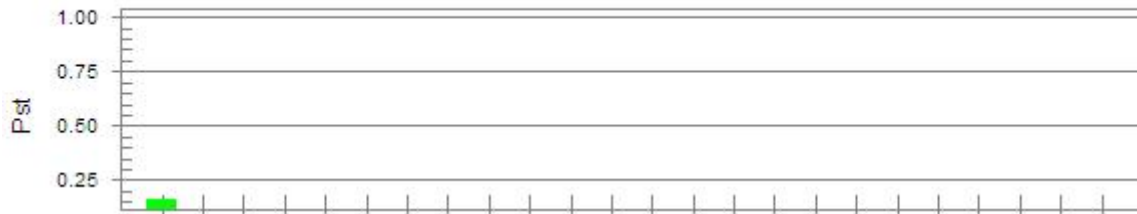

Plt and limit line

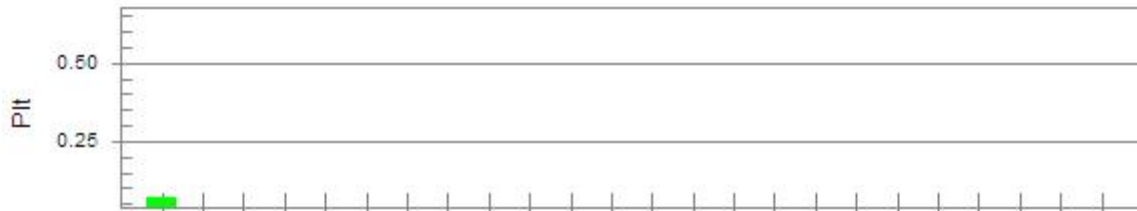

Parameter values recorded during the test:

Vrms at the end of test (Volt): 230.53

Highest dt (%):	0.21	Test limit (%):	3.30	Pass
Time(mS) > dt:	0.0	Test limit (mS):	500.0	Pass
Highest dc (%):	0.00	Test limit (%):	3.30	Pass
Highest dmax (%):	0.18	Test limit (%):	4.00	Pass
Highest Pst (10 min. period):	0.072	Test limit:	1.000	Pass
Highest Plt (2 hr. period):	0.028	Test limit:	0.650	Pass

7 Immunity Test Results

7.1 ELECTROSTATIC DISCHARGE IMMUNITY TEST

Acceptable Performance Criterion:	B
Discharge Impedance:	330 Ω / 150 pF
Discharge Voltage:	Air Discharge: ±4 kV, ±8 kV
	Contact Discharge: ±2 kV, ±4 kV
	VCP, HCP: ±2 kV, ±4 kV
Polarity:	Positive & Negative
Minimum discharge Interval:	1 second

7.1.1 E.U.T. Operation

Temperature:	25°C	Humidity:	50% RH	Atmospheric Pressure:	101	Kpa
Test Mode:	All Modes					

7.1.2 Test Specification

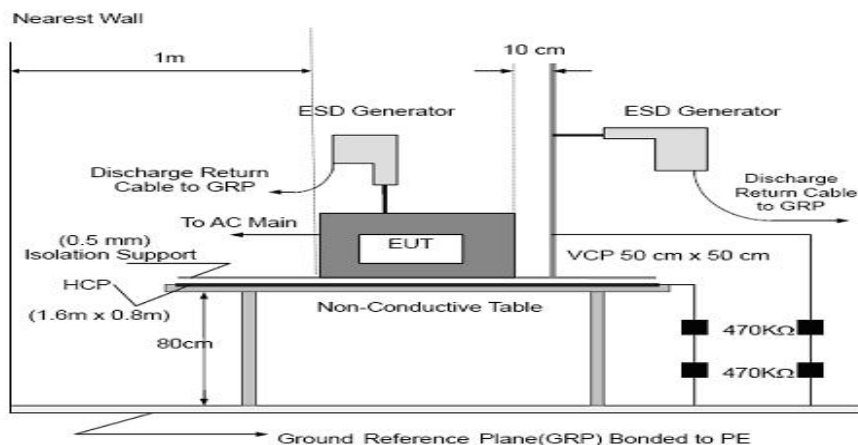

EUT was operated in the mode as mentioned above. Both contact and air discharge was executed. Contact discharge to the conductive surfaces and to coupling planes; air discharge at insulating surfaces. Each test point shall be subjected to 10 discharges at least (For each voltage and polarity).

7.1.3 Measurement Data

Test Record

Electrostatic Discharge Test Results																		
M/N:	Active 6								Test Result: <input checked="" type="checkbox"/> Pass <input type="checkbox"/> Fail									
Test Voltage:	AC 230V/50Hz								Test date: 2023-07-19									
Discharge times	Contact discharge: minimum <u>10</u> times (+/-respectively) at each point, Air discharge: minimum <u>10</u> times (+/- respectively) at each point.																	
Discharge Mode	Air Discharge								Contact Discharge								Performance Criterion	Result
	4		8		10		15		2		4		6		8			
Test Location	+	-	+	-	+	-	+	-	+	-	+	-	+	-	+	-	+	-
HCP	/	/	/	/	/	/	/	/	A	A	A	A	/	/	/	/	B	Pass
VCP	/	/	/	/	/	/	/	/	A	A	A	A	/	/	/	/		Pass
A1	A	A	A	A	/	/	/	/	/	/	/	/	/	/	/	/		Pass
A2	A	A	A	A	/	/	/	/	/	/	/	/	/	/	/	/		Pass
A3	A	A	A	A	/	/	/	/	/	/	/	/	/	/	/	/		Pass
A4	A	A	A	A	/	/	/	/	/	/	/	/	/	/	/	/		Pass
A5	A	A	A	A	/	/	/	/	/	/	/	/	/	/	/	/		Pass
<p>Note 1): Horizontal Coupling Plane (HCP) and Vertical Coupling plane (VCP).</p> <p>Note 2): “Cx” means Contact Point ,x=1~N,“Ax” means Air Point, x=1~N.</p> <p>Note 3): “A” stand for, No degradation in performance of the EUT was observed. “B” stand for, Degradation in performance of the EUT occurred during the application of the disturbance, after the test, EUT can self-recovered and operate as intended.</p>																		

7.2 RF FIELD STRENGTH IMMUNITY TEST						
Acceptable Performance Criterion:	A					
Test Level	3 V/m					
Test Distance	3 m					
Frequency Range	80MHz~6000MHz					
Polarity:	Horizontal & Vertical					
7.2.1 E.U.T. Operation						
Temperature:	26°C	Humidity:	54% RH	Atmospheric Pressure:	101	Kpa
Test Mode:	All Modes					
7.2.2 TEST PROCEDURE						
<p>The EUT and support equipment, which are placed on a table that is 0.8 meter above ground and the testing was performed in a fully-anechoic chamber.</p> <p>The testing distance from antenna to the EUT was 3 meters.</p> <p>The other condition as following manner:</p> <ol style="list-style-type: none"> The field strength level was 3V/m. The frequency range is swept from 80 MHz to 1000 MHz, & 1000MHz - 6000MHz with the signal 80%amplitude modulated with a 1kHz sine wave. The rate of sweep did not exceed 1.5x 10⁻³ decade/s. Where the frequency range is swept incrementally, the step size was 1% of fundamental. Sweep Frequency 900 MHz, with the Duty Cycle:1/8 and Modulation: Pulse 217 Hz(if applicable) The dwell time at each frequency shall be not less than the time necessary for the EUT to be able to respond. The test was performed with the EUT exposed to both vertically and horizontally polarized fields on each of the four sides. For the actual test configuration, please refer to the related Item –EUT Test Photos. 						

7.2.3 Test Specification

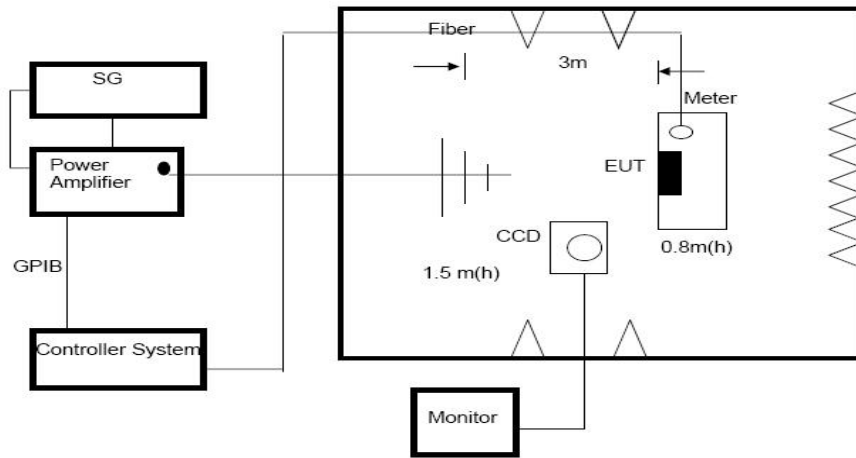

TABLE-TOP EQUIPMENT

The EUT installed in a representative system as described in section 7 of IEC/EN 61000-4-3 was placed on a non-conductive table 0.8 meters in height. The system under test was connected to the power and signal wire according to relevant installation instructions.

FLOOR-STANDING EQUIPMENT

The EUT installed in a representative system as described in section 7 of IEC/EN 61000-4-3 was placed on a non-conductive wood support 0.1 meters in height. The system under test was connected to the power and signal wire according to relevant installation instructions.

7.2.4 Measurement Data

Radiated Frequency Field Strength Susceptibility Results		
M/N:	Active 6	Test Result: <input checked="" type="checkbox"/> Pass <input type="checkbox"/> Fail
Test Voltage:	AC 230V/50Hz	Test date: 2023-07-19
Test Port	Enclosure	

Frequency	Level	Modulation	Antenna Polarization	EUT Face	Observations (Performance Criterion)	Result
80 MHz-6 GHz	3 V/m	1 kHz, 80 % Amp. Mod, 1 % increment, dwell time=3seconds	V	Front	A	Pass
			H		A	Pass
			V	Rear	A	Pass
			H		A	Pass
			V	Left	A	Pass
			H		A	Pass
			V	Right	A	Pass
			H		A	Pass
			V	Top	A	Pass
			H		A	Pass
			V	Bottom	A	Pass
			H		A	Pass

Note: "A" stand for, during test, operate as intended no loss of function, no degradation of performance, no unintentional transmissions and after test, no degradation of performance, no loss of function, no loss of stored data or user programmable functions.

Special conditions for EMC immunity tests

EUT operating Mode	PER during test(Worst)	PER Limit	Result
BT	5.17%	10%	Pass
WIFI 2.4G	2.81%	10%	Pass
GSM/GPRS/EGPRS 900 MHz, Traffic	4.02%	10%	Pass
UMTS/HSPA 900 MHz, Traffic	3.95%	10%	Pass
LTE BAND 1 Traffic	1.22%	10%	Pass
LTE BAND 3 Traffic	1.81%	10%	Pass
LTE BAND 8 Traffic	2.39%	10%	Pass
LTE BAND 20 Traffic	2.86%	10%	Pass
LTE BAND 38 Traffic	2.27%	10%	Pass
LTE BAND 40 Traffic	2.22%	10%	Pass
GPS&GALILEO&BEIDOU&GLONASS	1.06%	10%	Pass

7.3 ELECTRICAL FAST TRANSIENT/BURST IMMUNITY TEST

Acceptable Performance Criterion:	B
Test Level:	0.5, 1.0, kV on AC Line 0.5 kV on DC line or signal or wired network Line
Repetition Frequency:	5 kHz and 100KHz
Burst Duration:	300 ms
Test Duration:	1 minutes for each level & polarity

7.3.1 E.U.T. Operation

Temperature:	25°C	Humidity:	50% RH	Atmospheric Pressure:	101	Kpa
Test Mode:	All Modes					

7.3.2 Test specification

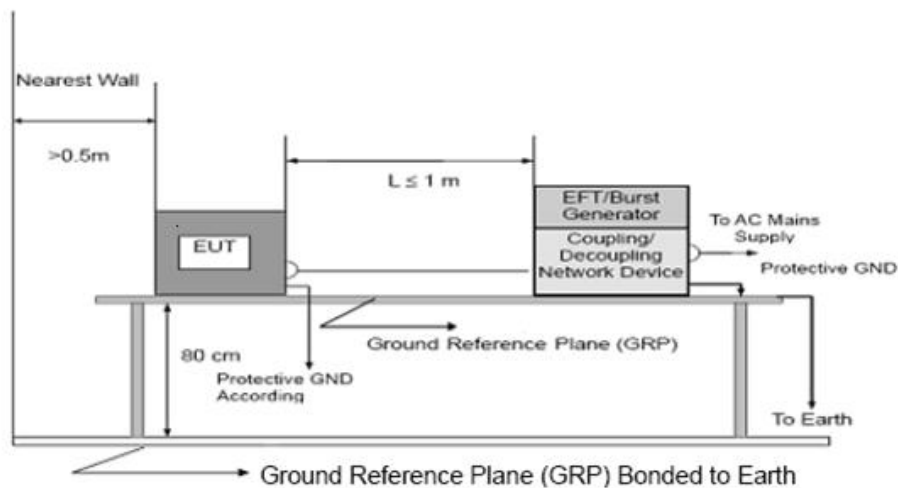

EUT was placed on a metal ground reference plane and was insulated from it by a wooden support which is 0.1m thick. The ground reference plane is connected to the protective earth. The test generator and the coupling/decoupling network were placed directly on, and bonded to the ground reference plane.

7.3.3 Measurement Data

Test Record

Electrical Fast Transient/Burst Result											
M/N:		Active 6				Test Result: <input checked="" type="checkbox"/> Pass <input type="checkbox"/> Fail					
Test Voltage:		AC 230V/50Hz				Test date: 2023.07.19					
Test Signal		Rise time: 5ns, Duration: 50ns, repetition rate : <input checked="" type="checkbox"/> 5KHz <input type="checkbox"/> 100KHz									
Coupling Line		Test level (kV)								Performance Criterion	Result
		0.5		1		2		4			
		+	-	+	-	+	-	+	-		
AC line	L	A	A	A	A	/	/	/	/	B	Pass
	N	A	A	A	A	/	/	/	/		Pass
	L+N	A	A	A	A	/	/	/	/		Pass
	L+PE	/	/	/	/	/	/	/	/		N/A
	N+PE	/	/	/	/	/	/	/	/		N/A
	L+N+PE	/	/	/	/	/	/	/	/		N/A
Wired network Line	RJ45	/	/	/	/	/	/	/	/		Pass
Wired network	xDSL	/	/	/	/	/	/	/	/	N/A	
Signal Line	/	/	/	/	/	/	/	/	/	N/A	
DC Line	/	/	/	/	/	/	/	/	/	N/A	

Note: "A" stand for, No degradation in performance of the EUT was observed.
 "B" stand for, Degradation in performance of the EUT occurred during the application of the disturbance, after the test, EUT can self-recovered and operate as intended.

7.4 SURGE IMMUNITY TEST

Acceptable Performance Criterion:	B
Test Level:	0.5, 1kV Line to Neutral; 0.5, 1kV , 2kV Line to earth; 0.5, 1kV Wired network Line
Polarity:	Positive & Negative
Generator source impedance:	2 Ω;
Trigger Mode:	Internal
No. of surges:	5 positive & 5 negative at 0°, 90°, 180°, 270°.

7.4.1 E.U.T. Operation

Temperature:	25°C	Humidity:	50% RH	Atmospheric Pressure:	101	Kpa
Test Mode:	All Modes					

7.4.2 Test specification

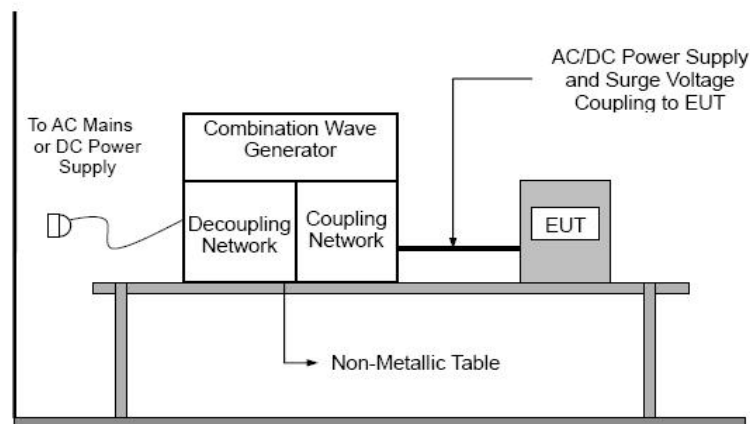

EUT was placed on a wooden table which is 0.8m above the ground and operated in the mode as mentioned above. The power cord between the EUT and the coupling/decoupling network was bundled so as to make it less than 2 m in length.

7.4.3 Measurement Data

Test Record

Surge Immunity Test Result												
M/N:		Active 6				Test Result: <input checked="" type="checkbox"/> Pass <input type="checkbox"/> Fail						
Test Voltage:		AC 230V/50Hz				Test date: 2023.07.19						
Test Signal		<input checked="" type="checkbox"/> 1.2/50 μ s <input type="checkbox"/> 10/700 μ s Interval: <u>60</u> seconds Pluse: <u>10</u> times										
Coupling Line		Test level								Performance Criterion	Result	
		0.5 kV		1 kV		2 kV		4 kV				
		+	-	+	-	+	-	+	-			
AC line	L-N	0°	A	A	A	A	/	/	/	/	B	Pass
		90°	A	A	A	A	/	/	/	/		Pass
		180°	A	A	A	A	/	/	/	/		Pass
		270°	A	A	A	A	/	/	/	/		Pass
	L-P E	0°	/	/	/	/	/	/	/	/		N/A
		90°	/	/	/	/	/	/	/	/		N/A
		180°	/	/	/	/	/	/	/	/		N/A
		270°	/	/	/	/	/	/	/	/		N/A
	N-PE	0°	/	/	/	/	/	/	/	/		N/A
		90°	/	/	/	/	/	/	/	/		N/A
		180°	/	/	/	/	/	/	/	/		N/A
		270°	/	/	/	/	/	/	/	/		N/A
Wired network Line	RJ 45	/	/	/	/	/	/	/	/		Pass	
Note: "A" stand for, No degradation in performance of the EUT was observed. "B" stand for, Degradation in performance of the EUT occurred during the application of the disturbance, after the test, EUT can self-recovered and operate as intended.												

7.5 CONDUCTED DISTURBANCE IMMUNITY TEST

Acceptable Performance Criterion:	A
Test Level	3 V
Frequency Range	0.15MHz~80MHz

7.5.1 E.U.T. Operation

Temperature:	23°C	Humidity:	55% RH	Atmospheric Pressure:	101	Kpa
Test Mode:	All Modes					

7.5.2 Test specification

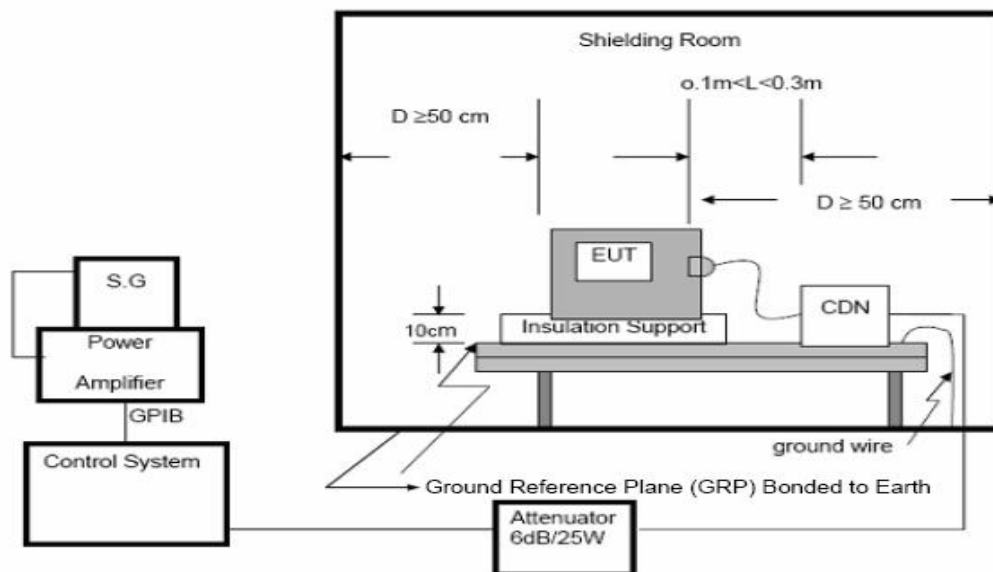

The equipment to be tested was placed on an insulating support of 0,1m height above a ground reference Plane. The minimum distance between the EUT and all other conductive structures, except the ground reference plane is more than 0.5m. All relevant cables were provided with the appropriate coupling and decoupling devices at a distance between 0.1m and 0.3m from the projected geometry of the EUT.

7.5.3 Measurement Data

Test Record

Injected Currents Susceptibility Measurement Result			
M/N:	Active 6	Test Result: <input checked="" type="checkbox"/> Pass <input type="checkbox"/> Fail	
Test Voltage:	AC 230V/50Hz	Test date: 2023.07.19	
Test Port	<input checked="" type="checkbox"/> AC Port <input type="checkbox"/> Wired network <input type="checkbox"/> Signal Line <input type="checkbox"/> DC Port		
Operating Mode	All Modes		
Test Level (V)	<u>3</u> V(r.m.f) (unmodulated)	Criterion	A

Test Ports (Mode)	Freq. Range (MHz)	Field Strength	Observation	Observations (Performance Criterion)	Results
Input/ Output AC. Power Port	0.15 ---80	3V(rms) AM Modulated 1000Hz, 80%	CT, CR	A	P
Wired network ports	0.15 ---80		CT, CR	A	P
Input/ Output DC. Power Port	0.15 --- 80		N/A	N/A	N/A
Signal Line	0.15 --- 80		N/A	N/A	N/A

Note: "A" stand for, during test, operate as intended no loss of function, no degradation of performance, no unintentional transmissions and after test, no degradation of performance, no loss of function, no loss of stored data or user programmable functions.

Special conditions for EMC immunity tests

EUT operating Mode	PER during test(Worst)	PER Limit	Result
BT	2.13%	10%	Pass
WIFI 2.4G	1.82%	10%	Pass
GSM/GPRS/EGPRS 900 MHz, Traffic	2.93%	10%	Pass
UMTS/HSPA 900 MHz, Traffic	1.55%	10%	Pass
LTE BAND 1 Traffic	2.01%	10%	Pass
LTE BAND 3 Traffic	2.37%	10%	Pass
LTE BAND 8 Traffic	1.92%	10%	Pass
LTE BAND 20 Traffic	2.33%	10%	Pass
LTE BAND 38 Traffic	2.87%	10%	Pass
LTE BAND 40 Traffic	3.02%	10%	Pass
GPS&GALILEO&BEIDOU &GLONASS	2.03%	10%	Pass

7.6 VOLTAGE DIPS AND INTERRUPTIONS IMMUNITY TEST

Acceptable Performance Criterion:	B & C
Test Level:	<5% of U_T (Supply Voltage) for 0.5 and 250 Periods
	70 % of U_T (Supply Voltage) for 25 Periods
No. of Dips / Interruptions:	3 per Level

7.6.1 E.U.T. Operation

Temperature:	25°C	Humidity:	50% RH	Atmospheric Pressure:	101	Kpa
Test Mode:	All Modes					

7.6.2 Test specification

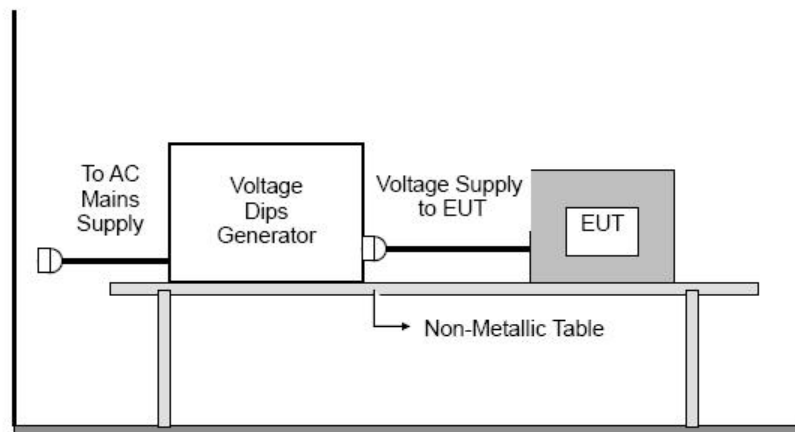

EUT connected to the test generator with the shortest power supply cable as specified by the EUT manufacturer. The rated voltage of the EUT was used as the basis for voltage test level specification. After each group of tests, a full functional check was performed.

7.6.3 Measurement Data

Test Record

Voltage Dips And Interruptions Test Result						
M/N:	Active 6			Test Result: <input checked="" type="checkbox"/> Pass <input type="checkbox"/> Fail		
Test Voltage:	AC 230V/50Hz			Test date: 2023.07.19		
Test Port	<input checked="" type="checkbox"/> AC Port					
Level (%U _T)	Interruption & Dips (%U _T)	Duration (Cyc)	Phase	Test result	Criterion	Result
70	30	25	0	B	C	Pass
0	100	0.5	0	A	B	Pass
0	100	1.0	0	A	B	Pass
0	100	250	0	B	C	Pass
<p>Note: "A" stands for, No degradation in performance of the EUT was observed. "B" stands for, Degradation in performance of the EUT occurred during the application of the disturbance, after the test, EUT can self-recovered and operate as intended. "C" stands for, Loss of function of the EUT occurred during the application of the disturbance, after the test, EUT can self-recovered or restored by manually and operate as intended.</p>						

8 TEST SETUP PHOTOS OF THE EUT

Radiated Emission

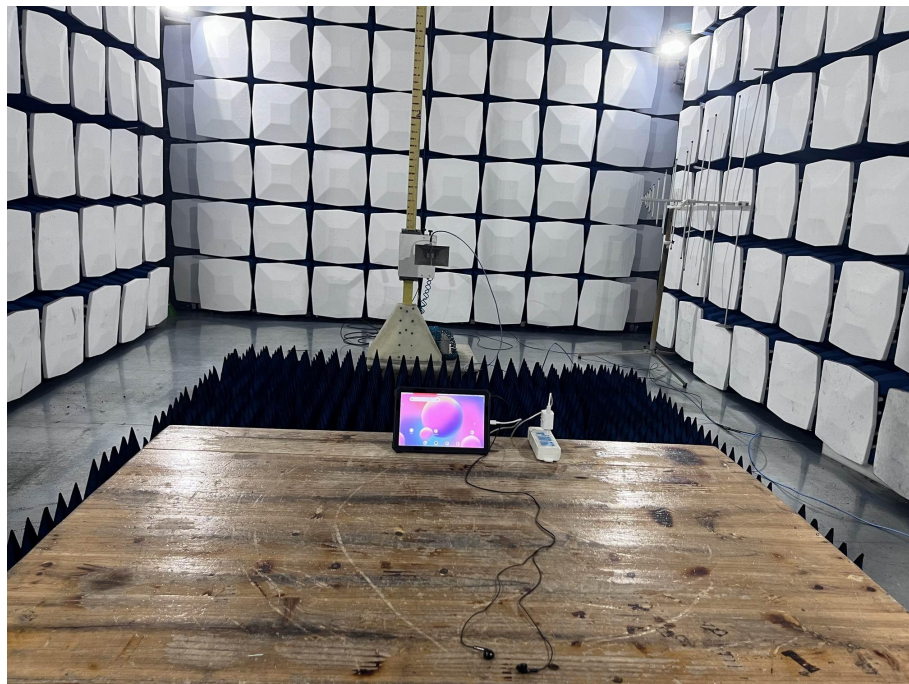
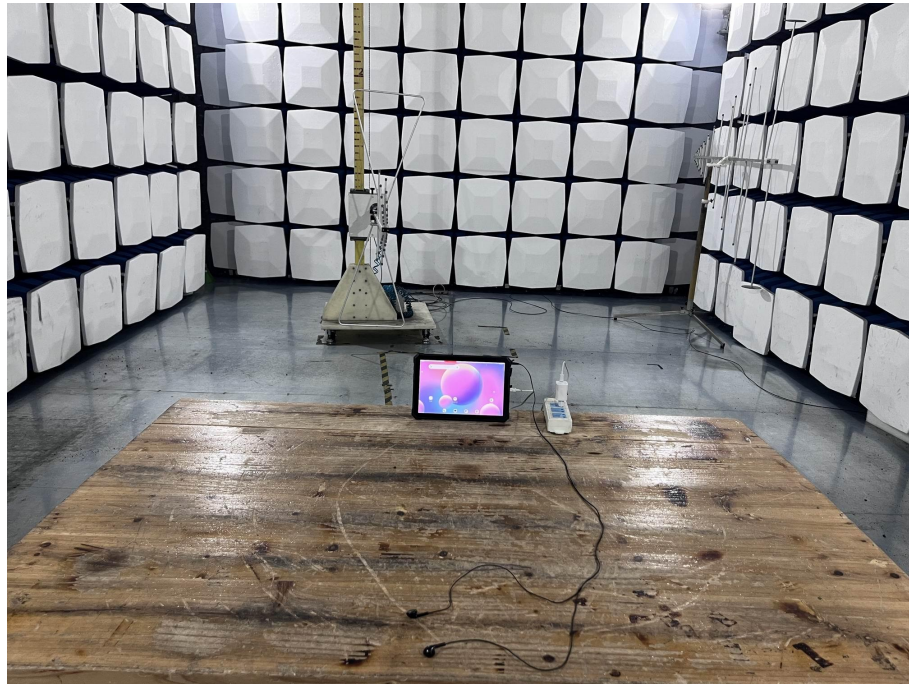

Conducted Emission(AC Mains)



Harmonic Current/ Voltage Fluctuation and Flicker



Electrostatic Discharge



RF Electromagnetic Field

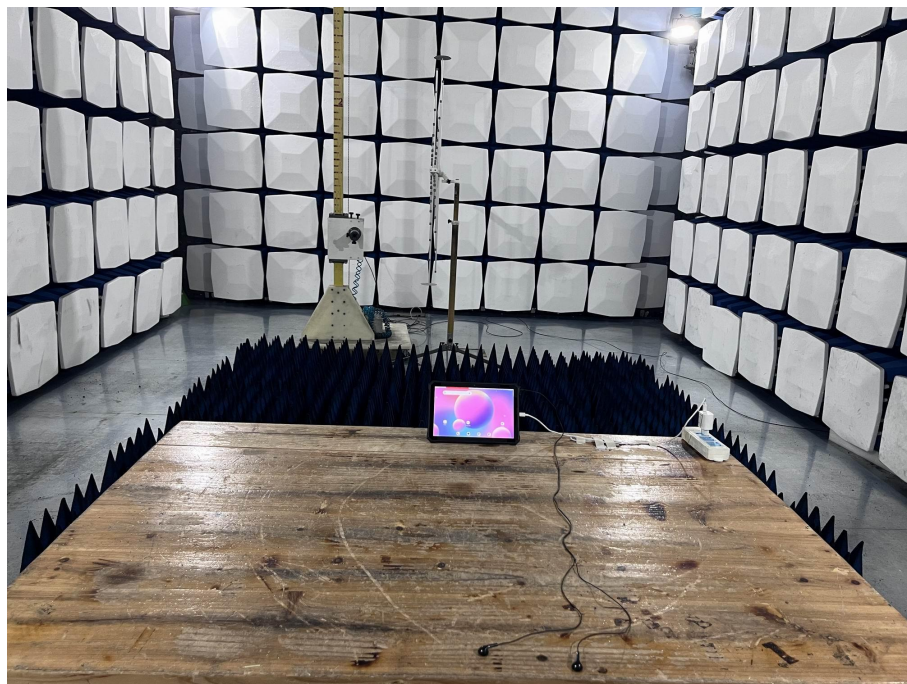

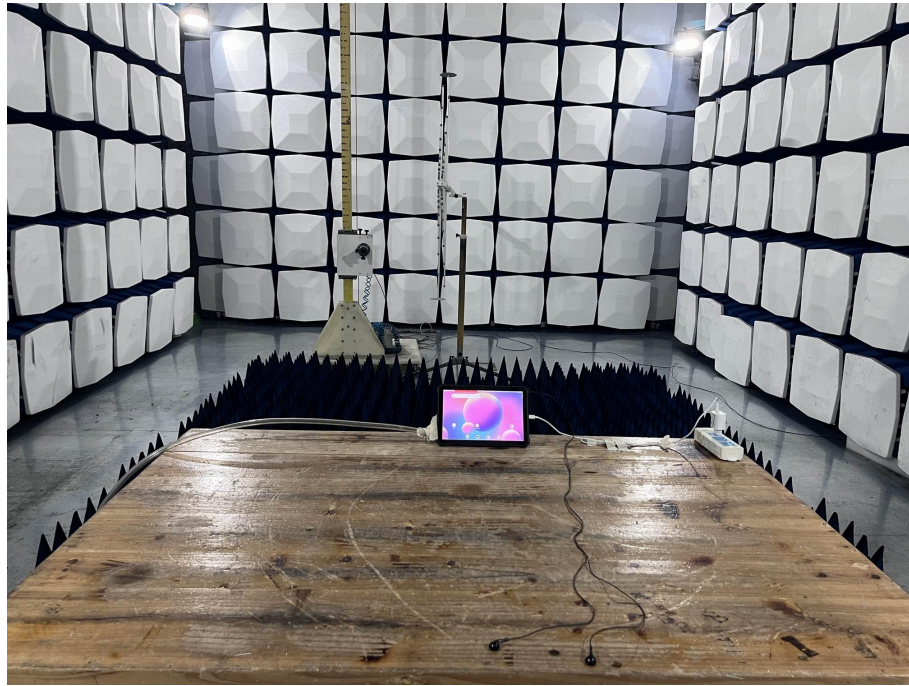

RF Common Mode 0,15 MHz to 80 MHz

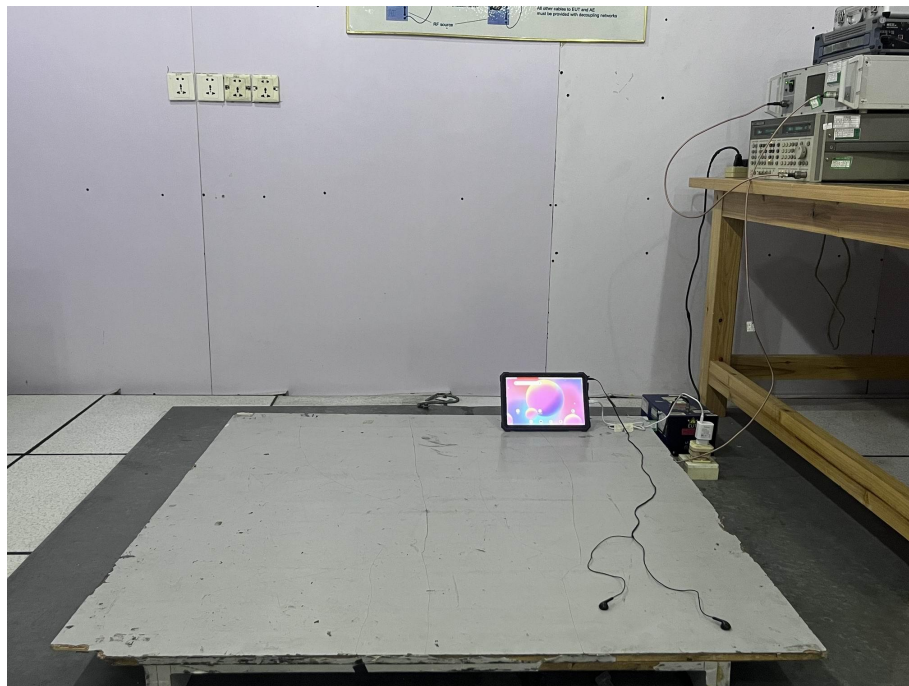

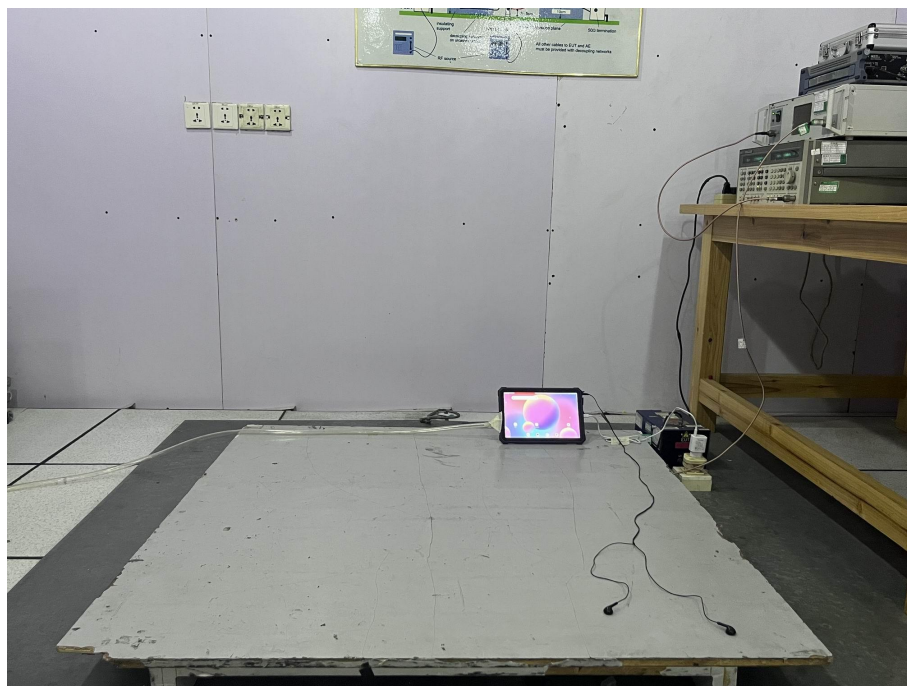

Fast Transients Common Mode & Surge & DIPS

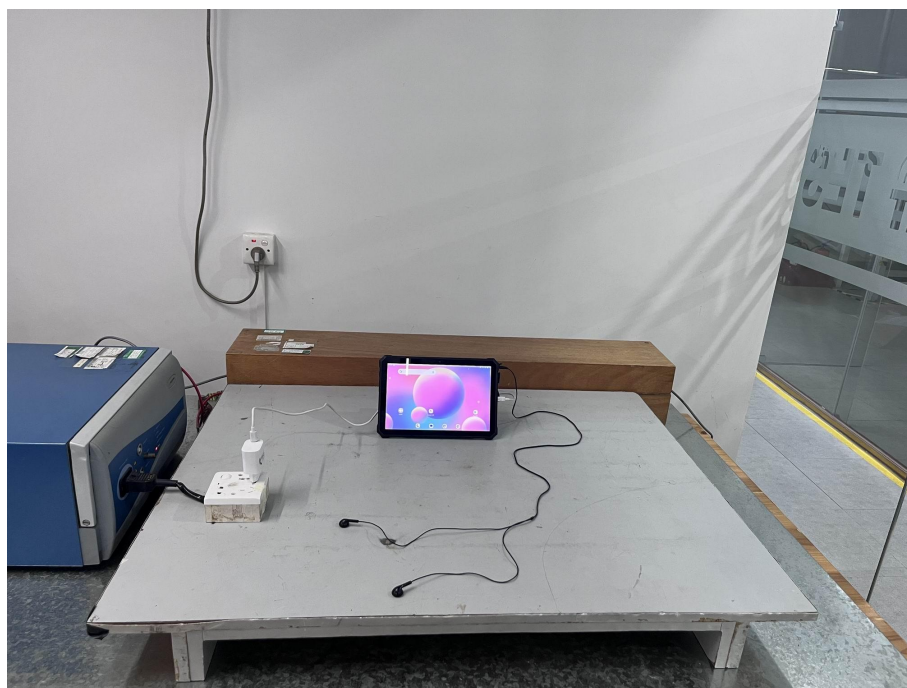

9 External And Internal Photos of The EUT

Please refer to the appendix for details

****End of the report****