

EMC Test Report

Client Information:

Applicant: DOKE COMMUNICATION (HK) LIMITED
Applicant add.: RM 1902 EASEY COMM BLDG 253-261 HENNESSY ROAD WANCHAI HK CHINA

Product Information:

Product Name: Tablet PC
Model No.: Active 8
Serial Model: N/A
Brand Name: Blackview
Standards: ETSI EN 301 489-1 V2.2.3 (2019-11)
ETSI EN 301 489-17 V3.2.4 (2020-09)
ETSI EN 301 489-19 V2.1.1(2019-04)
ETSI EN 301 489-52 V1.1.2 (2020-12)
EN 55032:2015+A1:2020; EN 55035:2017+A11:2020
EN IEC 61000-3-2:2019+A1:2021; EN 61000-3-3:2013+A1: 2019

Prepared By:

Dongguan Yaxu (AiT) Technology Limited

Add. : No.22, Jinqianling Third Street, Jitigang, Huangjiang,
Dongguan, Guangdong, China

Date of Receipt: 2023.05.25 Date of Test: 2022.05.26~2023.06.12
Date of Issue: 2023.06.13 Test Result: Pass

This device has been tested and found to comply with the stated standard(s), which is (are) required by the council directive of 2014/53/EU and indicated in the test report and are applicable only to the tested sample identified in the report.

Note: This report shall not be reproduced except in full, without the written approval of Dongguan Yaxu (AiT) Technology Limited, this document may be altered or revised by Dongguan Yaxu (AiT) Technology Limited, personal only, and shall be noted in the revision of the document. This test report must not be used by the client to claim product endorsement.

Reviewed by: Simba Huang
Simba Huang

Approved by: Seal-Chen
Seal.chen





REPORT REVISE RECORD

| Report Version | Revise Time | Issued Date | Valid Version | Notes |
|----------------|-------------|-------------|---------------|-----------------|
| V1.0 | / | 2023.06.13 | Valid | Initial Release |

1 Contents

| | Page |
|--|-----------|
| 1 CONTENTS | 3 |
| 2 TEST SUMMARY | 5 |
| 2.1 PERFORMANCE CRITERIA | 7 |
| 2.2 MONITORING EUT IN IMMUNITY TEST | 8 |
| 2.2.1 Monitoring for Continuous Phenomena Applied to the EUT | 8 |
| 2.3 MEASUREMENT UNCERTAINTY | 11 |
| 3 TEST FACILITY | 12 |
| 3.1 DEVIATION FROM STANDARD | 12 |
| 3.2 ABNORMALITIES FROM STANDARD CONDITIONS | 12 |
| 4 GENERAL INFORMATION | 13 |
| 4.1 GENERAL DESCRIPTION OF EUT | 13 |
| 4.2 EUT TEST MODE | 14 |
| 4.3 DESCRIPTION OF TEST SETUP | 16 |
| 4.4 TEST PERIPHERAL LIST | 17 |
| 4.5 EUT PERIPHERAL LIST | 17 |
| 5 EQUIPMENTS LIST FOR ALL TEST ITEMS | 18 |
| 6 EMISSION TEST RESULTS | 21 |
| 6.1 CONDUCTED EMISSION(AC MAINS) MEASUREMENT | 21 |
| 6.1.1 E.U.T. Operation | 21 |
| 6.1.2 Test Specification | 21 |
| 6.1.3 Measurement Data | 22 |
| 6.2 CONDUCTED EMISSION(WIRED NETWORK PORTS) MEASUREMENT | 26 |
| 6.2.1 E.U.T. Operation | 26 |
| 6.2.2 Test Specification | 26 |
| 6.2.3 Measurement Data | 27 |
| 6.3 RADIATED EMISSION MEASUREMENT | 28 |
| 6.3.1 E.U.T. Operation | 28 |
| 6.3.2 Test Specification | 29 |
| 6.3.3 Measurement Data | 30 |
| 6.4 HARMONICS | 34 |
| 6.4.1 E.U.T. Operation | 34 |
| 6.4.2 Test specification | 34 |
| 6.4.3 Measurement Data | 35 |
| 6.5 VOLTAGE CHANGES, VOLTAGE FLUCTUATIONS AND FLICKER | 36 |
| 6.5.1 E.U.T. Operation | 36 |
| 6.5.2 Test specification | 36 |
| 6.5.3 Measurement Data | 37 |

| | |
|---|-----------|
| 7 IMMUNITY TEST RESULTS | 38 |
| 7.1 ELECTROSTATIC DISCHARGE IMMUNITY TEST | 38 |
| 7.1.1 E.U.T. Operation | 38 |
| 7.1.2 Test Specification | 38 |
| 7.1.3 Measurement Data | 39 |
| 7.2 RF FIELD STRENGTH IMMUNITY TEST | 40 |
| 7.2.1 E.U.T. Operation | 40 |
| 7.2.2 TEST PROCEDURE | 40 |
| 7.2.3 Test Specification | 41 |
| 7.2.4 Measurement Data | 41 |
| 7.3 ELECTRICAL FAST TRANSIENT/BURST IMMUNITY TEST | 43 |
| 7.3.1 E.U.T. Operation | 43 |
| 7.3.2 Test specification | 43 |
| 7.3.3 Measurement Data | 44 |
| 7.4 SURGE IMMUNITY TEST | 45 |
| 7.4.1 E.U.T. Operation | 45 |
| 7.4.2 Test specification | 45 |
| 7.4.3 Measurement Data | 46 |
| 7.5 CONDUCTED DISTURBANCE IMMUNITY TEST | 47 |
| 7.5.1 E.U.T. Operation | 47 |
| 7.5.2 Test specification | 47 |
| 7.5.3 Measurement Data | 48 |
| 7.6 VOLTAGE DIPS AND INTERRUPTIONS IMMUNITY TEST | 50 |
| 7.6.1 E.U.T. Operation | 50 |
| 7.6.2 Test specification | 50 |
| 7.6.3 Measurement Data | 51 |
| 8 TEST SETUP PHOTOS OF THE EUT | 52 |
| 9 EXTERNAL AND INTERNAL PHOTOS OF THE EUT | 57 |

2 Test Summary

| Emission Measurement | | |
|---|--|------|
| Radiated Emission | ETSI EN 301 489-1 V2.2.3 (2019-11) ETSI EN 301 489-17 V3.2.4 (2020-09) ETSI EN 301 489-52 V1.1.2 (2020-12) ETSI EN 301 489-19 V2.1.1(2019-04) EN 55032:2015+A1:2020 | PASS |
| Conducted Emission(AC Mains) | ETSI EN 301 489-1 V2.2.3 (2019-11) ETSI EN 301 489-17 V3.2.4 (2020-09) ETSI EN 301 489-19 V2.1.1(2019-04) ETSI EN 301 489-52 V1.1.2 (2020-12) EN 55032:2015+A1:2020 | PASS |
| Conducted Emission(Wired network ports) | ETSI EN 301 489-1 V2.2.3 (2019-11) ETSI EN 301 489-17 V3.2.4 (2020-09) ETSI EN 301 489-19 V2.1.1(2019-04) ETSI EN 301 489-52 V1.1.2 (2020-12) EN 55032:2015+A1:2020 | N/A |
| Harmonic Current Emissions | ETSI EN 301 489-1 V2.2.3 (2019-11) ETSI EN 301 489-17 V3.2.4 (2020-09) ETSI EN 301 489-19 V2.1.1(2019-04) ETSI EN 301 489-52 V1.1.2 (2020-12) EN IEC 61000-3-2:2019+A1:2021 | PASS |
| Voltage Fluctuations and Flicker | ETSI EN 301 489-1 V2.2.3 (2019-11) ETSI EN 301 489-3 V2.1.1 (2019-03) ETSI EN 301 489-17 V3.2.4 (2020-09) ETSI EN 301 489-19 V2.1.1(2019-04) ETSI EN 301 489-52 V1.1.2 (2020-12) EN 61000-3-3:2013+A1: 2019 | PASS |
| Immunity Measurement | | |
| Electrostatic Discharge | ETSI EN 301 489-1 V2.2.3 (2019-11) ETSI EN 301 489-17 V3.2.4 (2020-09) ETSI EN 301 489-52 V1.1.2 (2020-12) EN 55035:2017+A11:2020 | PASS |
| RF Electromagnetic Field | ETSI EN 301 489-1 V2.2.3 (2019-11) ETSI EN 301 489-17 V3.2.4 (2020-09) ETSI EN 301 489-52 V1.1.2 (2020-12) EN 55035:2017+A11:2020 | PASS |
| Fast Transients Common Mode | ETSI EN 301 489-1 V2.2.3 (2019-11) ETSI EN 301 489-17 V3.2.4 (2020-09) ETSI EN 301 489-19 V2.1.1(2019-04) ETSI EN 301 489-52 V1.1.2 (2020-12) EN 55035:2017+A11:2020 | PASS |
| RF Common Mode 0,15 MHz to 80 MHz | ETSI EN 301 489-1 V2.2.3 (2019-11) ETSI EN 301 489-17 V3.2.4 (2020-09) ETSI EN 301 489-19 V2.1.1(2019-04) ETSI EN 301 489-52 V1.1.2 (2020-12) EN 55035:2017+A11:2020 | PASS |
| Voltage Dips and Interruptions | ETSI EN 301 489-1 V2.2.3 (2019-11) ETSI EN 301 489-17 V3.2.4 (2020-09) ETSI EN 301 489-19 V2.1.1(2019-04) ETSI EN 301 489-52 V1.1.2 (2020-12) EN 55035:2017+A11:2020 | PASS |

| | | |
|--------|--|------|
| Surges | ETSI EN 301 489-1 V2.2.3 (2019-11) ETSI EN 301 489-17 V3.2.4 (2020-09) ETSI EN 301 489-19 V2.1.1(2019-04) ETSI EN 301 489-52 V1.1.2 (2020-12) EN 55035:2017+A11:2020 | PASS |
|--------|--|------|

Remark: The measurement uncertainty is not included in the test result.

2.1 Performance criteria

■ Performance Criterion of EN55035

Criterion A: The equipment shall continue to operate as intended without operator intervention. No degradation of performance or loss of function is allowed below a performance level specified by the manufacturer when the equipment is used as intended.

Criterion B: After the test, the equipment shall continue to operate as intended without operator intervention. No degradation of performance or loss of function is allowed, after the application of the phenomena below a performance level specified by the manufacturer, when the equipment is used as intended.

Criterion C: Loss of function is allowed, provided the function is self-recoverable, or can be restored by the operation of the controls by the user in accordance with the manufacturer's instructions.

2.2 Monitoring EUT in Immunity Test

2.2.1 Monitoring for Continuous Phenomena Applied to the EUT

According to **ETSI EN 301 489-3** standard, the general performance criteria are as follows:

| EN 301 489-3 PERFORMANCE CRITERIA | | |
|---|--|---|
| Criteria | During Test | After Test |
| A | Operate as intended No loss of function No unintentional responses | Operate as intended No loss of function No degradation of performance No loss of stored data or user programmable functions |
| B | May show loss of function No unintentional responses | Operate as intended Lost function(s) shall be self-recoverable No degradation of performance No loss of stored data or user programmable functions |
| <ul style="list-style-type: none"> • performance criterion A applies for immunity tests with phenomena of a continuous nature; • performance criterion B applies for immunity tests with phenomena of a transient nature. | | |
| <p>Where "operate as intended" or "no loss of function" is specified, the EUT shall demonstrate correct functioning as described in EN 301 489-3 clause 5.</p> <p>Where the EUT has more than one mode of operation, an unplanned transition from one mode to another is considered as an unintentional response. The EUT shall be tested in sufficient modes to confirm there are no such unintentional responses.</p> | | |

According to **ETSI EN 301 489-19** standard, the general performance criteria are as follows:

| EN 301 489-19 PERFORMANCE CRITERIA_GPS |
|--|
| <p>Performance criteria for Continuous phenomena applied to ROMES and ROGNSS receivers (CR) For the EUT, excluding spot frequency tests as part of the immunity test with radiated RF electromagnetic fields (see ETSI EN 301 489-1 [1], clause 9.2):</p> <ul style="list-style-type: none"> • the general performance criteria set out in clause 6.1; • during the test no false calls shall occur; • at the conclusion of the test comprising the series of individual exposures, the EUT shall operate as intended with no loss of functions or stored data (messages), as declared by the manufacturer. |
| <p>Performance criteria for Transient phenomena applied to ROMES and ROGNSS receivers (TR) For the EUT:</p> <ul style="list-style-type: none"> • the general performance criteria set out in clause 6.1; • during the test no false calls shall occur; • at the conclusion of the test comprising the series of individual exposures, the EUT shall operate as intended with no loss of function and/or stored data (messages), as declared by the manufacturer. |

According to ETSI EN 301 489-17 standard, the general performance criteria are as follows:

| EN 301 489-17 PERFORMANCE CRITERIA_ Bluetooth/WLAN | | |
|---|--|---|
| Criteria | During Test | After Test (i.e. as a result of the application of the test) |
| A | Shall operate as intended. (see note). Shall be no loss of function. Shall be no unintentional transmissions. | Shall operate as intended. Shall be no degradation of performance. Shall be no loss of function. Shall be no loss of critical stored data. |
| B | May be loss of function. | Functions shall be self-recoverable. Shall operate as intended after recovering. Shall be no loss of critical stored data. |
| C | May be loss of function. | Functions shall be recoverable by the operator. Shall operate as intended after recovering. Shall be no loss of critical stored data. |
| <p>The performance criteria A shall apply for continuous phenomena. The performance criteria B shall apply for transient phenomena, except for voltage dips greater than or equal to 100 ms and voltage interruptions of 5 000 ms duration, for which performance criteria C shall apply. Where the EUT is a transmitter in standby mode or receive mode, unintentional transmission shall not occur during the test.</p> | | |
| <p>Note: Operate as intended during the test allows a level of degradation in accordance with the Minimum performance level.</p> | | |
| Minimum performance level | | |
| <p>For equipment that supports a PER or FER, the minimum performance level shall be a PER or FER less than or equal to 10 %. For equipment that does not support a PER or a FER, the minimum performance level shall be no loss of the wireless transmission function needed for the intended use of the equipment.</p> | | |

According to ETSI EN 301 489-52 standard, the general performance criteria are as follows:

| CLAUSE 6 OF EN 301 489-52_(GSM/WCDMA/LTE/NR) | |
|--|--|
| Criteria | Performance criteria |
| CT/CR | <p>Performance criteria for Continuous phenomena applied to Transmitters (CT) A communication link shall be established at the start of the test, and maintained during the test, see clauses 4.2.3 and 4.2.4. NOTE: When there is a high_level background noise present the filter bandwidth can be reduced down to a minimum of 40 Hz. At the conclusion of the test, the EUT shall operate as intended with no loss of user control functions or stored data, and the communication link shall have been maintained. In addition to confirming the above performance during a call, the test shall also be performed in idle mode, and the transmitter shall not unintentionally operate.</p> |
| | <p>Performance criteria for Continuous phenomena applied to Receivers (CR) A communications link shall be established at the start of the test, see appropriate clauses 4.2 to 4.2.6. During the test, the RXQUAL of the downlink shall not exceed the value of three, measured during each individual exposure in the test sequence. During the test, the downlink speech output level shall be at least 35 dB less than the previously recorded reference levels, when measured through an audio band pass filter of width 200 Hz, centered on 1 kHz (audio breakthrough check).</p> |

| | |
|--------------|--|
| | <p>NOTE: When there is a high level background noise present the filter bandwidth can be reduced down to a minimum of 40 Hz.</p> <p>At the conclusion of the test, the EUT shall operate as intended with no loss of user control functions or stored data, and the communication link shall have been maintained.</p> |
| <p>TT/TR</p> | <p>Performance criteria for Transient phenomena applied to Transmitters (TT)</p> <p>A communications link shall be established at the start of the test, see appropriate clauses 4.2 to 4.2.4.</p> <p>At the conclusion of each exposure the EUT shall operate with no user noticeable loss of the communication link.</p> <p>At the conclusion of the total test comprising the series of individual exposures, the EUT shall operate as intended with no loss of user control functions or stored data, as declared by the manufacturer, and the communication link shall have been maintained.</p> <p>In addition to confirming the above performance during a call, the test shall also be performed in idle mode, and the transmitter shall not unintentionally operate.</p> |
| | <p>Performance criteria for Transient phenomena applied to Receivers (TR)</p> <p>A communications link shall be established at the start of the test, see appropriate clauses 4.2. to 4.2.6.</p> <p>At the conclusion of each exposure the EUT shall operate with no user noticeable loss of the communication link.</p> <p>At the conclusion of the total test comprising the series of individual exposures, the EUT shall operate as intended with no loss of user control functions or stored data, as declared by the manufacturer, and the communication link shall have been maintained.</p> <p>Performance criteria for ancillary equipment tested on a standard basis</p> <p>The provision of ETSI EN 301 489-1 [1], clause 6.4 shall apply.</p> |

Note:

For data transmission, the EUT was assessed in the following methods:

For WCDMA testing, the BER (as referred in TS 134 109 [9]) is used, it shall not exceed 0.1% during the test sequence.

For LTE testing, the throughput (as referred in TS 134 109 [9]) is used, it shall not exceed 0.1% during the test sequence.

Note: All test modes have been tested during the test.

2.3 Measurement Uncertainty

The report uncertainty of measurement $y \pm U$, where expanded uncertainty U is based on a standard uncertainty Multiplied by a coverage factor of $k=2$, providing a level of confidence of approximately 95% .

| No. | Item | Frequency Range | U , Value |
|-----|-------------------------------|-----------------|-----------|
| 1 | Power Line Conducted Emission | 150KHz~30MHz | 1.20 dB |
| 2 | Disturbance Power Emission | 30MHz~300MHz | 2.96 dB |
| 3 | Radiated Emission Test | 30MHz~1GHz | 3.75 dB |
| 4 | Radiated Emission Test | 1GHz~18GHz | 3.88 dB |

3 Test Facility

The test facility is recognized, certified or accredited by the following organizations:

CNAS- Registration No: L6177

Dongguan Yaxu (AiT) technology Limited is accredited to ISO/IEC 17025:2017 general Requirements for the competence of testing and calibration laboratories (CNAS-CL01 Accreditation Criteria for the competence of testing and calibration laboratories) on April 18, 2022

FCC-Registration No.: 703111 Designation Number: CN1313

Dongguan Yaxu (AiT) technology Limited has been registered and fully described in a report filed with the (FCC) Federal Communications Commission. The acceptance letter from the FCC is maintained in our files.

IC —Registration No.: 6819A CAB identifier: CN0122

The 3m Semi-anechoic chamber of Dongguan Yaxu (AiT) technology Limited has been registered by Certification and Engineering Bureau of Industry Canada for radio equipment testing with Registration No.: 6819A

A2LA-Lab Cert. No.: 6317.01

Dongguan Yaxu (AiT) technology Limited has been accredited by A2LA for technical competence in the field of electrical testing, and proved to be in compliance with ISO/IEC 17025: 2017 General Requirements for the Competence of Testing and Calibration Laboratories and any additional program requirements in the identified field of testing.

3.1 Deviation from Standard

None

3.2 Abnormalities from Standard Conditions

None

4 General Information

4.1 General Description of EUT

| | |
|------------------------------|---|
| Manufacturer: | Shenzhen DOKE Electronic Co., Ltd |
| Manufacturer Address: | 801, Building3, 7th Industrial Zone, Yulv Community, Yutang Road, Guangming District, Shenzhen, China |
| EUT Name: | Tablet PC |
| Model No: | Active 8 |
| Serial Model: | N/A |
| Brand Name: | Blackview |
| Difference Description | N/A |
| Radio parts supported | <input checked="" type="checkbox"/> GSM <input checked="" type="checkbox"/> UMTS <input checked="" type="checkbox"/> LTE <input checked="" type="checkbox"/> GPS&GALILEO&BEIDOU&GLONASS <input checked="" type="checkbox"/> BLUETOOTH <input checked="" type="checkbox"/> 2.4GWIFI <input checked="" type="checkbox"/> EGPRS |
| H/W No.: | DK051-T616-V1.0 |
| S/W No.: | Active8_EEA_T30_V1.0 |
| Adapter: | Model:HJ-C6-33-EU Input:100-240V 50/60Hz 0.35A Output: 5.0V 3.0A 15W;9V 3A 27W;12V 2.5A 30W; 15V 2A 30W ;20V 1.5A 30W; PPS 3.3V-11V 3A 33W |
| Battery: | 3.87V 22000mAh |

4.2 EUT Test Mode

| | |
|---|---|
| MODE 1 OPERATING MODE | Specification A: GSM 900 Specification: MS + Battery + Adapter Specification B: DCS 1800 Specification: MS + Battery + Adapter Specification C: UMTS 2100 Specification: MS + Battery + Adapter Specification D: UMTS 900 Specification: MS + Battery + Adapter Specification E: GPRS 900 Specification: MS + Battery + Adapter Specification F: GPRS 1800 Specification: MS + Battery + Adapter Specification G: EGPRS 900 Specification: MS + Battery + Adapter Specification H: EGPRS 1800 Specification: MS + Battery + Adapter Specification I: HSPA 2100 Specification: MS + Battery + Adapter Specification J: HSPA 900 Specification: MS + Battery + Adapter Specification K: LTE band 1 Specification: MS + Battery + Adapter Specification L: LTE band 3 Specification: MS + Battery+ Adapter Specification M: LTE band 7 Specification: MS + Battery + Adapter Specification N: LTE band 8 Specification: MS + Battery + Adapter Specification O: LTE band 20 Specification: MS + Battery + Adapter |
| MODE 2 IDLE MODE | Specification: MS + Battery + Adapter |
| MODE 3 BLUETOOTH MODE | Specification: MS + Battery+ Adapter |
| MODE 4 2.4GWIFI MODE | Specification: MS + Battery+ Adapter |
| MODE 5 GPS&GALILEO&BEIDOU& GLONASS& GLONASS MODE | Specification: MS + Battery+ Adapter |
| MODE 6 | FM Mode (By Adapter Charging) |
| MODE 7 | Camera (By Adapter Charging) |

| | |
|---|--------------------------------------|
| MODE 8 | Sound Recorder (By Adapter Charging) |
| MODE 9 | Audio Play (By Adapter Charging) |
| MODE 7 | Video Play (By Adapter Charging) |
| MODE 11 | IDLE Mode (By Adapter Charging) |
| MODE 12 | USB Mode (By PC data transferring) |
| Note: EMI and EMS contain the above test modes. All the modes had been tested but only the worst data recorded in the report. | |

Note:

1) ■ is operation mode.

2) Pre-scan above all test mode, found below test mode which it was worse case mode. Test results reported represents the worst case simultaneous transmission condition.

Pre-test conducted emission and radiated emission at both voltage AC 120V/60Hz and AC 230V/50Hz, recorded worst case.

Pre-test radiated emission with the EUT position at X-axis,Y-axis and Z-axis, recorded worst case.

| Test item | Test mode (Worse case mode) |
|--------------------|-----------------------------|
| Conducted emission | Mode 7 |
| Radiated emission | Mode 7 |
| EMS | All Mode |

4.3 Description of Test Setup

EUT was tested in normal configuration (Please See following Block diagrams)

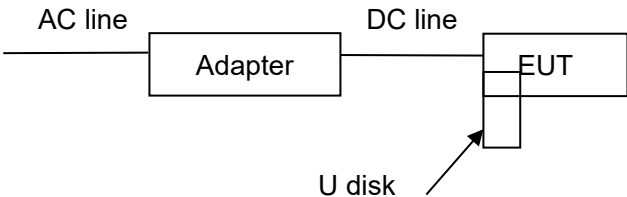
| |
|--|
| <p>1. Block diagram of EUT configuration-EMI</p> |
| <p>Mode1-4:</p>  |
| <p>2. Block diagram of EUT configuration-EMS</p> |
| <p>The same as above.</p> |

4.4 Test Peripheral List

| No. | Equipment | Manufacturer | EMC Compliance | Model No. | Serial No. | Power cord | Remark |
|-----|-----------|--------------|----------------|-----------|------------|------------|--------|
| 1 | -- | -- | -- | -- | N/A | N/A | N/A |

4.5 EUT Peripheral List

| No. | Equipment | Manufacturer | EMC Compliance | Model No. | Serial No. | signal cable | Remark |
|-----|-----------|--------------|----------------|-----------|------------|--------------|--------|
| 1 | Adapter | -- | CE | N/A | N/A | N/A | N/A |

5 Equipments List for All Test Items

| <input checked="" type="checkbox"/> Radiation Test Equipment | | | | | | |
|--|-------------------------------------|---------------|------------------|------------|------------|---------------|
| No | Test Equipment | Manufacturer | Model No | Serial No | Cal. Date | Cal. Due Date |
| 1 | EMI Measuring Receiver | R&S | ESR | 101160 | 2022.09.02 | 2023.09.01 |
| 2 | Low Noise Pre Amplifier | Tsj | MLA-10K01-B01-27 | 1205323 | 2022.09.02 | 2023.09.01 |
| 3 | TRILOG Super Broadband test Antenna | SCHWARZBECK | VULB9160 | 9160-3207 | 2021.08.29 | 2024.08.28 |
| 4 | 50Ω Coaxial Switch | Anritsu | MP59B | 6200264416 | 2022.09.02 | 2023.09.01 |
| 5 | Spectrum Analyzer | R&S | FSV40 | 101470 | 2022.09.02 | 2023.09.01 |
| 6 | Low Noise Pre Amplifier | Tsj | MLA-0120-A02-34 | 2648A04738 | 2022.09.02 | 2023.09.01 |
| 7 | Broadband Horn Antenna | Schwarzbeck | BBHA 9120D | 452 | 2021.08.29 | 2024.08.28 |
| 8 | Filter | MICRO-TRONICS | BRM50702-02 | 16 | 2022.09.02 | 2023.09.01 |
| 9 | Filter | MICRO-TRONICS | BRC50703-02 | 17 | 2022.09.02 | 2023.09.01 |
| 10 | Filter | MICRO-TRONICS | BRC50705-02 | 18 | 2022.09.02 | 2023.09.01 |

| <input checked="" type="checkbox"/> Conduction Test equipment | | | | | | |
|---|--------------------|--------------|----------|------------------------|------------|---------------|
| No | Test Equipment | Manufacturer | Model No | Serial No | Cal. Date | Cal. Due Date |
| 1 | EMI Test Receiver | R&S | ESCI | 100124 | 2022.09.02 | 2023.09.01 |
| 2 | LISN | Kyoritsu | KNW-242 | 8-837-4 | 2022.09.02 | 2023.09.01 |
| 3 | LISN | R&S | ESH3-Z2 | 0357.8810.54-101161-S2 | 2022.09.02 | 2023.09.01 |
| 4 | 50Ω Coaxial Switch | Anritsu | MP59B | 6200264417 | 2022.09.02 | 2023.09.01 |

| <input checked="" type="checkbox"/> H/F Test Equipment | | | | | | |
|--|--------------------------|--------------|-------------------|-----------|------------|---------------|
| No | Test Equipment | Manufacturer | Model No | Serial No | Cal. Date | Cal. Due Date |
| 1 | Signal Conditioning Unit | Schaffner | CCN1000-1 | 72472 | 2022.09.02 | 2023.09.01 |
| 2 | 5KV AC Power Source | Schaffner | NSG1007-5-208-413 | 57227 | 2022.09.02 | 2023.09.01 |

| <input checked="" type="checkbox"/> ESD Test Equipment | | | | | | |
|--|----------------|--------------|----------|-----------|------------|---------------|
| No | Test Equipment | Manufacturer | Model No | Serial No | Cal. Date | Cal. Due Date |
| 1 | ESD Simulator | Schaffner | NSG435 | 5866 | 2022.09.02 | 2023.09.01 |

| <input checked="" type="checkbox"/> R/S Test Equipment | | | | | | |
|--|------------------------------|--------------|------------------|------------|------------|---------------|
| No | Test Equipment | Manufacturer | Model No | Serial No | Cal. Date | Cal. Due Date |
| 1 | MXG analog signal generator | Agilent | N5181A | MY46240859 | 2022.09.02 | 2023.09.01 |
| 2 | Power Amplifier | Schaffner | CBA9433 | T43574 | 2022.09.02 | 2023.09.01 |
| 3 | Power Amplifier | Schaffner | CBA9409 | T43605 | 2022.09.02 | 2023.09.01 |
| 4 | Power Amplifier | Micotop | MPA-3000-6000-50 | MPA03724 | 2022.09.02 | 2023.09.01 |
| 5 | Logarithmic-periodic Antenna | Schwarzbeck | VULP9118E | 820 | 2022.09.02 | 2023.09.01 |
| 6 | Broadband Horn Antenna | Schwarzbeck | BBHA 9120LF | 255 | 2022.09.02 | 2023.09.01 |
| 7 | Power meter | Agilent | E4419B | MY45102079 | 2022.09.02 | 2023.09.01 |
| 8 | Power sensor | Agilent | 8481A | MY41097696 | 2022.09.02 | 2023.09.01 |
| 9 | Power sensor | Agilent | 8481A | MY41097697 | 2022.09.02 | 2023.09.01 |
| 10 | RF Relay matrix | tsj | RFM-S621 | 04261 | 2022.09.02 | 2023.09.01 |

| <input checked="" type="checkbox"/> EFT/B Test equipment | | | | | | |
|--|---------------------------|--------------|-------------|-----------|------------|---------------|
| No | Test Equipment | Manufacturer | Model No | Serial No | Cal. Date | Cal. Due Date |
| 1 | INS6501 Step-transformer | Schaffner | INA 6501 | 136 | 2022.09.02 | 2023.09.01 |
| 2 | MODULA GENERATOR | Schaffner | MODULA 6150 | 34475 | 2022.09.02 | 2023.09.01 |
| 3 | Capacitive Coupling Clamp | Schaffner | CDN8014 | 22519 | 2022.09.02 | 2023.09.01 |

| <input checked="" type="checkbox"/> Surge Test Equipment | | | | | | |
|--|--------------------------|--------------|-------------|-----------|------------|---------------|
| No | Test Equipment | Manufacturer | Model No | Serial No | Cal. Date | Cal. Due Date |
| 1 | INS6501 step-transformer | Schaffner | INA 6501 | 136 | 2022.09.02 | 2023.09.01 |
| 2 | MODULA GENERATOR | Schaffner | MODULA 6150 | 34475 | 2022.09.02 | 2023.09.01 |

| <input checked="" type="checkbox"/> C/S Test Equipment | | | | | | |
|--|------------------------|----------------------|--------------|-----------|------------|---------------|
| No | Test Equipment | Manufacturer | Model No | Serial No | Cal. Date | Cal. Due Date |
| 1 | SML01 Signal Generator | R&S | SML01 | 104531 | 2022.09.02 | 2023.09.01 |
| 2 | Power Amplifier | Schaffner | CBA9437 | T43660 | 2022.09.02 | 2023.09.01 |
| 3 | Attenuator | Aeroflex / Weinschel | 40-6-33 | PA130 | 2022.09.02 | 2023.09.01 |
| 4 | Power Line CDN | tsj | TSCDN-M1-16A | 07010 | 2022.09.02 | 2023.09.01 |
| 5 | Power Line CDN | tsj | TSCDN-M2-16A | 07024 | 2022.09.02 | 2023.09.01 |
| 6 | Power Line CDN | tsj | TSCDN-M3-16A | 07032 | 2022.09.02 | 2023.09.01 |

| <input checked="" type="checkbox"/> PFMF Test Equipment | | | | | | |
|---|-----------------------------|--------------|----------|-----------|------------|---------------|
| No | Test Equipment | Manufacturer | Model No | Serial No | Cal. Date | Cal. Due Date |
| 1 | Magnetic field generator | Schaffner | MFO6501 | 34299 | 2022.09.02 | 2023.09.01 |
| 2 | Magnetic Field Loop Antenna | Schaffner | INA 702 | 148 | 2022.09.02 | 2023.09.01 |

| <input checked="" type="checkbox"/> Dips Test Equipment | | | | | | |
|---|--------------------------|--------------|-------------|-----------|------------|---------------|
| No | Test Equipment | Manufacturer | Model No | Serial No | Cal. Date | Cal. Due Date |
| 1 | INS6501 Step-transformer | Schaffner | INA 6501 | 136 | 2022.09.02 | 2023.09.01 |
| 2 | MODULA GENERATOR | Schaffner | MODULA 6150 | 34475 | 2022.09.02 | 2023.09.01 |

| <input checked="" type="checkbox"/> Others Test Equipment | | | | | | |
|---|-------------------------------|--------------|----------|--------------|------------|---------------|
| No | Test Equipment | Manufacturer | Model No | Serial No | Cal. Date | Cal. Due Date |
| 1 | Wideband communication tester | R&S | CMW500 | 1201.0002K50 | 2022.09.02 | 2023.09.01 |

Note:

1. is not applicable in this Test Report. is applicable in this Test Report.

6 Emission Test Results

6.1 Conducted Emission(AC Mains) Measurement

| Frequency (MHz) | ☐ Class A (dBμV) | | ☒ Class B (dBμV) | |
|-----------------|-------------------|----------------|-------------------|----------------|
| | Q.P. (Quasi-Peak) | A.V. (Average) | Q.P. (Quasi-Peak) | A.V. (Average) |
| 0.15 ~ 0.50 | 79 | 66 | 66 to 56 | 56 to 46 |
| 0.50 ~ 5.0 | 73 | 60 | 56 | 46 |
| 5.0 ~ 30 | 73 | 60 | 60 | 50 |

Detector: Peak for pre-scan (9kHz Resolution Bandwidth)
 Quasi-Peak & Average if maximized peak within 6dB of Average Limit

6.1.1 E.U.T. Operation

| | | | | | | |
|--------------|-----------|-----------|--------|--------------------------|--------|-----|
| Temperature: | 23°C | Humidity: | 55% RH | Atmospheric Pressure: | 101 | Kpa |
| Test Mode: | All Modes | | | The Worst Mode reported: | Mode 7 | |

6.1.2 Test Specification

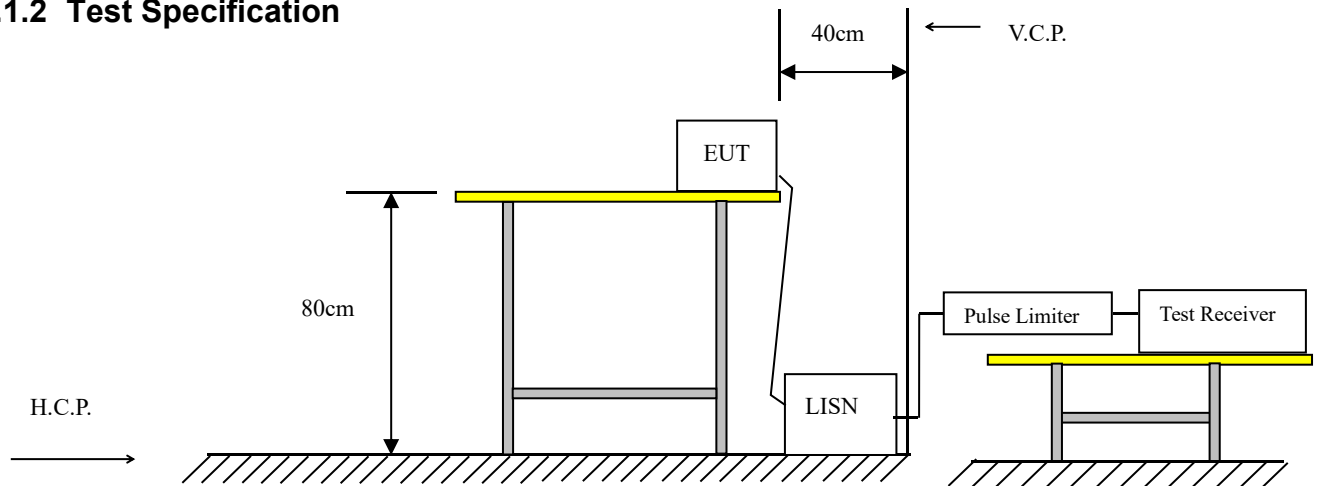

EUT was placed upon a wooden test table 0.8m above the horizontal metal reference plane and 0.4m from the vertical ground plane, and it was connected to an AMN. The closest distance between the boundary of the EUT and the surface of the AMN is 0.8m. All peripherals were connected to another AMN, and placed at a distance of 10cm from each other. A spectrum and receiver was connected to the RF output port of the AMN. Both average and quasi-peak value were detected.

6.1.3 Measurement Data

An initial pre-scan was performed on the live and neutral lines.

Quasi-peak or average measurements were performed at the frequency which maximum peak emissions were detected.

Please refer to the attached quasi-peak & average measurement data.

| | | | |
|---------------|--------------|--------------|--|
| Model name: | Active 8 | Test Date : | 2023.06.09 |
| Test Mode: | Mode 7 | Phase : | Line |
| Test Voltage: | AC 230V/50Hz | Test Result: | <input checked="" type="checkbox"/> Pass <input type="checkbox"/> Fail |

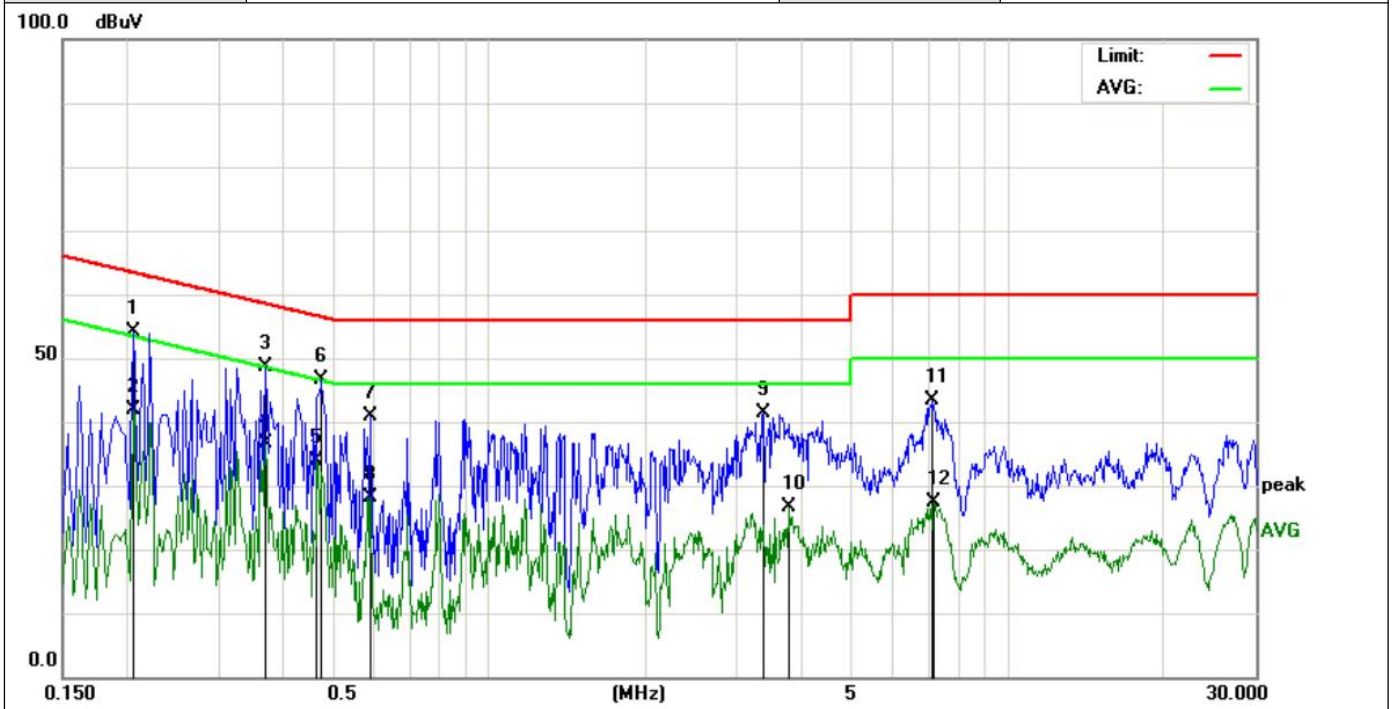

Remark: Correct Factor = LISN factor + Cable Loss + Pulse limiter factor.

Measurement Result=Reading Level +Correct Factor;

Over Limit= Measurement Result- Limit;

| No. | Mk. | Freq. MHz | Reading Level dBuV | Correct Factor dB | Measure- ment dBuV | Limit dBuV | Over dB | Detector |
|-----|-----|--------------|--------------------------|-------------------------|--------------------------|---------------|------------|----------|
| 1 | * | 0.2060 | 54.12 | 0.00 | 54.12 | 63.36 | -9.24 | QP |
| 2 | | 0.2060 | 41.92 | 0.00 | 41.92 | 53.36 | -11.44 | AVG |
| 3 | | 0.3700 | 48.70 | 0.00 | 48.70 | 58.50 | -9.80 | QP |
| 4 | | 0.3700 | 36.65 | 0.00 | 36.65 | 48.50 | -11.85 | AVG |
| 5 | | 0.4660 | 33.77 | 0.00 | 33.77 | 46.58 | -12.81 | AVG |
| 6 | | 0.4740 | 46.56 | 0.00 | 46.56 | 56.44 | -9.88 | QP |
| 7 | | 0.5899 | 40.97 | 0.00 | 40.97 | 56.00 | -15.03 | QP |
| 8 | | 0.5899 | 28.19 | 0.00 | 28.19 | 46.00 | -17.81 | AVG |
| 9 | | 3.3700 | 41.45 | 0.00 | 41.45 | 56.00 | -14.55 | QP |
| 10 | | 3.7780 | 26.60 | 0.00 | 26.60 | 46.00 | -19.40 | AVG |
| 11 | | 7.1620 | 43.38 | 0.00 | 43.38 | 60.00 | -16.62 | QP |
| 12 | | 7.1820 | 27.49 | 0.00 | 27.49 | 50.00 | -22.51 | AVG |

| | | | |
|---------------|--------------|--------------|--|
| Model name: | Active 8 | Test Date : | 2023.06.09 |
| Test Mode: | 10 | Phase : | Neutral |
| Test Voltage: | AC 230V/50Hz | Test Result: | <input checked="" type="checkbox"/> Pass <input type="checkbox"/> Fail |

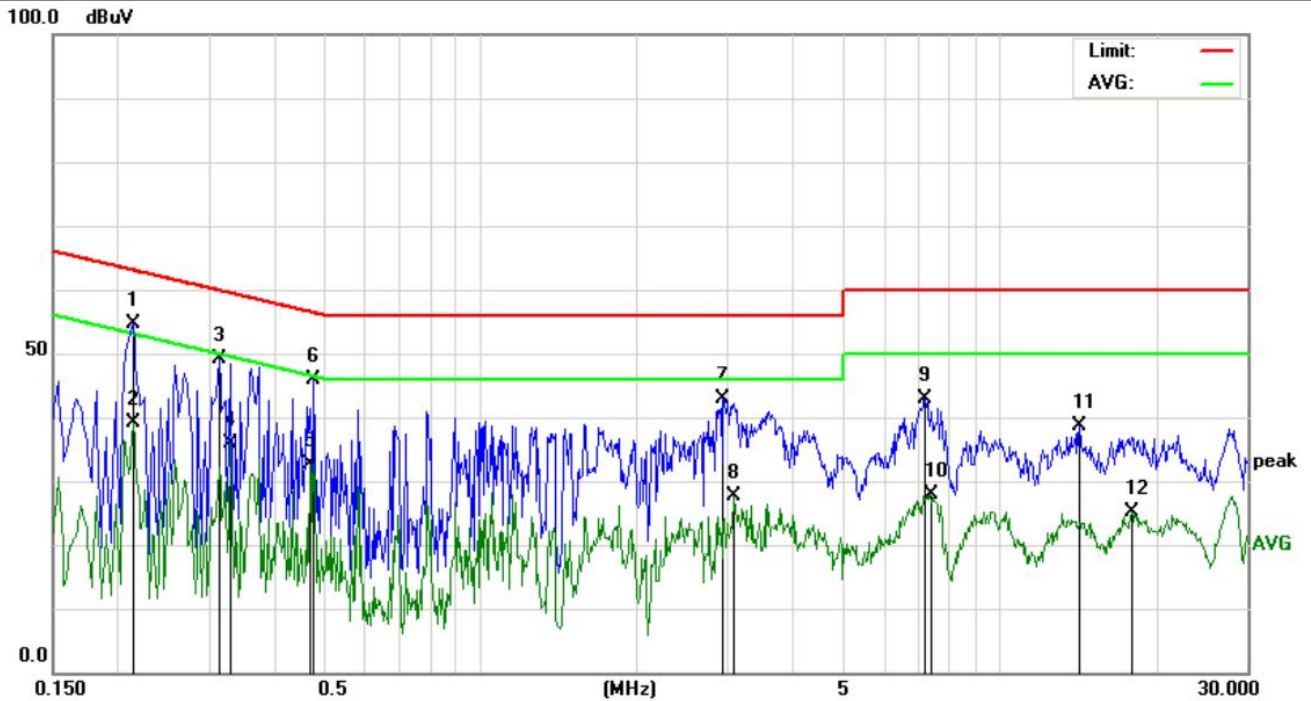

Remark: Correct Factor = LISN factor + Cable Loss + Pulse limiter factor.

Measurement Result=Reading Level +Correct Factor;

Over Limit= Measurement Result- Limit;

| No. | Mk. | Freq. MHz | Reading Level dBuV | Correct Factor dB | Measure- ment dBuV | Limit dBuV | Over dB | Detector |
|-----|-----|--------------|--------------------------|-------------------------|--------------------------|---------------|------------|----------|
| 1 | * | 0.2140 | 54.64 | 0.00 | 54.64 | 63.04 | -8.40 | QP |
| 2 | | 0.2140 | 39.16 | 0.00 | 39.16 | 53.04 | -13.88 | AVG |
| 3 | | 0.3140 | 49.24 | 0.00 | 49.24 | 59.86 | -10.62 | QP |
| 4 | | 0.3300 | 35.88 | 0.00 | 35.88 | 49.45 | -13.57 | AVG |
| 5 | | 0.4700 | 32.68 | 0.00 | 32.68 | 46.51 | -13.83 | AVG |
| 6 | | 0.4780 | 45.88 | 0.00 | 45.88 | 56.37 | -10.49 | QP |
| 7 | | 2.9380 | 42.99 | 0.00 | 42.99 | 56.00 | -13.01 | QP |
| 8 | | 3.0820 | 27.65 | 0.00 | 27.65 | 46.00 | -18.35 | AVG |
| 9 | | 7.1940 | 42.95 | 0.00 | 42.95 | 60.00 | -17.05 | QP |
| 10 | | 7.3540 | 27.84 | 0.00 | 27.84 | 50.00 | -22.16 | AVG |
| 11 | | 14.2860 | 38.55 | 0.00 | 38.55 | 60.00 | -21.45 | QP |
| 12 | | 17.9540 | 25.25 | 0.00 | 25.25 | 50.00 | -24.75 | AVG |

6.2 Conducted Emission(Wired network ports) Measurement

| Frequency (MHz) | <input type="checkbox"/> Class A (dBμV) | | <input checked="" type="checkbox"/> Class B (dBμV) | |
|-----------------|---|----------------|--|----------------|
| | Q.P. (Quasi-Peak) | A.V. (Average) | Q.P. (Quasi-Peak) | A.V. (Average) |
| 0.15 ~ 0.50 | 97 to 87 | 84 to 74 | 84 to 74 | 74 to 64 |
| 0.50 ~ 30 | 87 | 74 | 74 | 64 |

| | |
|-----------|---|
| Detector: | Peak for pre-scan (9kHz Resolution Bandwidth) Quasi-Peak & Average if maximized peak within 6dB of Average Limit |
|-----------|---|

6.2.1 E.U.T. Operation

| | | | | | | |
|--------------|-----------|-----------|--------------------------|-----------------------|-----|-----|
| Temperature: | 23°C | Humidity: | 55% RH | Atmospheric Pressure: | 101 | Kpa |
| Test Mode: | All Modes | | The Worst Mode reported: | Mode 7 | | |

6.2.2 Test Specification

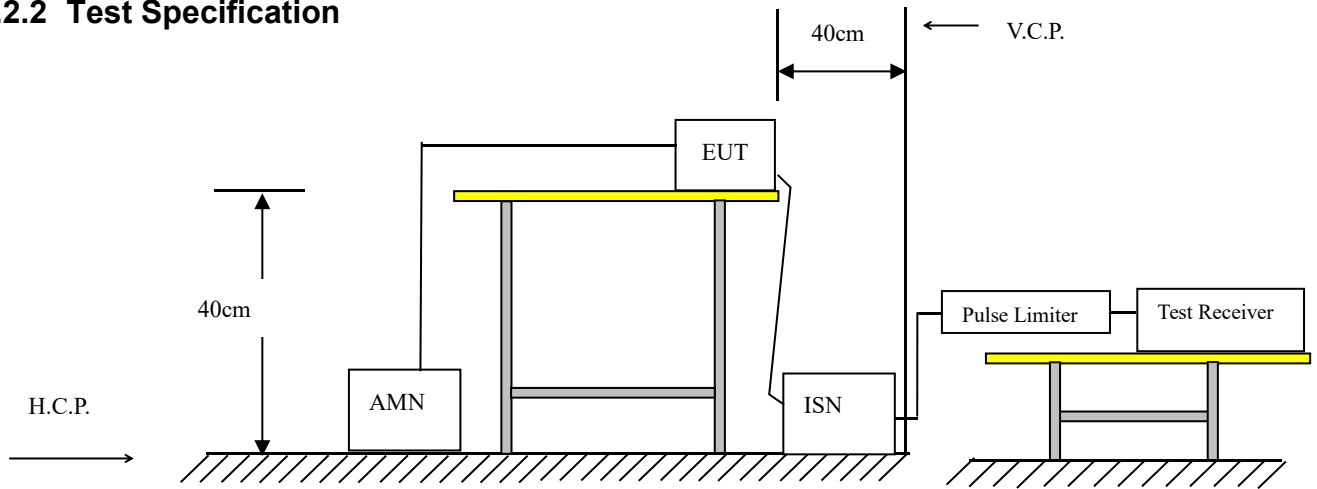

EUT was placed upon a wooden test table 0.4m above the horizontal metal reference plane and 0.4m from the vertical ground plane, and it was connected to an AMN. The closest distance between the boundary of the EUT and the surface of the AMN is 0.8m. All peripherals were connected to another AMN, and placed at a distance of 10cm from each other. A ISN is used for connect the Wired network ports of the EUT and the Test Peripheral, A spectrum and receiver was connected to the RF output port of the ISN. Both average and quasi-peak value were detected.

6.2.3 Measurement Data

Not Applicable

6.3 Radiated Emission Measurement

Limits of Radiated Emission Measurement (Below 1GHz)

| Frequency (MHz) | <input type="checkbox"/> Class A (10m) | <input checked="" type="checkbox"/> Class B (3m) |
|-----------------|--|--|
| | Quasi-Peak dB(μV/m) | |
| 30 ~ 230 | 40.0 | 40.0 |
| 230 ~ 1000 | 47.0 | 47.0 |

Limits of Radiated Emission Measurement (Above 1GHz)

| Frequency (MHz) | <input type="checkbox"/> Class A (3m) | | <input checked="" type="checkbox"/> Class B (3m) | |
|-----------------|---------------------------------------|------------------|--|------------------|
| | Quasi-Peak dB(μV/m) | Average dB(μV/m) | Quasi-Peak dB(μV/m) | Average dB(μV/m) |
| 1000~6000 | 76.0 | 56.0 | 74.0 | 54.0 |

6.3.1 E.U.T. Operation

| | | | | | | |
|--------------|-----------|-----------|--------|--------------------------|--------|-----|
| Temperature: | 24°C | Humidity: | 52% RH | Atmospheric Pressure: | 101 | Kpa |
| Test Mode: | All Modes | | | The Worst Mode reported: | Mode 4 | |

6.3.2 Test Specification

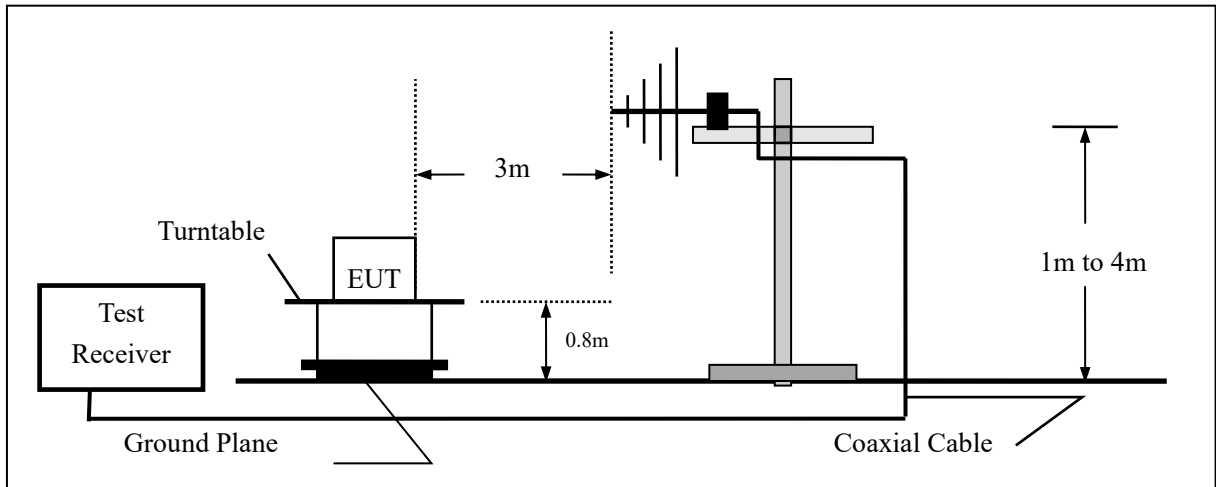

Radiated emission test set-up, frequency below 1000MHz:

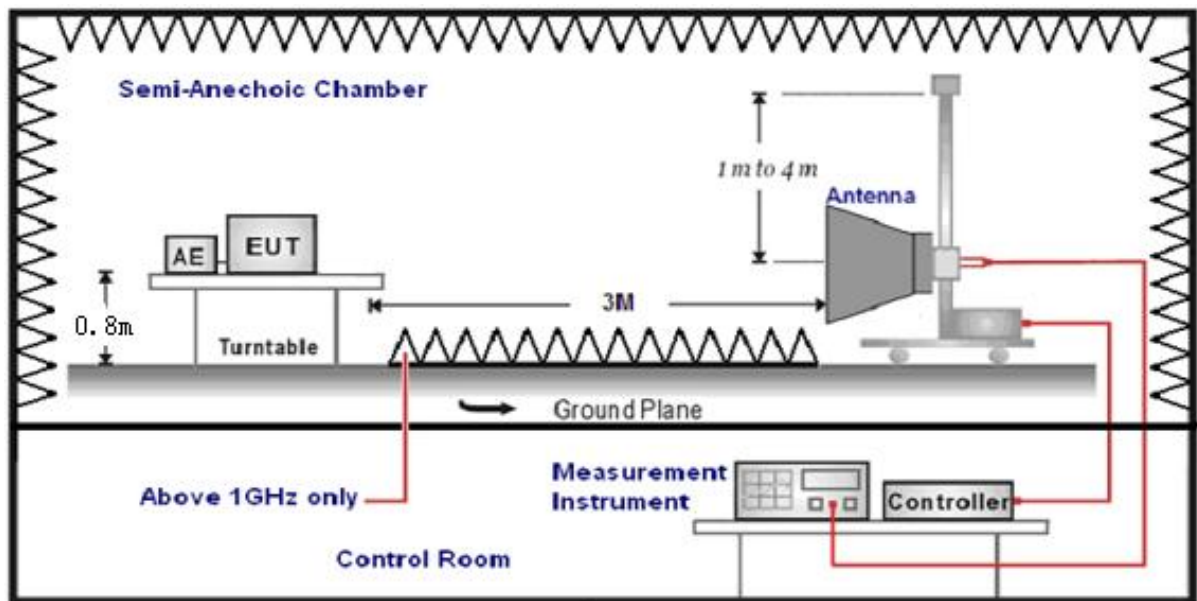

Radiated emission test set-up, frequency above 1000MHz

EUT was placed upon a wooden test table which was placed on the turn table 0.8m above the horizontal metal ground plane, and operating in the mode as mentioned above. A receiving antenna was placed 3m away from the EUT. During testing, turn around the turn table and move the antenna from 1m to 4m to find the maximum field-strength reading. All peripherals were placed at a distance of 10cm between each other. Both horizontal and vertical antenna polarities were tested.

6.3.3 Measurement Data

| | | | |
|---------------|--------------|--------------|--|
| Model name: | Active 8 | Test Date : | 2023.06.09 |
| Test Mode: | Mode 8 | Phase : | Vertical |
| Test Voltage: | AC 230V/50Hz | Test Result: | <input checked="" type="checkbox"/> Pass <input type="checkbox"/> Fail |

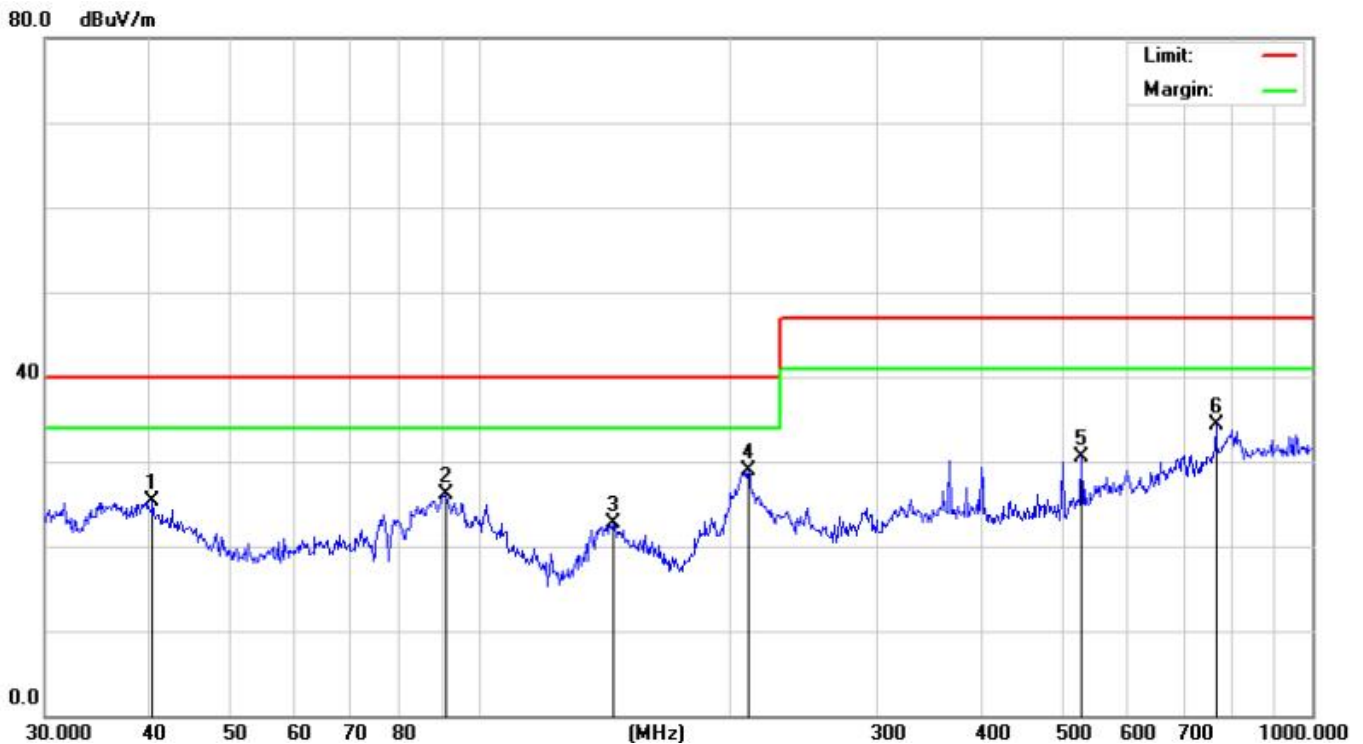

Remark: Factor = Antenna Factor + Cable Loss – Pre-amplifier.

Measurement Result=Reading Level +Correct Factor;

Over Limit= Measurement Result- Limit;

| No. | Mk. | Freq. MHz | Reading Level dBuV | Correct Factor dB | Measure- ment dBuV/m | Limit dBuV/m | Over dB | Detector |
|-----|-----|--------------|--------------------------|-------------------------|----------------------------|-----------------|------------|----------|
| 1 | | 40.4172 | 23.74 | 1.62 | 25.36 | 40.00 | -14.64 | QP |
| 2 | | 90.8554 | 30.50 | -4.45 | 26.05 | 40.00 | -13.95 | QP |
| 3 | | 144.3348 | 24.04 | -1.29 | 22.75 | 40.00 | -17.25 | QP |
| 4 | * | 210.0482 | 26.78 | 2.18 | 28.96 | 40.00 | -11.04 | QP |
| 5 | | 528.2458 | 24.70 | 5.85 | 30.55 | 47.00 | -16.45 | QP |
| 6 | | 766.0571 | 23.20 | 11.11 | 34.31 | 47.00 | -12.69 | QP |

Note: While performing the testing, the notch filter is used for avoiding test instrument overload.

| | | | |
|---------------|--------------|----------------|--|
| Model name: | Active 8 | Test Date : | 2023.06.17 |
| Test Mode: | Mode 7 | Polarization : | Horizontal |
| Test Voltage: | AC 230V/50Hz | Test Result: | <input checked="" type="checkbox"/> Pass <input type="checkbox"/> Fail |



Remark: Factor = Antenna Factor + Cable Loss – Pre-amplifier.
 Measurement Result=Reading Level +Correct Factor;
 Over Limit= Measurement Result- Limit;

| No. | Mk. | Freq. MHz | Reading Level dBuV | Correct Factor dB | Measure- ment dBuV/m | Limit dBuV/m | Over dB | Detector |
|-----|-----|--------------|--------------------------|-------------------------|----------------------------|-----------------|------------|----------|
| 1 | | 45.8553 | 20.65 | 3.46 | 24.11 | 40.00 | -15.89 | QP |
| 2 | | 107.8877 | 26.33 | -1.21 | 25.12 | 40.00 | -14.88 | QP |
| 3 | * | 206.3976 | 31.03 | -1.25 | 29.78 | 40.00 | -10.22 | QP |
| 4 | | 312.1794 | 26.43 | 1.78 | 28.21 | 47.00 | -18.79 | QP |
| 5 | | 528.2458 | 24.98 | 9.36 | 34.34 | 47.00 | -12.66 | QP |
| 6 | | 766.0571 | 21.71 | 12.39 | 34.10 | 47.00 | -12.90 | QP |

Note: While performing the testing, the notch filter is used for avoiding test instrument overload.

| | | | |
|---------------|--------------|--------------|--|
| Model name: | Active 8 | Test Date : | 2022-01-09 |
| Test Mode: | Mode 8 | Phase : | Vertical |
| Test Voltage: | AC 230V/50Hz | Test Result: | <input checked="" type="checkbox"/> Pass <input type="checkbox"/> Fail |

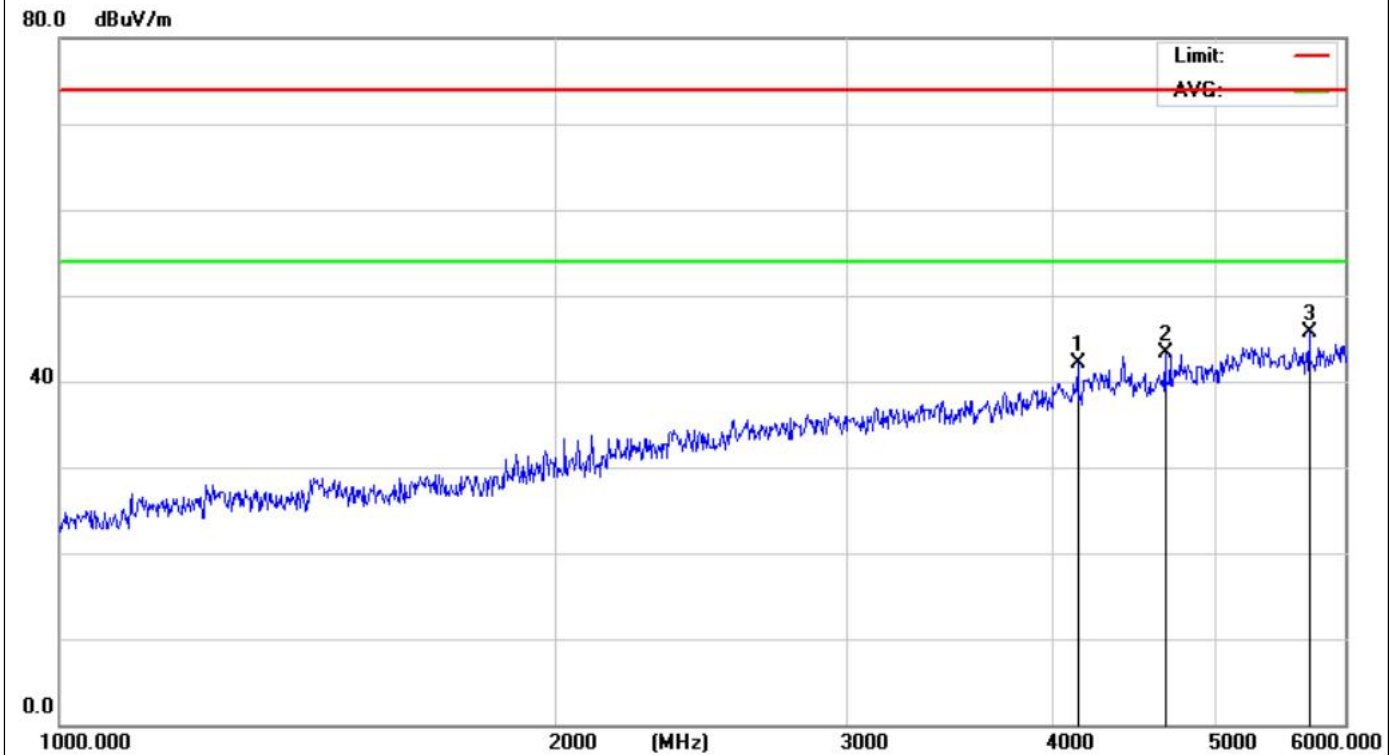

Remark: Factor = Antenna Factor + Cable Loss – Pre-amplifier.
 Measurement Result=Reading Level +Correct Factor;
 Over Limit= Measurement Result- Limit;

| No. | Mk. | Freq. | Reading Level | Correct Factor | Measurement | Limit | Over | |
|-----|-----|----------|---------------|----------------|-------------|--------|--------|----------|
| | | MHz | dBuV | dB | dBuV/m | dBuV/m | dB | Detector |
| 1 | | 4133.289 | 36.85 | 5.25 | 42.10 | 74.00 | -31.90 | peak |
| 2 | | 4668.852 | 37.70 | 5.70 | 43.40 | 74.00 | -30.60 | peak |
| 3 | * | 5706.411 | 39.45 | 6.35 | 45.80 | 74.00 | -28.20 | peak |

Note: While performing the testing, the notch filter is used for avoiding test instrument overload.

| | | | |
|---------------|--------------|----------------|--|
| Model name: | Active 8 | Test Date : | 2023.06.17 |
| Test Mode: | Mode 7 | Polarization : | Horizontal |
| Test Voltage: | AC 230V/50Hz | Test Result: | <input checked="" type="checkbox"/> Pass <input type="checkbox"/> Fail |

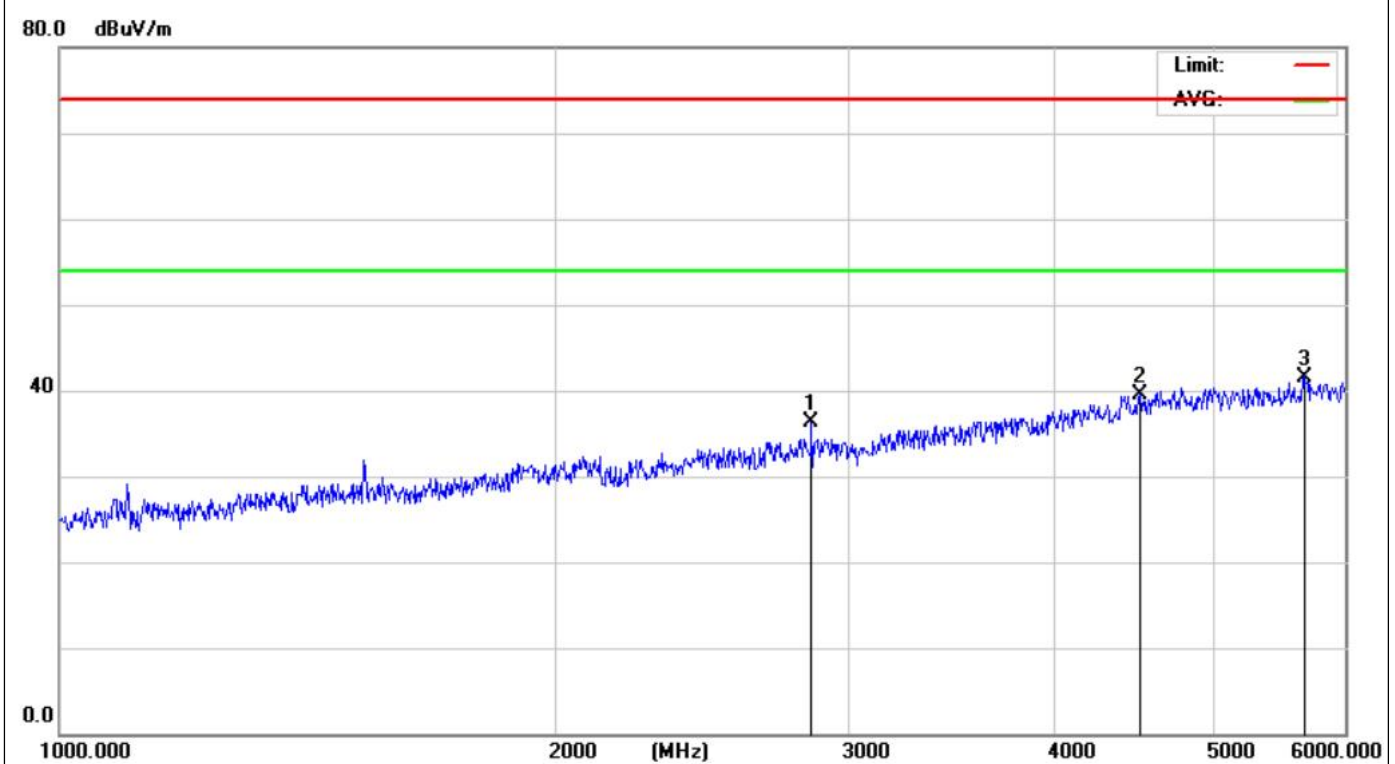

Remark: Factor = Antenna Factor + Cable Loss – Pre-amplifier.
 Measurement Result=Reading Level +Correct Factor;
 Over Limit= Measurement Result- Limit;

| No. | Mk. | Freq. MHz | Reading Level dBuV | Correct Factor dB | Measure- ment dBuV/m | Limit dBuV/m | Over dB | Detector |
|-----|-----|--------------|--------------------------|-------------------------|----------------------------|-----------------|------------|----------|
| 1 | | 2852.453 | 31.99 | 4.31 | 36.30 | 74.00 | -37.70 | peak |
| 2 | | 4512.583 | 34.03 | 5.57 | 39.60 | 74.00 | -34.40 | peak |
| 3 | * | 5665.659 | 35.26 | 6.34 | 41.60 | 74.00 | -32.40 | peak |

Note: While performing the testing, the notch filter is used for avoiding test instrument overload.

6.4 Harmonics

| | |
|------------------|---------------|
| Frequency Range: | 100Hz to 2kHz |
|------------------|---------------|

| | |
|-------------------|--------------|
| Test Requirement: | EN 61000-3-2 |
|-------------------|--------------|

6.4.1 E.U.T. Operation

| | | | | | | |
|--------------|------|-----------|--------|-----------------------|-----|-----|
| Temperature: | 25°C | Humidity: | 50% RH | Atmospheric Pressure: | 101 | Kpa |
|--------------|------|-----------|--------|-----------------------|-----|-----|

| | | | |
|------------|-----------|--------------------------|--------|
| Test Mode: | All Modes | The Worst Mode reported: | Mode 4 |
|------------|-----------|--------------------------|--------|

6.4.2 Test specification

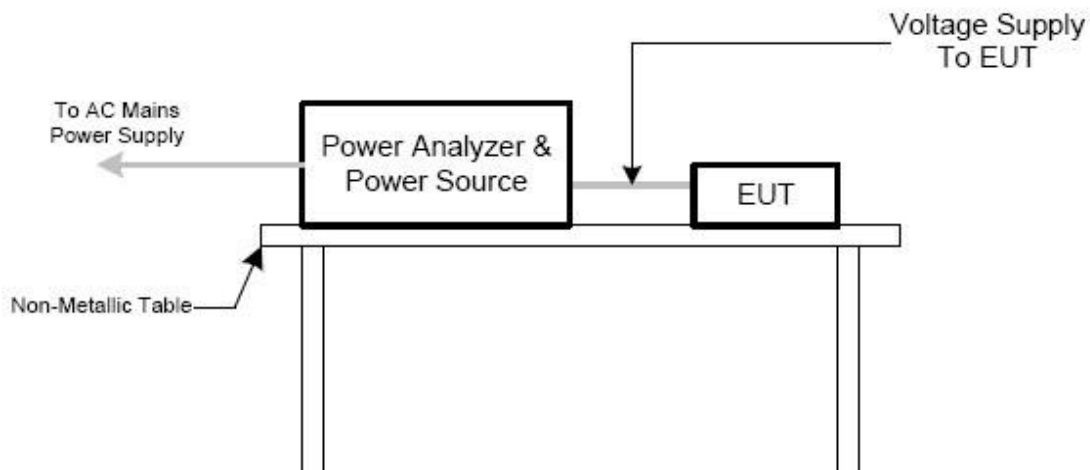

EUT operated in the mode as mentioned above, and connected to Harmonic/Flicker measuring equipment which was connected to an AC power source. Measurement was performed after EUT operating in static state for 10 seconds. Each order harmonics found to meet the relevant limits.

6.4.3 Measurement Data

| | |
|-------------------|------------------------|
| Test Requirement: | EN IEC 61000-3-2 |
| Frequency range: | 100Hz to 2kHz |
| Measurement Time: | 3 min |
| Test result: | N/A (See Remark Below) |

Remark:

Since the EUT (rated power is less than 75W) was belong to exception of clause 7 and Annex C, according to EN 61000-3-2 figure 1, it was deemed to conform to the requirements of this standard without further testing.

“The procedure for applying the limits and assessing the results is shown in Figure 1.

For the following categories of equipment limits are not specified in this edition of the standard.

Note 1: Equipment with a rated power of 75W or less, other than lighting equipment.

NOTE 2 This value may be reduced from 75 W to 50 W in the future, subject to approval by National Committees at that time.

- professional equipment with a total rated power greater than 1 kW;
- symmetrically controlled heating elements with a rated power less than or equal to 200 W;
- independent dimmers for incandescent lamps with a rated power less than or equal to 1 kW.

NOTE 3 See also C.5.3.”

And

No limit applies for all lighting equipments with active input power ≤ 25 W except

Discharge lighting equipment (refer to 7.3 b)

For further details, please refer to Clause 7 & Annex C of EN 61000-3-2 for reference.

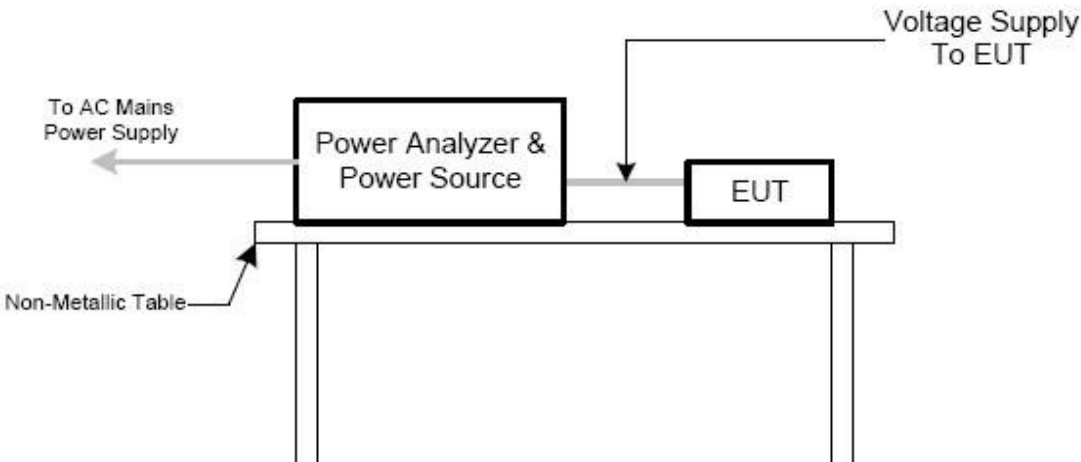
| | | | | | | |
|--|-----------|--------------|--------|-----------------------|--------|-----|
| 6.5 Voltage changes, voltage fluctuations and flicker | | | | | | |
| Test Requirement: | | EN 61000-3-3 | | | | |
| 6.5.1 E.U.T. Operation | | | | | | |
| Temperature: | 25°C | Humidity: | 50% RH | Atmospheric Pressure: | 101 | Kpa |
| Test Mode: | All Modes | | | The Worst Mode: | Mode 8 | |
| 6.5.2 Test specification | | | | | | |
|  <p>The diagram illustrates the test setup. A 'Power Analyzer & Power Source' is placed on a 'Non-Metallic Table'. An arrow labeled 'To AC Mains Power Supply' points from the power source to the left. Another arrow labeled 'Voltage Supply To EUT' points from the power source to a box labeled 'EUT' on the table.</p> | | | | | | |
| <p>EUT was operated in the mode as mentioned above, and connected to Harmonic/Flicker measuring equipment which was connected to an AC power source.</p> | | | | | | |

6.5.3 Measurement Data

| | | |
|---------------|--------------|---|
| M/N: | Active 8 | Test Result: <input checked="" type="checkbox"/> Pass <input type="checkbox"/> Fail |
| Test Voltage: | AC 230V/50Hz | Test date: 2022-06-12 |

Test category: All parameters (European limits) Test Margin: 100

Test Result: Pass Status: Test Completed

Pstj and limit line

European Limits

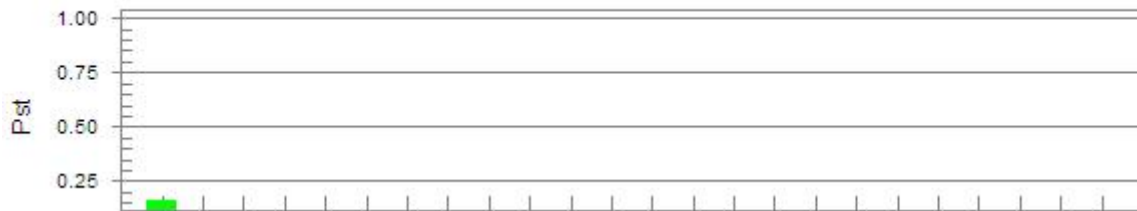

Plt and limit line

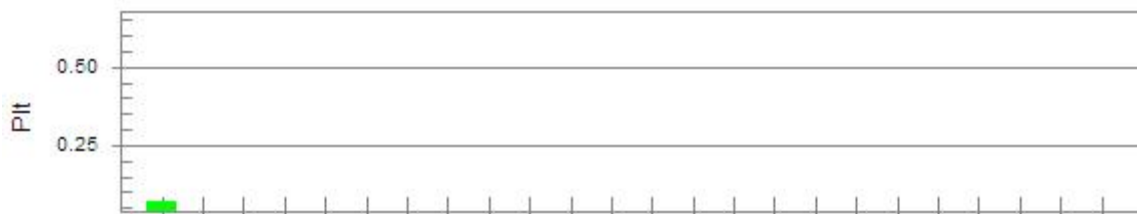

Parameter values recorded during the test:

Vrms at the end of test (Volt): 230.58

| | | | | |
|--------------------------------------|--------------|-------------------------|--------------|-------------|
| Highest dt (%): | 0.23 | Test limit (%): | 3.30 | Pass |
| Time(mS) > dt: | 0.0 | Test limit (mS): | 500.0 | Pass |
| Highest dc (%): | 0.00 | Test limit (%): | 3.30 | Pass |
| Highest dmax (%): | 0.11 | Test limit (%): | 4.00 | Pass |
| Highest Pst (10 min. period): | 0.067 | Test limit: | 1.000 | Pass |
| Highest Plt (2 hr. period): | 0.021 | Test limit: | 0.650 | Pass |

7 Immunity Test Results

7.1 Electrostatic discharge immunity test

| | |
|-----------------------------------|---------------------------------|
| Acceptable Performance Criterion: | B |
| Discharge Impedance: | 330 Ω / 150 pF |
| Discharge Voltage: | Air Discharge: ±4 kV, ±8 kV |
| | Contact Discharge: ±2 kV, ±4 kV |
| | VCP, HCP: ±2 kV, ±4 kV |
| Polarity: | Positive & Negative |
| Minimum discharge Interval: | 1 second |

7.1.1 E.U.T. Operation

| | | | | | | |
|--------------|-----------|-----------|--------|-----------------------|-----|-----|
| Temperature: | 25°C | Humidity: | 50% RH | Atmospheric Pressure: | 101 | Kpa |
| Test Mode: | All Modes | | | | | |

7.1.2 Test Specification

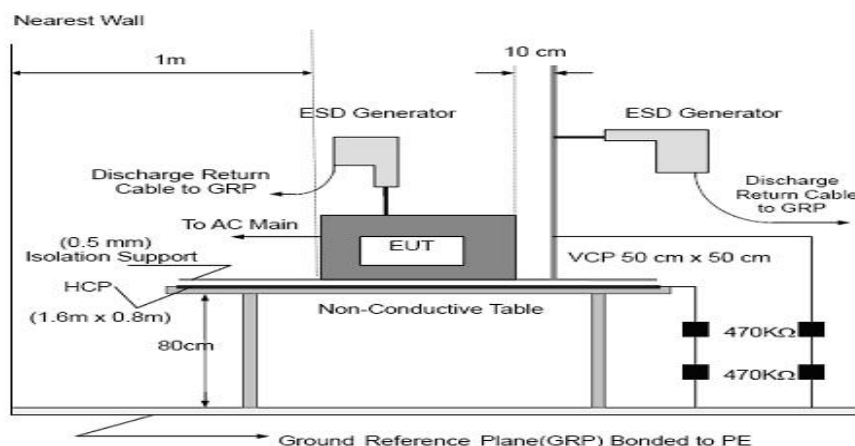

EUT was operated in the mode as mentioned above. Both contact and air discharge was executed. Contact discharge to the conductive surfaces and to coupling planes; air discharge at insulating surfaces. Each test point shall be subjected to 10 discharges at least (For each voltage and polarity).

7.1.3 Measurement Data

Test Record

| Electrostatic Discharge Test Results | | | | | | | | | | | | | | | | | | |
|---|---|---|---|---|----|---|----|---|---|---|---|---|---|---|---|---|-----------------------|--------|
| M/N: | Active 8 | | | | | | | | Test Result: <input checked="" type="checkbox"/> Pass <input type="checkbox"/> Fail | | | | | | | | | |
| Test Voltage: | AC 230V/50Hz | | | | | | | | Test date: 2023-06-09 | | | | | | | | | |
| Discharge times | Contact discharge: minimum <u>10</u> times (+/-respectively) at each point, Air discharge: minimum <u>10</u> times (+/- respectively) at each point. | | | | | | | | | | | | | | | | | |
| Discharge Mode | Air Discharge | | | | | | | | Contact Discharge | | | | | | | | Performance Criterion | Result |
| | 4 | | 8 | | 10 | | 15 | | 2 | | 4 | | 6 | | 8 | | | |
| Test Location | + | - | + | - | + | - | + | - | + | - | + | - | + | - | + | - | | |
| HCP | / | / | / | / | / | / | / | / | A | A | A | A | / | / | / | / | B | Pass |
| VCP | / | / | / | / | / | / | / | / | A | A | A | A | / | / | / | / | | Pass |
| A1 | A | A | A | A | / | / | / | / | / | / | / | / | / | / | / | / | | Pass |
| A2 | A | A | A | A | / | / | / | / | / | / | / | / | / | / | / | / | | Pass |
| A3 | A | A | A | A | / | / | / | / | / | / | / | / | / | / | / | / | | Pass |
| A4 | A | A | A | A | / | / | / | / | / | / | / | / | / | / | / | / | | Pass |
| A5 | A | A | A | A | / | / | / | / | / | / | / | / | / | / | / | / | | Pass |
| <p>Note 1): Horizontal Coupling Plane (HCP) and Vertical Coupling plane (VCP).</p> <p>Note 2): “Cx” means Contact Point ,x=1~N,“Ax” means Air Point, x=1~N.</p> <p>Note 3): “A” stand for, No degradation in performance of the EUT was observed. “B” stand for, Degradation in performance of the EUT occurred during the application of the disturbance, after the test, EUT can self-recovered and operate as intended.</p> | | | | | | | | | | | | | | | | | | |

7.2 RF Field Strength Immunity Test

| | |
|-----------------------------------|-----------------------|
| Acceptable Performance Criterion: | A |
| Test Level | 3 V/m |
| Test Distance | 3 m |
| Frequency Range | 80MHz~6000MHz |
| Polarity: | Horizontal & Vertical |

7.2.1 E.U.T. Operation

| | | | | | | |
|--------------|-----------|-----------|--------|-----------------------|-----|-----|
| Temperature: | 26°C | Humidity: | 54% RH | Atmospheric Pressure: | 101 | Kpa |
| Test Mode: | All Modes | | | | | |

7.2.2 TEST PROCEDURE

The EUT and support equipment, which are placed on a table that is 0.8 meter above ground and the testing was performed in a fully-anechoic chamber.

The testing distance from antenna to the EUT was 3 meters.

The other condition as following manner:

- a. The field strength level was 3V/m.
- b. The frequency range is swept from 80 MHz to 1000 MHz, & 1000MHz - 6000MHz with the signal 80%amplitude modulated with a 1kHz sine wave. The rate of sweep did not exceed 1.5×10^{-3} decade/s. Where the frequency range is swept incrementally, the step size was 1% of fundamental.
- c. Sweep Frequency 900 MHz, with the Duty Cycle:1/8 and Modulation: Pulse 217 Hz(if applicable)
- d. The dwell time at each frequency shall be not less than the time necessary for the EUT to be able to respond.
- e. The test was performed with the EUT exposed to both vertically and horizontally polarized fields on each of the four sides.
- f. For the actual test configuration, please refer to the related Item –EUT Test Photos.

7.2.3 Test Specification

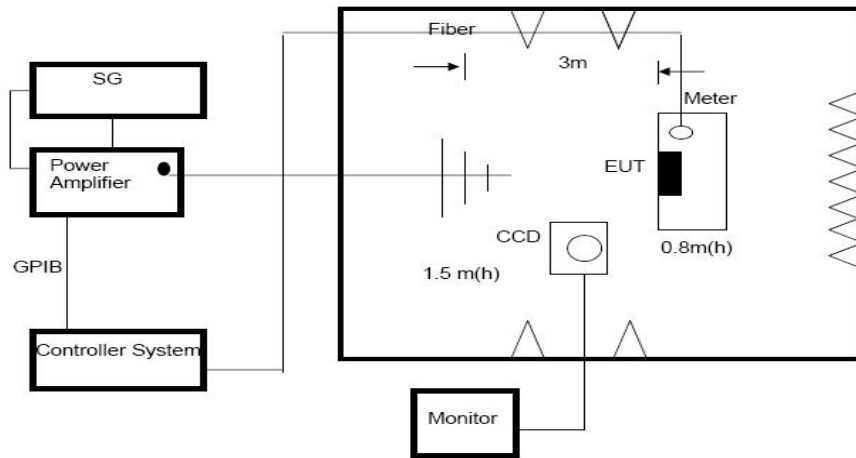

TABLE-TOP EQUIPMENT

The EUT installed in a representative system as described in section 7 of IEC/EN 61000-4-3 was placed on a non-conductive table 0.8 meters in height. The system under test was connected to the power and signal wire according to relevant installation instructions.

FLOOR-STANDING EQUIPMENT

The EUT installed in a representative system as described in section 7 of IEC/EN 61000-4-3 was placed on a non-conductive wood support 0.1 meters in height. The system under test was connected to the power and signal wire according to relevant installation instructions.

7.2.4 Measurement Data

| Radiated Frequency Field Strength Susceptibility Results | | |
|--|--------------|---|
| M/N: | Active 8 | Test Result: <input checked="" type="checkbox"/> Pass <input type="checkbox"/> Fail |
| Test Voltage: | AC 230V/50Hz | Test date: 2023-06-09~2023-01-10 |
| Test Port | Enclosure | |

| Frequency | Level | Modulation | Antenna Polarization | EUT Face | Observations (Performance Criterion) | Result |
|--------------|-------|--|----------------------|----------|--------------------------------------|--------|
| 80 MHz-6 GHz | 3 V/m | 1 kHz, 80 % Amp. Mod, 1 % increment, dwell time=3seconds | V | Front | A | Pass |
| | | | H | | A | Pass |
| | | | V | Rear | A | Pass |
| | | | H | | A | Pass |
| | | | V | Left | A | Pass |
| | | | H | | A | Pass |
| | | | V | Right | A | Pass |
| | | | H | | A | Pass |
| | | | V | Top | A | Pass |
| | | | H | | A | Pass |
| | | | V | Bottom | A | Pass |
| | | | H | | A | Pass |

Note: "A" stand for, during test, operate as intended no loss of function, no degradation of performance, no unintentional transmissions and after test, no degradation of performance, no loss of function, no loss of stored data or user programmable functions.

Special conditions for EMC immunity tests

| EUT operating Mode | PER during test(Worst) | PER Limit | Result |
|---------------------------------|------------------------|-----------|--------|
| BT | 4.1% | 10% | Pass |
| WIFI 2.4G | 4.2% | 10% | Pass |
| GSM/GPRS/EGPRS 900 MHz, Traffic | 5.02% | 10% | Pass |
| UMTS/HSPA 900 MHz, Traffic | 4.93% | 10% | Pass |
| LTE BAND 1 Traffic | 5.00% | 10% | Pass |
| LTE BAND 3 Traffic | 5.10% | 10% | Pass |
| LTE BAND 7 Traffic | 4.86% | 10% | Pass |
| LTE BAND 8 Traffic | 4.05% | 10% | Pass |
| LTE BAND 20 Traffic | 3.77% | 10% | Pass |

7.3 Electrical fast transient/burst immunity test

| | |
|-----------------------------------|--|
| Acceptable Performance Criterion: | B |
| Test Level: | 0.5, 1.0, kV on AC Line 0.5 kV on DC line or signal or wired network Line |
| Repetition Frequency: | 5 kHz and 100KHz |
| Burst Duration: | 300 ms |
| Test Duration: | 1 minutes for each level & polarity |

7.3.1 E.U.T. Operation

| | | | | | | |
|--------------|-----------|-----------|--------|-----------------------|-----|-----|
| Temperature: | 25°C | Humidity: | 50% RH | Atmospheric Pressure: | 101 | Kpa |
| Test Mode: | All Modes | | | | | |

7.3.2 Test specification

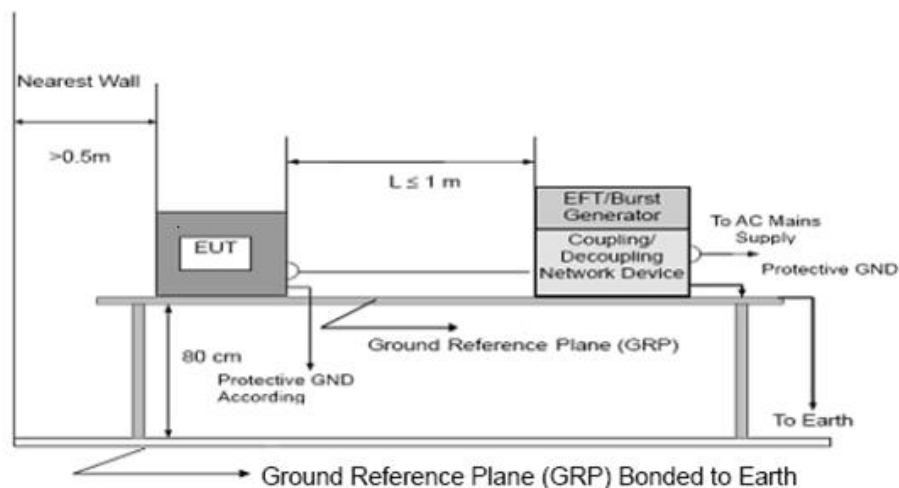

EUT was placed on a metal ground reference plane and was insulated from it by a wooden support which is 0.1m thick. The ground reference plane is connected to the protective earth. The test generator and the coupling/decoupling network were placed directly on, and bonded to the ground reference plane.

7.3.3 Measurement Data

Test Record

| Electrical Fast Transient/Burst Result | | | | | | | | | | | |
|--|--------|--|---|---|---|---|---|---|---|-----------------------|--------|
| M/N: | | Active 8 | | | | Test Result: <input checked="" type="checkbox"/> Pass <input type="checkbox"/> Fail | | | | | |
| Test Voltage: | | AC 230V/50Hz | | | | Test date: 2023-06-09 | | | | | |
| Test Signal | | Rise time: 5ns, Duration: 50ns, repetition rate : <input checked="" type="checkbox"/> 5KHz <input type="checkbox"/> 100KHz | | | | | | | | | |
| Coupling Line | | Test level (kV) | | | | | | | | Performance Criterion | Result |
| | | 0.5 | | 1 | | 2 | | 4 | | | |
| | | + | - | + | - | + | - | + | - | | |
| AC line | L | A | A | A | A | / | / | / | / | B | Pass |
| | N | A | A | A | A | / | / | / | / | | Pass |
| | L+N | A | A | A | A | / | / | / | / | | Pass |
| | L+PE | / | / | / | / | / | / | / | / | | N/A |
| | N+PE | / | / | / | / | / | / | / | / | | N/A |
| | L+N+PE | / | / | / | / | / | / | / | / | | N/A |
| Wired network Line | RJ45 | / | / | / | / | / | / | / | / | | Pass |
| Wired network | xDSL | / | / | / | / | / | / | / | / | N/A | |
| Signal Line | / | / | / | / | / | / | / | / | / | N/A | |
| DC Line | / | / | / | / | / | / | / | / | / | N/A | |

Note: "A" stand for, No degradation in performance of the EUT was observed.
 "B" stand for, Degradation in performance of the EUT occurred during the application of the disturbance, after the test, EUT can self-recovered and operate as intended.

| 7.4 Surge immunity test | |
|-----------------------------------|--|
| Acceptable Performance Criterion: | B |
| Test Level: | 0.5, 1kV Line to Neutral; 0.5, 1kV , 2kV Line to earth; 0.5, 1kV Wired network Line |
| Polarity: | Positive & Negative |
| Generator source impedance: | 2 Ω; |
| Trigger Mode: | Internal |
| No. of surges: | 5 positive & 5 negative at 0°, 90°, 180°, 270°. |

| 7.4.1 E.U.T. Operation | | | | | | |
|-------------------------------|-----------|-----------|--------|-----------------------|-----|-----|
| Temperature: | 25°C | Humidity: | 50% RH | Atmospheric Pressure: | 101 | Kpa |
| Test Mode: | All Modes | | | | | |

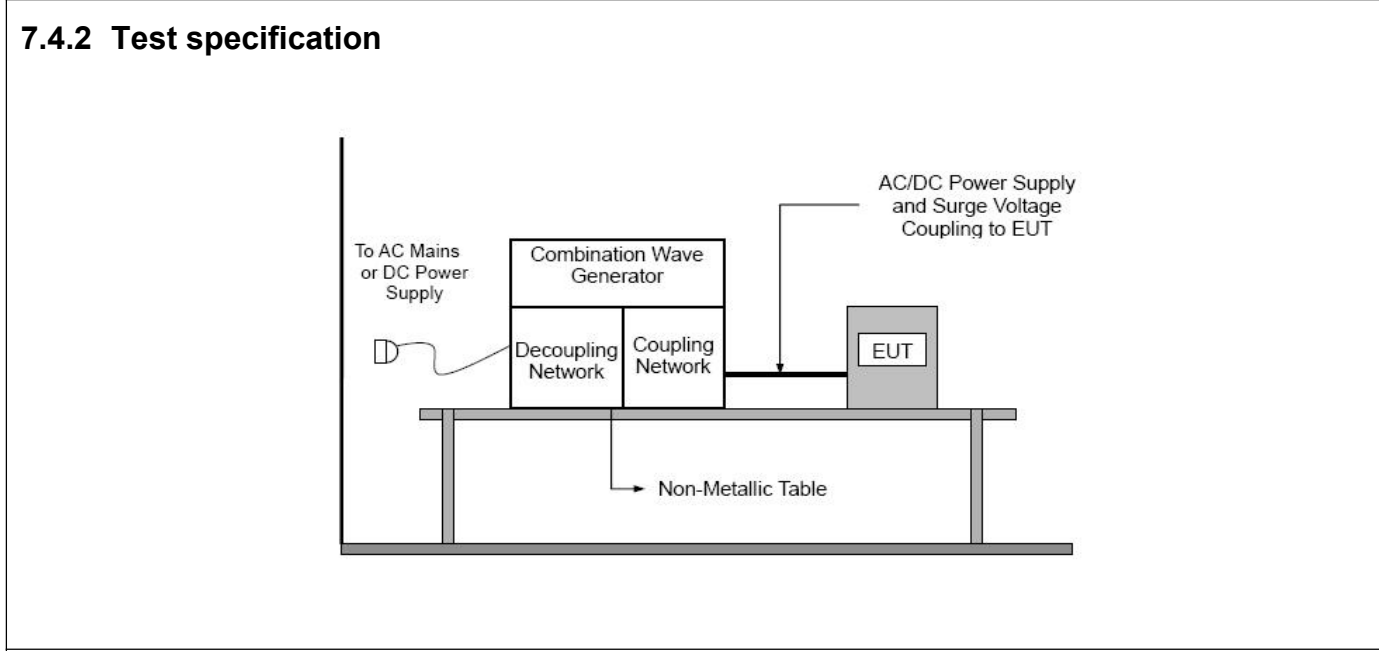

EUT was placed on a wooden table which is 0.8m above the ground and operated in the mode as mentioned above. The power cord between the EUT and the coupling/decoupling network was bundled so as to make it less than 2 m in length.

7.4.3 Measurement Data

Test Record

| Surge Immunity Test Result | | | | | | | | | | | | |
|----------------------------|-------|---|------------|---|------|---|------|---|------|---|-----------------------|--------|
| M/N: | | Active 8 | | | | Test Result: <input checked="" type="checkbox"/> Pass <input type="checkbox"/> Fail | | | | | | |
| Test Voltage: | | AC 230V/50Hz | | | | Test date: 2023-06-09 | | | | | | |
| Test Signal | | <input checked="" type="checkbox"/> 1.2/50 μ s <input type="checkbox"/> 10/700 μ s Interval: <u>60</u> seconds Pluse: <u>10</u> times | | | | | | | | | | |
| Coupling Line | | | Test level | | | | | | | | Performance Criterion | Result |
| | | | 0.5 kV | | 1 kV | | 2 kV | | 4 kV | | | |
| | | | + | - | + | - | + | - | + | - | | |
| AC line | L-N | 0° | A | A | A | A | / | / | / | / | B | Pass |
| | | 90° | A | A | A | A | / | / | / | / | | Pass |
| | | 180° | A | A | A | A | / | / | / | / | | Pass |
| | | 270° | A | A | A | A | / | / | / | / | | Pass |
| | L-P E | 0° | / | / | / | / | / | / | / | / | | N/A |
| | | 90° | / | / | / | / | / | / | / | / | | N/A |
| | | 180° | / | / | / | / | / | / | / | / | | N/A |
| | | 270° | / | / | / | / | / | / | / | / | | N/A |
| | N-PE | 0° | / | / | / | / | / | / | / | / | | N/A |
| | | 90° | / | / | / | / | / | / | / | / | | N/A |
| | | 180° | / | / | / | / | / | / | / | / | | N/A |
| | | 270° | / | / | / | / | / | / | / | / | | N/A |
| Wired network Line | RJ 45 | / | / | / | / | / | / | / | / | | Pass | |

Note: "A" stand for, No degradation in performance of the EUT was observed.
 "B" stand for, Degradation in performance of the EUT occurred during the application of the disturbance, after the test, EUT can self-recovered and operate as intended.

7.5 Conducted disturbance immunity Test

| | |
|-----------------------------------|---------------|
| Acceptable Performance Criterion: | A |
| Test Level | 3 V |
| Frequency Range | 0.15MHz~80MHz |

7.5.1 E.U.T. Operation

| | | | | | | |
|--------------|-----------|-----------|--------|-----------------------|-----|-----|
| Temperature: | 23°C | Humidity: | 55% RH | Atmospheric Pressure: | 101 | Kpa |
| Test Mode: | All Modes | | | | | |

7.5.2 Test specification

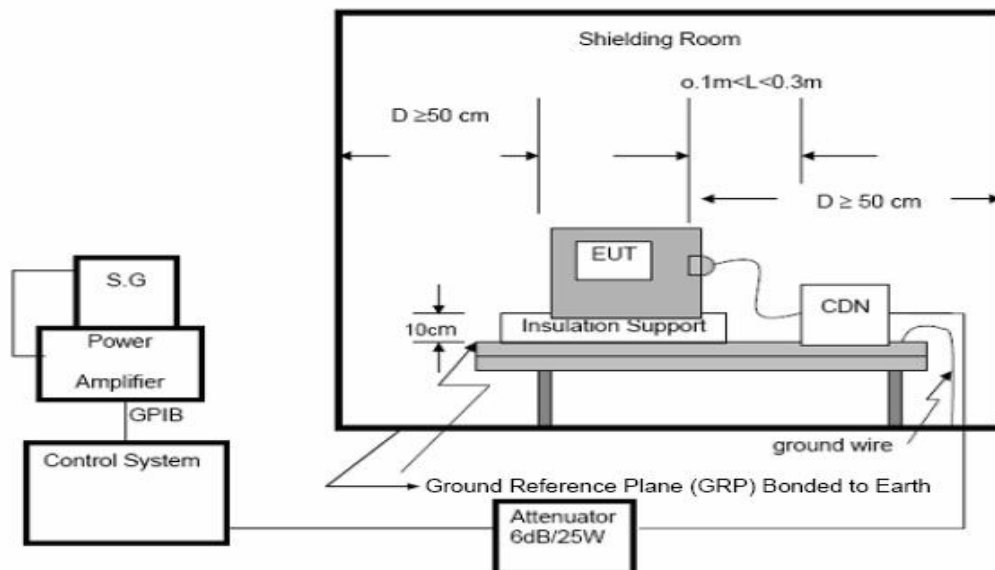

The equipment to be tested was placed on an insulating support of 0,1m height above a ground reference Plane. The minimum distance between the EUT and all other conductive structures, except the ground reference plane is more than 0.5m. All relevant cables were provided with the appropriate coupling and decoupling devices at a distance between 0.1m and 0.3m from the projected geometry of the EUT.

7.5.3 Measurement Data

Test Record

| Injected Currents Susceptibility Measurement Result | | | |
|---|--|---|---|
| M/N: | Active 8 | Test Result: <input checked="" type="checkbox"/> Pass <input type="checkbox"/> Fail | |
| Test Voltage: | AC 230V/50Hz | Test date: 2023-06-09 | |
| Test Port | <input checked="" type="checkbox"/> AC Port <input type="checkbox"/> Wired network <input type="checkbox"/> Signal Line <input type="checkbox"/> DC Port | | |
| Operating Mode | All Modes | | |
| Test Level (V) | <u>3</u> V(r.m.f) (unmodulated) | Criterion | A |

| Test Ports (Mode) | Freq. Range MHz) | Field Strength | Observation | Observations (Performance Criterion) | Results |
|------------------------------|------------------|--|---------------|--------------------------------------|------------|
| Input/ Output AC. Power Port | 0.15 ---80 | 3V(rms) AM Modulated 1000Hz, 80% | CT, CR | A | P |
| Wired network ports | 0.15 ---80 | | N/A | N/A | N/A |
| Input/ Output DC. Power Port | 0.15 --- 80 | | N/A | N/A | N/A |
| Signal Line | 0.15 --- 80 | | N/A | N/A | N/A |

Note: "A" stand for, during test, operate as intended no loss of function, no degradation of performance, no unintentional transmissions and after test, no degradation of performance, no loss of function, no loss of stored data or user programmable functions.

Special conditions for EMC immunity tests

| EUT operating Mode | PER during test(Worst) | PER Limit | Result |
|------------------------------------|------------------------|-----------|--------|
| BT | 4.02% | 10% | Pass |
| WIFI 2.4G | 4.41% | 10% | Pass |
| GSM/GPRS/EGPRS 900 MHz, Traffic | 4.00% | 10% | Pass |
| UMTS/HSPA 900 MHz, Traffic | 4.11% | 10% | Pass |
| LTE BAND 1 Traffic | 3.59% | 10% | Pass |
| LTE BAND 3 Traffic | 5.73% | 10% | Pass |
| LTE BAND 7 Traffic | 4.10% | 10% | Pass |
| LTE BAND 8 Traffic | 4.62% | 10% | Pass |
| LTE BAND 20 Traffic | 4.91% | 10% | Pass |

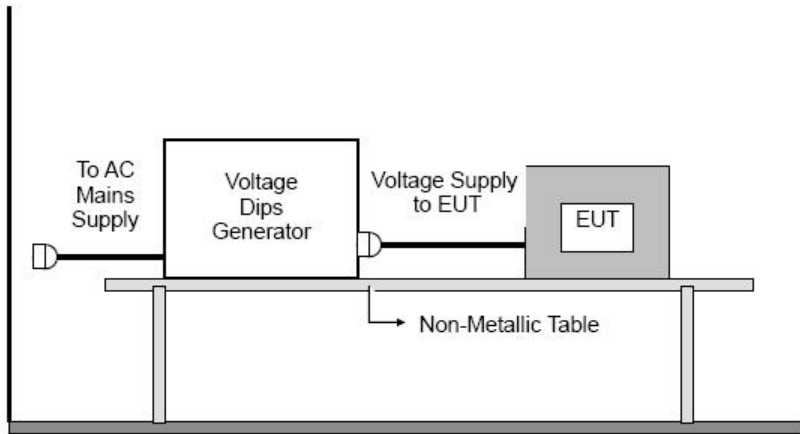
| | | | | | | |
|--|-----------|---|--------|-----------------------|-----|-----|
| 7.6 Voltage dips and interruptions immunity test | | | | | | |
| Acceptable Performance Criterion: | | B & C | | | | |
| Test Level: | | <5% of U_T (Supply Voltage) for 0.5 and 250 Periods | | | | |
| | | 70 % of U_T (Supply Voltage) for 25 Periods | | | | |
| No. of Dips / Interruptions: | | 3 per Level | | | | |
| 7.6.1 E.U.T. Operation | | | | | | |
| Temperature: | 25°C | Humidity: | 50% RH | Atmospheric Pressure: | 101 | Kpa |
| Test Mode: | All Modes | | | | | |
| 7.6.2 Test specification | | | | | | |
|  | | | | | | |
| <p>EUT connected to the test generator with the shortest power supply cable as specified by the EUT manufacturer. The rated voltage of the EUT was used as the basis for voltage test level specification. After each group of tests, a full functional check was performed.</p> | | | | | | |

7.6.3 Measurement Data

Test Record

| Voltage Dips And Interruptions Test Result | | | | | | |
|---|---|----------------|-------|---|-----------|--------|
| M/N: | Active 8 | | | Test Result: <input checked="" type="checkbox"/> Pass <input type="checkbox"/> Fail | | |
| Test Voltage: | AC 230V/50Hz | | | Test date: 2023-06-09 | | |
| Test Port | <input checked="" type="checkbox"/> AC Port | | | | | |
| Level (%U _T) | Interruption & Dips (%U _T) | Duration (Cyc) | Phase | Test result | Criterion | Result |
| 70 | 30 | 25 | 0 | B | C | Pass |
| 0 | 100 | 0.5 | 0 | A | B | Pass |
| 0 | 100 | 1.0 | 0 | A | B | Pass |
| 0 | 100 | 250 | 0 | B | C | Pass |
| <p>Note: "A" stands for, No degradation in performance of the EUT was observed. "B" stands for, Degradation in performance of the EUT occurred during the application of the disturbance, after the test, EUT can self-recovered and operate as intended. "C" stands for, Loss of function of the EUT occurred during the application of the disturbance, after the test, EUT can self-recovered or restored by manually and operate as intended.</p> | | | | | | |

8 Test Setup Photos of The EUT

Radiated Emission

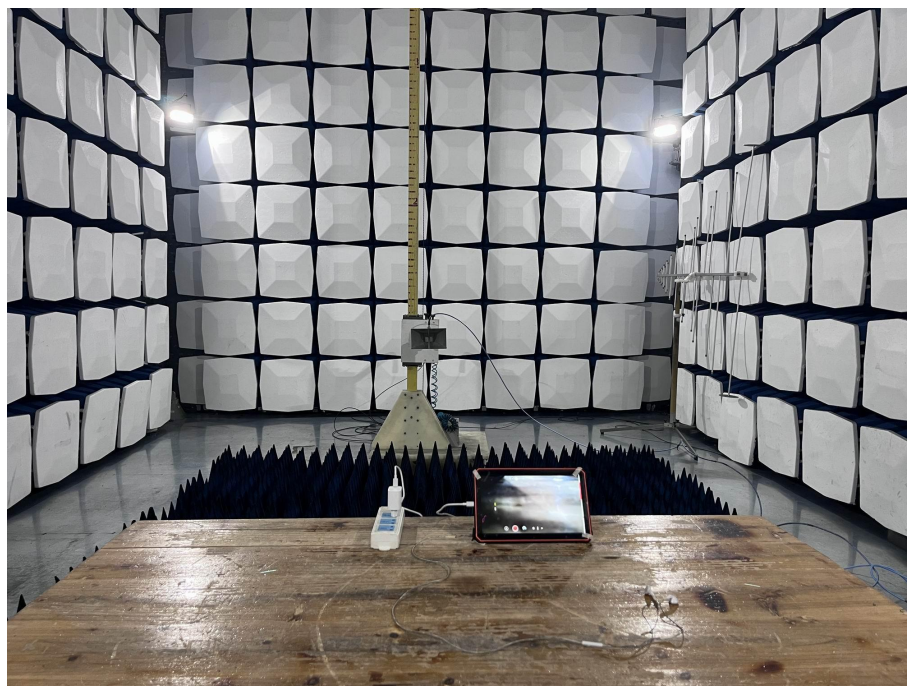
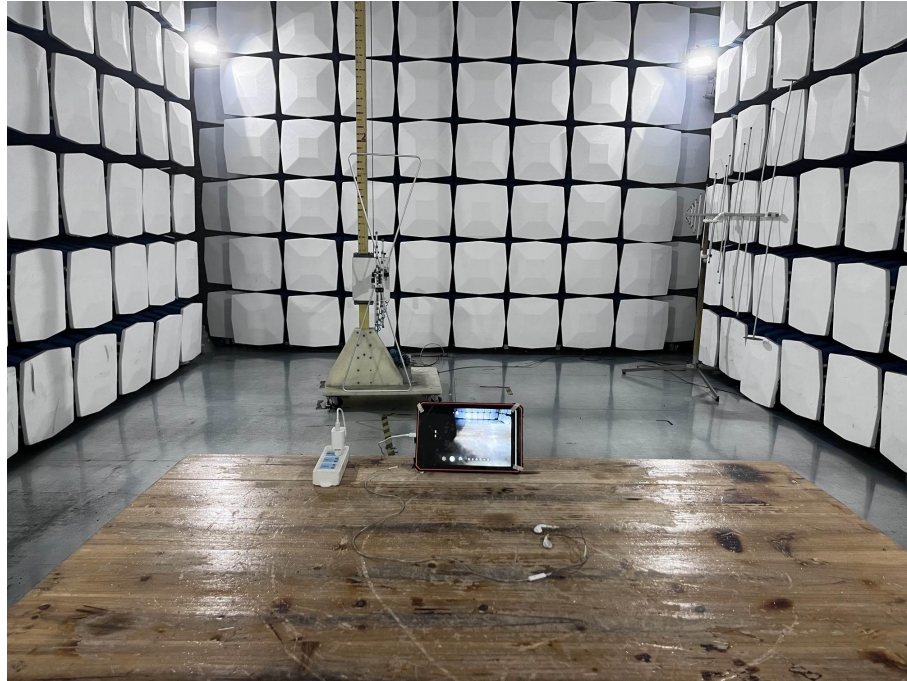

Conducted Emission(AC Mains)



Harmonic Current/ Voltage Fluctuation and Flicker



Electrostatic Discharge



RF Electromagnetic Field

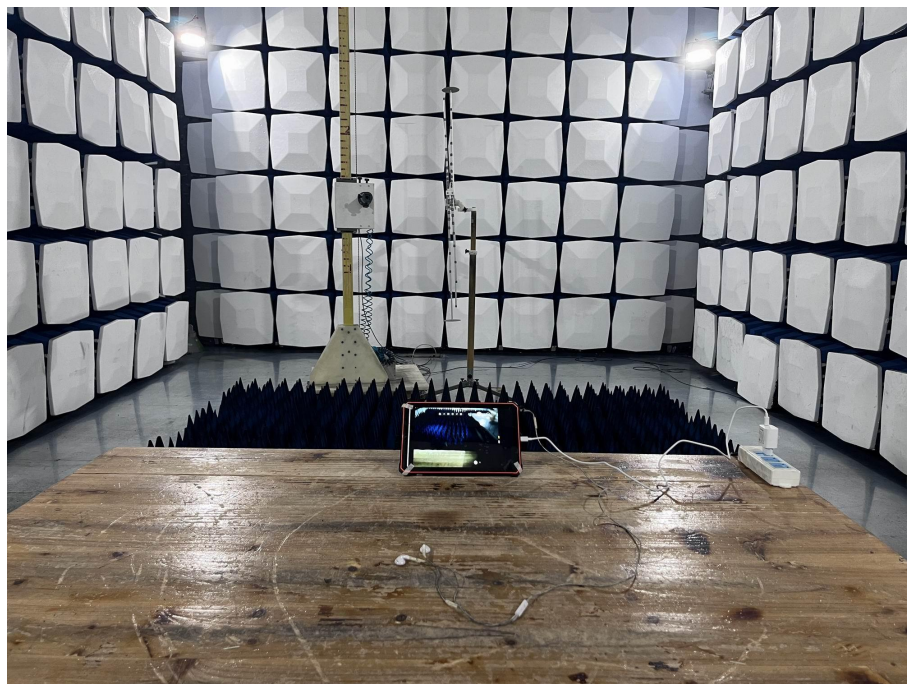

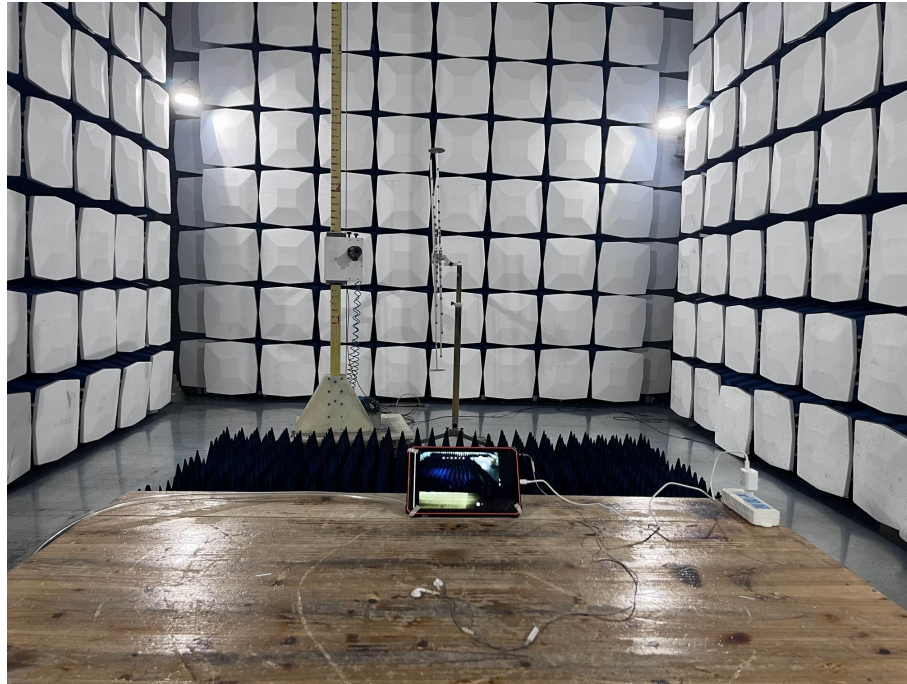

RF Common Mode 0,15 MHz to 80 MHz

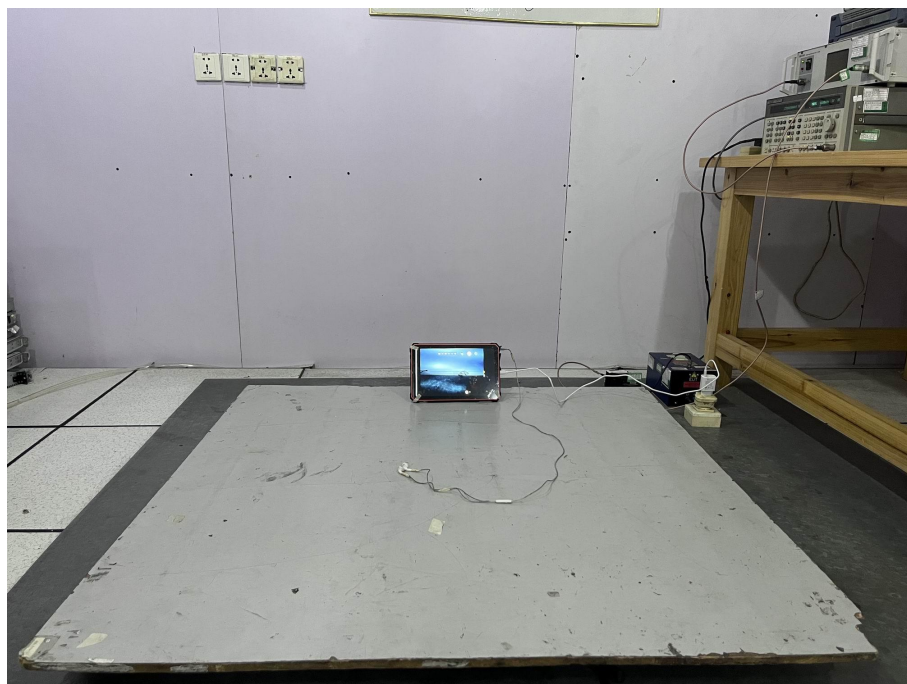

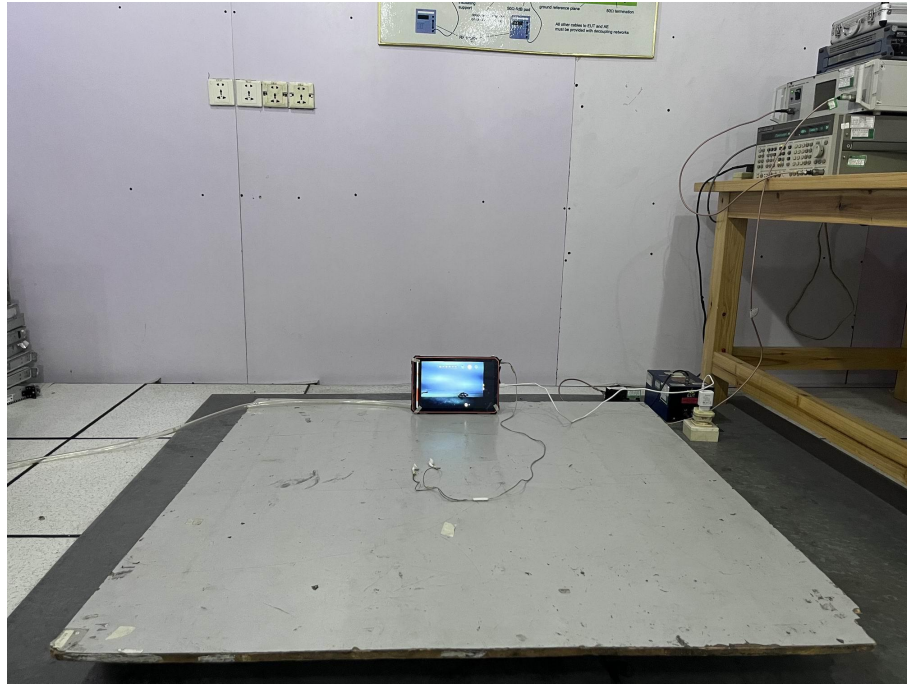

Fast Transients Common Mode & Surge & DIPS

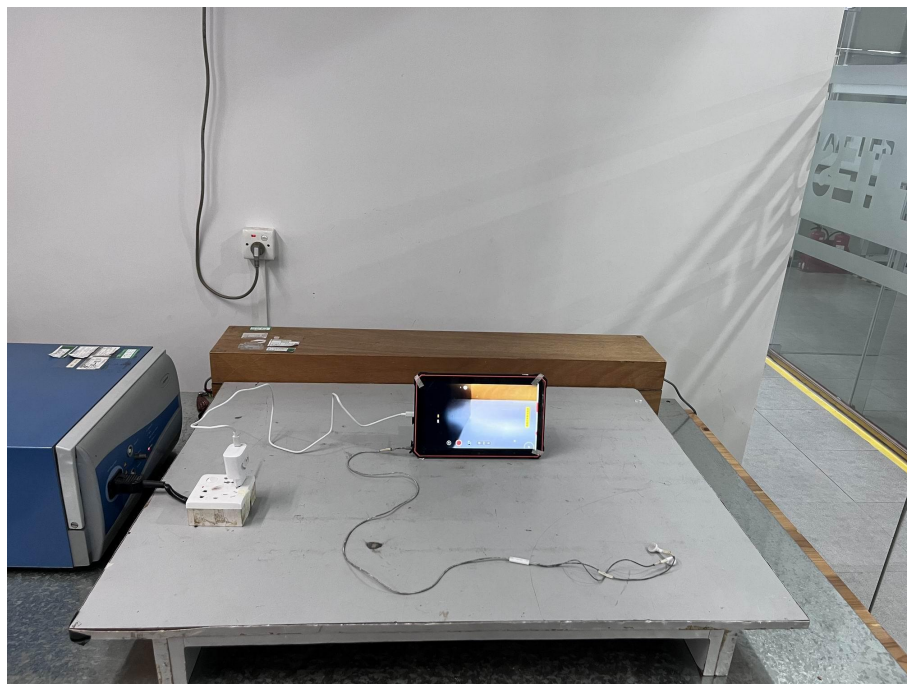

9 External And Internal Photos of The EUT

Please refer to the appendix for details

****End of the report****