

Radio Test Report-5G WIFI

ETSI EN 301 893 V2.1.1 (2017-05)

Client Information:

Applicant: DOKE COMMUNICATION (HK) LIMITED
Applicant add.: RM 1902 EASEY COMM BLDG 253-261 HENNESSY ROAD WANCHAI HK CHINA

Product Information:

Product Name: Tablet
Model No.: Tab 70 WiFi
Serial Model: N/A
Brand Name: Blackview
Report No.: AIT23071307CW4

Prepared By:

Dongguan Yaxu (AiT) Technology Limited

No.22, Jinqianling Third Street, Jitigang, Huangjiang, Dongguan,
Guangdong, China

Tel.: +86-769-8202 0499 Fax.: +86-769-8202 0495

Date of Receipt: July 13, 2023

Date of Test: July 13, 2023~July 26, 2023

Date of Issue: July 27, 2023

Test Result: Pass

This device has been tested and found to comply with the stated standard(s), which is (are) required by the council directive of 2014/53/EU and indicated in the test report and are applicable only to the tested sample identified in the report.

Note: This report shall not be reproduced except in full, without the written approval of Dongguan Yaxu (AiT) Technology Limited, this document may be altered or revised by Dongguan Yaxu (AiT) Technology Limited, personal only, and shall be noted in the revision of the document. This test report must not be used by the client to claim product endorsement.

Reviewed by:



Simba huang

Approved by:



Seal.chen



1 Contents

	Page
COVER PAGE	
1 CONTENTS	2
2 TEST SUMMARY	3
2.1 Measurement Uncertainty	4
3 TEST FACILITY	5
3.1 Deviation from standard	5
3.2 Abnormalities from standard conditions	5
3.3 Test Location	5
4 GENERAL INFORMATION	6
4.1 EUT Peripheral List	8
4.2 Peripheral List	8
5 EQUIPMENT USED DURING TEST	9
6 RADIO TECHNICAL SPECIFICATION IN EN 301 893 V2.1.1	10
6.1 Transmitter Requirements	10
6.1.1 Centre frequencies	10
6.1.2 Nominal Channel Bandwidth and Occupied Channel Bandwidth	12
6.1.3 RF output power, Transmit Power Control (TPC) and Power Density	23
6.1.4 Transmitter unwanted emissions outside the 5 GHz RLAN bands	29
6.1.5 Transmitter unwanted emissions within the 5 GHz RLAN bands	34
6.1.6 Receiver spurious emissions	39
6.1.7 Adaptivity (Channel Access Mechanism)	42
6.1.8 Receiver Blocking	48
7 PHOTOGRAPHS	50
7.1 Spurious Emission Test Setup (below 1GHz)	50
7.2 Spurious Emission Test Setup (above 1GHz)	50

2 Test Summary

Radio Spectrum Matter (RSM) Part				
Transmitter Parameters				
Test Item	Test Requirement	Test Method	Limit	Result
Centre frequencies	EN 301 893 (2017-05) V2.1.1 Clause 4.2.1	EN 301 893 (2017-05) V2.1.1 Clause 5.4.2	Refer clause 4.2.1.3	PASS
Nominal Channel Bandwidth and Occupied Channel Bandwidth	EN 301 893 (2017-05) V2.1.1 Clause 4.2.2	EN 301 893 (2017-05) V2.1.1 Clause 5.4.3	Refer clause 4.2.2.2	PASS
RF output power	EN 301 893 (2017-05) V2.1.1 Clause 4.2.3	EN 301 893 (2017-05) V2.1.1 Clause 5.4.4	Refer clause 4.2.3.2	PASS
Transmit Power Control (TPC)	EN 301 893 (2017-05) V2.1.1 Clause 4.2.3	EN 301 893 (2017-05) V2.1.1 Clause 5.4.4	Refer clause 4.2.3.2	N/A
Power Density	EN 301 893 (2017-05) V2.1.1 Clause 4.2.3	EN 301 893 (2017-05) V2.1.1 Clause 5.4.4	Refer clause 4.2.3.2	PASS
Transmitter unwanted emissions outside the 5 GHz RLAN bands	EN 301 893 (2017-05) V2.1.1 Clause 4.2.4	EN 301 893 (2017-05) V2.1.1 Clause 5.4.5	Refer clause 4.2.4.1.2	PASS
Transmitter unwanted emissions within the 5 GHz RLAN bands	EN 301 893 (2017-05) V2.1.1 Clause 4.2.4	EN 301 893 (2017-05) V2.1.1 Clause 5.4.6	Refer clause 4.2.4.2.2	PASS
DFS: Dynamic Frequency Selection	EN 301 893 (2017-05) V2.1.1 Clause 4.2.6	EN 301 893 (2017-05) V2.1.1 Clause 5.4.8	Refer clause 4.2.6	N/A (Remark)
Adaptivity (Channel Access Mechanism)	EN 301 893 (2017-05) V2.1.1 Clause 4.2.7	EN 301 893 (2017-05) V2.1.1 Clause 5.4.9	Refer clause 4.2.7.3	PASS
Geo-location capability	EN 301 893 (2017-05) V2.1.1 Clause 4.10	NA	NA	This test is not required since the device does not support this function

Receiver Parameters				
Receiver spurious emissions	EN 301 893 (2017-05) V2.1.1 Clause 4.6	EN 301 893 (2017-05) V2.1.1 Clause 5.4.7	Refer clause 4.2.5.2	PASS
Receiver Blocking	EN 301 893 (2017-05) V2.1.1 Clause 4.2.8	EN 301 893 (2017-05) V2.1.1 Clause 5.4.10	Refer clause 4.2.8.4	PASS

Remark:

The EUT in this report is a slave without radar detection.

Tx: In this whole report Tx (or tx) means Transmitter.

Rx: In this whole report Rx (or rx) means Receiver.

RF: In this whole report RF means Radiated Frequency.

CH: In this whole report CH means channel.

Volt: In this whole report Volt means Voltage.

Temp: In this whole report Temp means Temperature.

Humid: In this whole report Humid means humidity.

Press: In this whole report Press means Pressure.

N/A: In this whole report not application

This device operating frequency is 5.15GHz-5.25GHz, "Dynamic Frequency Selection" was not application in this test report.

2.1 Measurement Uncertainty

No.	Item	Uncertainty
1	Conducted Emission Test	1.20dB
2	Radiated Emission Test	3.30dB
3	RF power,conducted	0.16dB
4	RF power density,conducted	0.24dB
5	Spurious emissions,conducted	0.21dB
6	All emissions,radiated(<1G)	4.68dB
7	All emissions,radiated(>1G)	4.89dB

3 Test Facility

The test facility is recognized, certified or accredited by the following organizations:

.CNAS- Registration No: L6177

Dongguan Yaxu (AiT) technology Limited is accredited to ISO/IEC 17025:2017 general Requirements for the competence of testing and calibration laboratories (CNAS-CL01 Accreditation Criteria for the competence of testing and calibration laboratories) on April 18, 2022

FCC-Registration No.: 703111 Designation Number: CN1313

Dongguan Yaxu (AiT) technology Limited has been registered and fully described in a report filed with the (FCC) Federal Communications Commission. The acceptance letter from the FCC is maintained in our files.

IC —Registration No.: 6819A CAB identifier: CN0122

The 3m Semi-anechoic chamber of Dongguan Yaxu (AiT) technology Limited has been registered by Certification and Engineering Bureau of Industry Canada for radio equipment testing with Registration No.: 6819A

A2LA-Lab Cert. No.: 6317.01

Dongguan Yaxu (AiT) technology Limited has been accredited by A2LA for technical competence in the field of electrical testing, and proved to be in compliance with ISO/IEC 17025: 2017 General Requirements for the Competence of Testing and Calibration Laboratories and any additional program requirements in the identified field of testing.

3.1 Deviation from standard

None

3.2 Abnormalities from standard conditions

None

3.3 Test Location

All tests were performed at:

Dongguan Yaxu (AiT) Technology Limited

No.22, Jinqianling Third Street, Jitigang, Huangjiang, Dongguan, Guangdong, China.

Tel.: +86.769.82020499 Fax.: +86.769.82020495

4 General Information

Manufacturer:	Shenzhen DOKE Electronic Co.,Ltd
Manufacturer Address:	801, Building3, 7th Industrial Zone, Yulv Community, Yutang Road, Guangming District, Shenzhen, China.
EUT Name:	Tablet
Model No:	Tab 70 WiFi
Serial Model:	N/A
Brand Name:	Blackview
Operating Frequency	5.18GHz-5.24GHz
Type of Modulation:	IEEE for 802.11a: OFDM (BPSK/QPSK/16QAM/64QAM) IEEE for 802.11n: OFDM (BPSK/QPSK/16QAM/64QAM) IEEE for 802.11ac/ax:OFDM (QPSK/BPSK/16QAM/64QAM/256QAM)
Number of Channels	Please see Channel List.
Duty Cycle:	Continuous operation possible for testing purposes
Antenna Type	FPC Antenna
Antenna Gain:	-1.7dBi
H/W No.:	R863T-RK3562-V1.0
S/W No.:	Tab_70_WiFi_EEA_R863T_V1.0_20230713V01
Adapter:	Adapter: QZ-01000EA00 INPUT:100-240V 50/60Hz 0.3A Max OUTPUT:5V2A(10.0W)
Battery:	3.8V 6580mAh
Model difference:	N/A
Note:	
	1. For a more detailed features description, please refer to the manufacturer's specifications or the User's Manual.

Channel List							
802.11a/n/ac/ax(20MHz) (5.15-5.25GHz)							
Channel	Frequency (MHz)	Channel	Frequency (MHz)	Channel	Frequency (MHz)	Channel	Frequency (MHz)
36	5180	40	5200	44	5220	48	5240
802.11n/ac/ax(40MHz) (5.15-5.25GHz)							
Channel	Frequency (MHz)	Channel	Frequency (MHz)	Channel	Frequency (MHz)	Channel	Frequency (MHz)
38	5190	42	5210	46	5230	--	--
40	5200	44	5220	--	--	--	--
802.11 ac/ax(80MHz) (5.15-5.25GHz)							
Channel	Frequency (MHz)	Channel	Frequency (MHz)	Channel	Frequency (MHz)	Channel	Frequency (MHz)
42	5210	--	--	--	--	--	--

4.1 EUT Peripheral List

No.	Equipment	Manufacturer	Model No.	Serial No.	signal cable	Remark
1	Adapter	Guangdong Quanzhi Technology Co., Ltd.	QZ-01000EA00	N/A	N/A	N/A

4.2 Peripheral List

No.	Equipment	Manufacturer	EMC Compliance	Model No.	Serial No.	Power cord	signal cable
1	N/A	N/A	N/A	N/A	N/A	N/A	N/A

5 Equipment Used during Test

No	Test Equipment	Manufacturer	Model No	Serial No	Cal. Date	Cal. Due Date
1	Spectrum Analyzer	R&S	FSV40	101470	2022.09.02	2023.09.01
2	EMI Measuring Receiver	R&S	ESR	101160	2022.09.02	2023.09.01
3	Low Noise Pre Amplifier	HP	HP8447E	AiT-F01319	2022.09.02	2023.09.01
4	Low Noise Pre Amplifier	Tsj	MLA-0120-A02-34	2648A04738	2022.09.02	2023.09.01
5	Passive Loop	ETS	6512	00165355	2022.09.04	2024.09.03
6	TRILOG Super Broadband test Antenna	SCHWARZBECK	VULB9160	9160-3206	2021.08.29	2024.08.28
7	Broadband Horn Antenna	SCHWARZBECK	BBHA9120D	452	2021.08.29	2024.08.28
8	SHF-EHF Horn Antenna 15-40GHz	SCHWARZBECK	BBHA9170	BBHA9170367d	2020.11.24	2023.11.23
9	EMI Test Receiver	R&S	ESCI	100124	2022.09.02	2023.09.01
10	LISN	Kyoritsu	KNW-242	8-837-4	2022.09.02	2023.09.01
11	LISN	R&S	ESH3-Z2	0357.8810.54 - 101161-S2	2022.09.02	2023.09.01
12	Pro.Temp&Humi.chamber	MENTEK	MHP-150-1C	MAA08112501	2022.09.02	2023.09.01
13	RF Automatic Test system	MW	MW100-RFCB	21033016	2022.09.02	2023.09.01
14	Signal Generator	Agilent	N5182A	MY50143009	2022.09.02	2023.09.01
15	Wideband Radio communication tester	R&S	CMW500	1201.0002K50	2022.09.02	2023.09.01
16	RF Automatic Test system	MW	MW100-RFCB	21033016	2022.09.02	2023.09.01
17	DC power supply	ZHAOXIN	RXN-305D-2	28070002559	N/A	N/A
18	RE Software	EZ	EZ-EMC_RE	Ver.AIT-03A	N/A	N/A
19	CE Software	EZ	EZ-EMC_CE	Ver.AIT-03A	N/A	N/A
20	RF Software	MW	MTS 8310	2.0.0.0	N/A	N/A

6 Radio Technical Specification in EN 301 893 V2.1.1

6.1 Transmitter Requirements

The EUT is intended for general use only and with a temporary antenna.

6.1.1 Centre frequencies

Test Requirement: EN 301 893 Clause 4.2.1

Test Method: EN 301 893 Clause 5.4.2

EUT Operation:

Ambient: Temp.: 25.0 °C Humid.: 56 % Press.: 1013 mbar

- Test Status:
- 1) Enter test mode (802.11a, 802.11n and 802.11ac) for the product, and report the worst data of 802.11a, 802.11n20 802.11n40 and 802.11ac.
 - 2) Pretest all mode, and report the worst data.
 - 3) These measurements shall be performed under both normal and extreme test conditions.

Equipment Used: Refer to section 5 for details.

Test Setup:

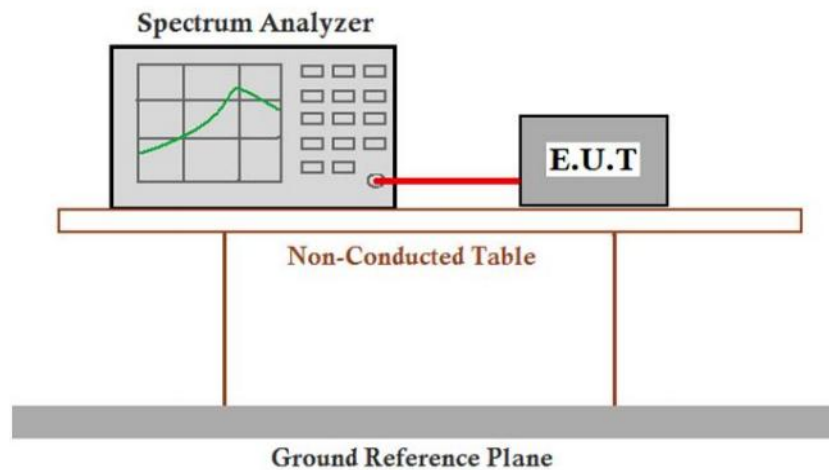

Limit: $-20 \text{ ppm} < f_c < 20 \text{ ppm}$

Test Data:

Mode	Frequency (MHz)	Measured Frequency (MHz)	Frequency Error (Hz)	Deviation (ppm)	Limit (ppm)	Verdict
a	5180	5179.9	-100000	-19.31	25	Pass
a	5200	5199.9	-100000	-19.23	25	Pass
a	5240	5239.92	-80000	-15.27	25	Pass
n40	5190	5189.92	-80000	-15.41	25	Pass
n40	5230	5229.88	-120000	-22.94	25	Pass
ac80	5210	5209.92	-80000	-15.36	25	Pass

6.1.2 Nominal Channel Bandwidth and Occupied Channel Bandwidth

Test Requirement: EN 301 893 Clause 4.2.2

Test Method: EN 301 893 Clause 5.4.3

EUT Operation:

Ambient: Temp.: 25.0 °C Humid.: 56 % Press.: 1013 mbar

- Test Status:
- 1) Enter test mode (802.11a, 802.11n and 802.11ac) for the product, and report the datas of 802.11a, 802.11n20, 802.11ac20, 802.11ax20, 802.11n40, 802.11ac40, 802.11ax40, 802.11ac80 and 802.11ax80.
 - 2) Pretest all mode, and report the worst data.
 - 3) These measurements shall be verified only under normal operating conditions.

Equipment Used: Refer to section 5 for details.

Test Setup:

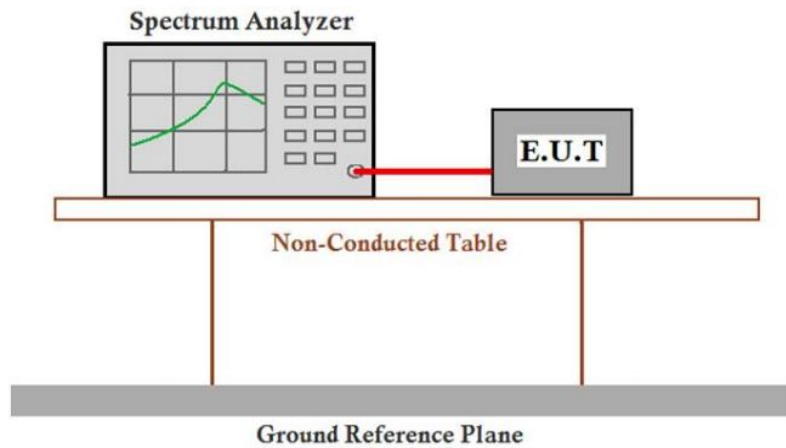

Limit: Nominal Channel Bandwidth \geq 5 MHz
 $80\% < \text{Occupied Channel Bandwidth} / \text{Nominal Channel Bandwidth} < 100\%$

Test Data:

Modulation Mode	Frequency (MHz)	Occupied Channel Bandwidth (MHz)	Occupied Channel Bandwidth Limit (MHz) (80-100% of Nominal channel bandwidth)
802.11a	5180	16.502	16-20
	5240	16.506	16-20
802.11n HT 20	5180	17.706	16-20
	5240	17.71	16-20
802.11nHT 40	5190	36.252	32-40
	5230	36.268	32-40
802.11ac VHT 20	5180	17.714	16-20
	5240	17.706	16-20
802.11ac VHT 40	5190	36.252	64-80
	5230	36.26	64-80
802.11ac VHT 80	5210	75.272	64-80
802.11ax HE 20	5180	18.994	16-20
	5240	18.99	16-20
802.11ax HE 40	5190	37.78	64-80
	5230	37.788	64-80
802.11ax HE 80	5210	77.16	64-80
Remark:			
Percentage Proportion Calculation = Occupied Channel Bandwidth / Nominal Channel Bandwidth			

802.11a

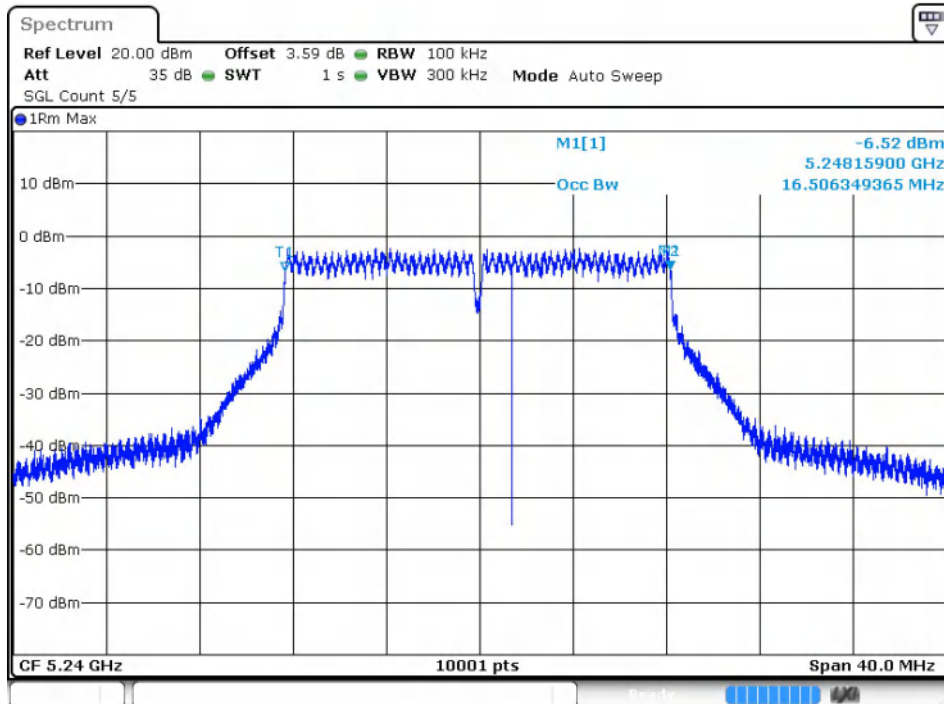
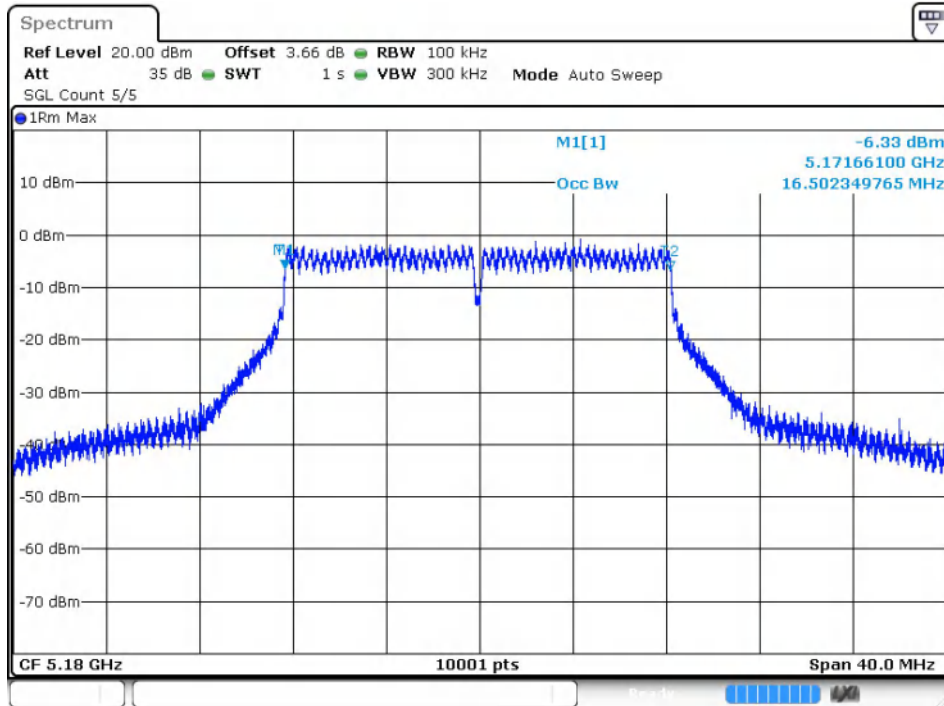

802.11n20

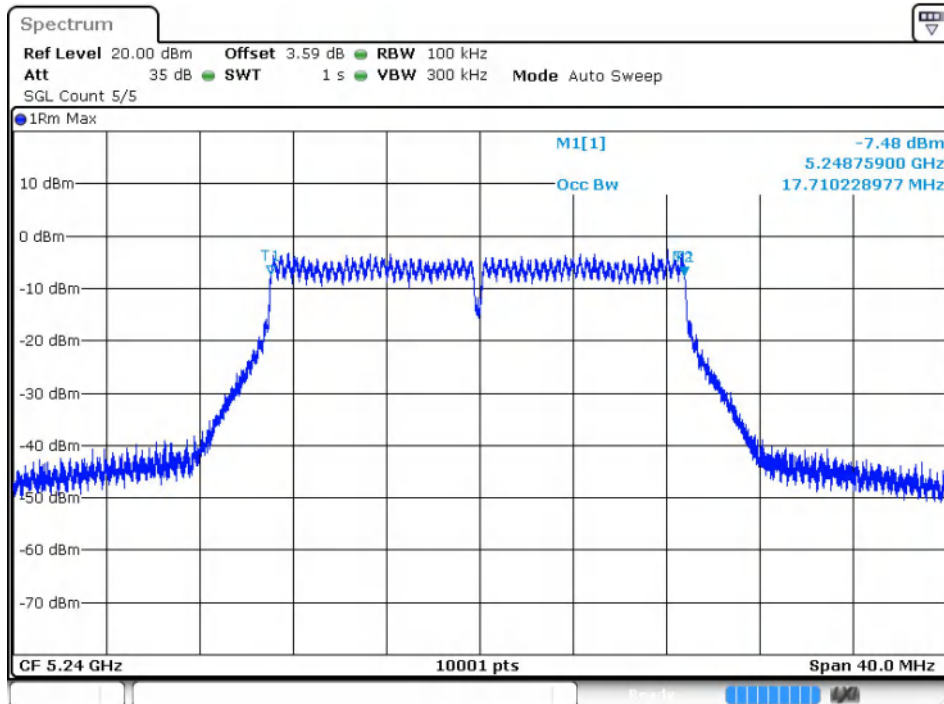
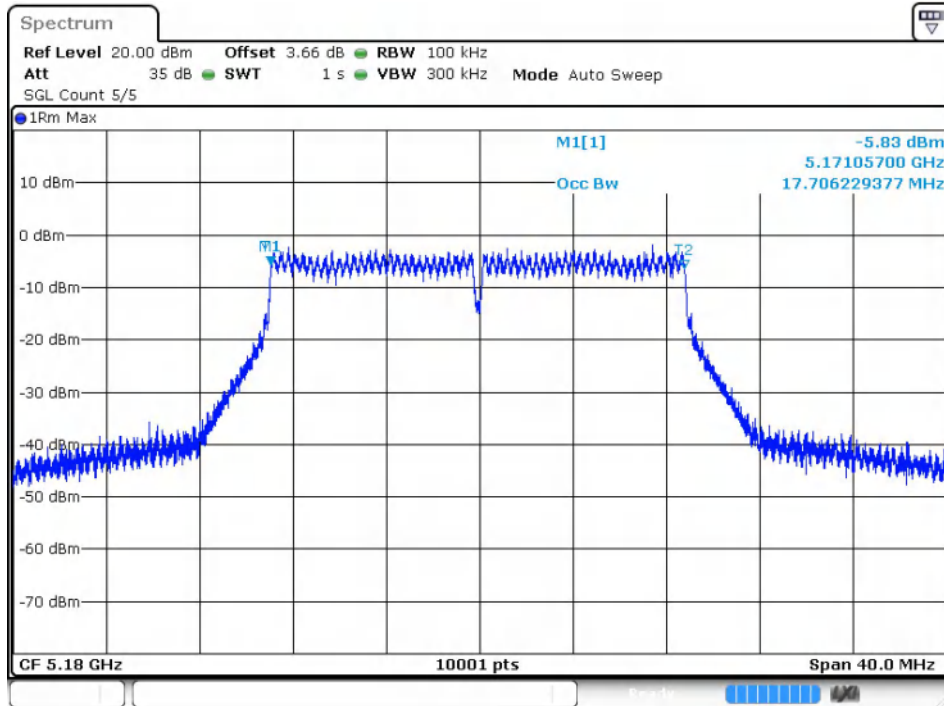

802.11n40

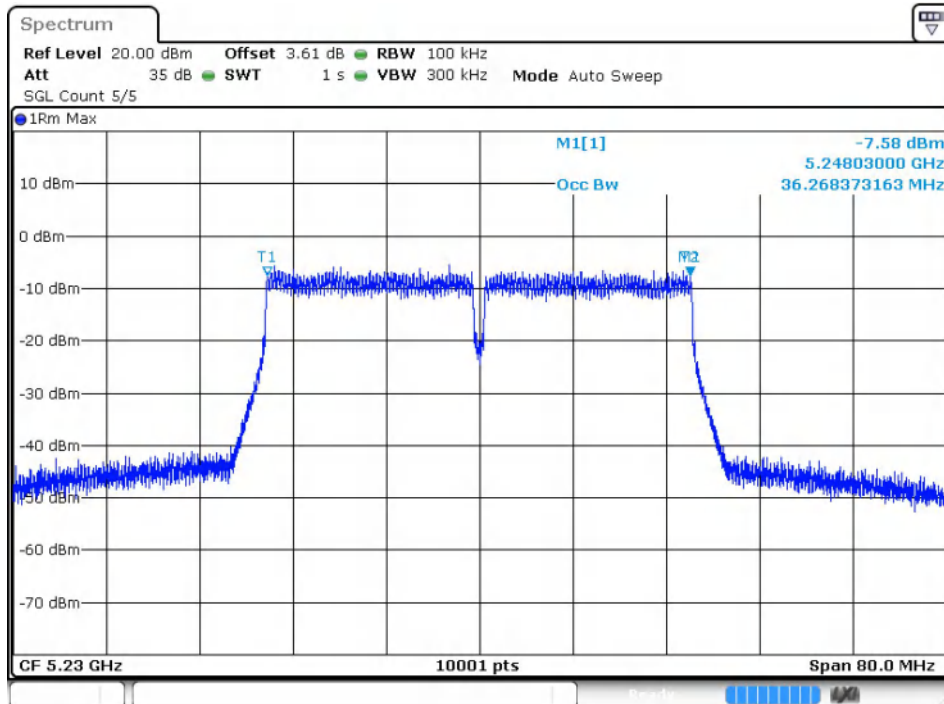
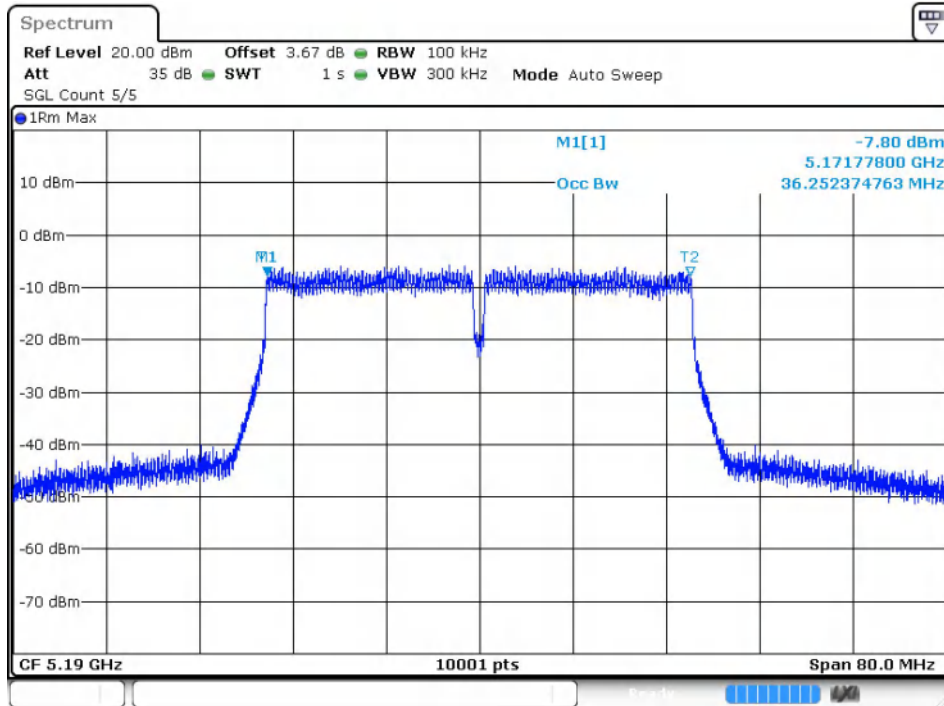

802.11ac20

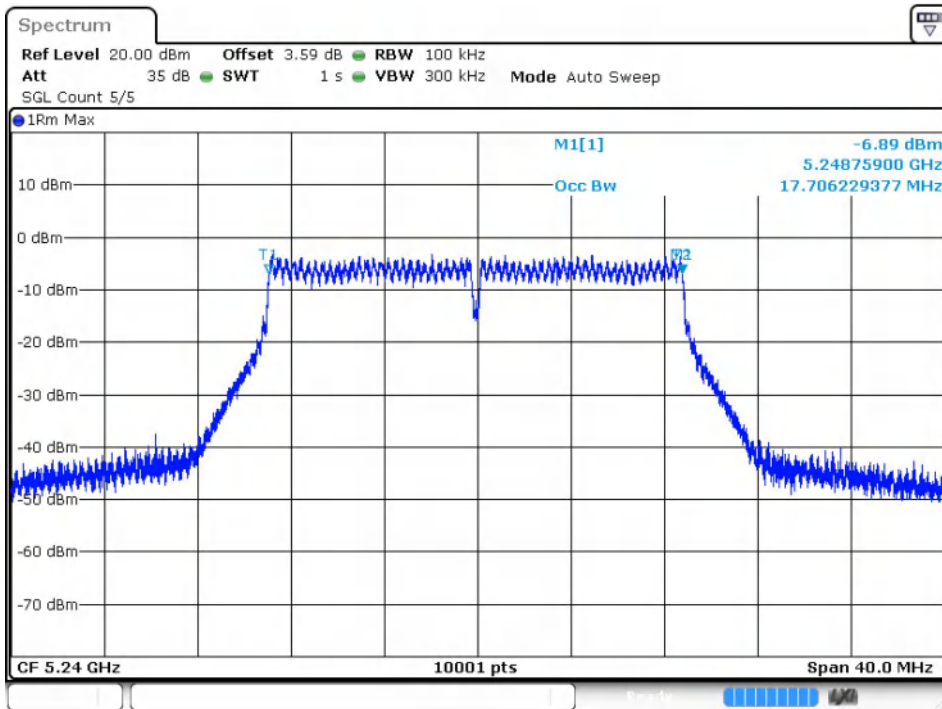
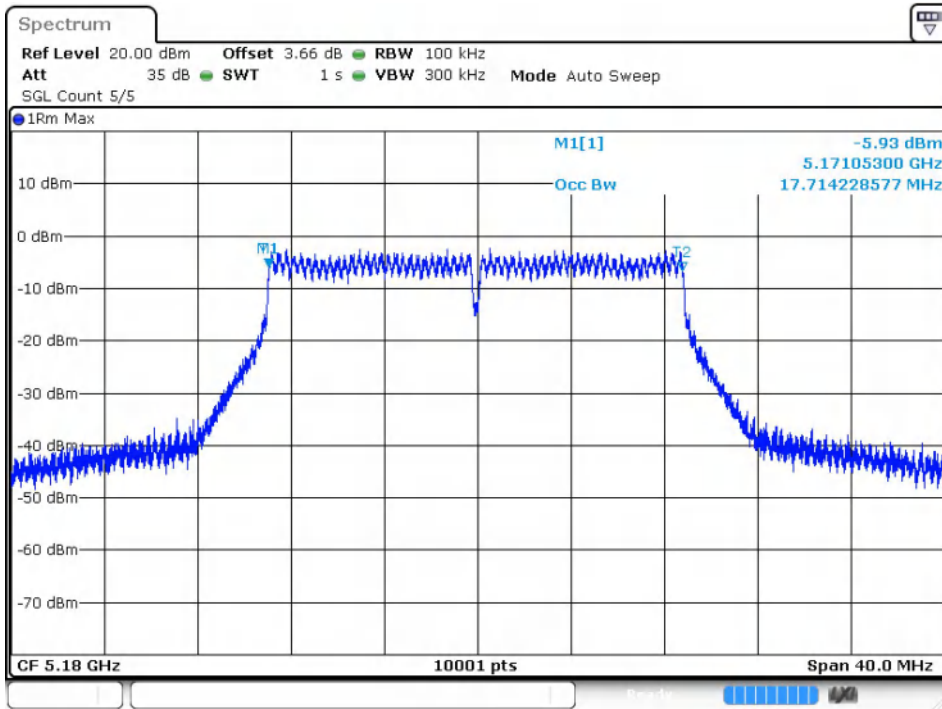

802.11ac40

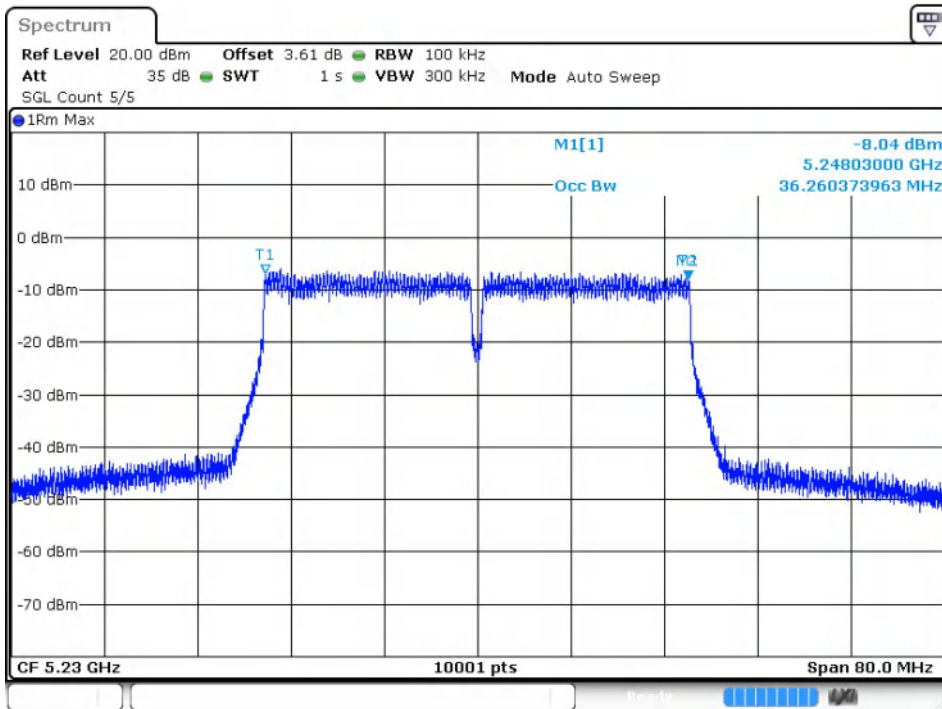
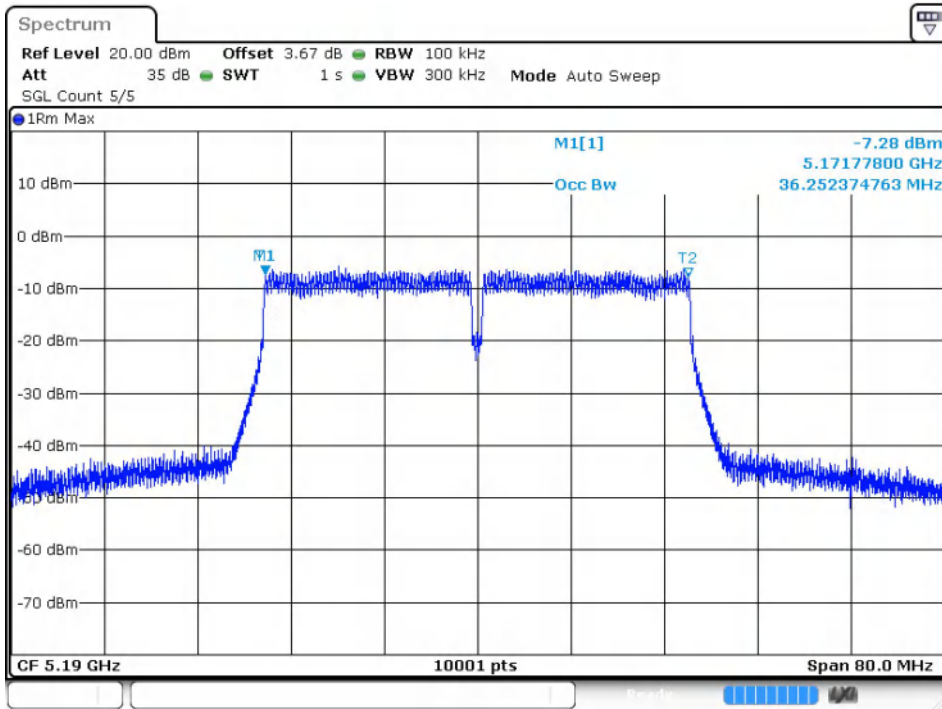

802.11ac80

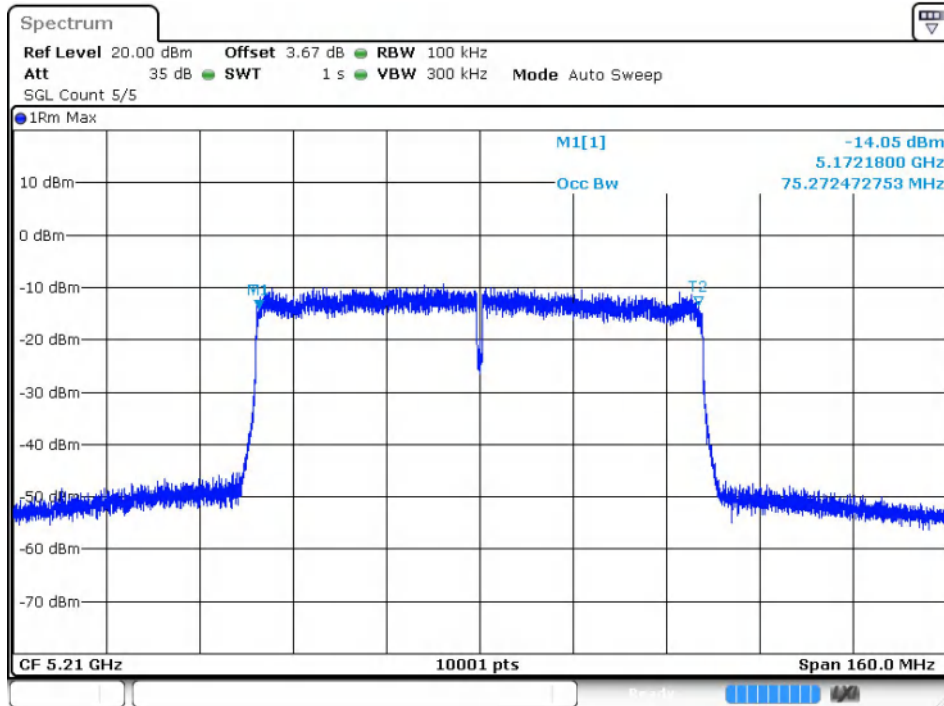

802.11ax20

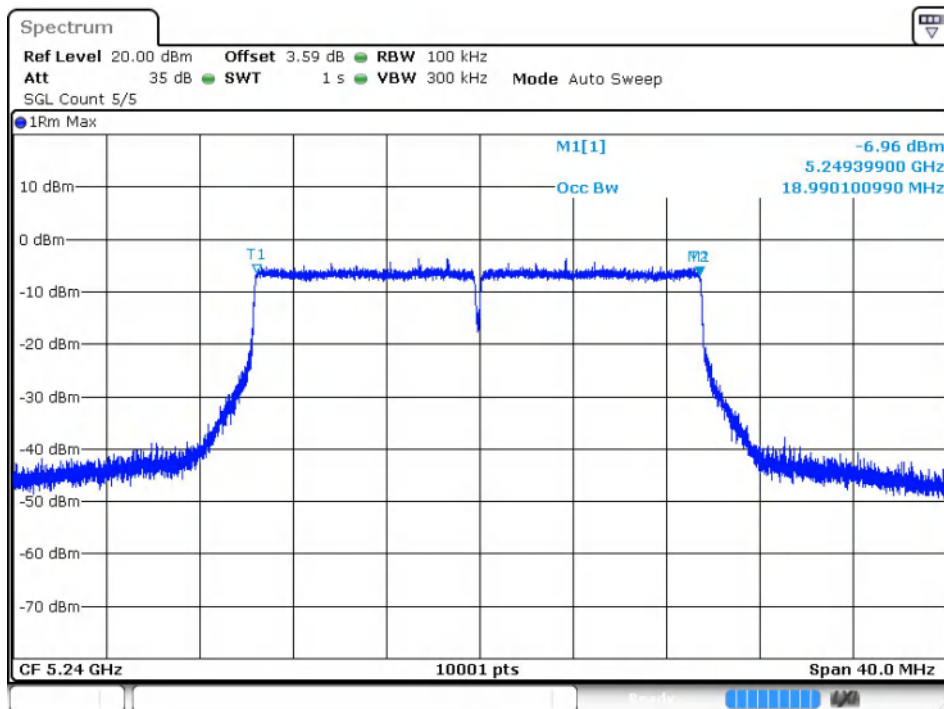
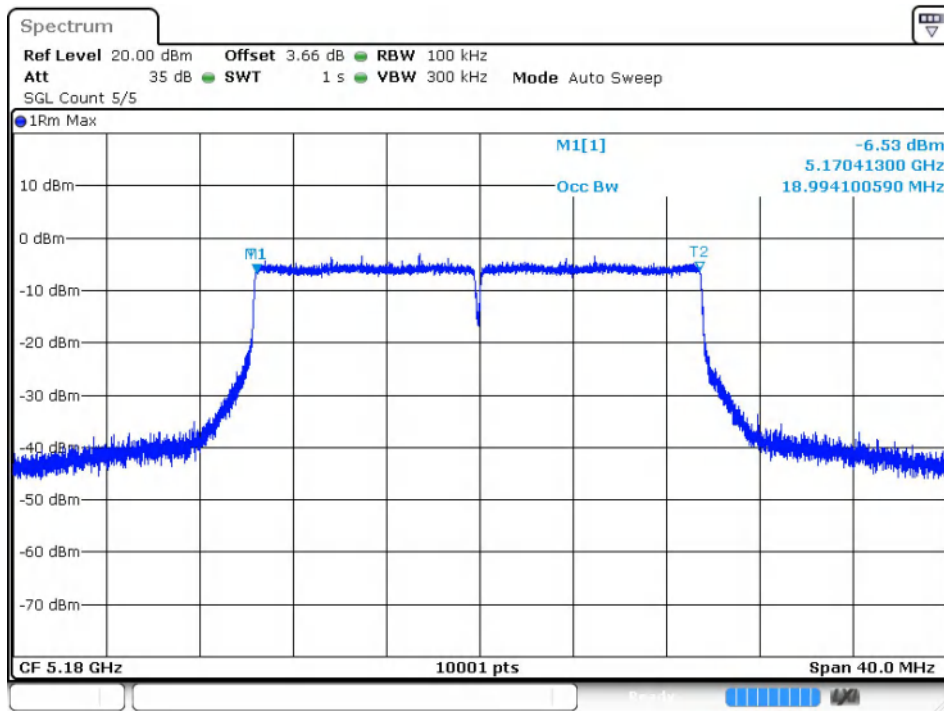

802.11ax40

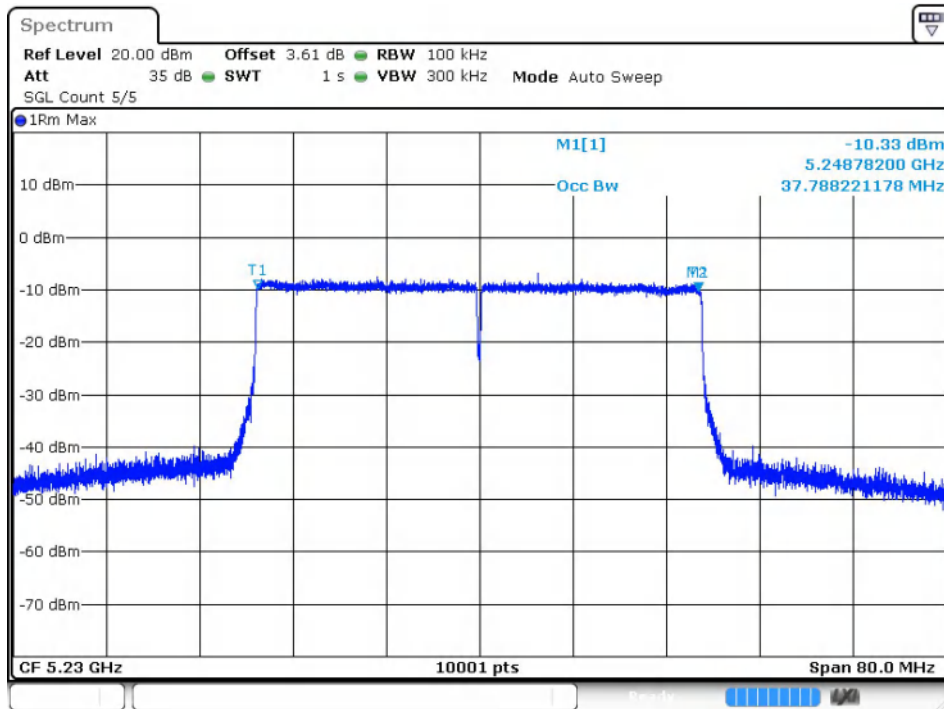
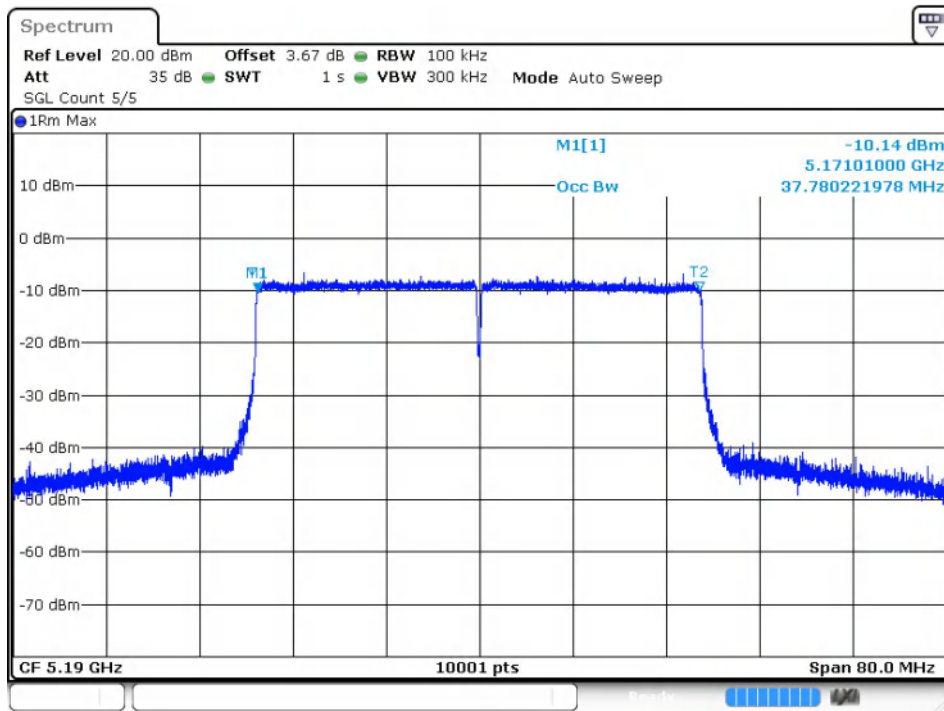

802.11ax80

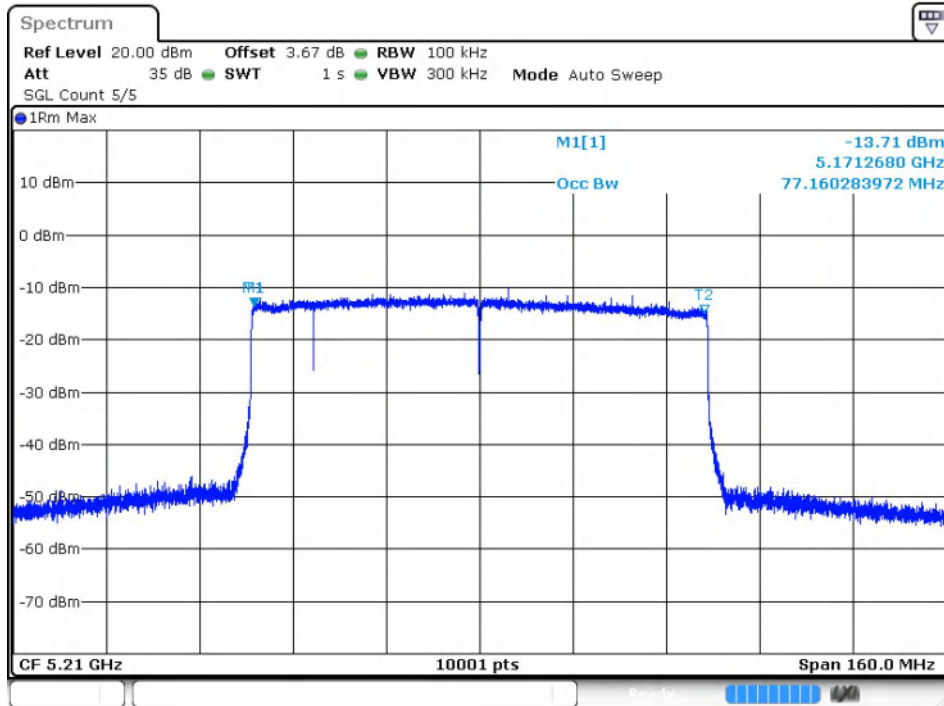

6.1.3 RF output power, Transmit Power Control (TPC) and Power Density

Test Requirement: EN 301 893 Clause 4.2.3

Test Method: EN 301 893 Clause 5.4.4

EUT Operation:

Ambient: Temp.: 25.0 °C Humid.: 56 % Press.: 1013 mbar

- Test Status:
- 1) Enter test mode (802.11a, 802.11n and 802.11ac) for the product, and report the datas of 802.11a, 802.11n20, 802.11ac20, 802.11ax20, 802.11n40, 802.11ac40, 802.11ax40, 802.11ac80 and 802.11ax80.
 - 2) Pretest all mode, and report the worst data.
 - 3) These measurements shall be performed under both normal and extreme test conditions.

Equipment Used: Refer to section 5 for details.

Test Setup :

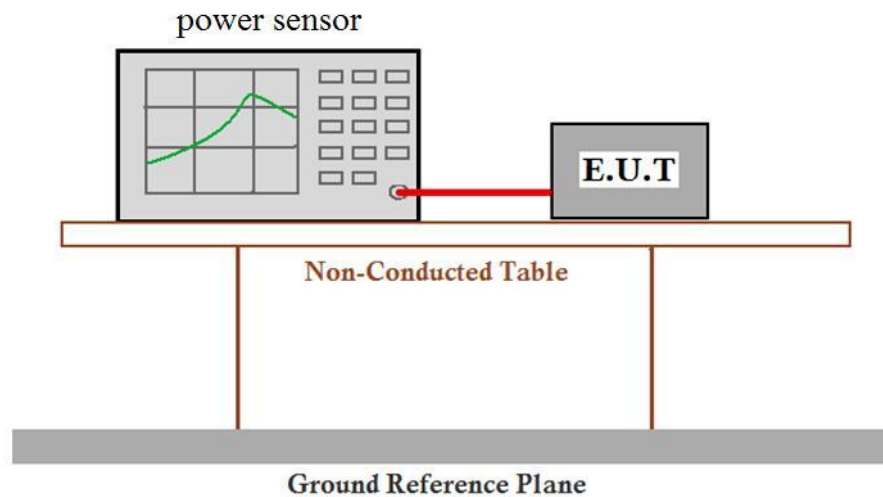

Limit:

E.I.R.P limits for RF output power and power density at the highest power level

Frequency range (MHz)	Mean e.i.r.p. limit [dBm]		Mean e.i.r.p. density limit [dBm/MHz]	
	With TPC	Without TPC	With TPC	Without TPC
5150 to 5350	23	20 / 23 (see note 1)	10	7 / 10 (see note 2)
5470 to 5725	30 (see note 3)	27 (see note 3)	17 (see note 3)	14 (see note 3)

Note 1: The applicable limit is 20 dBm, except for transmissions whose nominal bandwidth falls completely within the band 5150 MHz to 5250 MHz, in which case the applicable limit is 23 dBm.

Note 2: The applicable limit is 7 dBm/MHz except for transmissions whose nominal bandwidth falls completely within the band 5150 MHz to 5250 MHz, in which case the applicable limit is 10 dBm/MHz.

Note 3: Slave devices without a Radar Interference Detection function shall comply with the limits for the band 5250 MHz to 5350 MHz.

E.I.R.P limits for RF output power at the lowest power level

Frequency range (MHz)	Mean e.i.r.p. [dBm]
5250 to 5350	17
5470 to 5725	24 (see note)

Note: Slave devices without a Radar Interference Detection function shall comply with the limits for the band 5250 MHz to 5350 MHz.

Test Date:

Maximum Transmit Power e.i.r.p

IEEE 802.11a-20MHz Test Conditions	Average EIRP Power (dBm)		
	5180MHz	5200MHz	5240MHz
Temp (25)°C	16.66	16.46	16.33
Temp (0)°C	16.62	16.44	16.30
Temp (40)°C	16.63	16.42	16.29
Limits	23	23	23

IEEE 802.11n-20MHz Test Conditions	Average EIRP Power (dBm)		
	5180MHz	5200MHz	5240MHz
Temp (25)°C	16.05	15.87	15.44
Temp (0)°C	16.02	15.86	15.40
Temp (40)°C	16.03	15.84	15.42
Limits	23	23	23

IEEE 802.11n-40MHz Test Conditions	Average EIRP Power (dBm)	
	5190MHz	5230MHz
Temp (25)°C	15.79	15.49
Temp (0)°C	15.75	15.46
Temp (40)°C	15.78	15.44
Limits	23	23

IEEE 802.11ac-20MHz Test Conditions	Average EIRP Power (dBm)		
	5180MHz	5200MHz	5240MHz
Temp (25)°C	16.06	16.05	15.57
Temp (0)°C	16.02	16.03	15.54
Temp (40)°C	16.03	16.00	15.51
Limits	23	23	23

IEEE 802.11ac-40MHz Test Conditions	Average EIRP Power (dBm)	
	5190MHz	5230MHz
Temp (25)°C	15.60	15.54
Temp (0)°C	15.52	15.54
Temp (40)°C	15.59	15.51
Limits	23	23

IEEE 802.11ac-80MHz Test Conditions	Average EIRP Power (dBm)	
	5210MHz	--
Temp (25)°C	14.88	--
Temp (0)°C	14.85	--
Temp (40)°C	14.83	--
Limits	23	--

IEEE 802.11ax-20MHz Test Conditions	Average EIRP Power (dBm)		
	5180MHz	5200MHz	5240MHz
Temp (25)°C	16.23	15.93	15.64
Temp (0)°C	16.20	15.88	15.61
Temp (40)°C	16.18	15.90	15.62
Limits	23	23	23

IEEE 802.11ax-40MHz Test Conditions	Average EIRP Power (dBm)	
	5190MHz	5230MHz
Temp (25)°C	15.54	15.64
Temp (0)°C	15.52	15.59
Temp (40)°C	15.50	15.62
Limits	23	23

IEEE 802.11ax-80MHz Test Conditions	Average EIRP Power (dBm)	
	5210MHz	--
Temp (25)°C	14.53	--
Temp (0)°C	14.49	--
Temp (40)°C	14.52	--
Limits	23	--

Remark: e.i.r.p= read level(dBm) +cable loss+ Product antenna gain
 Pretest all mode, only report the worst data.

Power Density Test Data

Mode	Frequency (MHz)	Max PSD (dBm/MHz)	Limit (dBm/MHz)	Verdict
a	5180	2.12	10	Pass
a	5200	2	10	Pass
a	5240	1.88	10	Pass
n20	5180	1.43	10	Pass
n20	5200	1.3	10	Pass
n20	5240	0.77	10	Pass
n40	5190	-1.9	10	Pass
n40	5230	-1.83	10	Pass
ac20	5180	1.39	10	Pass
ac20	5200	1.56	10	Pass
ac20	5240	0.93	10	Pass
ac40	5190	-2.03	10	Pass
ac40	5230	-2	10	Pass
ac80	5210	-5.37	10	Pass
ax20	5180	1.05	10	Pass
ax20	5200	0.68	10	Pass
ax20	5240	0.28	10	Pass
ax40	5190	-2.67	10	Pass
ax40	5230	-2.28	10	Pass
ax80	5210	-6.19	10	Pass

6.1.4 Transmitter unwanted emissions outside the 5 GHz RLAN bands

Test Requirement: EN 301 893 Clause 4.2.4

Test Method: EN 301 893 Clause 5.4.5

EUT Operation:

Ambient: Temp.: 26.0 °C Humid.: 56 % Press.: 1012 mbar

- Test Status:
- 1) Enter test mode(802.11a, 802.11n and 802.11ac) for the product, and report the datas of 802.11a.
 - 2) Pretest all mode, and report the worst data.
 - 3) These measurements shall be verified only under normal operating conditions.

Equipment Used: Refer to section 5 for details.

Test Setup

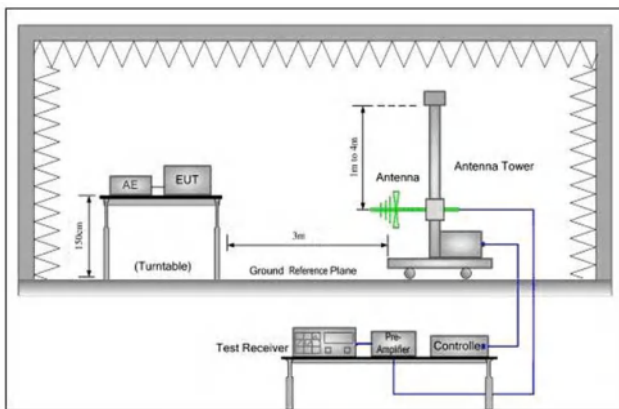

Figure 1. 30MHz to 1GHz

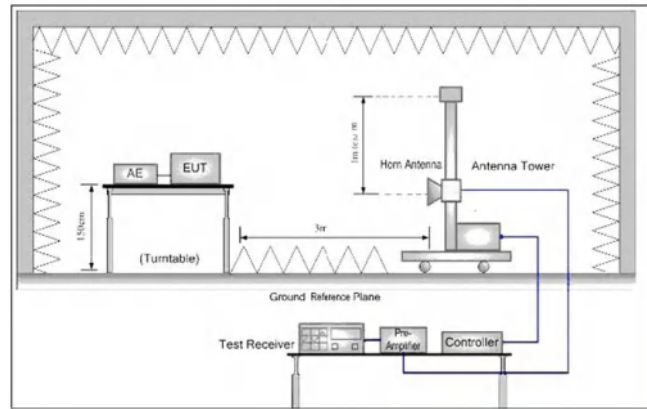

Figure 2. Above 1GHz

- Test Procedure:**
1. Scan from 30MHz to 26 GHz, find the maximum radiation frequency to measure.
 2. The technique used to find the Spurious Emissions of the transmitter was the antenna substitution method. Substitution method was performed to determine the actual ERP/EIRP emission levels of the EUT.

Below 1GHz test procedure as below:

- 1) The EUT was powered ON and placed on a 1.5m high table in the chamber. The antenna of the transmitter was extended to its maximum length. modulation mode and the measuring receiver shall be tuned to the frequency of the transmitter under test.
- 2) The disturbance of the transmitter was maximized on the test receiver display by raising and lowering from 1m to 4m the receive antenna and by rotating through 360° the turntable. After the fundamental emission was maximized, a field strength measurement was made.
- 3) Steps 1) and 2) were performed with the EUT and the receive antenna in both vertical and horizontal polarization.
- 4) The transmitter was then removed and replaced with another antenna. The center of the antenna was approximately at the same location as the center of

the transmitter.

- 5) A signal at the disturbance was fed to the substitution antenna by means of a non-radiating cable. With both the substitution and the receive antennas horizontally polarized, the receive antenna was raised and lowered to obtain a maximum reading at the test receiver. The level of the signal generator was adjusted until the measured field strength level in step 2) is obtained for this set of conditions.
- 6) The output power into the substitution antenna was then measured.
- 7) Steps 5) and 6) were repeated with both antennas polarized.
- 8) Calculate power in dBm by the following formula:

$$ERP(dBm) = P_g(dBm) - \text{cable loss (dB)} + \text{antenna gain (dBd)}$$

where:

P_g is the generator output power into the substitution antenna.

Above 1GHz test procedure as below:

- 1) Different between above is the test site, change from Semi- Anechoic Chamber to fully Anechoic Chamber and receiving antenna is moved from 1m to 2m.
- 2) Calculate power in dBm by the following formula:

$$EIRP(dBm) = P_g(dBm) - \text{cable loss (dB)} + \text{antenna gain (dBi)}$$

$$EIRP = ERP + 2.15dB$$

where:

P_g is the generator output power into the substitution antenna.

Standby mode test procedure as below:

- 1) Below 1GHz test procedure Steps 1) to 8) and Above 1GHz test procedure 1) to 2) shall be repeated with the transmitter in the standby condition if this option is available.

Limit:

Table 1: Transmitter limits for spurious emissions

Frequency range	Maximum power	Bandwidth
30 MHz to 47 MHz	-36 dBm	100 kHz
47 MHz to 74 MHz	-54 dBm	100 kHz
74 MHz to 87,5 MHz	-36 dBm	100 kHz
87,5 MHz to 118 MHz	-54 dBm	100 kHz
118 MHz to 174 MHz	-36 dBm	100 kHz
174 MHz to 230 MHz	-54 dBm	100 kHz
230 MHz to 470 MHz	-36 dBm	100 kHz
470 MHz to 862 MHz	-54 dBm	100 kHz
862 MHz to 1 GHz	-36 dBm	100 kHz
1 GHz to 5,15 GHz	-30 dBm	1 MHz
5,35 GHz to 5,47 GHz	-30 dBm	1 MHz
5,725 GHz to 26 GHz	-30 dBm	1 MHz

Test Data:

Transmitting with modulation Mode at 5180MHz for 802.11a				
Frequency	Spurious Emission Level		Limit	Over limit
(MHz)	Polaxis	(dBm)	dBm	(dB)
38.2870	Vertical	-68.95	-36.00	-32.95
213.4751	Vertical	-67.86	-54.00	-13.86
748.1679	Vertical	-60.32	-36.00	-24.32
96.9646	Horizontal	-62.98	-54.00	-8.98
344.2670	Horizontal	-64.08	-36.00	-28.08
523.9891	Horizontal	-65.79	-54.00	-11.79

Transmitting with modulation Mode at 5240MHz for 802.11a				
Frequency	Spurious Emission Level		Limit	Over limit
(MHz)	Polaxis	(dBm)	dBm	(dB)
36.2435	Vertical	-69.21	-36.00	-33.21
153.0902	Vertical	-69.87	-36.00	-33.87
405.3985	Vertical	-67.18	-36.00	-31.18
108.8213	Horizontal	-61.50	-54.00	-7.50
316.8589	Horizontal	-65.00	-36.00	-29.00
751.3155	Horizontal	-61.25	-36.00	-25.25

Transmitting with modulation Mode at 5180MHz for 802.11a				
Frequency	Spurious Emission Level		Limit	Over limit
(MHz)	Polaxis	(dBm)	dBm	(dB)
1421.532	Vertical	-45.81	-30.00	-15.81
2996.906	Vertical	-43.94	-30.00	-13.94
5008.561	Vertical	-44.75	-30.00	-14.75
2200.195	Horizontal	-40.92	-30.00	-10.92
2927.982	Horizontal	-44.28	-30.00	-14.28
4810.365	Horizontal	-48.71	-30.00	-18.71

Transmitting with modulation Mode at 5240MHz for 802.11a				
Frequency	Spurious Emission Level		Limit	Over limit
(MHz)	Polaxis	(dBm)	dBm	(dB)
1643.633	Vertical	-45.71	-30.00	-15.71
2897.288	Vertical	-44.80	-30.00	-14.80
4835.540	Vertical	-45.79	-30.00	-15.79
1670.906	Horizontal	-45.93	-30.00	-15.93
3230.503	Horizontal	-44.63	-30.00	-14.63
4835.079	Horizontal	-43.98	-30.00	-13.98

Transmitting with modulation Mode at 5180MHz for 802.11n20				
Frequency (MHz)	Spurious Emission Level		Limit dBm	Over limit (dB)
	Polaxis	(dBm)		
1465.411	Vertical	-45.59	-30.00	-15.59
3292.682	Vertical	-42.46	-30.00	-12.46
5169.315	Vertical	-41.53	-30.00	-11.53
2497.515	Horizontal	-39.43	-30.00	-9.43
2716.376	Horizontal	-45.34	-30.00	-15.34
4952.616	Horizontal	-45.87	-30.00	-15.87

Transmitting with modulation Mode at 5240MHz for 802.11n20				
Frequency (MHz)	Spurious Emission Level		Limit dBm	Over limit (dB)
	Polaxis	(dBm)		
1502.066	Vertical	-45.41	-30.00	-15.41
3240.921	Vertical	-42.72	-30.00	-12.72
5147.269	Vertical	-41.97	-30.00	-11.97
1835.417	Horizontal	-47.74	-30.00	-17.74
2905.806	Horizontal	-44.39	-30.00	-14.39
4983.700	Horizontal	-45.25	-30.00	-15.25

Transmitting with modulation Mode at 5210MHz for 802.11ac80				
Frequency (MHz)	Spurious Emission Level		Limit dBm	Over limit (dB)
	Polaxis	(dBm)		
1192.966	Vertical	-41.96	-30.00	-11.96
2820.681	Vertical	-44.82	-30.00	-14.82
4802.923	Vertical	-48.86	-30.00	-18.86
1243.692	Horizontal	-45.70	-30.00	-15.70
2657.878	Horizontal	-45.63	-30.00	-15.63
5141.069	Horizontal	-42.10	-30.00	-12.10

Remark:

1. The disturbance below 1GHz was very low, and the above harmonics were the highest point could be found when testing, so only the above harmonics had been displayed.
2. The disturbance above 18GHz was very low, and the above harmonics were the highest point could be found when testing, so only the above harmonics had been displayed.

6.1.5 Transmitter unwanted emissions within the 5 GHz RLAN bands

Test Requirement: EN 301 893 Clause 4.2.4.2

Test Method: EN 301 893 Clause 5.4.6

EUT Operation:

- Ambient: Temp.: 25.0 °C Humid.: 52 % Press.: 1012 mbar
- Test Status: 1) Enter test mode(802.11a, 802.11n, 802.11ac and 802.11ax) for the product. And report the worst case mode.
 2) Pretest all mode, and report the worst data.
 3) These measurements shall be verified only under normal operating conditions.

Equipment Used: Refer to section 5 for details.

Test Setup

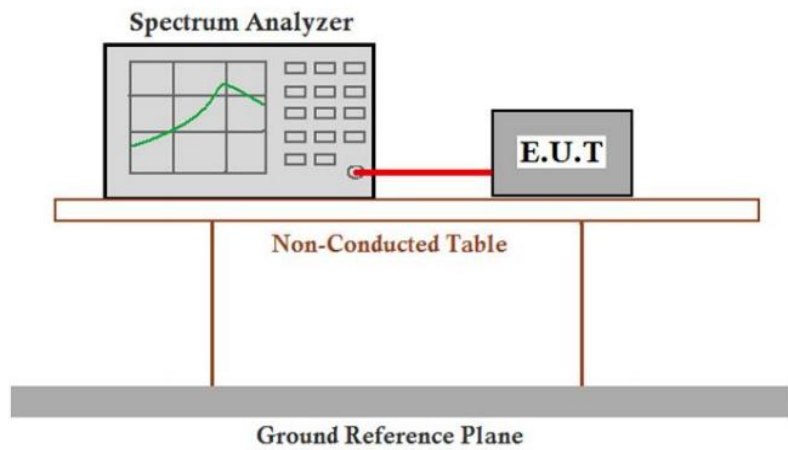

Limit:

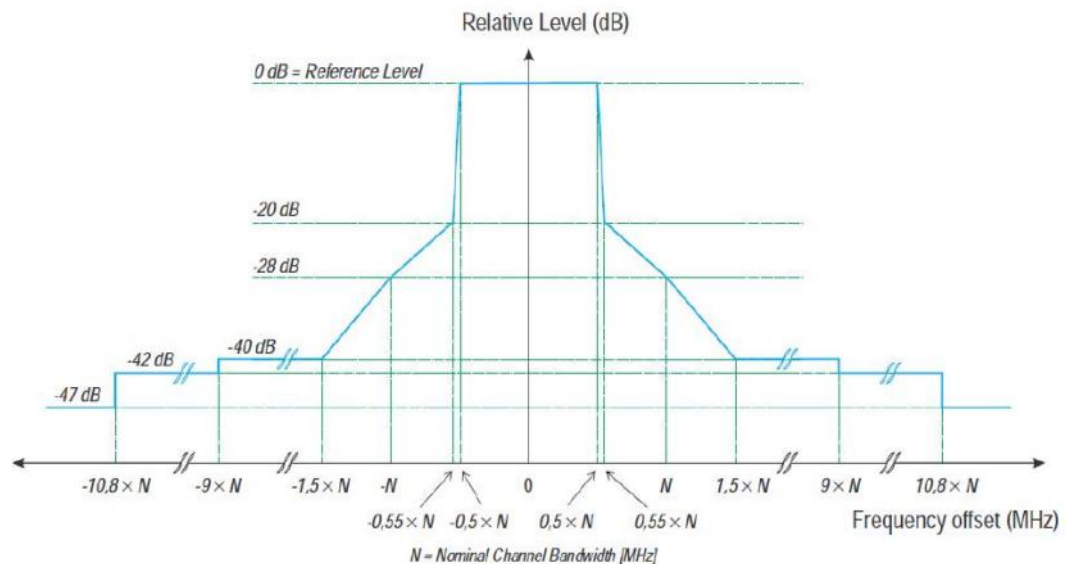

Figure 1: Transmit spectral power mask

Test Data:

Test Result of Transmitter Unwanted Emissions within the 5 GHz RLAN bands.(list the worst case of each mode)

For 802.11a

5180MHz

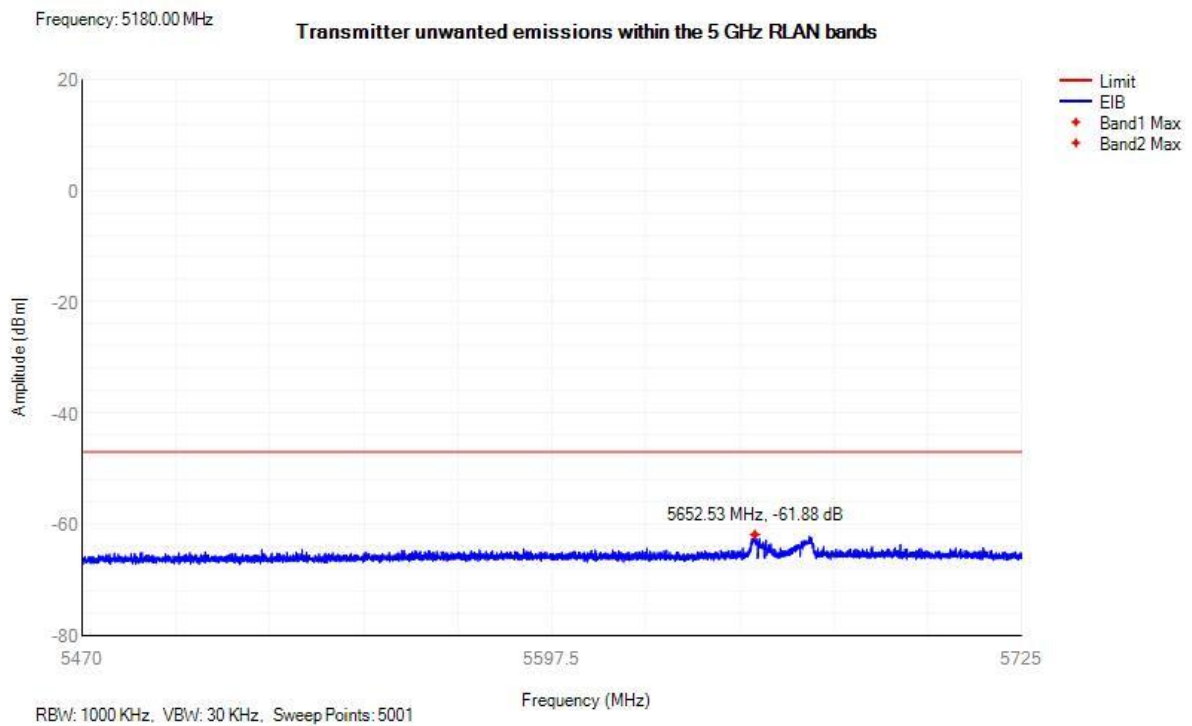
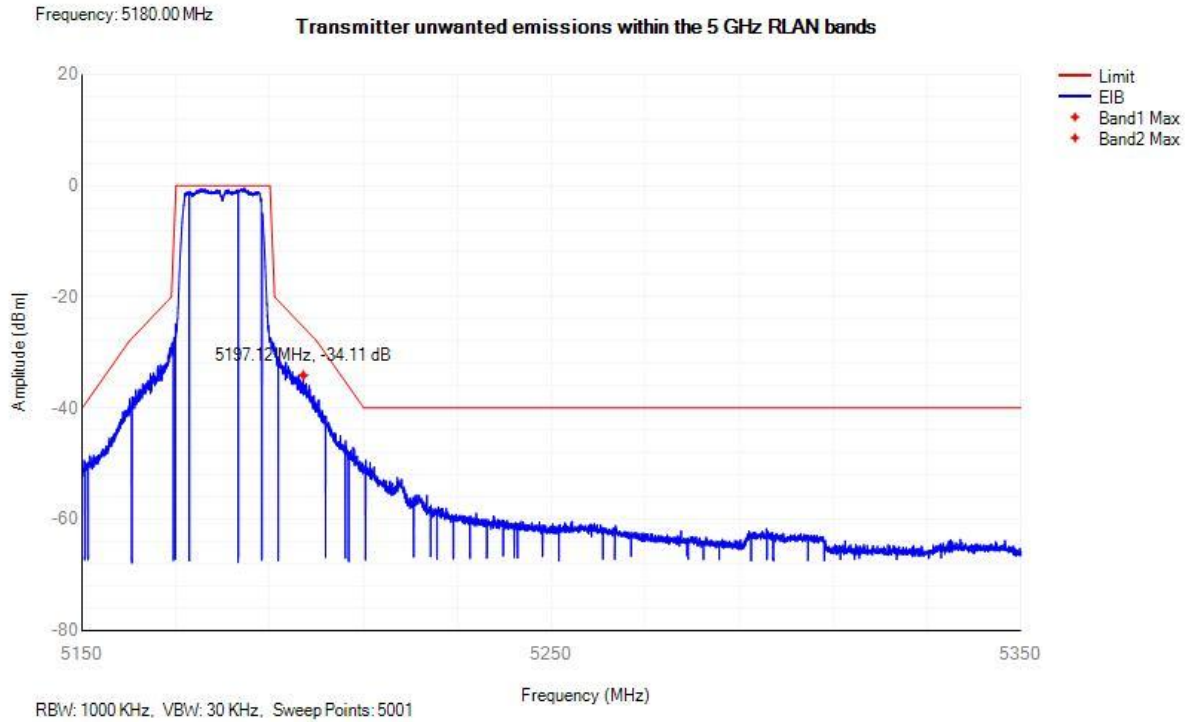

For 802.11n-HT20

5180MHz

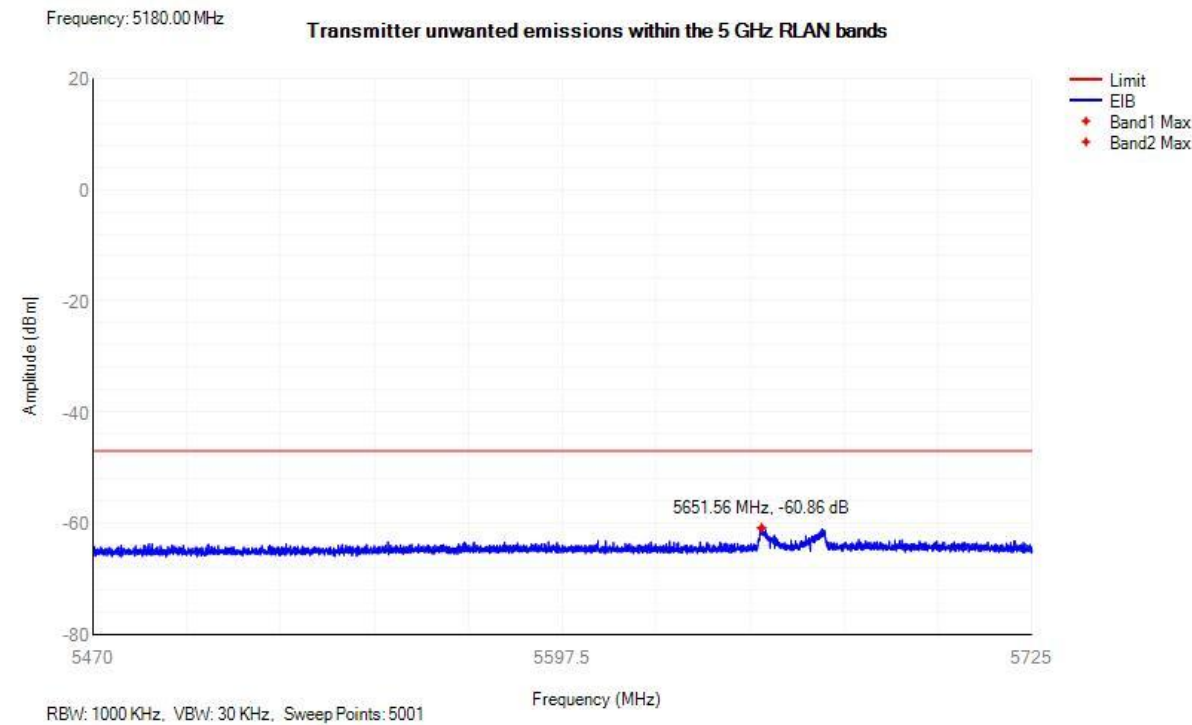
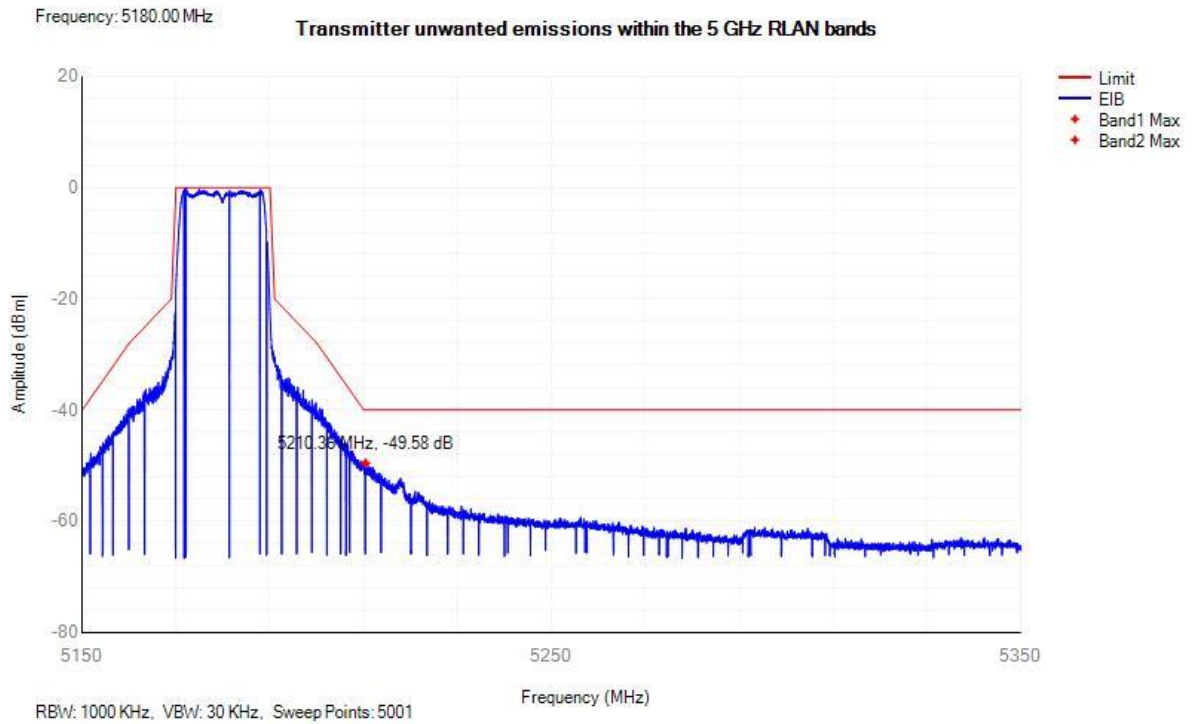

For 802.11n-HT40

5190MHz

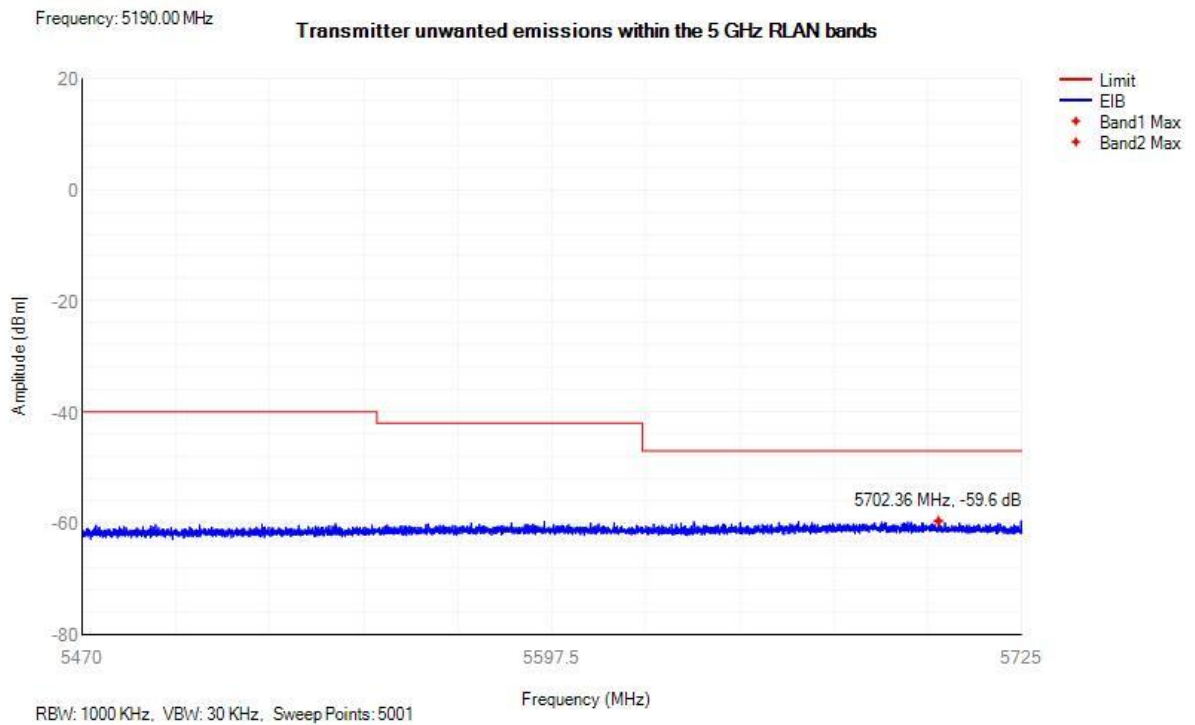
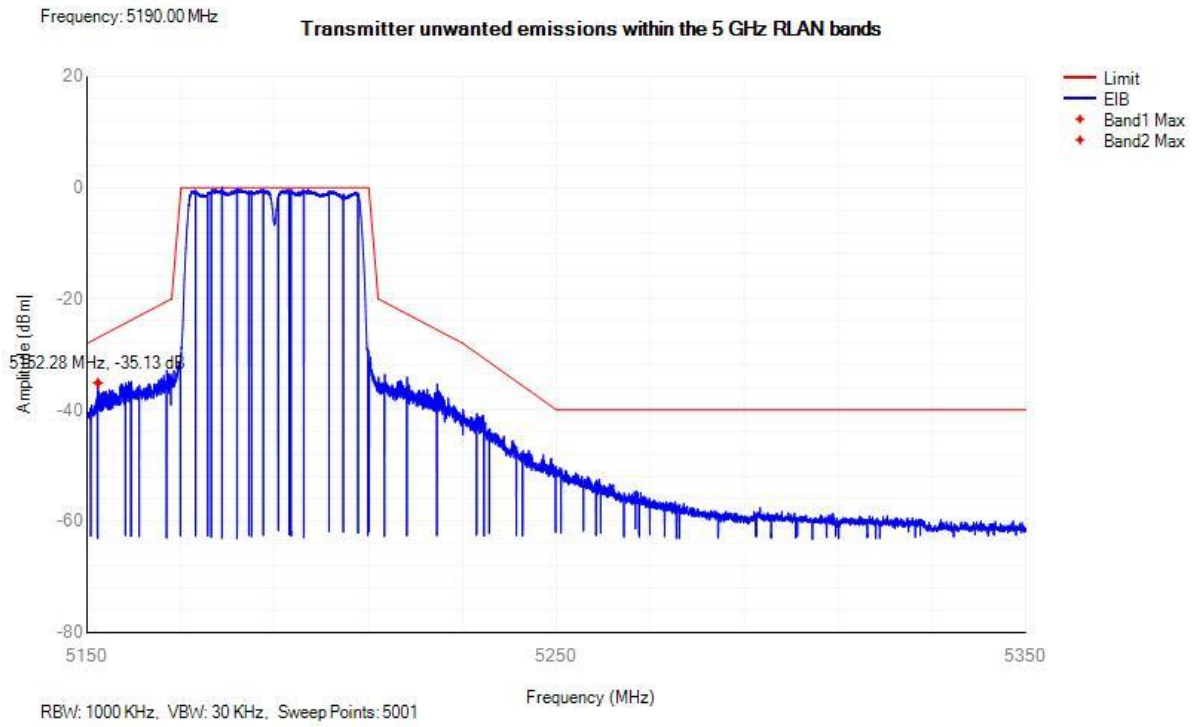

For 802.11ac-VHT80

5210MHz

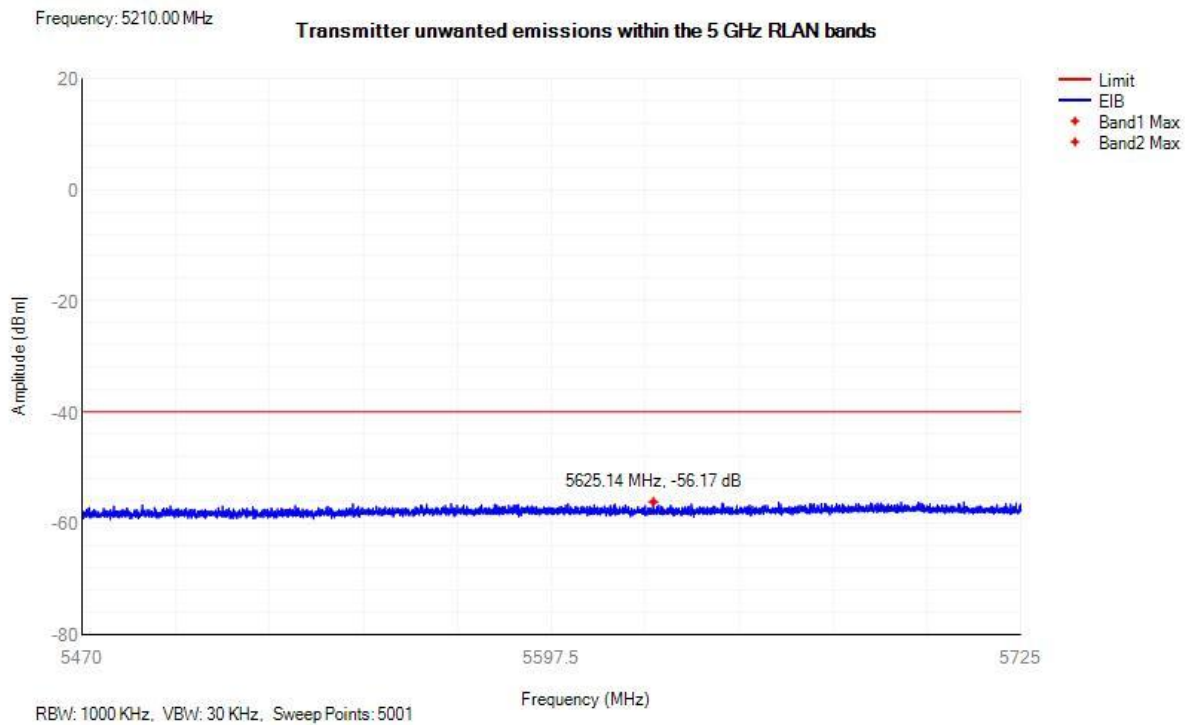
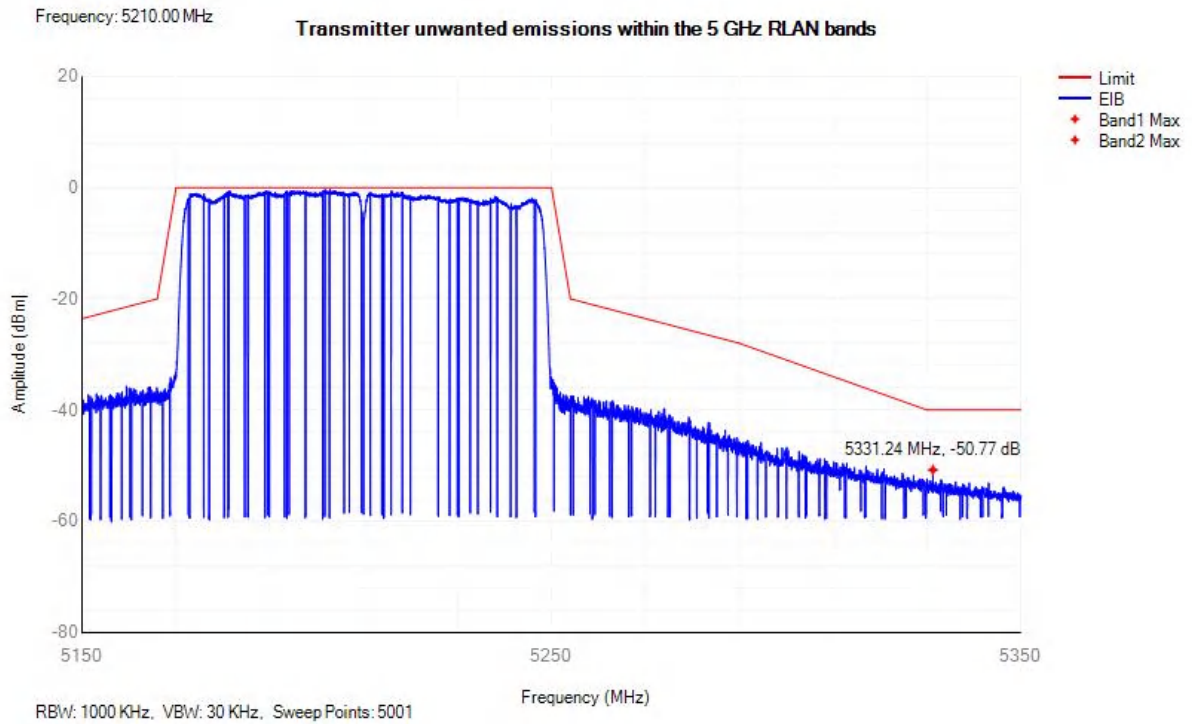

6.1.6 Receiver spurious emissions

Test Requirement: EN 300 893 Clause 4.2.5

Test Method: EN 300 893 Clause 5.4.7

EUT Operation:

Ambient: Temp.: 26.0 °C Humid.: 52 % Press.: 1010 mbar

- Test Status:
- 1) Enter test mode (802.11a, 802.11n20, 802.11n40 and 802.11ac) for the product. Find the worst case in **802.11ac80** mode.
 - 2) Pretest all mode, and report the worst data.
 - 3) Testing shall be performed when the equipment is in a receive-only mode.
 - 4) Test EUT in normal conditions.

Equipment Used: Refer to section 5 for details.

Test Setup:

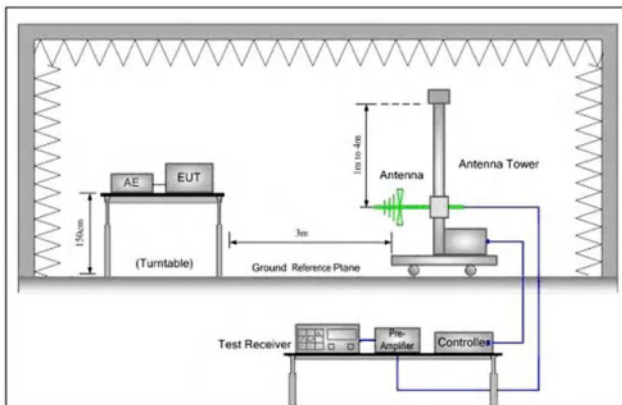
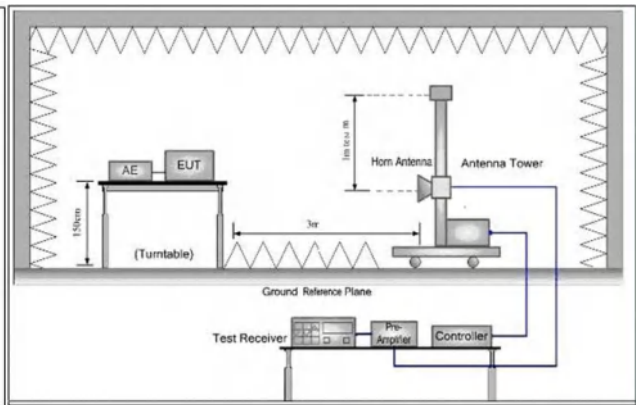

Figure 1. 30MHz to 1GHz



Figure

2. Above 1GHz

Test Procedure:

1. Scan from 30MHz to 26GHz, find the maximum radiation frequency to measure.
2. The technique used to find the Spurious Emissions of the transmitter was the antenna substitution method. Substitution method was performed to determine the actual ERP/EIRP emission levels of the EUT.

Below 1GHz test procedure as below:

- 1) The EUT was powered ON and placed on a 1.5m high table in the chamber. The antenna of the transmitter was extended to its maximum length. Receiver mode and the measuring receiver shall be tuned to the frequency of the transmitter under test.
- 2) The disturbance of the transmitter was maximized on the test receiver display by raising and lowering from 1m to 4m the receive antenna and by rotating through 360° the turntable. After the fundamental emission was maximized, a field strength measurement was made.
- 3) Steps 1) and 2) were performed with the EUT and the receive antenna in both vertical and horizontal polarization.

- 4) The transmitter was then removed and replaced with another antenna. The center of the antenna was approximately at the same location as the center of the transmitter.
- 5) A signal at the disturbance was fed to the substitution antenna by means of a non-radiating cable. With both the substitution and the receive antennas horizontally polarized, the receive antenna was raised and lowered to obtain a maximum reading at the test receiver. The level of the signal generator was adjusted until the measured field strength level in step 2) is obtained for this set of conditions.
- 6) The output power into the substitution antenna was then measured.
- 7) Steps 5) and 6) were repeated with both antennas polarized.
- 8) Calculate power in dBm by the following formula:

$$ERP(dBm) = Pg(dBm) - \text{cable loss (dB)} + \text{antenna gain (dBd)}$$

where:

Pg is the generator output power into the substitution antenna.

Above 1GHz test procedure as below:

- 1) Different between above is the test site, change from Semi- Anechoic Chamber to fully Anechoic Chamber and receiving antenna is moved from 1m to 2m.
- 2) Calculate power in dBm by the following formula:

$$EIRP(dBm) = Pg(dBm) - \text{cable loss (dB)} + \text{antenna gain (dBi)}$$

$$EIRP=ERP+2.15dB$$

where:

Pg is the generator output power into the substitution antenna.

Limit:

Table 2: Spurious emission limits for receivers

Frequency range	Maximum power	bandwidth
	e.r.p. (≤ 1 GHz) e.i.r.p. (> 1 GHz)	
30 MHz to 1 GHz	-57 dBm	100 kHz
1 GHz to 26 GHz	-47 dBm	1MHz

Test Data:

Receiving mode at 802.11ac80				
Frequency	Spurious Emission Level		Limit	Over limit
(MHz)	Polaxis	(dBm)	dBm	(dB)
70.244	Vertical	-71.69	-57.00	-14.69
136.342	Vertical	-70.07	-57.00	-13.07
559.495	Vertical	-68.14	-57.00	-11.14
58.402	Horizontal	-73.56	-57.00	-16.56
403.781	Horizontal	-70.88	-57.00	-13.88
424.484	Horizontal	-64.76	-57.00	-7.76

Receiving mode at 802.11 ac80				
Frequency	Spurious Emission Level		Limit	Over limit
(MHz)	Polaxis	(dBm)	dBm	(dB)
1210.912	Vertical	-59.87	-47.00	-12.87
3033.518	Vertical	-55.58	-47.00	-8.58
5170.076	Vertical	-52.52	-47.00	-5.52
1382.534	Horizontal	-58.01	-47.00	-11.01
2660.951	Horizontal	-59.31	-47.00	-12.31
4817.334	Horizontal	-59.57	-47.00	-12.57

Remark:

1.The disturbance above 18GHz was very low, and the above harmonics were the highest point could be found when testing, so only the above harmonics had been displayed.

6.1.7 Adaptivity (Channel Access Mechanism)

Definition: Adaptivity (Channel Access Mechanism) is an automatic mechanism by which a device limits its transmissions and gains access to an Operating Channel. Adaptivity is not intended to be used as an alternative to DFS to detect radar transmissions, but to detect transmissions from other RLAN devices operating in the band. DFS requirements are covered by clause 4.2.6.

Test Requirement: EN 300 893 Clause 4.2.7

For Frame Based Equipment(LBE):

The ED Threshold Level (TL):

The $PH \leq 13 \text{ dBm}$: $TL = -75 \text{ dBm/MHz}$

For $13 \text{ dBm} < PH < 23 \text{ dBm}$: $TL = -85 \text{ dBm/MHz} + (23 \text{ dBm} - PH)$

The $PH \geq 23 \text{ dBm}$: $TL = -85 \text{ dBm/MHz}$

For Frame Based Equipment (FBE)

For equipment that for its operation in the 5 GHz bands is conforming to IEEE 802.11™-2016 [9], clause 17, clause 19 or clause 21, or any combination of these clauses, the ED Threshold Level (TL) shall be: $TL = -75 \text{ dBm/MHz}$

For equipment conforming to one or more of the clauses listed in Option 1, and to at least one other operating mode, and for equipment conforming to none of the clauses listed in Option 1, the ED Threshold Level (TL) shall be proportional to the equipment's maximum transmit power (PH).

Assuming a 0 dBi receive antenna the ED Threshold Level (TL) shall be:

For $PH \leq 13 \text{ dBm}$: $TL = -75 \text{ dBm/MHz}$

For $13 \text{ dBm} < PH < 23 \text{ dBm}$: $TL = -85 \text{ dBm/MHz} + (23 \text{ dBm} - PH) \text{ (3)}$

For $PH \geq 23 \text{ dBm}$: $TL = -85 \text{ dBm/MHz}$

Test Method: EN 300 893 Clause 5.4.9

Limit: Frame Based Equipment(FBE) please refer to ETSI EN 301 893(V2.1.1) clause 4.2.73.1

Load Based Equipment(LBE) please refer to ETSI EN 301 893(V2.1.1) clause 4.2.73.2

EUT Operation:

Ambient: Temp.: 25.0 °C Humid.: 56 % Press.: 1013 mbar

Test configuration:

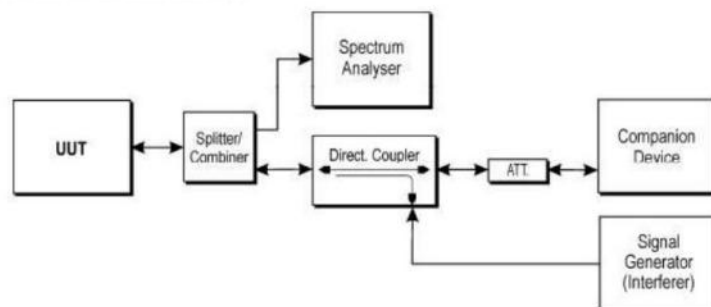
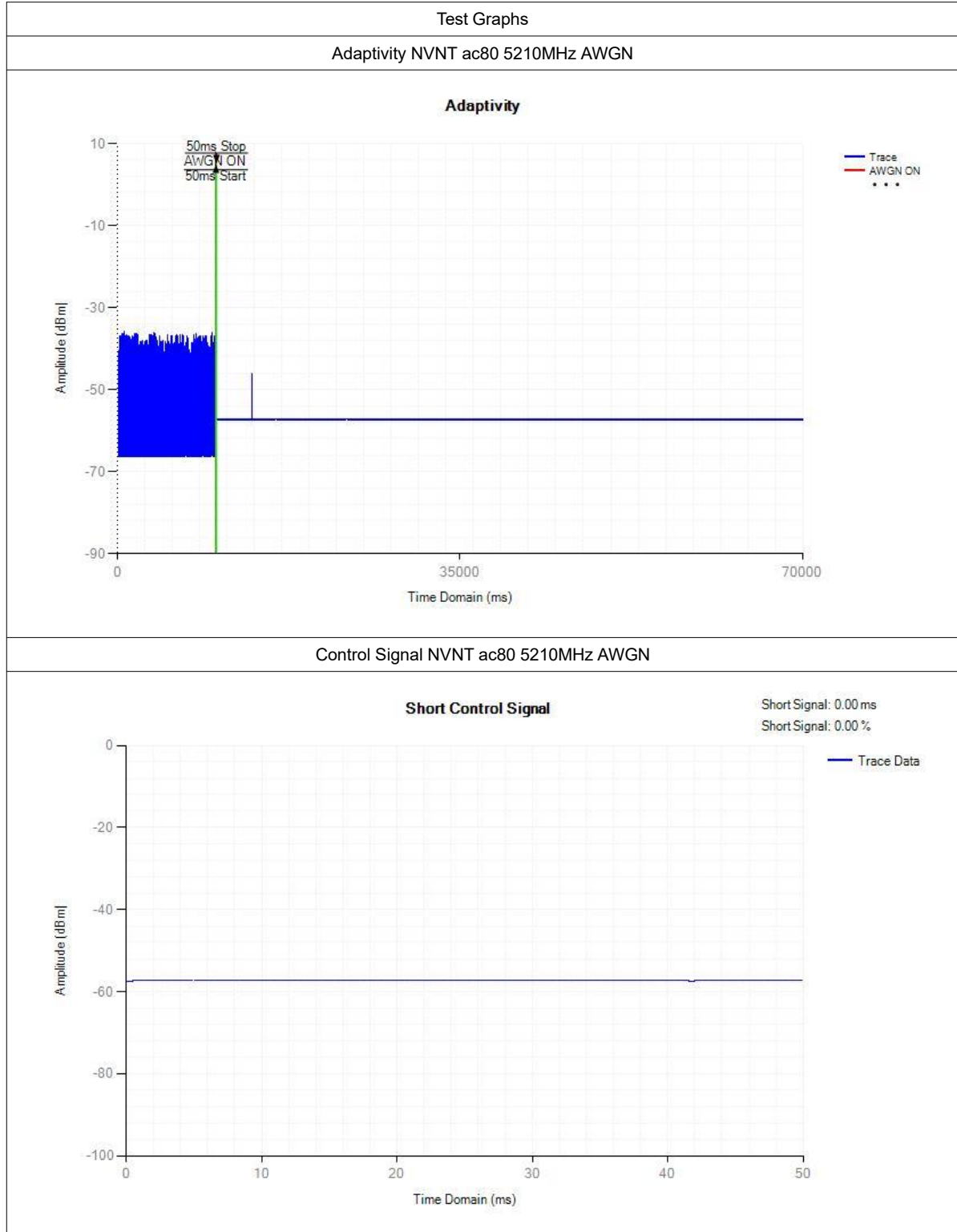
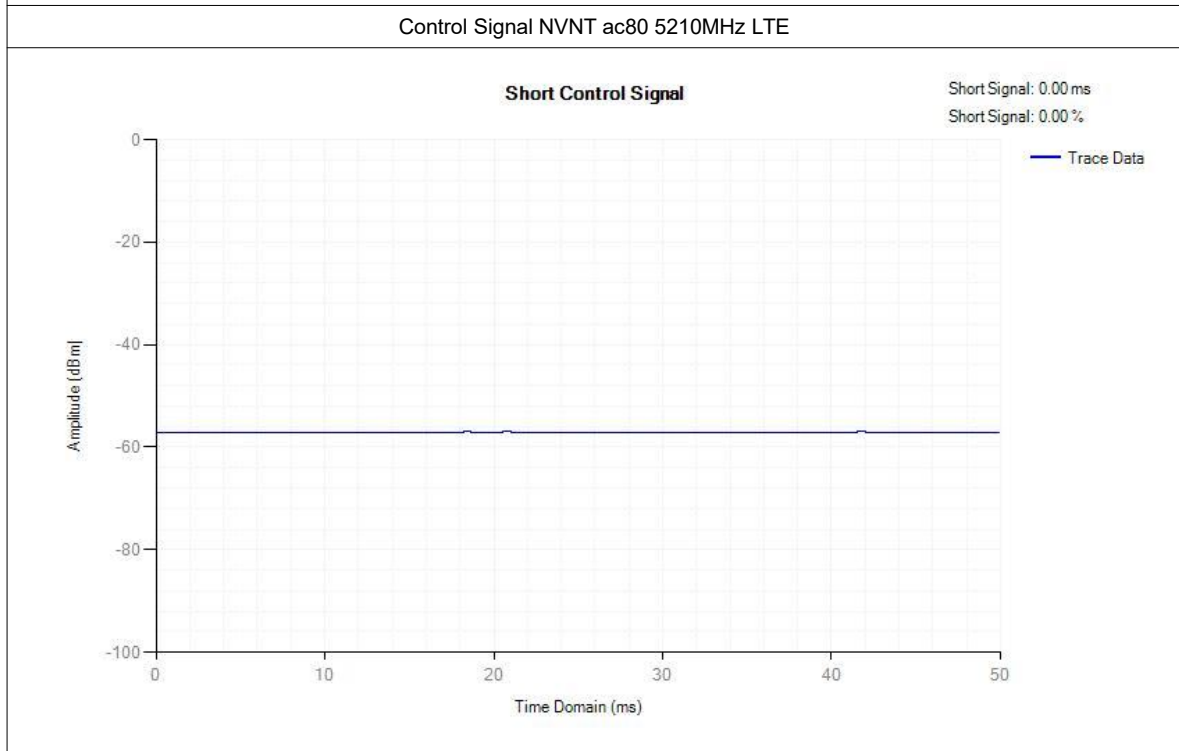
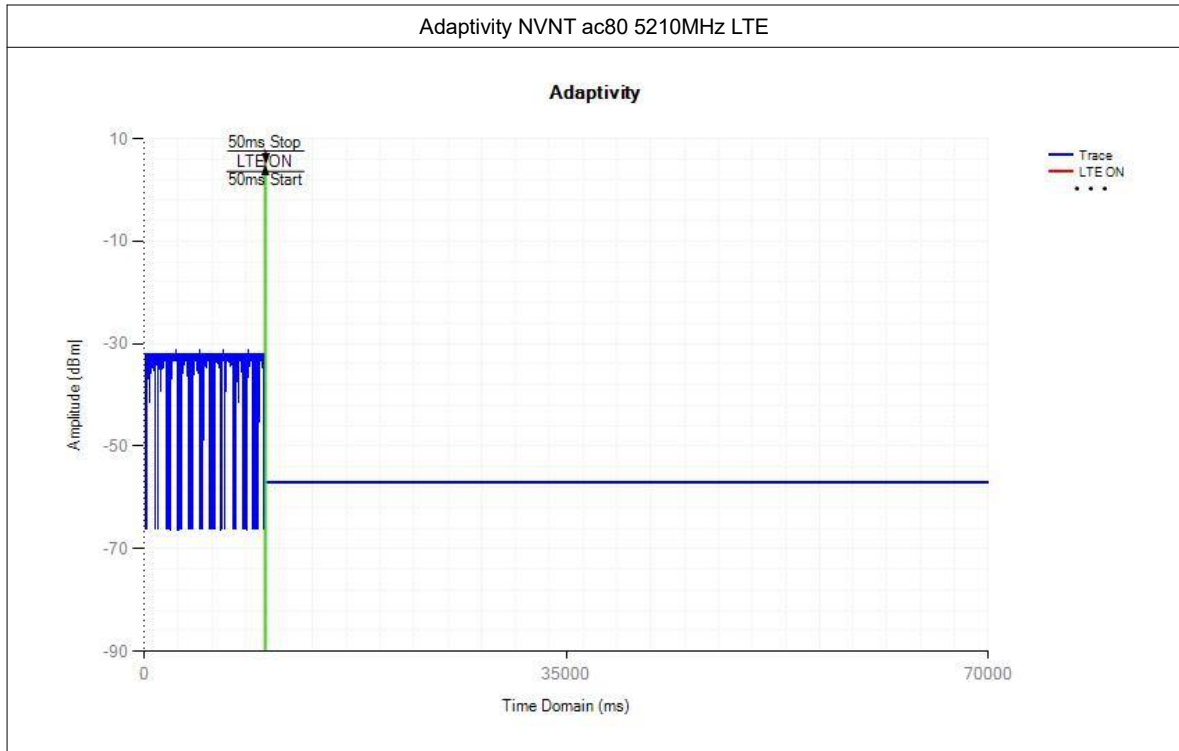
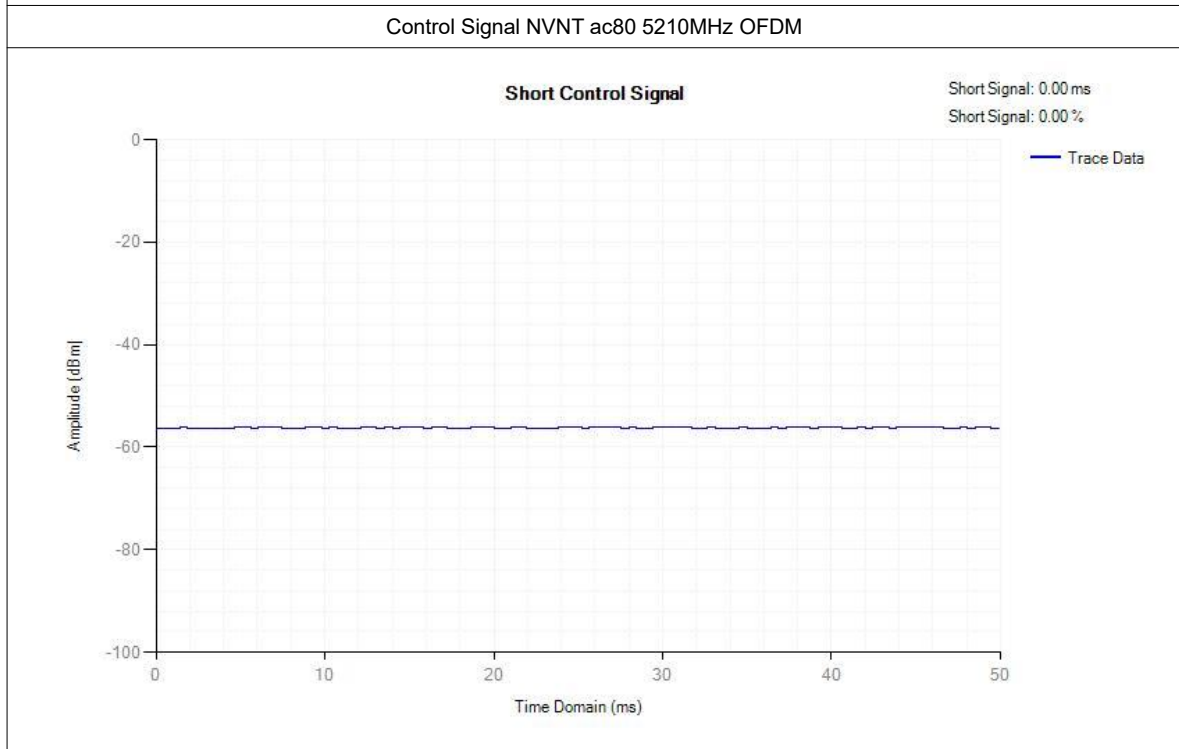
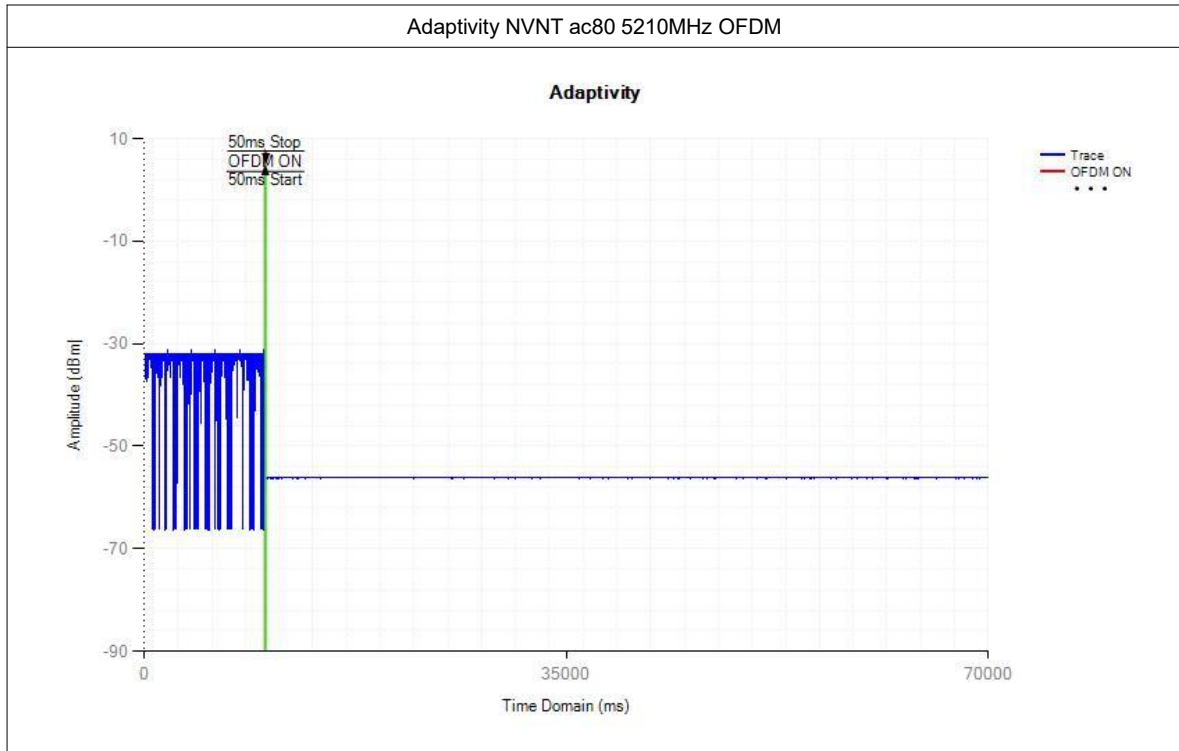

Figure 13: Example Test Set-up for verifying the adaptivity of an equipment

Mode	Frequency (MHz)	Interfer Type	Interfer Level (dBm)	Short Control (ms)	Limit (ms)	Short Control (n)	Limit (n)	Verdict
ac80	5210	AWGN	-75	0	<=2.5	0	<=50	Pass
ac80	5210	LTE	-75	0	<=2.5	0	<=50	Pass
ac80	5210	OFDM	-75	0	<=2.5	0	<=50	Pass







Mode	Frequency (MHz)	Priority Class	Max COT (ms)	Limit COT (ms)	Min Idle Time (ms)	Limit Idle Time (ms)	Verdict
ac80	5210	1	2.127	<=6	0.035	>0.027	Pass

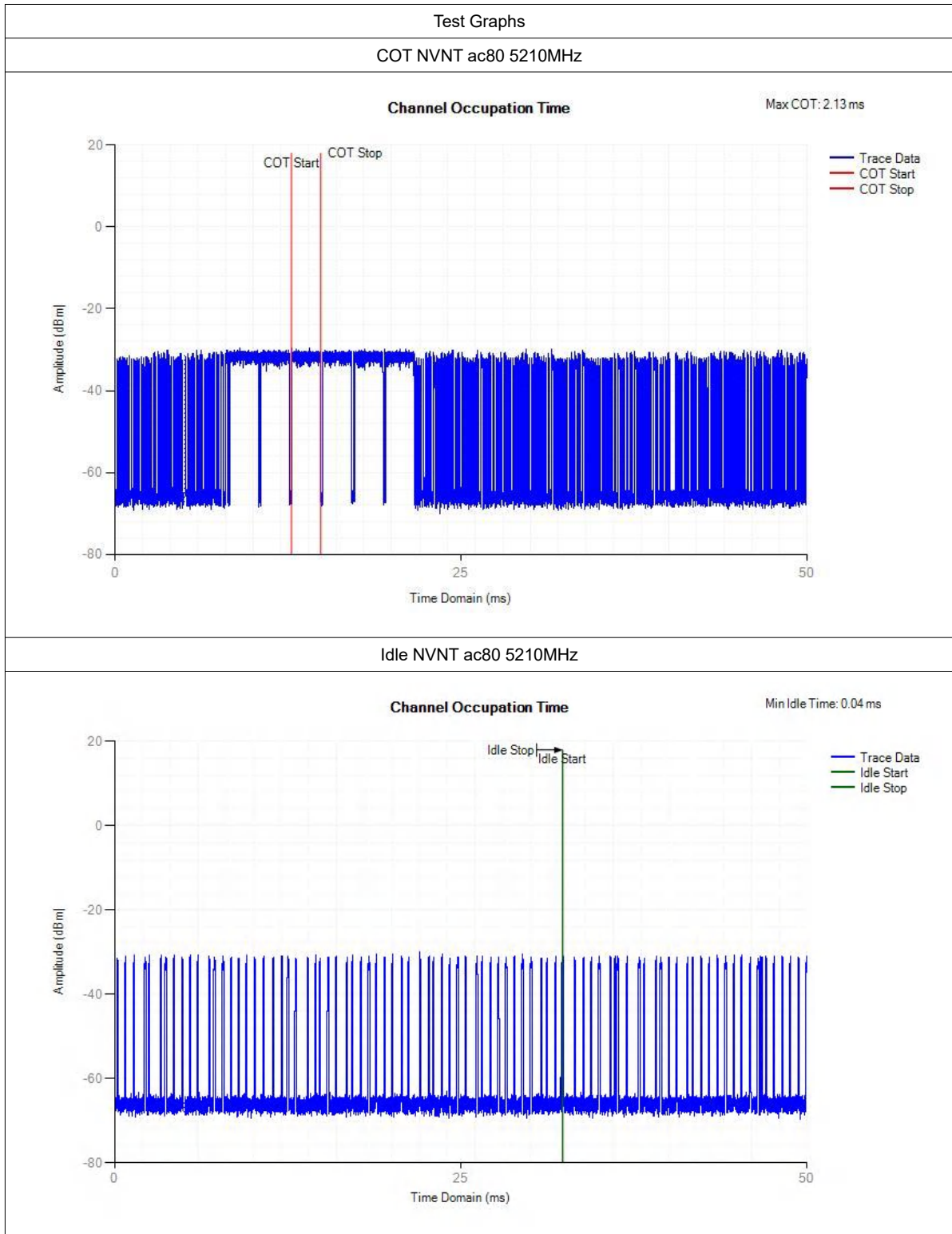

Mode	Frequency (MHz)	Priority Class	Bn	H(Bn)	Pn (%)	Limit (%)	Verdict
ac80	5210	1	0	106	1.05	5	Pass
ac80	5210	1	1	584	6.85	12	Pass
ac80	5210	1	2	727	14.06	18.25	Pass
ac80	5210	1	3	766	21.66	24.5	Pass
ac80	5210	1	4	700	28.61	30.75	Pass
ac80	5210	1	5	163	30.22	37	Pass
ac80	5210	1	6	158	31.79	43.25	Pass
ac80	5210	1	7	182	33.6	49.5	Pass
ac80	5210	1	8	169	35.27	55.75	Pass
ac80	5210	1	9	159	36.85	62	Pass
ac80	5210	1	10	13	36.98	68.25	Pass
ac80	5210	1	11	12	37.1	74.5	Pass
ac80	5210	1	12	19	37.29	80.75	Pass
ac80	5210	1	13	18	37.47	87	Pass
ac80	5210	1	14	29	37.76	93.25	Pass
ac80	5210	1	15	32	38.07	99.5	Pass
ac80	5210	1	16	6241	100	100	Pass

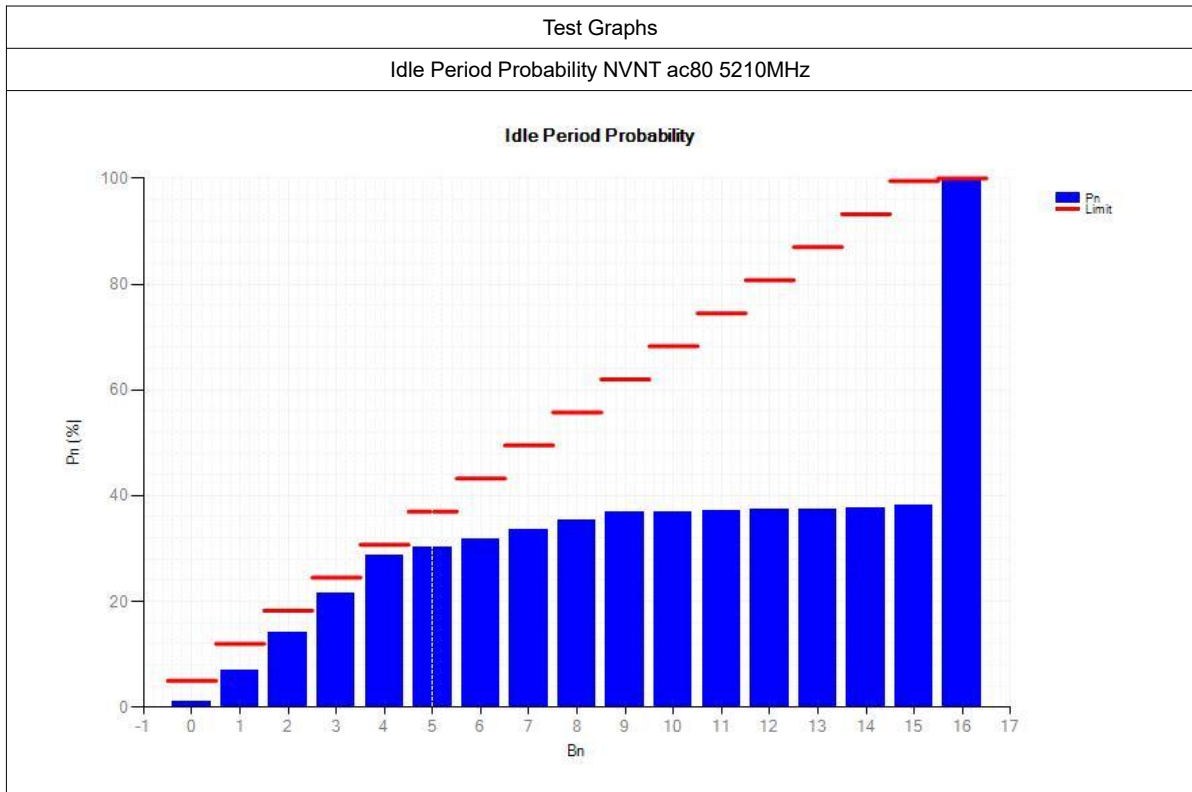

6.1.8 Receiver Blocking

Test Requirement: EN 300 893 Clause 4.2.8

Test Method: EN 300 893 Clause 5.4.10

Limit: While maintaining the minimum performance criteria as defined in clause 4.2.8.3, the blocking levels at specified frequency offsets shall be equal to or greater than the limits defined in table 9.

Table 9: Receiver Blocking parameters

Wanted signal mean power from companion device (dBm)	Blocking signal frequency (MHz)	Blocking signal power (dBm) (see note 2)		Type of blocking signal
		Master or Slave with radar detection (see table D.2, note 2)	Slave without radar detection (see table D.2, note 2)	
P _{min} + 6 dB	5 100	-53	-59	Continuous Wave
P _{min} + 6 dB	4 900 5 000 5 975	-47	-53	Continuous Wave

NOTE 1: P_{min} is the minimum level of the wanted signal (in dBm) required to meet the minimum performance criteria as defined clause 4.2.8.3 in the absence of any blocking signal.
 NOTE 2: The levels specified are levels in front of the UUT antenna. In case of conducted measurements, the same levels should be used at the antenna connector irrespective of antenna gain.

EUT Operation:

Ambient: Temp.: 25.0 °C Humid.: 56 % Press.: 1013 mbar

Test configuration: According to the section 5.4.10.2.1, the test block diagram shall be used.

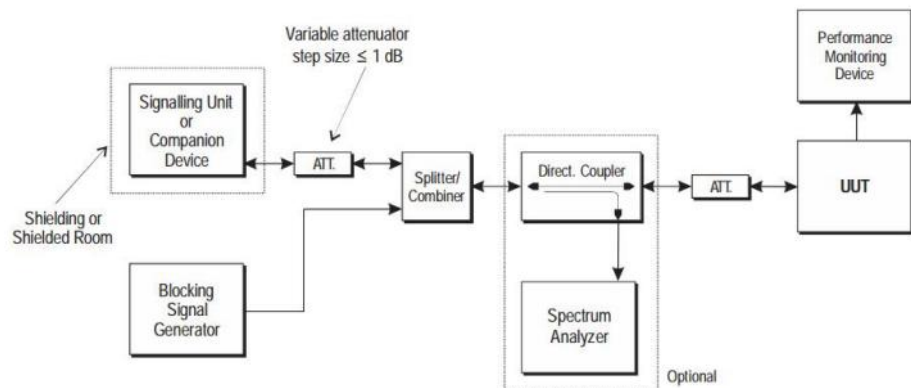

Figure 18: Test Set-up for receiver blocking

All test procedure is carried to the section 5.4.10.2.1

RBW/VBW=8MHz/28MHz

Test Mode: Receiving in 802.11a mode

Test Result: Compliant

Channel	Pmin (dBm)	Wanted signal Power from companion device (dBm)	Blocking signal Frequency (MHz)	Blocking signal Power (dBm)	PER (%)	Limit (%)
Low	-80	-74	5100	-59(See Note2)	2.4	≤10.00
			4900	-53 (See Note2)	2.4	≤10.00
			5000		2.7	≤10.00
			5975		2.2	≤10.00
High	-80	-74	5100	-59(See Note2)	3.1	≤10.00
			4900	-53 (See Note2)	2.3	≤10.00
			5000		2.5	≤10.00
			5975		2.5	≤10.00

Note1: PER monitored by software.

Test Mode: Receiving in 802.11n HT20 mode.

Test Result: Compliant

Channel	Pmin (dBm)	Wanted signal Power from companion device (dBm)	Blocking signal Frequency (MHz)	Blocking signal Power (dBm)	PER (%)	Limit (%)
Low	-80	-74	5100	-59(See Note2)	2.7	≤10.00
			4900	-53 (See Note2)	2.8	≤10.00
			5000		2.3	≤10.00
			5975		2.7	≤10.00
High	-80	-74	5100	-59(See Note2)	2.8	≤10.00
			4900	-53 (See Note2)	2.5	≤10.00
			5000		2.4	≤10.00
			5975		2.5	≤10.00

Note1: PER monitored by software.

7 Photographs

7.1 Spurious Emission Test Setup (below 1GHz)

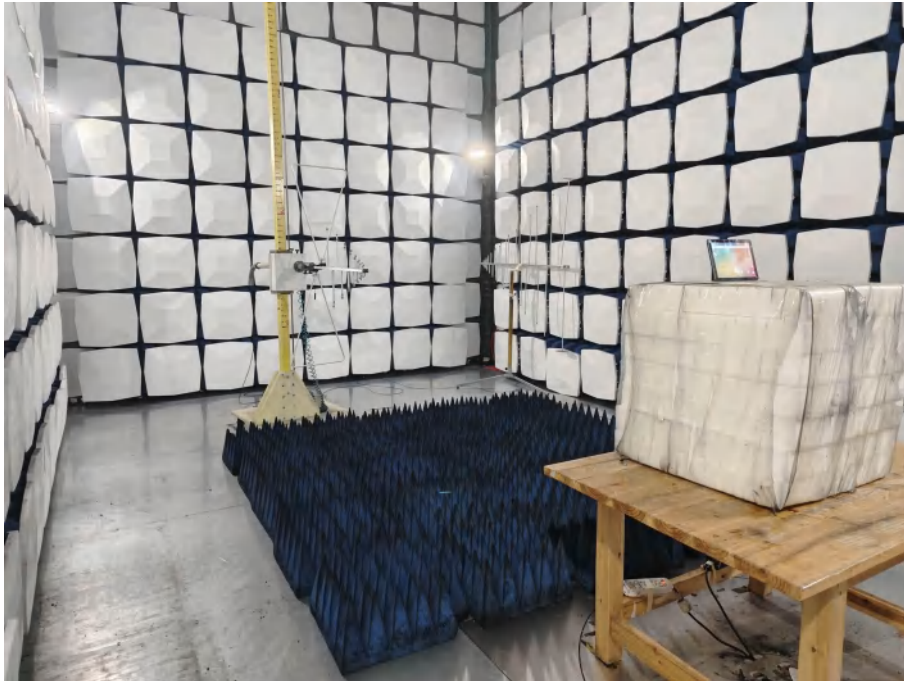

7.2 Spurious Emission Test Setup (above 1GHz)



End of report