



RADIO TEST REPORT

ETSI EN 300 328 V2.2.2 (2019-07)

Product : Tablet PC

Trade Mark : Blackview, OSCAL

Model Name : Tab 8 WiFi

Family Model : Tab 8 Kids, Pad 70

Report No. : STR230303001002E

Prepared for

DOKE COMMUNICATION (HK) LIMITED

RM 1902 EASEY COMM BLDG 253-261 HENNESSY ROAD WANCHAI HK CHINA

Prepared by

Shenzhen NTEK Testing Technology Co., Ltd.

1/F, Building E, Fenda Science Park, Sanwei Community, Xixiang Street
Bao'an District, Shenzhen 518126 P.R. China

Tel. 400-800-6106, 0755-2320 0050, 0755-2320 0090

Website: <http://www.ntek.org.cn>

TEST RESULT CERTIFICATION

Applicant's name.....: DOKE COMMUNICATION (HK) LIMITED
Address.....: RM 1902 EASEY COMM BLDG 253-261 HENNESSY ROAD
WANCHAI HK CHINA
Manufacturer's Name.....: Shenzhen DOKE Electronic Co.,Ltd
Address.....: 801, Building3, 7th Industrial Zone, Yulv Community, Yutang Road,
Guangming District, Shenzhen, China.

Product description

Product name.....: Tablet PC
Trademark.....: Blackview, OSCAL
Model Name.....: Tab 8 WiFi
Family Model.....: Tab 8 Kids, Pad 70

Standards.....: ETSI EN 300 328 V2.2.2 (2019-07)

This device described above has been tested by Shenzhen NTEK, and the test results show that the equipment under test (EUT) is in compliance with the 2014/53/EU RED Directive Art.3.2 requirements. And it is applicable only to the tested sample identified in the report.

This report shall not be reproduced except in full, without the written approval of Shenzhen NTEK, this document may be altered or revised by Shenzhen NTEK, personnel only, and shall be noted in the revision of the document.

Test Sample Number.....: T230303001R001

Date of Test.....

Date (s) of performance of tests.....: Mar 08. 2023 ~ Apr 07. 2023

Date of Issue.....: Apr 10. 2023

Test Result.....: Pass

Testing Engineer : [Signature]
(Allen Liu)

Authorized Signatory : [Signature]
(Alex Li)

Table of Contents

Page

1 . GENERAL INFORMATION	6
1.1 GENERAL DESCRIPTION OF EUT	6
1.2 INFORMATION ABOUT THE EUT	7
1.3 TEST CONDITIONS AND CHANNEL	12
1.4 DESCRIPTION OF TEST CONDITIONS	13
1.5 DESCRIPTION OF SUPPORT UNITS	14
1.6 EQUIPMENTS LIST FOR ALL TEST ITEMS	15
2 . SUMMARY OF TEST RESULTS	16
2.1 TEST FACILITY	17
2.2 MEASUREMENT UNCERTAINTY	17
3 . TEST PROCEDURES AND RESULTLS	18
3.1 EQUIVALENT ISOTROPIC RADIATED POWER	18
3.1.1 LIMITS OF EQUIVALENT ISOTROPIC RADIATED POWER	18
3.1.2 TEST PROCEDURE	18
3.1.3 TEST SETUP	18
3.1.4 TEST RESULTS	19
3.2 . PEAK POWER DENSITY	20
3.2.1 LIMITS OF POWER SPECTRAL DENSITY	20
3.2.2 TEST PROCEDURE	20
3.2.3 TEST SETUP	20
3.2.4 TEST RESULTS	21
3.3 . OCCUPIED CHANNEL BANDWIDTH	22
3.3.1 LIMITS OF OCCUPIED CHANNEL BANDWIDTH	22
3.3.2 TEST PROCEDURE	22
3.3.3 DEVIATION FROM TEST STANDARD	22
3.3.4 TEST SETUP	22
3.3.5 TEST RESULTS	23
3.4 . TRANSMITTER UNWANTED EMISSIONS IN THE OUT-OF-BAND DOMAIN	24
3.4.1 LIMITS OF TRANSMITTER UNWANTED EMISSIONS IN THE OUT-OF-BAND DOMAIN	24
3.4.2 TEST PROCEDURE	24
3.4.3 DEVIATION FROM TEST STANDARD	25
3.4.4 TEST SETUP	25
3.4.5 TEST RESULTS	26
3.5 . ADAPTIVE (CHANNEL ACCESS MECHANISM)	27
3.5.1 APPLICABILITY OF ADAPTIVE REQUIREMENTS AND LILIT FOR WIDE BAND MODULATION TECHNIQUES	27
3.5.2 TEST PROCEDURE	28
3.5.3 TEST SETUP CONFIGURATION	28
3.5.4 LIST OF MEASUREMENTS	29

Table of Contents	Page
3.5.5 TEST RESULTS	30
3.6 . TRANSMITTER UNWANTED EMISSIONS IN THE SPURIOUS DOMAIN	31
3.6.1 LIMITS OF TRANSMITTER UNWANTED EMISSIONS IN THE SPURIOUS DOMAIN	31
3.6.2 TEST PROCEDURE	31
3.6.3 DEVIATION FROM TEST STANDARD	31
3.6.4 TEST SETUP	32
3.6.5 TEST RESULTS(Radiated measurement)	33
3.6.6 TEST RESULTS (Conducted measurement)	34
3.7 . RECEIVER SPURIOUS RADIATION	35
3.7.1 LIMITS OF RECEIVER SPURIOUS RADIATION	35
3.7.2 TEST PROCEDURE	35
3.7.3 DEVIATION FROM TEST STANDARD	35
3.7.4 TEST SETUP	36
3.7.5 TEST RESULTS(Radiated measurement)	37
3.7.6 TEST RESULTS (Conducted measurement)	38
3.8 . RECEIVER BLOCKING	39
3.8.1 PERFORMANCE CRITERIA	39
3.8.2 LIMITS OF RECEIVER BLOCKING	39
3.8.3 TEST PROCEDURE	41
3.8.4 DEVIATION FROM TEST STANDARD	41
3.8.5 TEST SETUP	41
3.8.6 TEST RESULTS	42
4 . TEST RESULTS	44
1M:	44
4.1.1 RF Output Power	44
4.1.2 Power Spectral Density	47
4.1.3 Occupied Channel Bandwidth	50
4.1.4 Transmitter unwanted emissions in the out-of-band domain	53
4.1.5 Transmitter unwanted emissions in the spurious domain	55
4.1.6 Receiver spurious emissions	58
2M:	61
4.2.1 RF Output Power	61
4.2.2 Power Spectral Density	64
4.2.3 Occupied Channel Bandwidth	67
4.2.4 Transmitter unwanted emissions in the out-of-band domain	70
4.2.5 Transmitter unwanted emissions in the spurious domain	72
4.2.6 Receiver spurious emissions	75
5 . EUT TEST PHOTO	78
SPURIOUS EMISSIONS MEASUREMENT PHOTOS	78

Revision History

Report No.	Version	Description	Issued Date
STR230303001002E	Rev.01	Initial issue of report	Apr 10. 2023

1. GENERAL INFORMATION

1.1 GENERAL DESCRIPTION OF EUT

Equipment	Tablet PC	
Trade Mark	Blackview, OSCAL	
Model Name.	Tab 8 WiFi	
Family Model	Tab 8 Kids, Pad 70	
Model Difference	All the model are the same circuit and RF module,except the Trade Mark.	
Product Description	The EUT is Tablet PC	
	Operation Frequency:	2402~2480 MHz
	Modulation Type:	GFSK
	Adaptive/non-adaptive	Adaptive equipment
	Receiver categories	3
	Number Of Channel	Please see Note 2.
	Antenna Designation:	PIFA Antenna
	Antenna Gain(Peak)	3dBi
Channel List	Refer to below	
Adapter	Model: QZ-01000EA00 Input: 100-240V~50/60Hz 0.3A Output: 5.0V---2.0A (10.0W)	
Battery	Battery 1: DC 3.8V, 6580mAh Battery 2: DC 3.8V, 6580mAh	
Rating	DC 3.8V from battery or DC 5V from Adapter.	
I/O Ports	Refer to users manual	
Hardware Version	R863T-RK3566-DK-V1.0	
Software Version	Tab_8_WiFi_EEA_S863T_V1.0 Tab_8_Kids_EEA_S863T_V1.0 PAD_70_EEA_S863T_V1.0	

Note:

1. For a more detailed features description, please refer to the manufacturer's specifications or the User's Manual.

2.

Channel	Frequency (MHz)
00	2402
01	2404
.....
.....
38	2478
39	2480

1.2 INFORMATION ABOUT THE EUT

a) The type of modulation used by the equipment:

- FHSS
- other forms of modulation

b) In case of FHSS modulation:

- In case of non-Adaptive Frequency Hopping equipment:
The number of Hopping Frequencies:
- In case of Adaptive Frequency Hopping Equipment:
The maximum number of Hopping Frequencies:
The minimum number of Hopping Frequencies:
- The (average) Dwell Time:

c) Adaptive / non-adaptive equipment:

- non-adaptive Equipment
- adaptive Equipment without the possibility to switch to a non-adaptive mode
- adaptive Equipment which can also operate in a non-adaptive mode

d) In case of adaptive equipment:

The maximum Channel Occupancy Time implemented by the equipment: ./ ms

- The equipment has implemented an LBT based DAA mechanism
 - In case of equipment using modulation different from FHSS:
 - The equipment is Frame Based equipment
 - The equipment is Load Based equipment
 - The equipment can switch dynamically between Frame Based and Load Based equipment
- The CCA time implemented by the equipment: / μs

- The equipment has implemented a non-LBT based DAA mechanism
- The equipment can operate in more than one adaptive mode

e) In case of non-adaptive Equipment:

The maximum RF Output Power (e.i.r.p.):

The maximum (corresponding) Duty Cycle:

Equipment with dynamic behaviour, that behaviour is described here. (e.g. the different combinations of duty cycle and corresponding power levels to be declared):

f) The worst case operational mode for each of the following tests:

- RF Output Power
GFSK
- Power Spectral Density
GFSK
- Duty cycle, Tx-Sequence, Tx-gap
N/A
- Accumulated Transmit time, Frequency Occupation & Hopping Sequence (only for FHSS equipment)
N/A
- Hopping Frequency Separation (only for FHSS equipment)
N/A
- Medium Utilization
N/A
- Adaptivity
N/A
- Receiver Blocking
GFSK
- Nominal Channel Bandwidth
GFSK
- Transmitter unwanted emissions in the OOB domain
GFSK
- Transmitter unwanted emissions in the spurious domain
GFSK
- Receiver spurious emissions
GFSK

g) The different transmit operating modes (tick all that apply):

- Operating mode 1: Single Antenna Equipment
 - Equipment with only one antenna
 - Equipment with two diversity antennas but only one antenna active at any moment in time
 - Smart Antenna Systems with two or more antennas, but operating in a (legacy) mode where only one antenna is used (e.g. IEEE 802.11™ [i.3] legacy mode in smart antenna systems)
- Operating mode 2: Smart Antenna Systems - Multiple Antennas without beam forming
 - Single spatial stream / Standard throughput / (e.g. IEEE 802.11™ [i.3] legacy mode)

- High Throughput (> 1 spatial stream) using Nominal Channel Bandwidth 1
- High Throughput (> 1 spatial stream) using Nominal Channel Bandwidth 2

NOTE 1: Add more lines if more channel bandwidths are supported.

- Operating mode 3: Smart Antenna Systems - Multiple Antennas with beam forming
 - Single spatial stream / Standard throughput (e.g. IEEE 802.11™ [i.3] legacy mode)
 - High Throughput (> 1 spatial stream) using Nominal Channel Bandwidth 1
 - High Throughput (> 1 spatial stream) using Nominal Channel Bandwidth 2

NOTE 2: Add more lines if more channel bandwidths are supported.

h) In case of Smart Antenna Systems:

- The number of Receive chains:
- The number of Transmit chains:
 - symmetrical power distribution
 - asymmetrical power distribution

In case of beam forming, the maximum (additional) beam forming gain: dB

NOTE: The additional beam forming gain does not include the basic gain of a single antenna.

i) Operating Frequency Range(s) of the equipment:

- Operating Frequency Range 1: 2402 MHz to 2480 MHz
 - Operating Frequency Range 2: MHz to MHz
- NOTE: Add more lines if more Frequency Ranges are supported.

j) Nominal Channel Bandwidth(s):

- Nominal Channel Bandwidth 1: 1.031MHz(1M)
 - Nominal Channel Bandwidth 2: 2.074MHz(2M)
- NOTE: Add more lines if more channel bandwidths are supported.

k) Type of Equipment (stand-alone, combined, plug-in radio device, etc.):

- Stand-alone
- Combined Equipment (Equipment where the radio part is fully integrated within another type of equipment)
- Plug-in radio device (Equipment intended for a variety of host systems)
- Other

l) The normal and the extreme operating conditions that apply to the equipment:

Normal operating conditions (if applicable):

Operating temperature: 15°C~35°C
 Other (please specify if applicable):

Extreme operating conditions:

Operating temperature range: Minimum: -10°C Maximum 40°C
 Other (please specify if applicable): Minimum: Maximum

Details provided are for the:

- stand-alone equipment
- combined (or host) equipment
- test jig

m) The intended combination(s) of the radio equipment power settings and one or more antenna assemblies and their corresponding e.i.r.p. levels:

- Antenna Type: PIFA Antenna

Integral Antenna (information to be provided in case of conducted measurements)

Antenna Gain: 3dBi

If applicable, additional beamforming gain (excluding basic antenna gain): dB

Temporary RF connector provided

No temporary RF connector provided

Dedicated Antennas (equipment with antenna connector)

Single power level with corresponding antenna(s)

Multiple power settings and corresponding antenna(s)

Number of different Power Levels:

Power Level 1: dBm

Power Level 2: dBm

Power Level 3: dBm

NOTE 1: Add more lines in case the equipment has more power levels.

NOTE 2: These power levels are conducted power levels (at antenna connector).

- For each of the Power Levels, provide the intended antenna assemblies, their corresponding gains (G) and the resulting e.i.r.p. levels also taking into account the beamforming gain (Y) if applicable

Power Level 1: dBm

Number of antenna assemblies provided for this power level:

Assembly #	Gain (dBi)	e.i.r.p. (dBm)	Part number or model name
1M	3	-0.93	
2M	3	-1.07	

NOTE 3: Add more rows in case more antenna assemblies are supported for this power level.

Power Level 2: dBm

Number of antenna assemblies provided for this power level:

Assembly #	Gain (dBi)	e.i.r.p. (dBm)	Part number or model name
1			
2			
3			

NOTE 4: Add more rows in case more antenna assemblies are supported for this power level.

Power Level 3: dBm

Number of antenna assemblies provided for this power level:

Assembly #	Gain (dBi)	e.i.r.p. (dBm)	Part number or model name
1			
2			
3			

NOTE 5: Add more rows in case more antenna assemblies are supported for this power level.

n) The nominal voltages of the stand-alone radio equipment or the nominal voltages of the combined (host) equipment or test jig in case of plug-in devices:

Details provided are for the:

- stand-alone equipment
- combined (or host) equipment
- test jig

Supply Voltage AC mains State AC voltage V
 DC State DC voltage: DC 3.8V

In case of DC, indicate the type of power source

- Internal Power Supply
- External Power Supply or AC/DC adapter: DC 5V
- Battery: DC 3.8V
- Other:

o) Describe the test modes available which can facilitate testing:

See clause 1.3

p) The equipment type (e.g. Bluetooth®, IEEE 802.11™ [i.3], IEEE 802.15.4™ [i.4], proprietary, etc.):

Bluetooth®

q) If applicable, the statistical analysis referred to in clause 5.4.1 q)

(to be provided as separate attachment)

r) If applicable, the statistical analysis referred to in clause 5.4.1 r)

(to be provided as separate attachment)

s) Geo-location capability supported by the equipment:

- Yes
- The geographical location determined by the equipment as defined in clause 4.3.1.13.2 or clause 4.3.2.12.2 is not accessible to the user
- No

t) Describe the minimum performance criteria that apply to the equipment (see clause 4.3.1.12.3 or clause 4.3.2.11.3):

GFSK(CH00)=0.79%(1M), GFSK(CH00)=0.71%(2M)

1.3 TEST CONDITIONS AND CHANNEL

	Normal Test Conditions	Extreme Test Conditions
Temperature	15°C - 35°C	40°C ~ -10°C Note: (1)
Relative Humidity	20% - 75%	N/A
Supply Voltage	DC 3.8V	/

Test Channel	EUT Channel	Test Frequency (MHz)
Lowest	CH00	2402
Middle	CH19	2440
Highest	CH39	2480

Note:

- (1) The HT 40°C and LT -10°C was declared by manufacturer, The EUT couldn't be operate normally with higher or lower temperature.
- (2) The measurements are performed at the highest, middle, lowest available channels.

1.4 DESCRIPTION OF TEST CONDITIONS

**E-1
EUT**

1.5 DESCRIPTION OF SUPPORT UNITS

The EUT has been tested as an independent unit together with other necessary accessories or support units. The following support units or accessories were used to form a representative test configuration during the tests.

Item	Equipment	Model/Type No.	Series No.	Note
E-1	Tablet PC	Tab 8 WiFi	N/A	EUT

Item	Type	Shielded Type	Ferrite Core	Length	Note

Note:

- (1) The support equipment was authorized by Declaration of Confirmation.
- (2) For detachable type I/O cable should be specified the length in cm in 『Length』 column.

1.6 EQUIPMENTS LIST FOR ALL TEST ITEMS

EQUIPMENT TYPE	Manufacturer	Type No.	Serial No.	Last calibration	Calibrated until	Calibration period
EMI Test Receiver	R&S	ESPI7	101318	2022.04.06 2023.03.27	2023.04.05 2024.03.26	1 year
Bilog Antenna	TESEQ	CBL6111D	31216	2022.03.30 2023.03.27	2023.03.29 2024.03.26	1 year
Turn Table	EM	SC100_1	60531	N/A	N/A	N/A
Antnna Mast	EM	SC100	N/A	N/A	N/A	N/A
Horn Antenna	EM	EM-AH-10180	2011071402	2023.01.12	2024.01.11	1 year
Horn Ant	Schwarzbeck	BBHA 9170	9170-181	2022.04.01 2023.03.27	2023.03.31 2024.03.26	1 year
Test Cable (30MHz-1GHz)	N/A	R-01	N/A	2022.06.17	2025.06.16	3 year
Test Cable (1-18GHz)	N/A	R-02	N/A	2022.06.17	2025.06.16	3 year
50Ω Coaxial Switch	Anritsu	MP59B	6200983705	2020.05.11	2023.05.10	3 year
Pre-Amplifier	EMC	EMC051835SE	980246	2022.06.17	2023.06.16	1 year
Spectrum Analyzer	Agilent	E4407B	MY45108040	2022.04.01 2023.03.27	2023.03.31 2024.03.26	1 year
Filter	TRILTHIC	2400MHz	29	2020.04.07 2023.03.27	2023.04.06 2024.03.26	3 year
Attenuator	Weinschel	33-10-33	AR4010	2020.04.07 2023.03.27	2023.04.06 2024.03.26	3 year
Attenuator	Weinschel	24-20-34	BP4485	2020.04.07 2023.03.27	2023.04.06 2024.03.26	3 year
MXA Signal Analyzer	Agilent	N9020A	MY49100060	2022.06.17	2023.06.16	1 year
ESG VETCTOR SIGNAL GENERAROR	Agilent	E4438C	MY45093347	2022.04.01 2023.03.21	2023.03.31 2024.03.20	1 year
PSG Analog Signal Generator	Agilent	E8257D	MY51110112	2022.06.17	2023.06.16	1 year
Power Splitter	Mini-Circuits/ USA	ZN2PD-63-S+	SF025101428	2020.04.07 2023.03.27	2023.04.06 2024.03.26	3 year
Coupler	Mini-Circuits	ZADC-10-63-S +	SF794101410	2020.04.07 2023.03.27	2023.04.06 2024.03.26	3 year
Directional Coupler	MCLI/USA	CB11-20	0D2L51502	2020.07.17	2023.07.16	3 year
Attenuator	Agilent	8495B	MY42147029	2020.04.07 2023.03.27	2023.04.06 2024.03.26	3 year
Power Meter	DARE	RPR3006W	15I00041SNO 84	2022.06.17	2023.06.16	1 year
MXG Vector Signal Generator	Agilent	N5182A	MY47070317	2022.04.01 2023.03.27	2023.03.31 2024.03.26	1 year
Wideband Radio Communication Tester Specifications	R&S	CMW500	148500	2022.04.01 2023.03.27	2023.03.31 2024.03.26	1 year
temporary antenna connector (Note)	NTS	R001	N/A	N/A	N/A	N/A

Note:

We will use the temporary antenna connector (soldered on the PCB board) When conducted test
And this temporary antenna connector is listed within the instrument list

2. SUMMARY OF TEST RESULTS

The EUT has been tested according to the following specifications:

ETSI EN 300 328 V2.2.2 (2019-07)		
Clause	Test Item	Results
TRANSMITTER PARAMETERS		
4.3.2.2	RF Output Power	Pass
4.3.2.3	Power Spectral Density	Pass
4.3.2.4	Duty cycle, Tx-Sequence, Tx-gap	Not Applicable (See Note 1/2)
4.3.2.5	Medium Utilization (MU) factor	Not Applicable (See Note 1/2)
4.3.2.6	Adaptivity	Not Applicable (See Note 1)
4.3.2.7	Occupied Channel Bandwidth	Pass
4.3.2.8	Transmitter unwanted emission in the OOB domain	Pass
4.3.2.9	Transmitter unwanted emissions in the spurious domain	Pass
RECEIVER PARAMETERS		
4.3.2.10	Receiver Spurious Emissions	Pass
4.3.2.11	Receiver Blocking	Pass

Note:

1. These requirements do not apply for equipment with a maximum declared RF output power of less than 10 dBm EIRP or for equipment when operating in a mode where the RF output power is less than 10 dBm EIRP.
2. These requirements apply to non-adaptive frequency hopping equipment or to adaptive frequency hopping equipment operating in a non-adaptive mode
3. The antenna gain provided by customer is used to calculate the EIRP result. NTEK is not responsible for the accuracy of antenna gain parameter.

2.1 TEST FACILITY

Shenzhen NTEK Testing Technology Co., Ltd.

Add. : 1/F, Building E, Fenda Science Park, Sanwei Community, Xixiang Street, Bao'an District, Shenzhen 518126 P.R. China

FCC Registered No.: 463705 IC Registered No.:9270A-1

CNAS Registration No.:L5516

2.2 MEASUREMENT UNCERTAINTY

For the test methods, according to ETSI EN 300 328 standard, the measurement uncertainty figures shall be calculated in accordance with ETR 100 028-1[4] and shall correspond to an expansion factor(coverage factor) $k=1.96$ or $k=2$ (which provide confidence levels of respectively **95 %** and **95.45 %** in the case where the distributions characterizing the actual measurement uncertainties are normal (Gaussian)).

Measurement uncertainty

No.	Item	Uncertainty (P=95)
1	Occupied Channel Bandwidth	$\pm 4.7\%$
2	RF output Power,conducted	$\pm 0.9\text{dB}$
3	Power Spectral Density, conducted	$\pm 2.6\text{dB}$
4	Unwanted emissions, conducted	$\pm 2.2\text{dB}$
5	All emissions,radiated	$\pm 5.3\text{dB}$
6	Temperature	$\pm 0.5^{\circ}\text{C}$
7	Humidity	$\pm 2.0\%$
8	Time	$\pm 1.0\%$

3. TEST PROCEDURES AND RESULTS

3.1 EQUIVALENT ISOTROPIC RADIATED POWER

3.1.1 LIMITS OF EQUIVALENT ISOTROPIC RADIATED POWER

Refer to chapter 4.3.2.2.3 of ETSI EN 300 328 V2.2.2 (2019-07)

RF OUTPUT POWER	
Condition	Limit
<input type="checkbox"/> Non-adaptive wide band modulations systems	Equal to or less than the value declared by the supplier. This declared value shall be equal to or less than 20 dBm.
<input checked="" type="checkbox"/> Adaptive wide band modulations systems	≤20dBm

3.1.2 TEST PROCEDURE

Refer to chapter 5.4.2.2 of ETSI EN 300 328 V2.2.2 (2019-07)

Measurement	
<input checked="" type="checkbox"/> Conducted measurement	<input type="checkbox"/> Radiated measurement

3.1.3 TEST SETUP

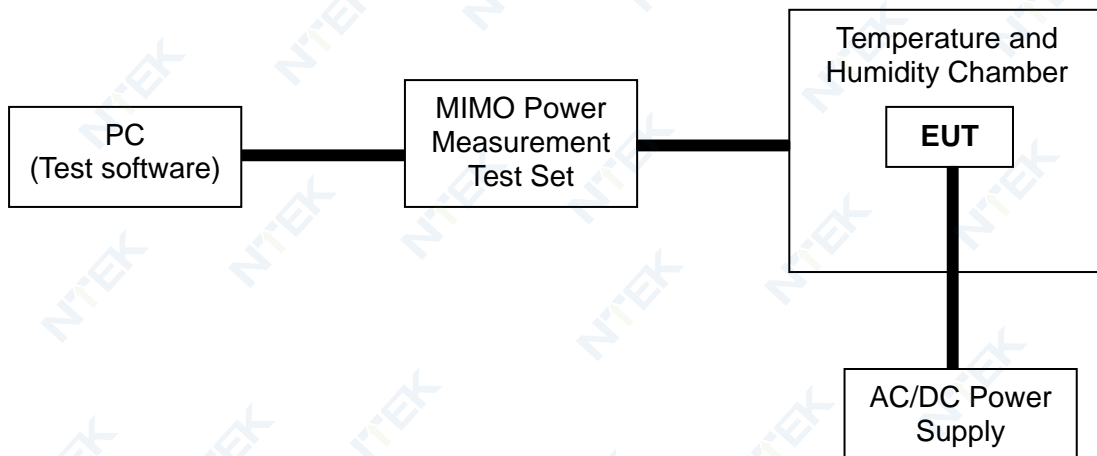

3.1.4 TEST RESULTS

EUT :	Tablet PC	Model Name :	Tab 8 WiFi
Temperature :	20°C	Relative Humidity:	55 %
Pressure :	1012 hPa	Test Voltage :	DC 3.8V
Test Mode :	TX Low channel / Middle Channel / High Channel		

Test data reference attachment

3.2. PEAK POWER DENSITY

3.2.1 LIMITS OF POWER SPECTRAL DENSITY

Refer to chapter 4.3.2.3.3 of ETSI EN 300 328 V2.2.2 (2019-07)

RF OUTPUT POWER	
Condition	Limit
For equipment using wide band modulations other than FHSS	≤10 dBm/MHz

3.2.2 TEST PROCEDURE

Refer to chapter 5.4.3.2 of ETSI EN 300 328 V2.2.2 (2019-07)

Measurement	
<input checked="" type="checkbox"/> Conducted measurement	<input type="checkbox"/> Radiated measurement

The setting of the Spectrum Analyzer

Start Frequency	2400MHz
Stop Frequency	2483.5MHz
Detector	RMS
Sweep Point	> 8 350; for spectrum analysers not supporting this number of sweep points, the frequency band may be segmented
Sweep time:	For non-continuous transmissions: 2 × Channel Occupancy Time × number of sweep points For continuous transmissions: 10 s; the sweep time may be increased further until a value where the sweep time has no further impact anymore on the RMS value of the signal.
RBW / VBW	10KHz / 30KHz

3.2.3 TEST SETUP

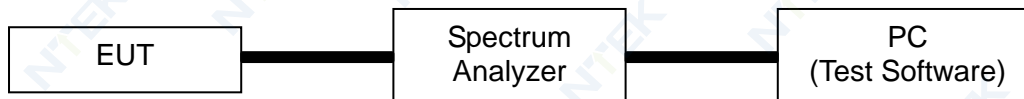

3.2.4 TEST RESULTS

EUT :	Tablet PC	Model Name :	Tab 8 WiFi
Temperature :	26°C	Relative Humidity:	60 %
Pressure :	1012 hPa	Test Voltage :	DC 3.8V
Test Mode :	TX-GFSK(CH00/CH19/CH39)		

Test data reference attachment

3.3. OCCUPIED CHANNEL BANDWIDTH

3.3.1 LIMITS OF OCCUPIED CHANNEL BANDWIDTH

Refer to chapter 4.3.2.7.3 of ETSI EN 300 328 V2.2.2 (2019-07)

OCCUPIED CHANNEL BANDWIDTH		
Condition		Limit
All types of equipment using wide band modulations other than FHSS		Shall fall completely within the band 2400 to 2483.5 MHz
Additional requirement	For non-adaptive using wide band modulations other than FHSS system and E.I.R.P >10 dBm	Less than 20 MHz
	For non-adaptive frequency hopping system and E.I.R.P >10 dBm	Less than 5 MHz

3.3.2 TEST PROCEDURE

Refer to chapter 5.4.7.2 of ETSI EN 300 328 V2.2.2 (2019-07)

Measurement	
<input checked="" type="checkbox"/> Conducted measurement	<input type="checkbox"/> Radiated measurement

The setting of the Spectrum Analyzer

Center Frequency	The centre frequency of the channel under test
Frequency Span	2 x Nominal Channel Bandwidth
Detector	RMS
RBW	~ 1 % of the span without going below 1 %
VBW	3 x RBW
Trace	Max hold
Sweep time	1s

3.3.3 DEVIATION FROM TEST STANDARD

No deviation

3.3.4 TEST SETUP



These measurements only were performed at normal test conditions. The measurement shall be performed only on the lowest and the highest frequency within the ststed frequency range. In case of conducted measurements the transmitter shall be connected to the measuring equipment via a suitable attenuator. Controlling software has been activated to set the EUT on specific status.

3.3.5 TEST RESULTS

EUT :	Tablet PC	Model Name :	Tab 8 WiFi
Temperature :	26°C	Relative Humidity :	60 %
Pressure :	1012 hPa	Test Voltage :	DC 3.8V
Test Mode :	TX-GFSK(CH00/CH19/CH39)		

Test data reference attachment

3.4. TRANSMITTER UNWANTED EMISSIONS IN THE OUT-OF-BAND DOMAIN

3.4.1 LIMITS OF TRANSMITTER UNWANTED EMISSIONS IN THE OUT-OF-BAND DOMAIN

Refer to chapter 4.3.2.8.3 of ETSI EN 300 328 V2.2.2 (2019-07)

TRANSMITTER UNWANTED EMISSIONS IN THE OUT-OF-BAND DOMAIN	
Condition	Limit
Under all test conditions	The transmitter unwanted emissions in the out-of-band domain but outside the allocated band, shall not exceed the values provided by the mask in below figure.

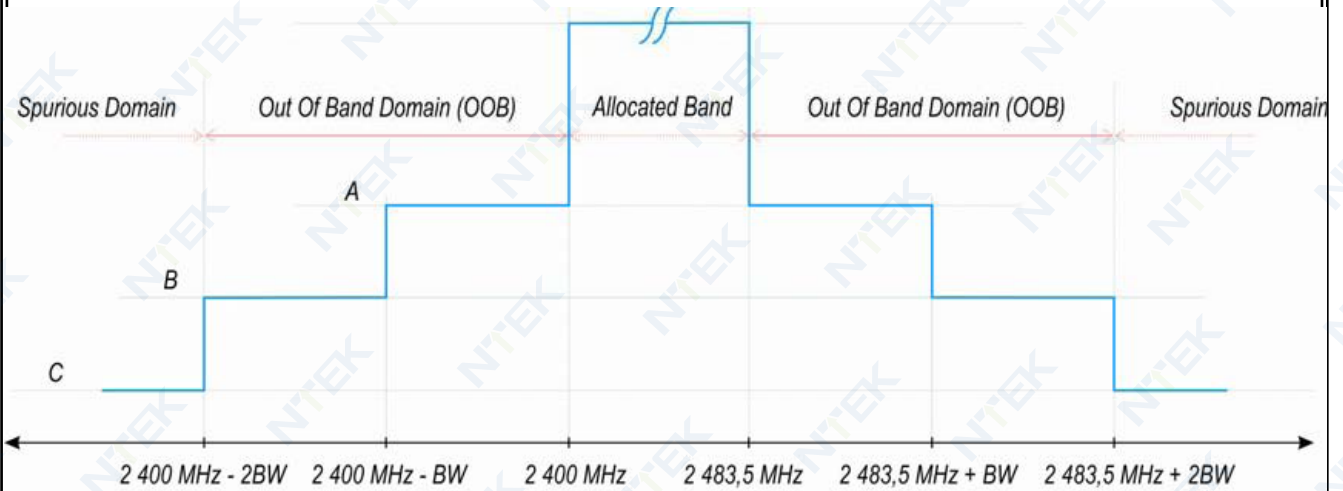

A: -10 dBm/MHz e.i.r.p.

B: -20 dBm/MHz e.i.r.p.

C: Spurious Domain limits

BW = Occupied Channel Bandwidth in MHz or 1 MHz whichever is greater

3.4.2 TEST PROCEDURE

Refer to chapter 5.4.8.2 of ETSI EN 300 328 V2.2.2 (2019-07)

Measurement	
<input checked="" type="checkbox"/> Conducted measurement	<input type="checkbox"/> Radiated measurement

The setting of the Spectrum Analyzer

Span	0Hz
Filter Mode	Channel Filter
Trace Mode	Max Hold
Trigger Mode	Video trigger; in case video triggering is not possible, an external trigger source may be used
Detector	RMS
Sweep Point / Sweep Mode	Sweep Time [s] / (1 μs) or 5 000 whichever is greater/ Continuous
RBW / VBW	1MHz / 3MHz

3.4.3 DEVIATION FROM TEST STANDARD

No deviation

3.4.4 TEST SETUP

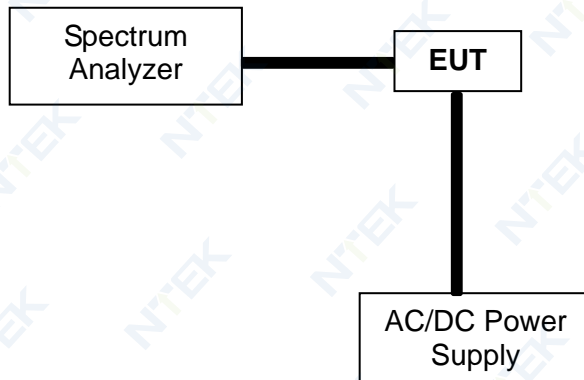

According to the EN 300328 V2.2.2 clause 5.4.8.1: These measurements shall only be performed at normal test conditions. For equipment using FHSS modulation, the measurements shall be performed during normal operation (hopping).

For equipment using wide band modulations other than FHSS, the measurement shall be performed at the lowest and the highest channel on which the equipment can operate. These operating channels shall be recorded.

The equipment shall be configured to operate under its worst case situation with respect to output power.

If the equipment can operate with different Nominal Channel Bandwidths (e.g. 20 MHz and 40 MHz), then each channel bandwidth shall be tested separately.

3.4.5 TEST RESULTS

EUT :	Tablet PC	Model Name :	Tab 8 WiFi
Temperature :	24 °C	Relative Humidity :	54%
Pressure :	1010 hPa	Test Power :	DC 3.8V
Test Mode :	TX-GFSK(CH00/CH39)		

Test data reference attachment

3.5. ADAPTIVE (CHANNEL ACCESS MECHANISM)

3.5.1 APPLICABILITY OF ADAPTIVE REQUIREMENTS AND LILIT FOR WIDE BAND MODULATION TECHNIQUES

Refer to chapter ETSI EN 300 328 V2.2.2 (2019-07)

Requirement	Operational Mode			
	<input type="checkbox"/> Non-LBT based Detect and Avoid	<input type="checkbox"/> LBT based Detect and Avoid		
		<input type="checkbox"/> Frame Based Equipment	<input type="checkbox"/> Load Based Equipment (CCA using 'energy detect')	<input type="checkbox"/> Load Based Equipment (CCA not using any of the mechanisms referenced as note 2)
Minimum Clear Channel Assessment (CCA) Time	NA	not less than 18 us (see note 1)	(see note 2)	not less than 18 us (see note 1)
Maximum Channel Occupancy (COT) Time	< 40 ms	1ms to 10 ms	(see note 2)	(13/32)*q ms (see note 3)
Minimum Idle Period	5 % minimum of 100 μs	5% of COT	(see note 2)	NA
Extended CCA check	NA	NA	(see note 2)	R*CCA (see note 4)
Short Control Signalling Transmissions	Maximum duty cycle of 10% within an observation period of 50 ms (see note 5)			

Note 1: The CCA time used by the equipment shall be declared by the supplier.

Note 2: Load Based Equipment may implement an LBT based spectrum sharing mechanism based on the Clear Channel Assessment (CCA) mode using energy detect as described in IEEE 802.11™-2012 [i.3], clause 9, clause 10, clause 16, clause 17, clause 19 and clause 20, or in IEEE 802.15.4™-2011 [i.4], clause 4, clause 5 and clause 8 providing the equipment complies with the conformance requirements referred to in clause 4.3.2.6.3.4.

Note 3: q is selected by the manufacturer in the range [4...32]

Note 4: The value of R shall be randomly selected in the range [1...q]

Note 5: Adaptive equipment may or may not have Short Control Signaling Transmissions.

Interference threshold level

The detection threshold shall be proportional to the transmit power of the transmitter: for a 20 dBm e.i.r.p. transmitter the detection threshold level (TL) shall be equal to or less than -70 dBm/MHz at the input to the receiver assuming a 0 dBi (receive) antenna assembly. This threshold level (TL) may be corrected for the (receive) antenna assembly gain (G); however, beamforming gain (Y) shall not be taken into account. For power levels less than 20 dBm e.i.r.p., the detection threshold level may be relaxed to:

$$TL = -70 \text{ dBm/MHz} + 10 \times \log_{10} (100 \text{ mW} / P_{out}) \text{ (P}_{out} \text{ in mW e.i.r.p.)}$$

Table 9: Unwanted Signal parameters

Wanted signal mean power from companion device (dBm)	Unwanted signal frequency (MHz)	Unwanted CW signal power (dBm)
-30/ sufficient to maintain the link(see note 2)	2 395 or 2 488,5 (see note 1)	-35 (see note 2)

NOTE 1: The highest frequency shall be used for testing operating channels within the range 2 400 MHz to 2 442 MHz, while the lowest frequency shall be used for testing operating channels within the range 2 442 MHz to 2 483,5 MHz. See clause 5.4.6.1.

NOTE 2: A typical value which can be used in most cases is -50 dBm/MHz.

NOTE 3: The level specified is the level in front of the UUT antenna. In case of conducted measurements, this level has to be corrected by the actual antenna assembly gain.

3.5.2 TEST PROCEDURE

Refer to chapter 5.4.6.2 of ETSI EN 300 328 V2.2.2 (2019-07)

Measurement	
<input checked="" type="checkbox"/> Conducted measurement	<input type="checkbox"/> Radiated measurement

Test method please refer to the 5.4.6.2.1.4 of ETSI EN 300 328 V2.2.2 (2019-07)

3.5.3 TEST SETUP CONFIGURATION

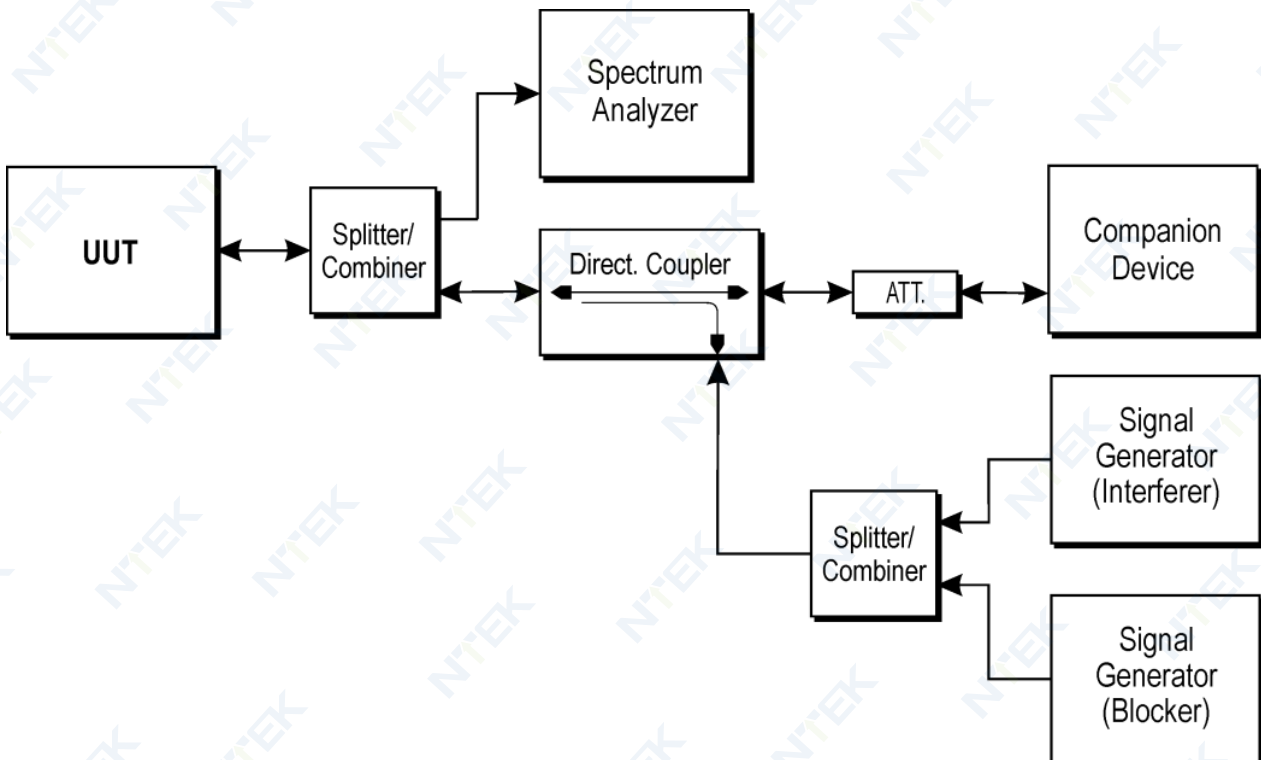

3.5.4 LIST OF MEASUREMENTS

UUT operational Mode		
Frame Based Equipment	Load Based Equipment (CCA using 'energy detect')	Load Based Equipment (CCA not using any of the mechanisms referenced)
	V	

Clause	Test Parameter	Remarks	PASS/FAIL
4.3.2.5.2.2.1	Adaptive (Frame Based Equipment)	Not Applicable	N/A
4.3.2.5.2.2.2	Adaptive (Load Based Equipment)	N/A	N/A
4.3.2.5.3	Short Control Signaling Transmissions	N/A	N/A

3.5.5 TEST RESULTS

EUT :	Tablet PC	Model Name :	Tab 8 WiFi
Temperature :	24 °C	Relative Humidity :	54%
Pressure :	1010 hPa	Test Power :	N/A
Test Mode :	N/A		

Note: Not Applicable

3.6. TRANSMITTER UNWANTED EMISSIONS IN THE SPURIOUS DOMAIN

3.6.1 LIMITS OF TRANSMITTER UNWANTED EMISSIONS IN THE SPURIOUS DOMAIN

Refer to chapter 4.3.2.9.3 of ETSI EN 300 328 V2.2.2 (2019-07)

TRANSMITTER UNWANTED EMISSIONS IN THE SPURIOUS DOMAIN		
Frequency Range	Maximum Power Limit (E.R.P.(≤1 GHz) E.I.R.P.(> 1 GHz))	Bandwidth
30 MHz to 47 MHz	-36dBm	100 kHz
47 MHz to 74 MHz	-54dBm	100 kHz
74 MHz to 87.5 MHz	-36dBm	100 kHz
87.5 MHz to 118 MHz	-54dBm	100 kHz
118 MHz to 174 MHz	-36dBm	100 kHz
174 MHz to 230 MHz	-54dBm	100 kHz
230 MHz to 470 MHz	-36dBm	100 kHz
470 MHz to 694 MHz	-54dBm	100 kHz
694 MHz to 1 GHz	-36dBm	100 kHz
1 GHz ~ 12.75 GHz	-30dBm	1 MHz

3.6.2 TEST PROCEDURE

Refer to chapter 5.4.9.2 of ETSI EN 300 328 V2.2.2 (2019-07)

Measurement	
<input checked="" type="checkbox"/> Conducted measurement	<input checked="" type="checkbox"/> Radiated measurement

The setting of the Spectrum Analyzer

RBW	100K(<1GHz) / 1M(>1GHz)
VBW	300K(<1GHz) / 3M(>1GHz)

3.6.3 DEVIATION FROM TEST STANDARD

No deviation

3.6.4 TEST SETUP

Radiated measurement:

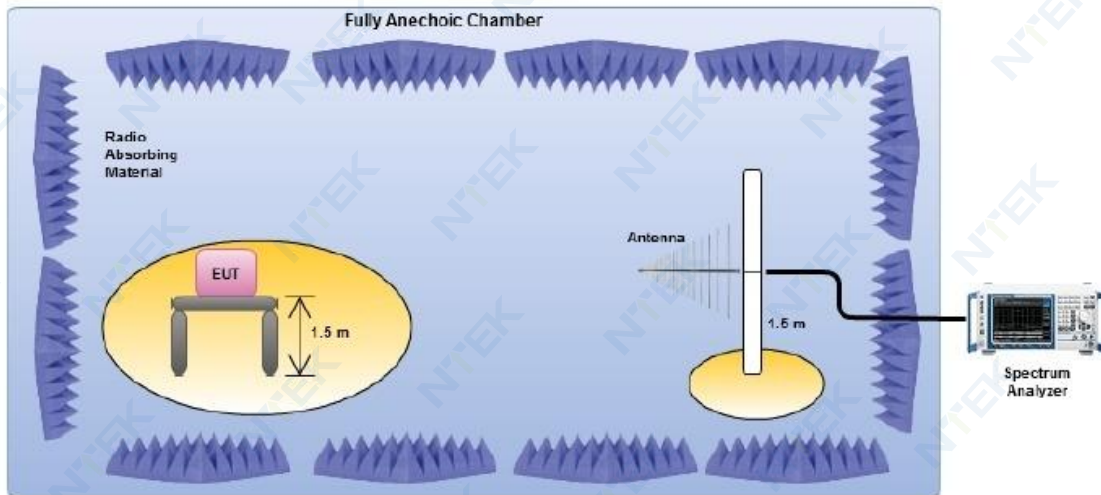

Conducted measurement:



1. For the actual test configuration, please refer to the related Item in this test report (Photographs of the Test Configuration).
2. The measurements were performed when normal hopping was disabled. In this case measurements were performed when operating at the lowest and the highest hopping frequency.
3. The equipment was configured to operate under its worst case situation with respect to output power.
4. The test setup has been constructed as the normal use condition. Controlling software has been activated to set the EUT on specific status.

3.6.5 TEST RESULTS(Radiated measurement)

BELOW 1 GHz WORST- CASE DATA(30 MHz ~ 1GHz)

EUT :	Tablet PC	Model Name :	Tab 8 WiFi
Temperature :	24°C	Relative Humidity :	57 %
Pressure :	1012 hPa	Test Voltage :	DC 3.8V
Test Mode :	TX--GFSK(CH19)		

Polar (H/V)	Frequency	Meter Reading	Factor	Emission Level	Limits	Margin	Remark
	(MHz)	(dBm)	(dB)	(dBm)	(dBm)	(dB)	
V	36.271	-76.47	11.08	-65.39	-36	-29.39	peak
V	113.403	-77.94	9.95	-67.99	-54	-13.99	peak
V	185.897	-72.21	11.04	-61.17	-54	-7.17	peak
V	240.324	-77.82	9.57	-68.25	-36	-32.25	peak
V	527.674	-76.69	10.86	-65.83	-54	-11.83	peak
H	46.118	-70.8	10.51	-60.29	-36	-24.29	peak
H	89.975	-72.12	9.86	-62.26	-54	-8.26	peak
H	192.984	-71.98	9.67	-62.31	-54	-8.31	peak
H	432.186	-73.12	11.36	-61.76	-36	-25.76	peak
H	647.597	-71.8	10.32	-61.48	-54	-7.48	peak

Remark:

- 1.Emission Level= Meter Reading+ Factor, Margin= Limit- Emission Level.
- 2.All the modes had been tested, but only the worst data recorded in the report.

ABOVE 1 GHz WORST- CASE DATA (1GHz ~ 12.75GHz)

EUT :	Tablet PC	Model Name :	Tab 8 WiFi
Temperature :	26°C	Relative Humidity :	60 %
Pressure :	1012 hPa	Test Voltage :	DC 3.8V
Test Mode :	TX-GFSK (CH00/CH19/CH39)		

Polar (H/V)	Frequency	Meter Reading	Factor	Emission Level	Limits	Margin	Remark
	(MHz)	(dBm)	(dB)	(dBm)	(dBm)	(dB)	
operation frequency:2402							
V	2511.556	-76.08	10.04	-66.04	-30	-36.04	peak
V	4925.816	-70.78	9.58	-61.20	-30	-31.20	peak
V	2822.073	-73.01	10.53	-62.48	-30	-32.48	peak
V	4030.749	-72.06	10.65	-61.41	-30	-31.41	peak
H	2703.188	-72.82	10.83	-61.99	-30	-31.99	peak
H	4500.105	-76.58	11.07	-65.51	-30	-35.51	peak
H	2821.346	-69.78	10.74	-59.04	-30	-29.04	peak
H	4867.006	-68.53	11.31	-57.22	-30	-27.22	peak
operation frequency:2440							
V	2160.75	-73.71	10.97	-62.74	-30	-32.74	peak
V	3091.78	-70.61	9.77	-60.84	-30	-30.84	peak
V	2959.703	-75.04	11.48	-63.56	-30	-33.56	peak
V	3206.376	-70.09	10.84	-59.25	-30	-29.25	peak
H	2039.687	-71.6	9.93	-61.67	-30	-31.67	peak
H	5130.862	-71.97	11.34	-60.63	-30	-30.63	peak
H	2121.08	-76.58	9.65	-66.93	-30	-36.93	peak
H	4406.641	-70.88	9.59	-61.29	-30	-31.29	peak
operation frequency:2480							
V	2700.342	-71.64	9.93	-61.71	-30	-31.71	peak
V	3039.947	-72.59	10.19	-62.40	-30	-32.40	peak
V	2218.652	-68.53	10.59	-57.94	-30	-27.94	peak
V	4569.854	-68.04	11.39	-56.65	-30	-26.65	peak
H	2844.35	-70.49	9.99	-60.50	-30	-30.50	peak
H	5530.54	-73.65	11.47	-62.18	-30	-32.18	peak
H	2105.768	-73.33	10.96	-62.37	-30	-32.37	peak
H	5614.409	-76.63	10.50	-66.13	-30	-36.13	peak

Remark:

1. Emission Level= Meter Reading+ Factor, Margin= Limit- Emission Level.
2. All the modes had been tested, but only the worst data recorded in the report.

3.6.6 TEST RESULTS (Conducted measurement)

Test data reference attachment

3.7. RECEIVER SPURIOUS RADIATION

3.7.1 LIMITS OF RECEIVER SPURIOUS RADIATION

Refer to chapter 4.3.2.10.3 of ETSI EN 300 328 V2.2.2 (2019-07)

RECEIVER SPURIOUS EMISSIONS		
Frequency Range	Maximum Power Limit (E.R.P.(≤1 GHz) E.I.R.P.(> 1 GHz))	Measurement Bandwidth
30 MHz ~ 1 GHz	-57dBm	100KHz
1 GHz ~ 12.75 GHz	-47dBm	1MHz

3.7.2 TEST PROCEDURE

Refer to chapter 5.4.10.2 of ETSI EN 300 328 V2.2.2 (2019-07)

Measurement	
<input checked="" type="checkbox"/> Conducted measurement	<input checked="" type="checkbox"/> Radiated measurement

The setting of the Spectrum Analyzer

RBW	100K(<1GHz) / 1M(>1GHz)
VBW	300K(<1GHz) / 3M(>1GHz)

3.7.3 DEVIATION FROM TEST STANDARD

No deviation

3.7.4 TEST SETUP

Radiated measurement:

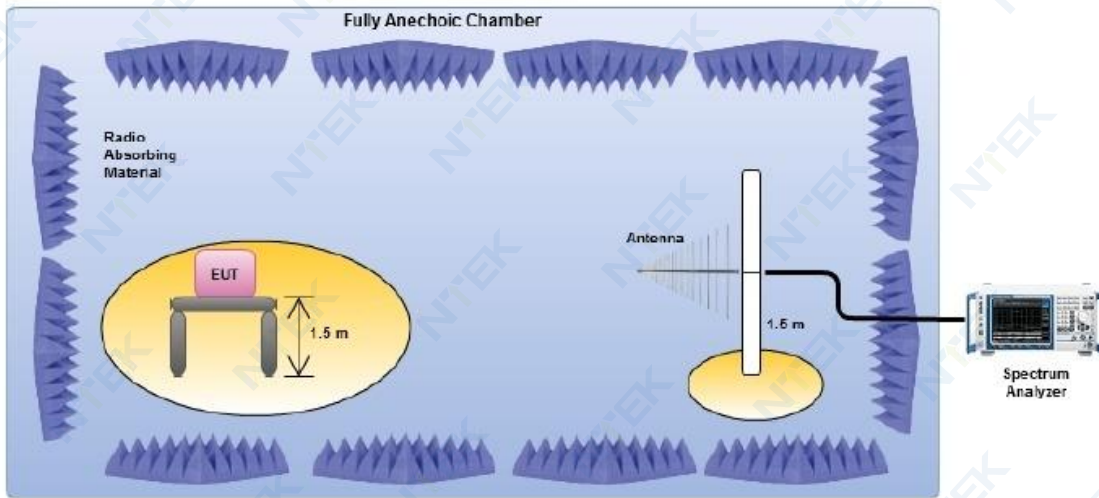

Conducted measurement:

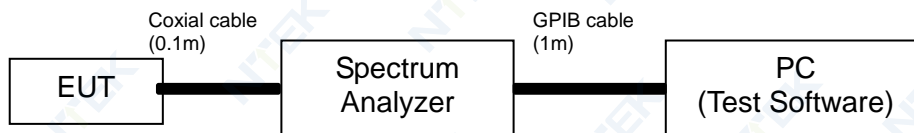

1. For the actual test configuration, please refer to the related Item in this test report (Photographs of the Test Configuration).
2. Testing was performed when the equipment was in a receive-only mode.
3. The measurements were performed when normal hopping was disabled. In this case measurements were performed when operating at the lowest and the highest hopping frequency.
4. The test setup has been constructed as the normal use condition. Controlling software has been activated to set the EUT on specific status.

3.7.5 TEST RESULTS(Radiated measurement)

RX BELOW 1 GHz WORST- CASE DATA(30 MHz ~ 1GHz)

EUT :	Tablet PC	Model Name :	Tab 8 WiFi
Temperature :	26°C	Relative Humidity :	60 %
Pressure :	1012 hPa	Test Voltage :	DC 3.8V
Test Mode :	RX Mode-GFSK(CH19)		

Polar (H/V)	Frequency	Meter Reading	Factor	Emission Level	Limits	Margin	Remark
	(MHz)	(dBm)	(dB)	(dBm)	(dBm)	(dB)	
V	34.207	-83.17	12.98	-70.19	-57	-13.19	peak
V	101.77	-82.68	11.67	-71.01	-57	-14.01	peak
V	221.264	-82.81	18.94	-63.87	-57	-6.87	peak
V	286.918	-80.94	11.65	-69.29	-57	-12.29	peak
V	660.046	-79.39	11.45	-67.94	-57	-10.94	peak
H	46.368	-82.11	18.60	-63.51	-57	-6.51	peak
H	109.677	-81.4	18.11	-63.29	-57	-6.29	peak
H	180.762	-79.2	10.30	-68.90	-57	-11.90	peak
H	441.941	-77.61	15.00	-62.61	-57	-5.61	peak
H	614.443	-83.75	14.63	-69.12	-57	-12.12	peak

Remark:

1. Emission Level = Meter Reading + Factor, Margin= Emission Level - Limit
2. All the modes had been tested, but only the worst data recorded in the report.

RX ABOVE 1 GHz WORST- CASE DATA(1GHz ~ 12.75GHz)

EUT :	Tablet PC	Model Name :	Tab 8 WiFi
Temperature :	24 °C	Relative Humidity	54%
Pressure :	1010 hPa	Test Power :	DC 3.8V
Test Mode :	RX Mode-GFSK(CH19)		

Polar (H/V)	Frequency	Meter Reading	Factor	Emission Level	Limits	Margin	Remark
	(MHz)	(dBm)	(dB)	(dBm)	(dBm)	(dB)	
V	2558.154	-80.74	9.94	-70.80	-47	-23.80	peak
V	4643.728	-83.61	9.82	-73.79	-47	-26.79	peak
V	2915.277	-79.75	10.02	-69.73	-47	-22.73	peak
V	4248.848	-78.18	16.13	-62.05	-47	-15.05	peak
H	2225.416	-84.46	10.11	-74.35	-47	-27.35	peak
H	4057.035	-80.17	10.68	-69.49	-47	-22.49	peak
H	2052.389	-83.48	7.00	-76.48	-47	-29.48	peak
H	4437.338	-84.04	14.56	-69.48	-47	-22.48	peak

1. Emission Level = Meter Reading + Factor, Margin= Emission Level - Limit
 2. All the modes had been tested, but only the worst data recorded in the report.

3.7.6 TEST RESULTS (Conducted measurement)

Test data reference attachment

3.8. RECEIVER BLOCKING

3.8.1 PERFORMANCE CRITERIA

The minimum performance criterion shall be a PER less than or equal to 10 %. The manufacturer may declare alternative performance criteria as long as that is appropriate for the intended use of the equipment (see clause 5.4.1.t)).

3.8.2 LIMITS OF RECEIVER BLOCKING

While maintaining the minimum performance criteria as defined in clause 4.3.2.11.3, the blocking levels at specified frequency offsets shall be equal to or greater than the limits defined for the applicable receiver category provided in table 14, table 15 or table 16.

Table 14: Receiver Blocking parameters for Receiver Category 1 equipment

Wanted signal mean power from companion device (dBm) (see notes 1 and 4)	Blocking signal Frequency (MHz)	Blocking signal power (dBm) (see note 4)	Type of blocking signal
(-133 dBm + 10 × log ₁₀ (OCBW)) or -68 dBm whichever is less (see note 2)	2 380 2 504	-34	CW
(-139 dBm + 10 × log ₁₀ (OCBW)) or -74 dBm whichever is less (see note 3)	2 300 2 330 2 360 2524 2584 2674		

NOTE 1: OCBW is in Hz.

NOTE 2: In case of radiated measurements using a companion device and the level of the wanted signal from the companion device cannot be determined, a relative test may be performed using a wanted signal up to P_{min} + 26 dB where P_{min} is the minimum level of wanted signal required to meet the minimum performance criteria as defined in clause 4.3.1.12.3 in the absence of any blocking signal.

NOTE 3: In case of radiated measurements using a companion device and the level of the wanted signal from the companion device cannot be determined, a relative test may be performed using a wanted signal up to P_{min} + 20 dB where P_{min} is the minimum level of wanted signal required to meet the minimum performance criteria as defined in clause 4.3.1.12.3 in the absence of any blocking signal.

NOTE 4: The level specified is the level at the UUT receiver input assuming a 0 dBi antenna assembly gain. In case of conducted measurements, this level has to be corrected for the (in-band) antenna assembly gain (G). In case of radiated measurements, this level is equivalent to a power flux density (PFD) in front of the UUT antenna with the UUT being configured/positioned as recorded in clause 5.4.3.2.2.

Table 15: Receiver Blocking parameters receiver category 2 equipment

Wanted signal mean power from companion device (dBm) (see notes 1 and 3)	Blocking signal Frequency (MHz)	Blocking signal power (dBm) (see note 3)	Type of blocking signal
(-139 dBm + 10 × log ₁₀ (OCBW) + 10 dB) or (-74 dBm + 10 dB) whichever is less (see note 2)	2 380	-34	CW
	2 504		
	2 300		
	2 584		

NOTE 1: OCBW is in Hz.

NOTE 2: In case of radiated measurements using a companion device and the level of the wanted signal from the companion device cannot be determined, a relative test may be performed using a wanted signal up to P_{min} + 26 dB where P_{min} is the minimum level of wanted signal required to meet the minimum performance criteria as defined in clause 4.3.1.12.3 in the absence of any blocking signal.

NOTE 3: The level specified is the level at the UUT receiver input assuming a 0 dBi antenna assembly gain. In case of conducted measurements, this level has to be corrected for the (in-band) antenna assembly gain (G). In case of radiated measurements, this level is equivalent to a power flux density (PFD) in front of the UUT antenna with the UUT being configured/positioned as recorded in clause 5.4.3.2.2.

Table 16: Receiver Blocking parameters receiver category 3 equipment

Wanted signal mean power from companion device (dBm)	Blocking signal Frequency (MHz)	Blocking signal power (dBm) (see note 2)	Type of blocking signal
(-139 dBm + 10 × log ₁₀ (OCBW) + 20 dB) or (-74 dBm + 20 dB) whichever is less (see note 2)	2 380	-34	CW
	2 504		
	2 300		
	2 584		

NOTE 1: OCBW is in Hz.

NOTE 2: In case of radiated measurements using a companion device and the level of the wanted signal from the companion device cannot be determined, a relative the test may be performed using a wanted signal up to P_{min} + 30 dB where P_{min} is the minimum level of wanted signal required to meet the minimum performance criteria as defined in clause 4.3.1.12.3 in the absence of any blocking signal.

NOTE 3: The level specified is the level at the UUT receiver input assuming a 0 dBi antenna assembly gain. In case of conducted measurements, this level has to be corrected for the (in-band) antenna assembly gain (G). In case of radiated measurements, this level is equivalent to a power flux density (PFD) in front of the UUT antenna with the UUT being configured/positioned as recorded in clause 5.4.3.2.2.

3.8.3 TEST PROCEDURE

Refer to chapter 5.4.11.2 of ETSI EN 300 328 V2.2.2 (2019-07)

Measurement	
<input checked="" type="checkbox"/> Conducted measurement	<input type="checkbox"/> Radiated measurement

3.8.4 DEVIATION FROM TEST STANDARD

No deviation

3.8.5 TEST SETUP

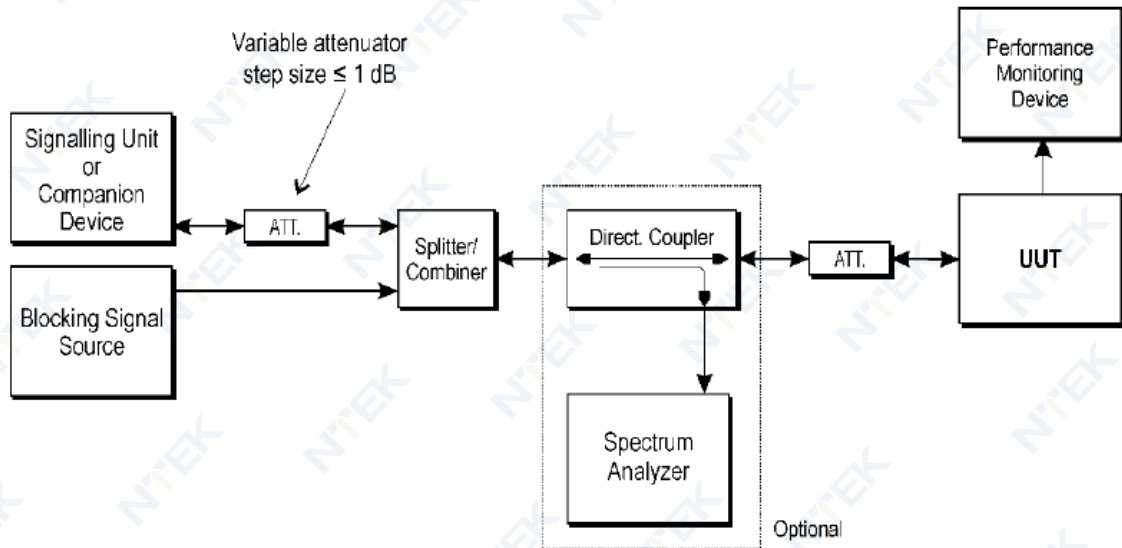

3.8.6 TEST RESULTS

EUT :	Tablet PC	Model Name :	Tab 8 WiFi
Temperature :	24 °C	Relative Humidity	54%
Pressure :	1010 hPa	Test Power :	DC 3.8V
Test Mode :	GFSK-RX Mode (CH00/CH39)-1M		

CH00:

receiver category 3

Wanted signal mean power from companion device (dBm) <small>Note(1)</small>	Blocking signal Frequency (MHz)	Blocking signal power (dBm)	PER %	PER Limit %
-58.88	2 380	-34	0.79%	≤10%
	2 504		0.50%	
	2 300		0.15%	≤10%
	2 584		0.36%	

CH39:

receiver category 3

Wanted signal mean power from companion device (dBm) <small>Note(1)</small>	Blocking signal Frequency (MHz)	Blocking signal power (dBm)	PER %	PER Limit %
-58.87	2 380	-34	0.76%	≤10%
	2 504		0.29%	
	2 300		0.76%	≤10%
	2 584		0.61%	

Note: (1) The above results were obtained from laboratory tests.

EUT :	Tablet PC	Model Name :	Tab 8 WiFi
Temperature :	24 °C	Relative Humidity	54%
Pressure :	1010 hPa	Test Power :	DC 3.8V
Test Mode :	GFSK-RX Mode (CH00/CH39)-2M		

CH00:

receiver category 3

Wanted signal mean power from companion device (dBm) <small>Note(1)</small>	Blocking signal Frequency (MHz)	Blocking signal power (dBm)	PER %	PER Limit %
-55.83	2 380	-34	0.21%	≤10%
	2 504		0.44%	
	2 300		0.71%	≤10%
	2 584		0.46%	

CH39:

receiver category 3

Wanted signal mean power from companion device (dBm) <small>Note(1)</small>	Blocking signal Frequency (MHz)	Blocking signal power (dBm)	PER %	PER Limit %
-55.83	2 380	-34	0.31%	≤10%
	2 504		0.15%	
	2 300		0.40%	≤10%
	2 584		0.49%	

Note: (1) The above results were obtained from laboratory tests.

4. TEST RESULTS

1M:

4.1.1 RF Output Power

Condition	Mode	Frequency (MHz)	Max Burst RMS Power (dBm)	Burst Number	Max EIRP (dBm)	Limit (dBm)	Verdict
NVNT	BLE-1M	2402	-5.43	160	-2.43	20	Pass
NVNT	BLE-1M	2440	-3.93	161	-0.93	20	Pass
NVNT	BLE-1M	2480	-4.45	161	-1.45	20	Pass
NVLT	BLE-1M	2402	-6.28	161	-3.28	20	Pass
NVLT	BLE-1M	2440	-4.71	161	-1.71	20	Pass
NVLT	BLE-1M	2480	-4.99	161	-1.99	20	Pass
NVHT	BLE-1M	2402	-6.34	161	-3.34	20	Pass
NVHT	BLE-1M	2440	-4.61	161	-1.61	20	Pass
NVHT	BLE-1M	2480	-4.79	161	-1.79	20	Pass

Test Graphs

Power NVNT BLE 1M 2402MHz Ant1

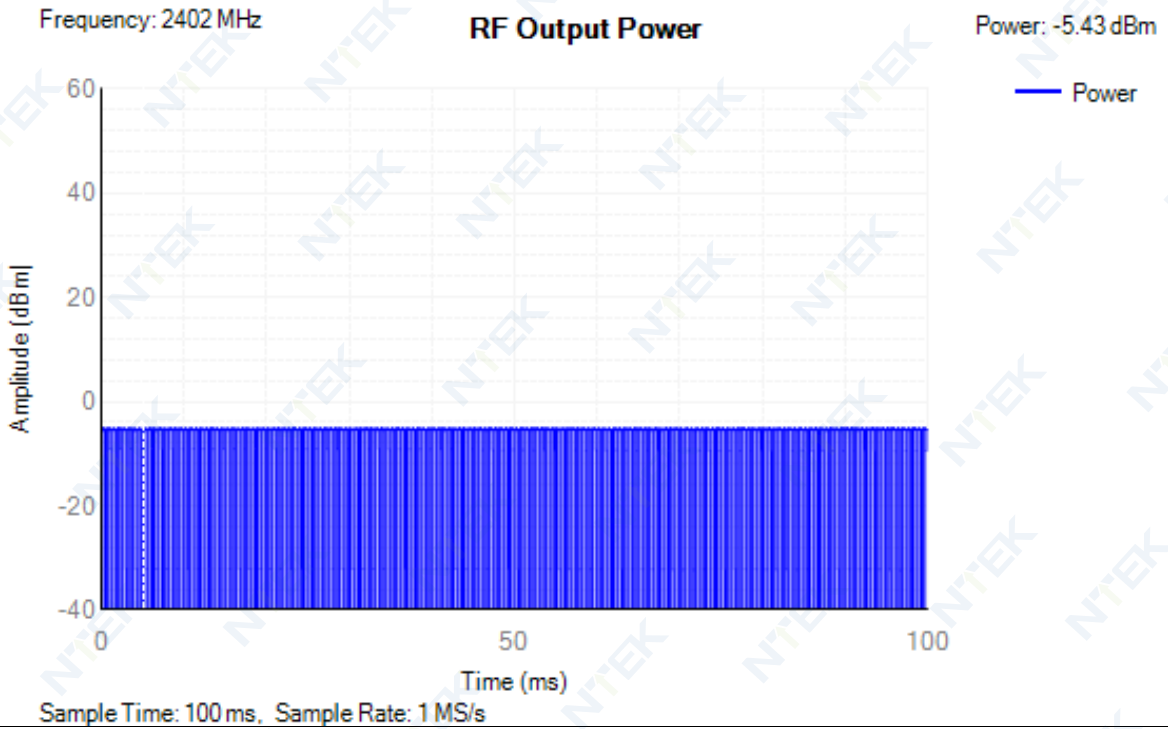

Power NVNT BLE 1M 2440MHz Ant1

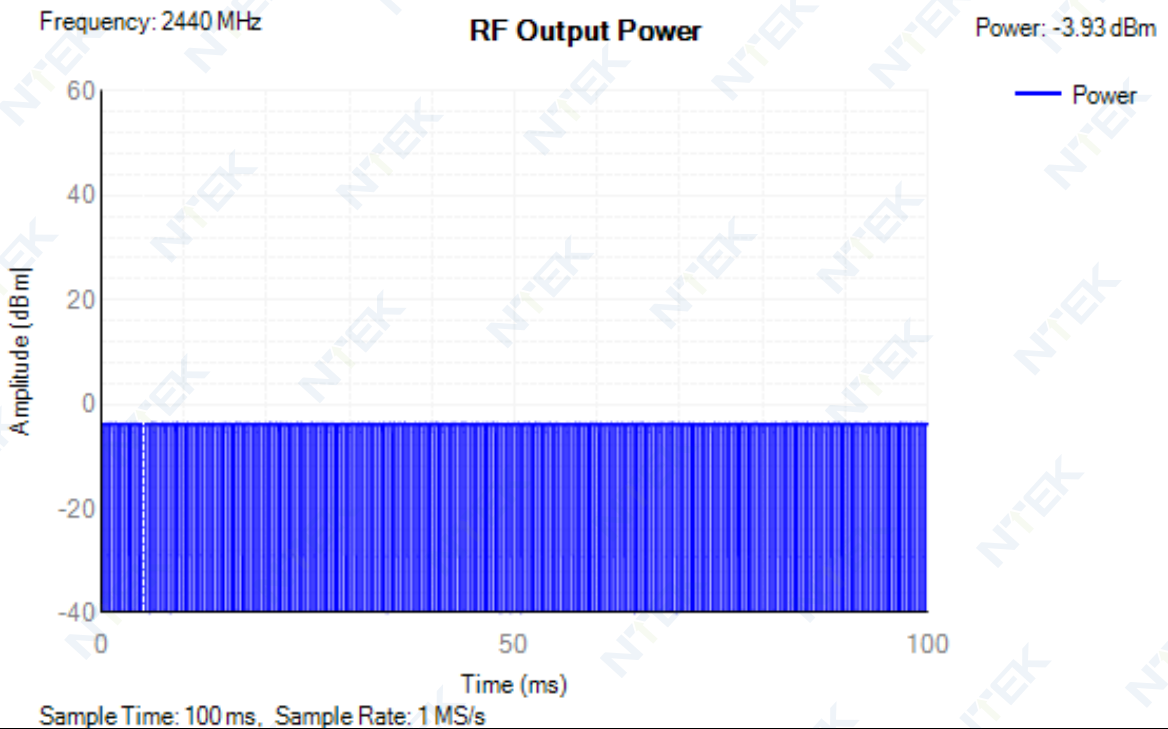

Power NVNT BLE 1M 2480MHz Ant1

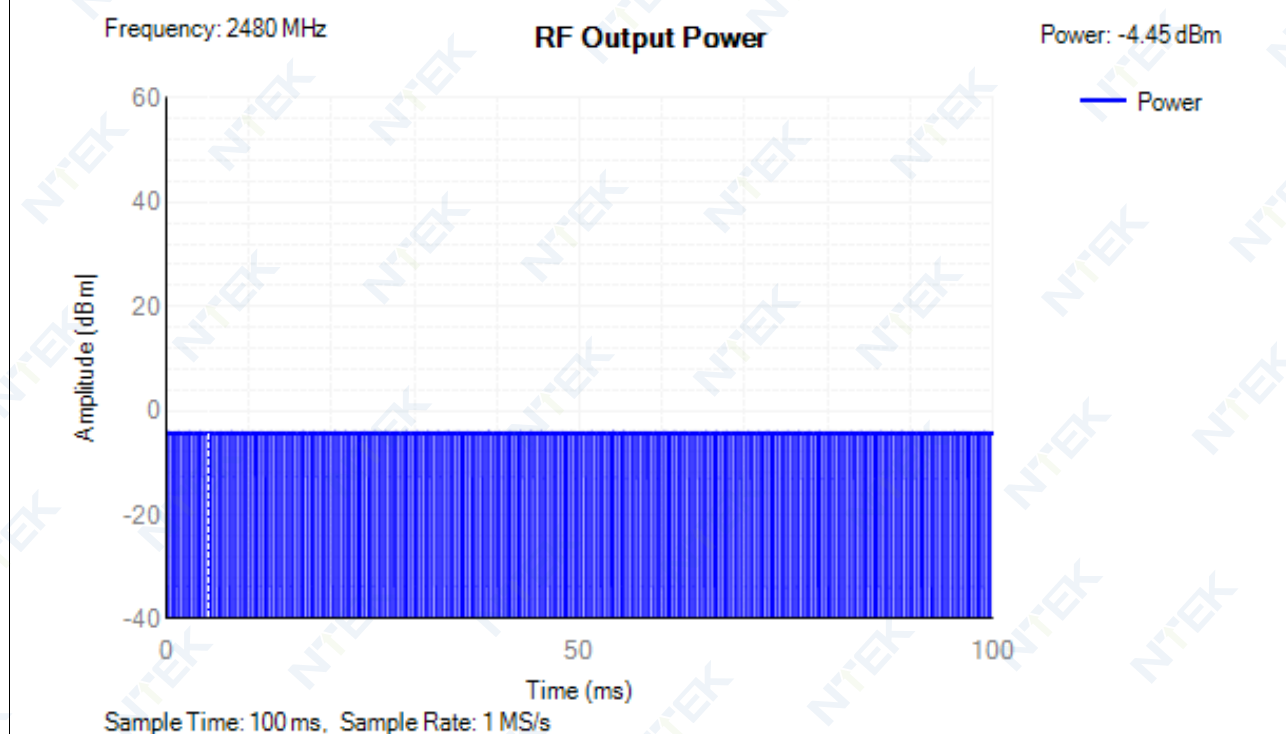

4.1.2 Power Spectral Density

Condition	Mode	Frequency (MHz)	Antenna	Max PSD (dBm/MHz)	Limit (dBm/MHz)	Verdict
NVNT	BLE 1M	2402	Ant1	-1.94	10	Pass
NVNT	BLE 1M	2440	Ant1	-0.44	10	Pass
NVNT	BLE 1M	2480	Ant1	-0.96	10	Pass

Test Graphs

PSD NVNT BLE 1M 2402MHz Ant1

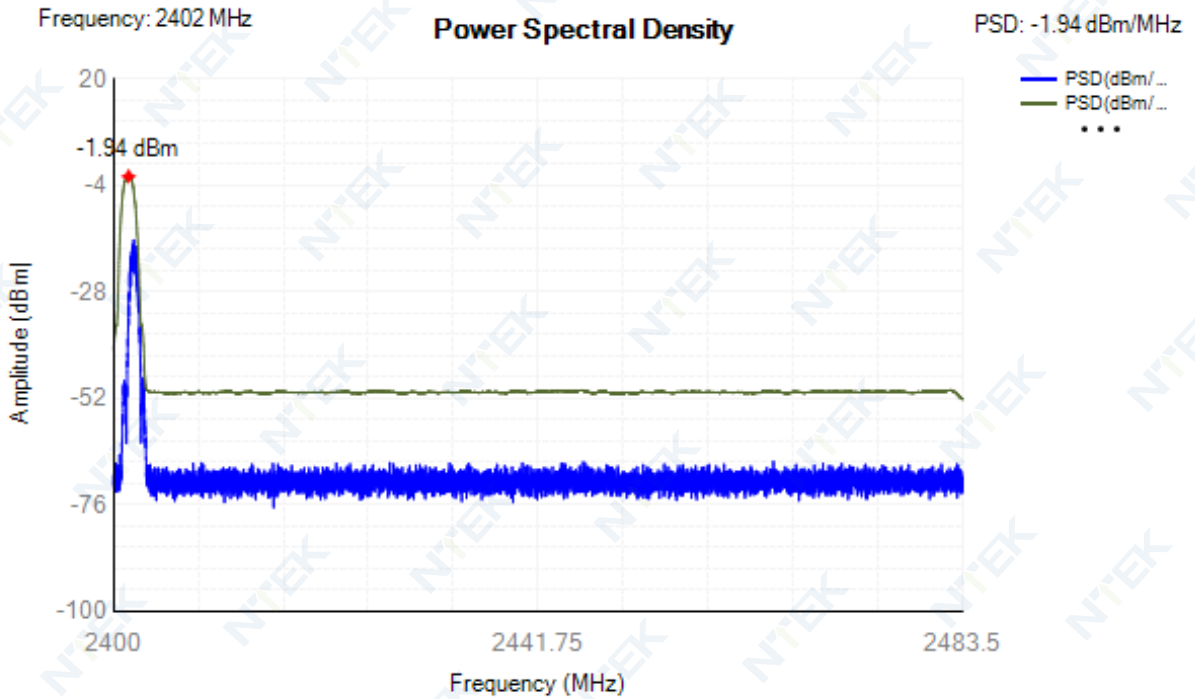

PSD NVNT BLE 1M 2440MHz Ant1

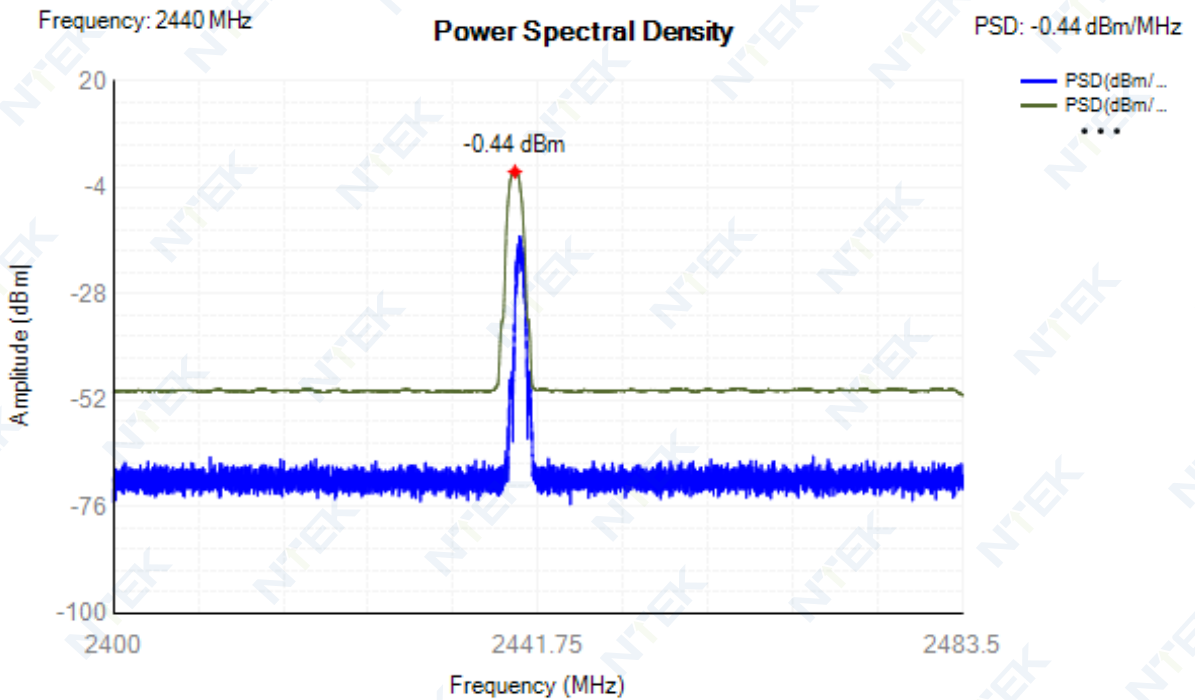

PSD NVNT BLE 1M 2480MHz Ant1

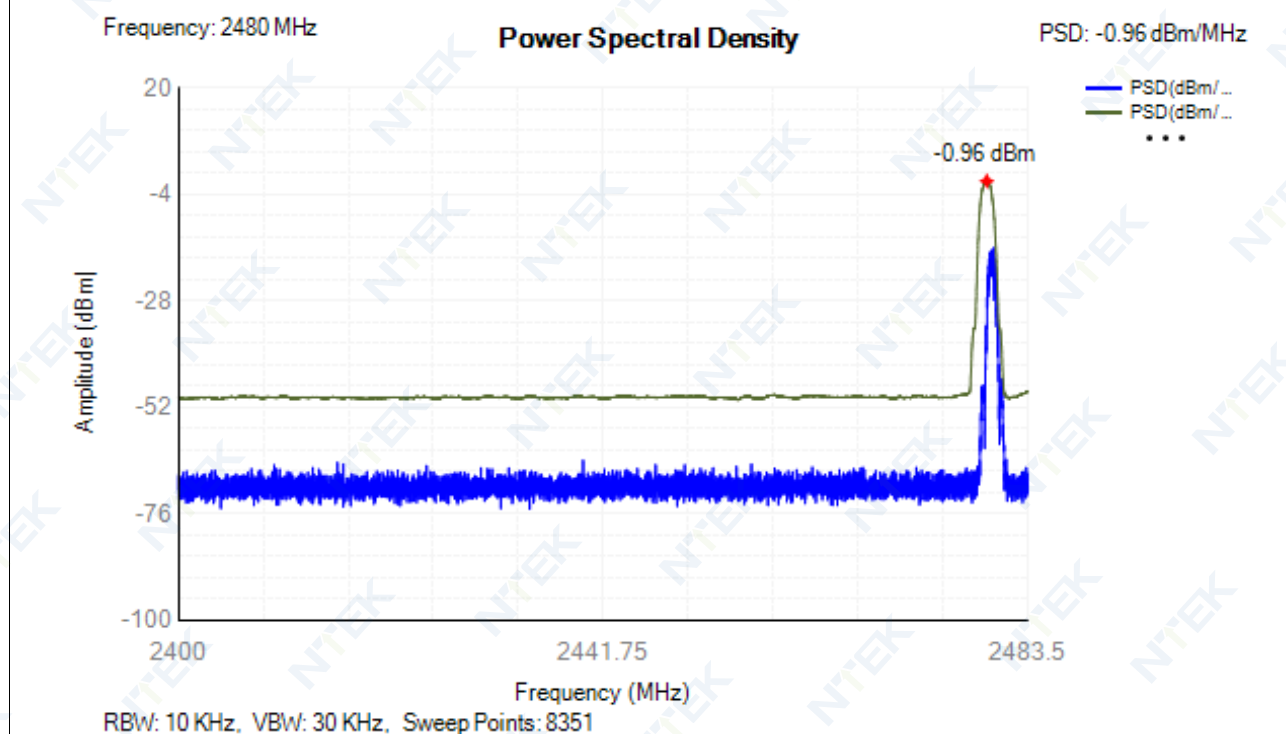

4.1.3 Occupied Channel Bandwidth

Condition	Mode	Frequency (MHz)	Antenna	Center Frequency (MHz)	OBW (MHz)	Lower Edge (MHz)	Upper Edge (MHz)	Limit OBW (MHz)	Verdict
NVNT	BLE 1M	2402	Ant1	2402.009	1.029	2401.495	2402.523	2400 - 2483.5MHz	Pass
NVNT	BLE 1M	2440	Ant1	2440.008	1.031	2439.493	2440.523	2400 - 2483.5MHz	Pass
NVNT	BLE 1M	2480	Ant1	2480.008	1.031	2479.493	2480.523	2400 - 2483.5MHz	Pass

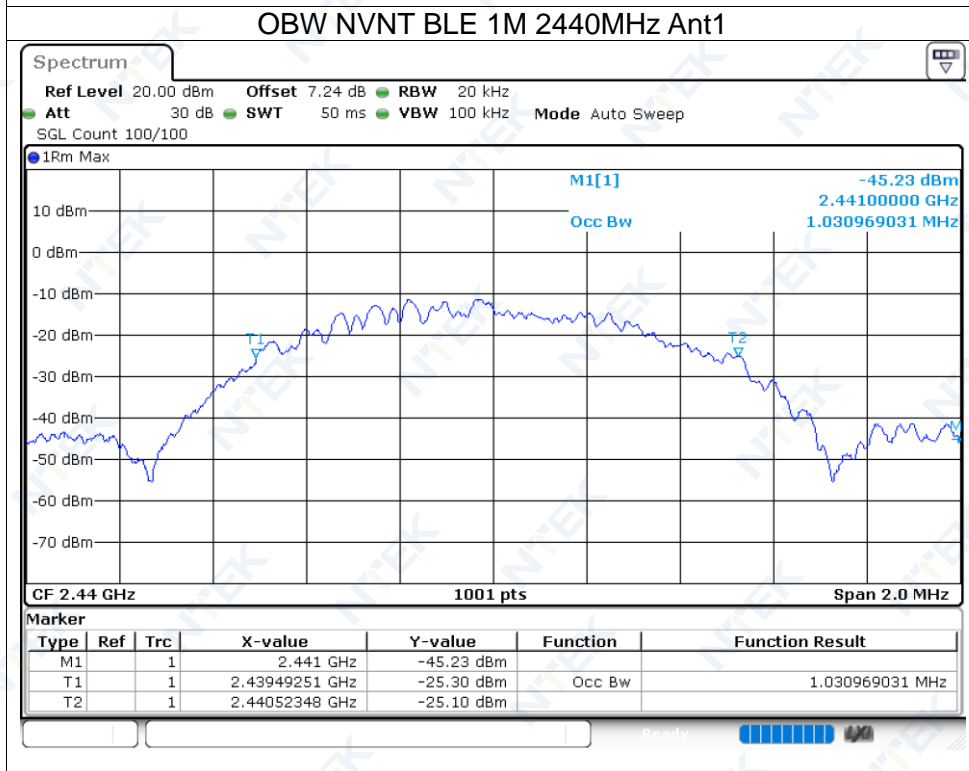
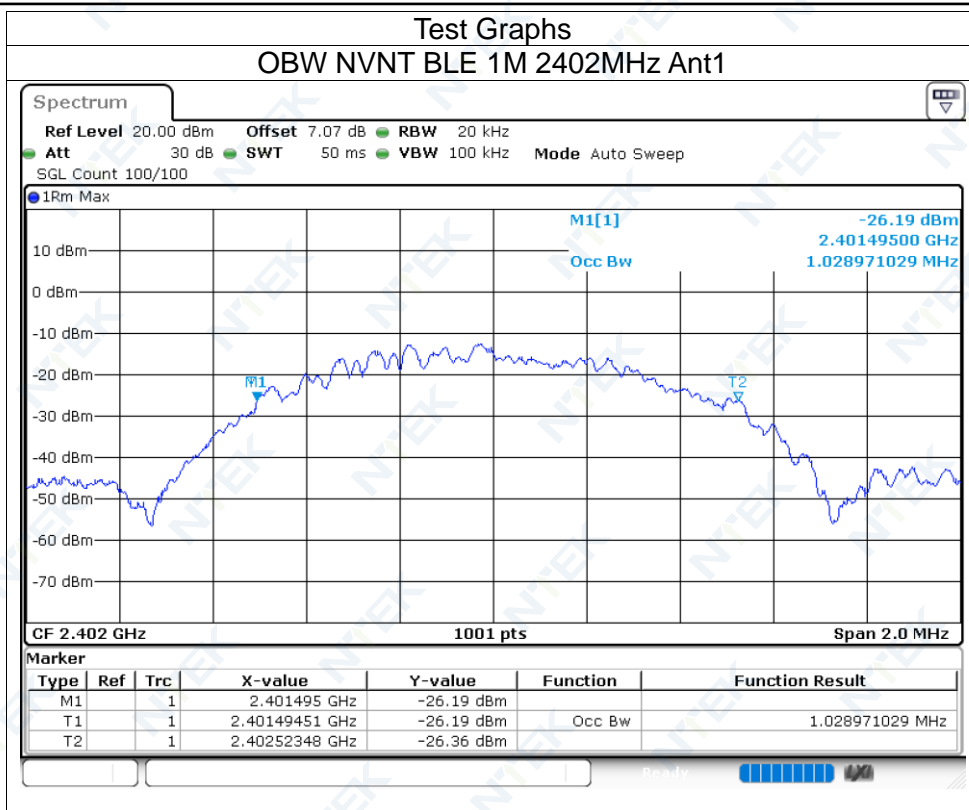

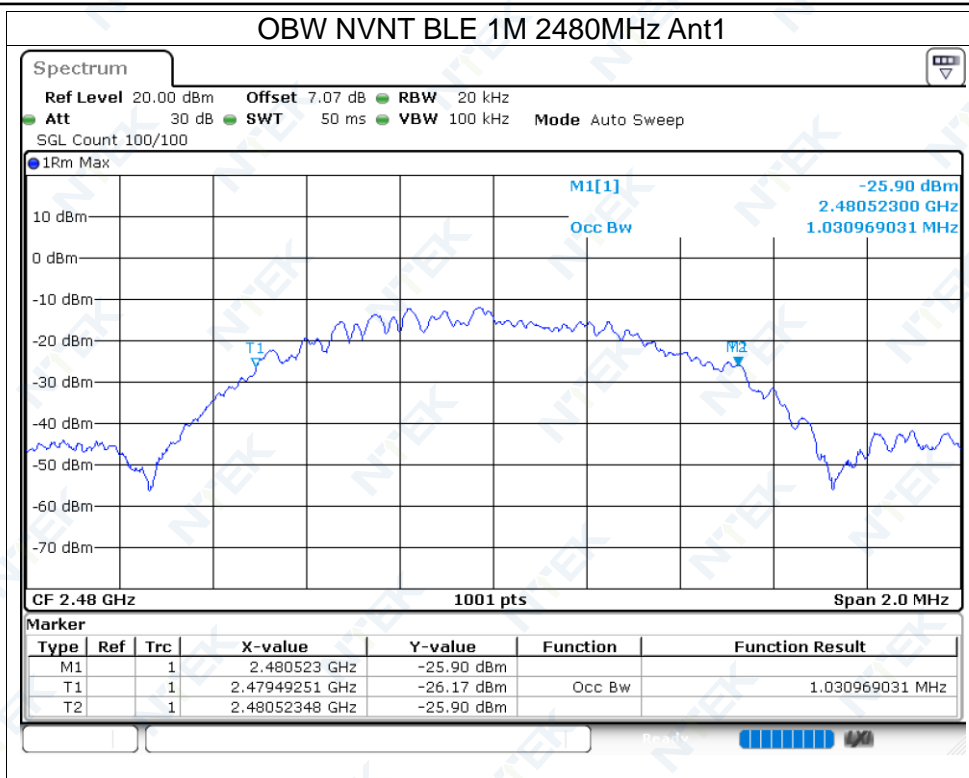

4.1.4 Transmitter unwanted emissions in the out-of-band domain

Condition	Mode	Frequency (MHz)	Antenna	OOB Frequency (MHz)	Level (dBm/MHz)	Limit (dBm/MHz)	Verdict
NVNT	BLE 1M	2402	Ant1	2399.5	-42.4	-10	Pass
NVNT	BLE 1M	2402	Ant1	2399.471	-41.97	-10	Pass
NVNT	BLE 1M	2402	Ant1	2398.471	-41.84	-20	Pass
NVNT	BLE 1M	2402	Ant1	2398.442	-41.83	-20	Pass
NVNT	BLE 1M	2402	Ant1	2484	-41.69	-10	Pass
NVNT	BLE 1M	2402	Ant1	2485	-41.7	-20	Pass
NVNT	BLE 1M	2480	Ant1	2399.5	-52.24	-10	Pass
NVNT	BLE 1M	2480	Ant1	2398.5	-51.91	-20	Pass
NVNT	BLE 1M	2480	Ant1	2484	-51.36	-10	Pass
NVNT	BLE 1M	2480	Ant1	2484.031	-51.33	-10	Pass
NVNT	BLE 1M	2480	Ant1	2485.031	-51.41	-20	Pass
NVNT	BLE 1M	2480	Ant1	2485.062	-51.39	-20	Pass

Test Graphs

Tx. Emissions OOB NVNT BLE 1M 2402MHz Ant1

Frequency: 2402 MHz

Transmitter unwanted emissions in the out-of-band domain

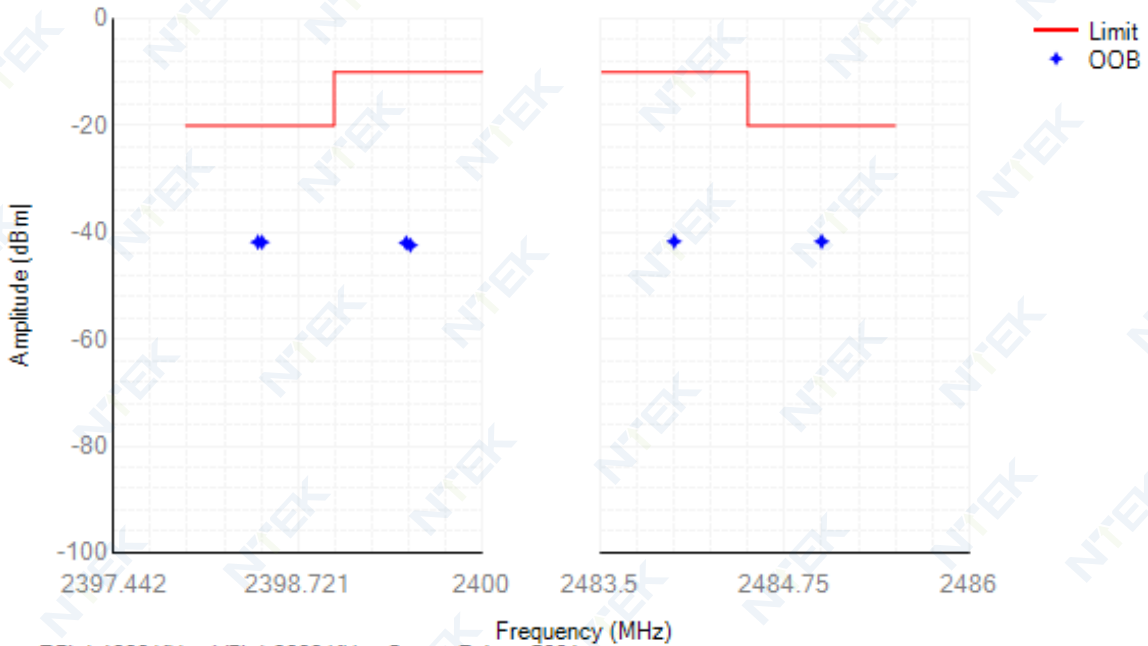

Tx. Emissions OOB NVNT BLE 1M 2480MHz Ant1

Frequency: 2480 MHz

Transmitter unwanted emissions in the out-of-band domain

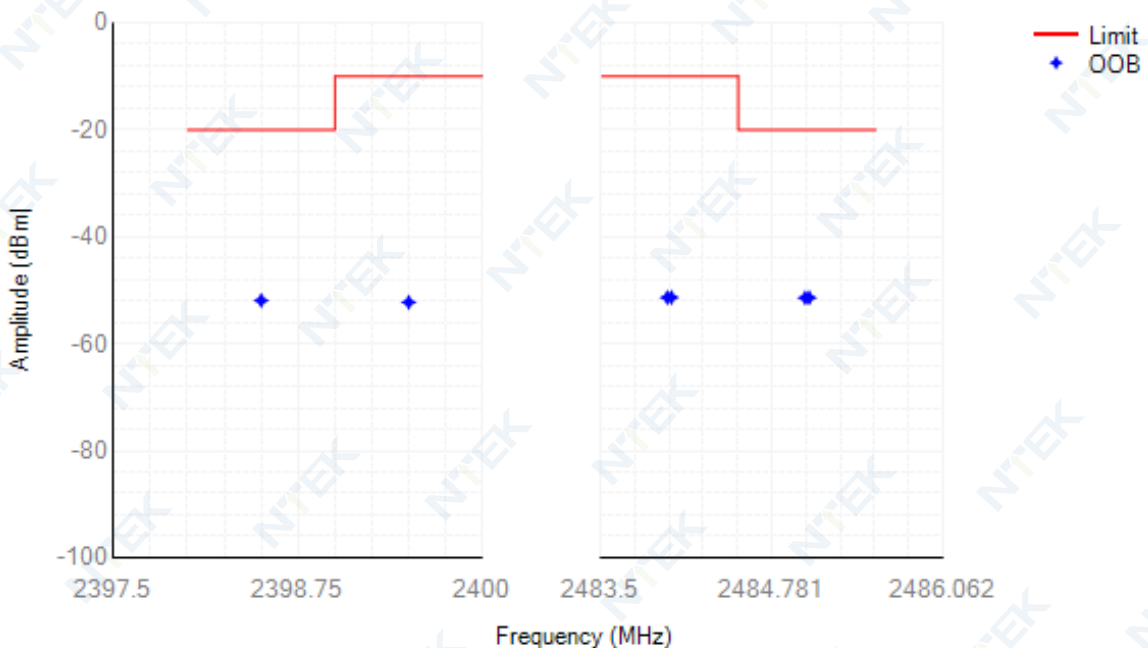

4.1.5 Transmitter unwanted emissions in the spurious domain

Condition	Mode	Frequency (MHz)	Antenna	Range (MHz)	Spur Freq (MHz)	Peak (dBm)	RMS (dBm)	Limit (dBm)	Verdict
NVNT	BLE 1M	2402	Ant1	30 -47	42.10	-75.50	NA	-36	Pass
NVNT	BLE 1M	2402	Ant1	47 -74	73.70	-75.05	NA	-54	Pass
NVNT	BLE 1M	2402	Ant1	74 -87.5	76.80	-76.50	NA	-36	Pass
NVNT	BLE 1M	2402	Ant1	87.5 -118	116.90	-74.88	NA	-54	Pass
NVNT	BLE 1M	2402	Ant1	118 -174	167.90	-74.70	NA	-36	Pass
NVNT	BLE 1M	2402	Ant1	174 -230	175.85	-75.38	NA	-54	Pass
NVNT	BLE 1M	2402	Ant1	230 -470	385.40	-74.42	NA	-36	Pass
NVNT	BLE 1M	2402	Ant1	470 -694	629.65	-74.36	NA	-54	Pass
NVNT	BLE 1M	2402	Ant1	694 -1000	919.70	-72.72	NA	-36	Pass
NVNT	BLE 1M	2402	Ant1	1000 -2398	2345.50	-52.95	NA	-30	Pass
NVNT	BLE 1M	2402	Ant1	2485.5 -12750	6947.50	-44.62	NA	-30	Pass
NVNT	BLE 1M	2440	Ant1	30 -47	40.75	-75.26	NA	-36	Pass
NVNT	BLE 1M	2440	Ant1	47 -74	57.95	-75.33	NA	-54	Pass
NVNT	BLE 1M	2440	Ant1	74 -87.5	83.90	-76.40	NA	-36	Pass
NVNT	BLE 1M	2440	Ant1	87.5 -118	113.00	-75.22	NA	-54	Pass
NVNT	BLE 1M	2440	Ant1	118 -174	172.85	-74.49	NA	-36	Pass
NVNT	BLE 1M	2440	Ant1	174 -230	229.05	-74.77	NA	-54	Pass
NVNT	BLE 1M	2440	Ant1	230 -470	367.00	-74.38	NA	-36	Pass
NVNT	BLE 1M	2440	Ant1	470 -694	676.35	-74.61	NA	-54	Pass
NVNT	BLE 1M	2440	Ant1	694 -1000	785.40	-73.79	NA	-36	Pass
NVNT	BLE 1M	2440	Ant1	1000 -2398	2193.50	-52.78	NA	-30	Pass
NVNT	BLE 1M	2440	Ant1	2485.5 -12750	6979.50	-44.44	NA	-30	Pass
NVNT	BLE 1M	2480	Ant1	30 -47	42.60	-75.93	NA	-36	Pass
NVNT	BLE 1M	2480	Ant1	47 -74	58.15	-76.00	NA	-54	Pass
NVNT	BLE 1M	2480	Ant1	74 -87.5	82.05	-76.42	NA	-36	Pass
NVNT	BLE 1M	2480	Ant1	87.5 -118	91.45	-75.63	NA	-54	Pass
NVNT	BLE 1M	2480	Ant1	118 -174	156.55	-75.24	NA	-36	Pass
NVNT	BLE 1M	2480	Ant1	174 -230	205.70	-74.91	NA	-54	Pass
NVNT	BLE 1M	2480	Ant1	230 -470	292.95	-74.42	NA	-36	Pass
NVNT	BLE 1M	2480	Ant1	470 -694	614.80	-74.24	NA	-54	Pass
NVNT	BLE 1M	2480	Ant1	694 -1000	900.55	-73.64	NA	-36	Pass
NVNT	BLE 1M	2480	Ant1	1000 -2398	2333.50	-53.24	NA	-30	Pass
NVNT	BLE 1M	2480	Ant1	2485.5 -12750	6947.50	-43.51	NA	-30	Pass

Test Graphs

Tx. Spurious NVNT BLE 1M 2402MHz Ant1

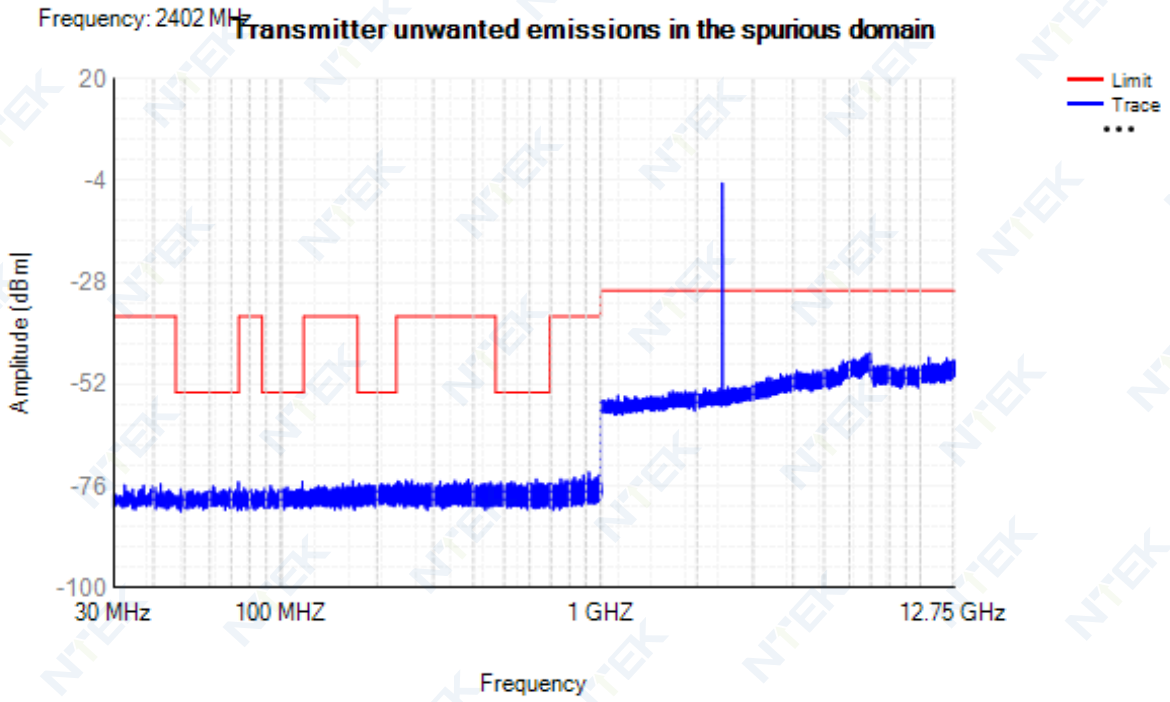

Tx. Spurious NVNT BLE 1M 2440MHz Ant1

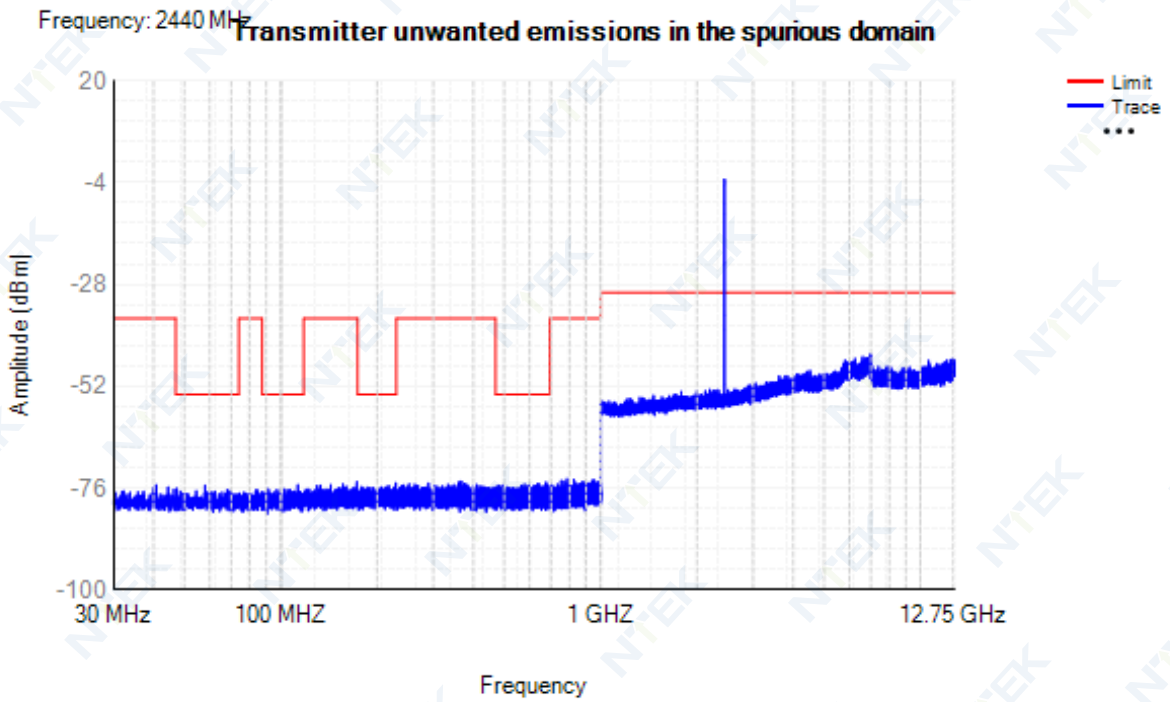

Tx. Spurious NVNT BLE 1M 2480MHz Ant1

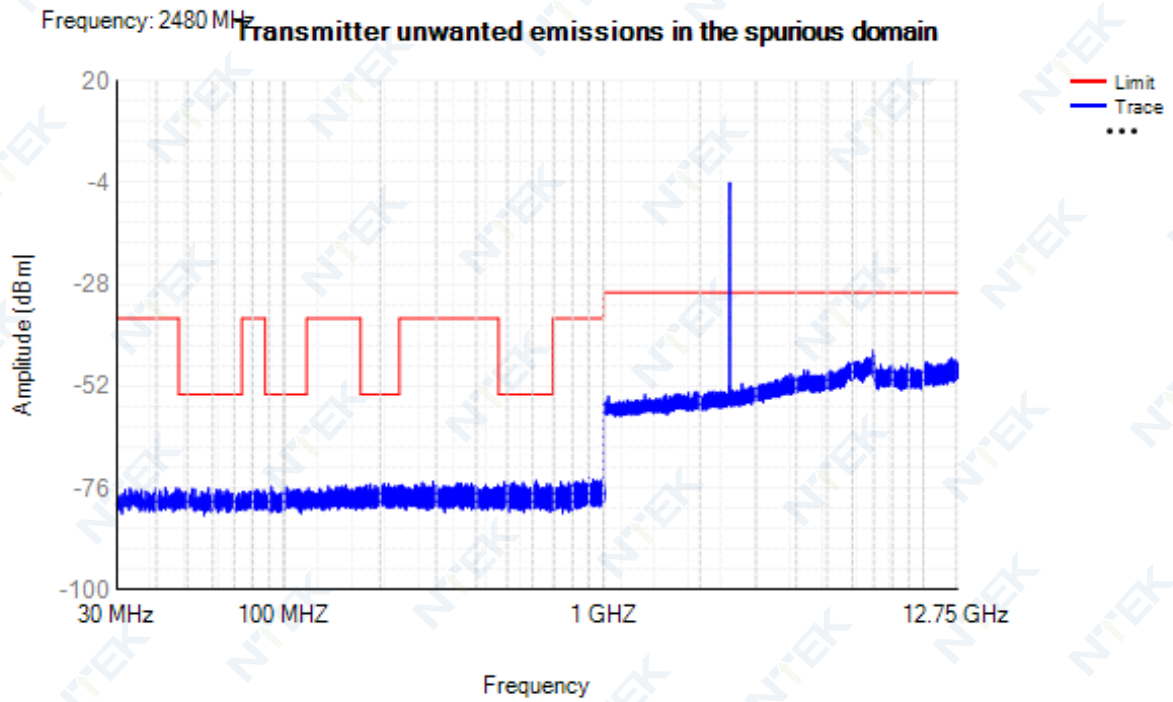

4.1.6 Receiver spurious emissions

Condition	Mode	Frequency (MHz)	Antenna	Range (MHz)	Spur Freq (MHz)	Peak (dBm)	RMS (dBm)	Limit (dBm)	Verdict
NVNT	BLE 1M	2402	Ant1	30 -1000	917.45	-73.38	NA	-57	Pass
NVNT	BLE 1M	2402	Ant1	1000 -12750	6882.5	-54.04	NA	-47	Pass
NVNT	BLE 1M	2440	Ant1	30 -1000	938.75	-73.48	NA	-57	Pass
NVNT	BLE 1M	2440	Ant1	1000 -12750	6995	-55.06	NA	-47	Pass
NVNT	BLE 1M	2480	Ant1	30 -1000	956.85	-73.64	NA	-57	Pass
NVNT	BLE 1M	2480	Ant1	1000 -12750	6553	-55.20	NA	-47	Pass

Test Graphs

Rx. Spurious NVNT BLE 1M 2402MHz Ant1

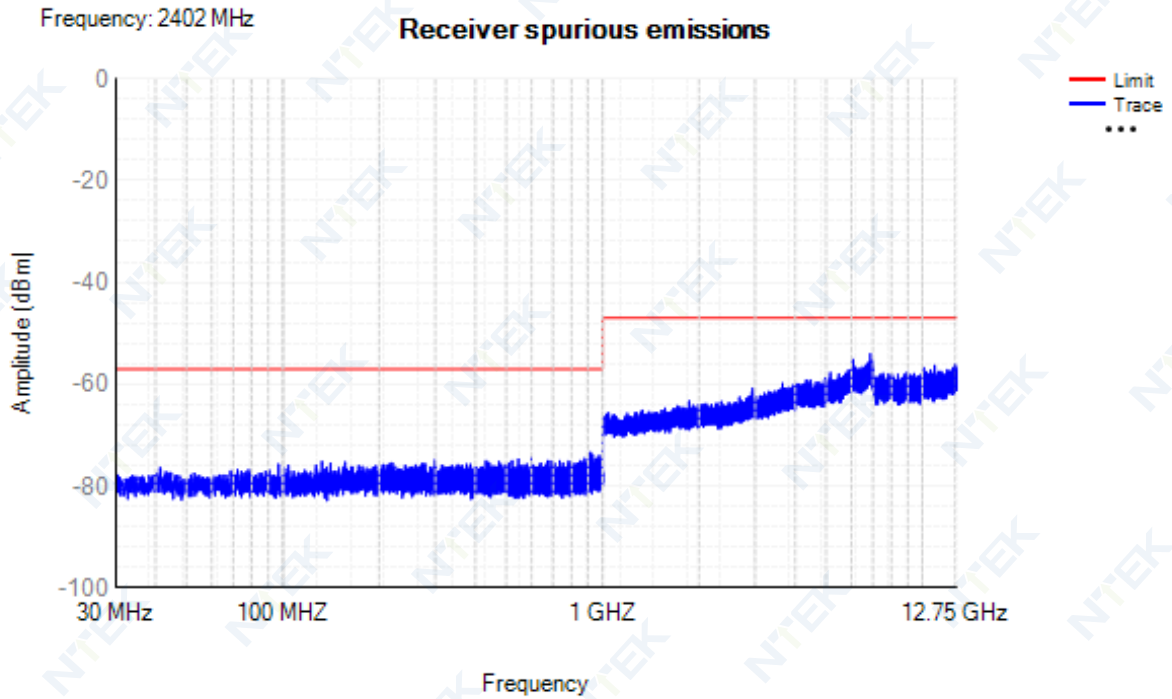

Rx. Spurious NVNT BLE 1M 2440MHz Ant1

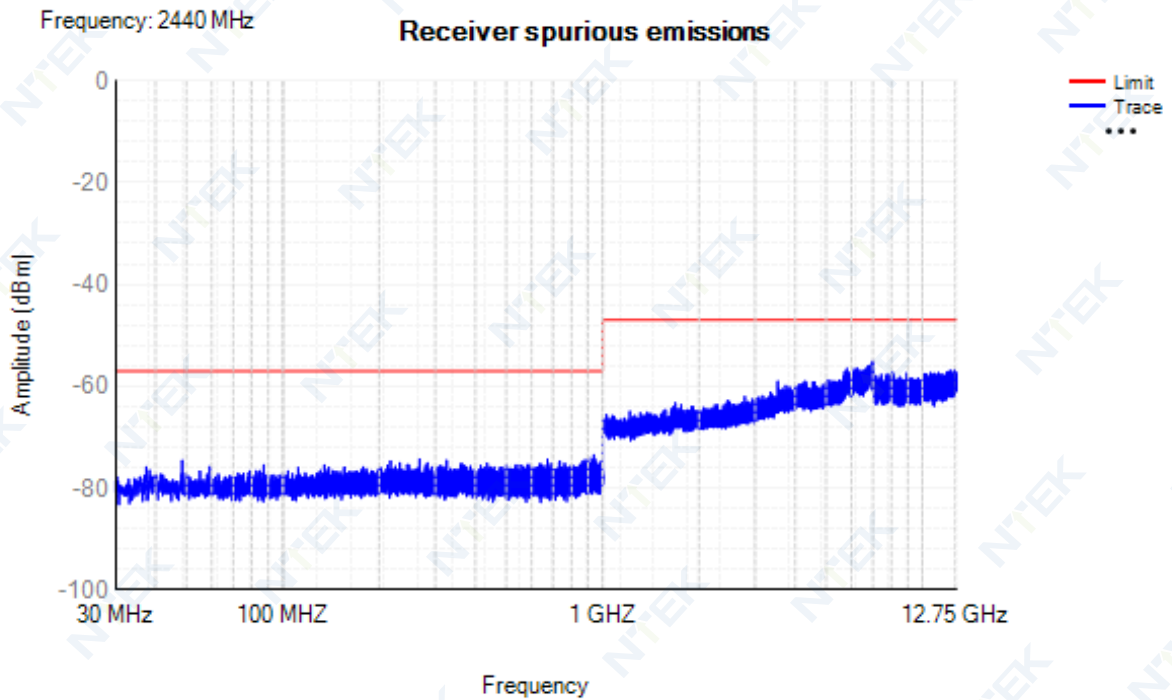

Rx. Spurious NVNT BLE 1M 2480MHz Ant1

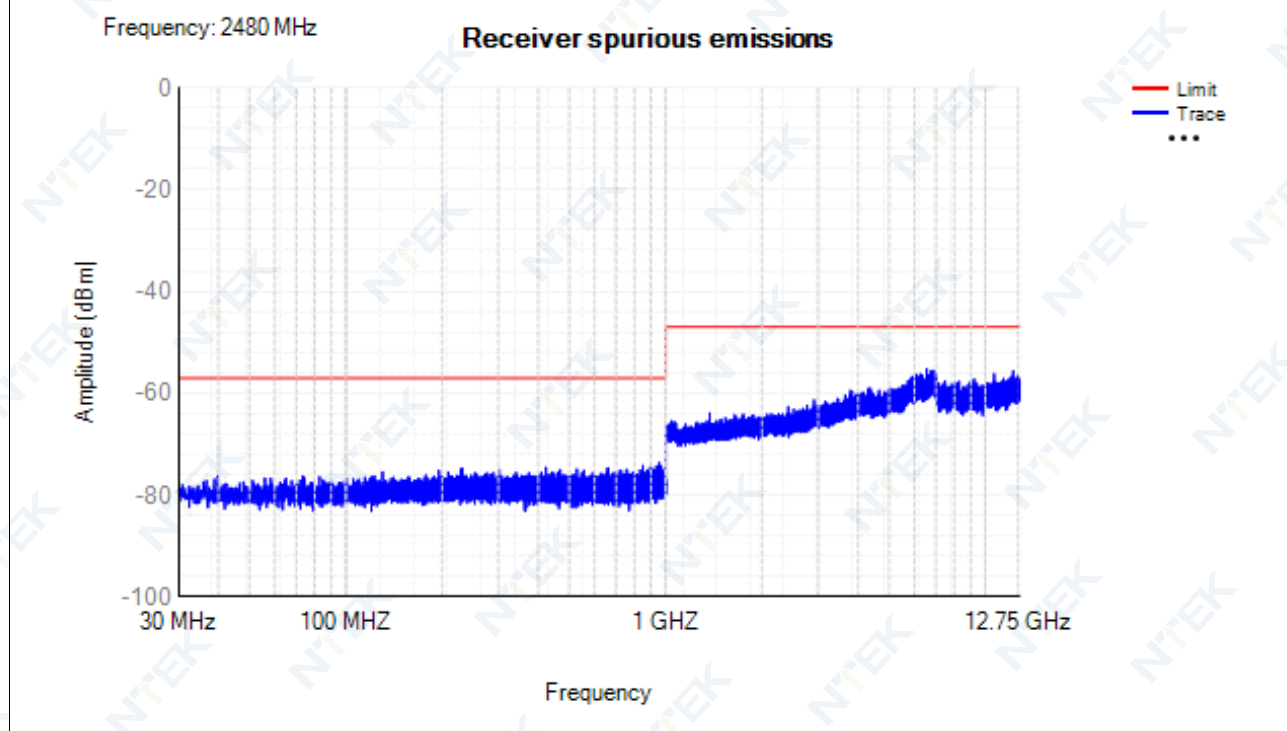

2M:

4.2.1 RF Output Power

Condition	Mode	Frequency (MHz)	Max Burst RMS Power (dBm)	Burst Number	Max EIRP (dBm)	Limit (dBm)	Verdict
NVNT	BLE-2M	2402	-5.5	161	-2.5	20	Pass
NVNT	BLE-2M	2440	-4.07	160	-1.07	20	Pass
NVNT	BLE-2M	2480	-4.53	161	-1.53	20	Pass
NVLT	BLE-2M	2402	-6.35	161	-3.35	20	Pass
NVLT	BLE-2M	2440	-4.85	161	-1.85	20	Pass
NVLT	BLE-2M	2480	-5.07	161	-2.07	20	Pass
NVHT	BLE-2M	2402	-6.41	161	-3.41	20	Pass
NVHT	BLE-2M	2440	-4.75	161	-1.75	20	Pass
NVHT	BLE-2M	2480	-4.87	161	-1.87	20	Pass

Test Graphs

Power NVNT BLE 2M 2402MHz Ant1

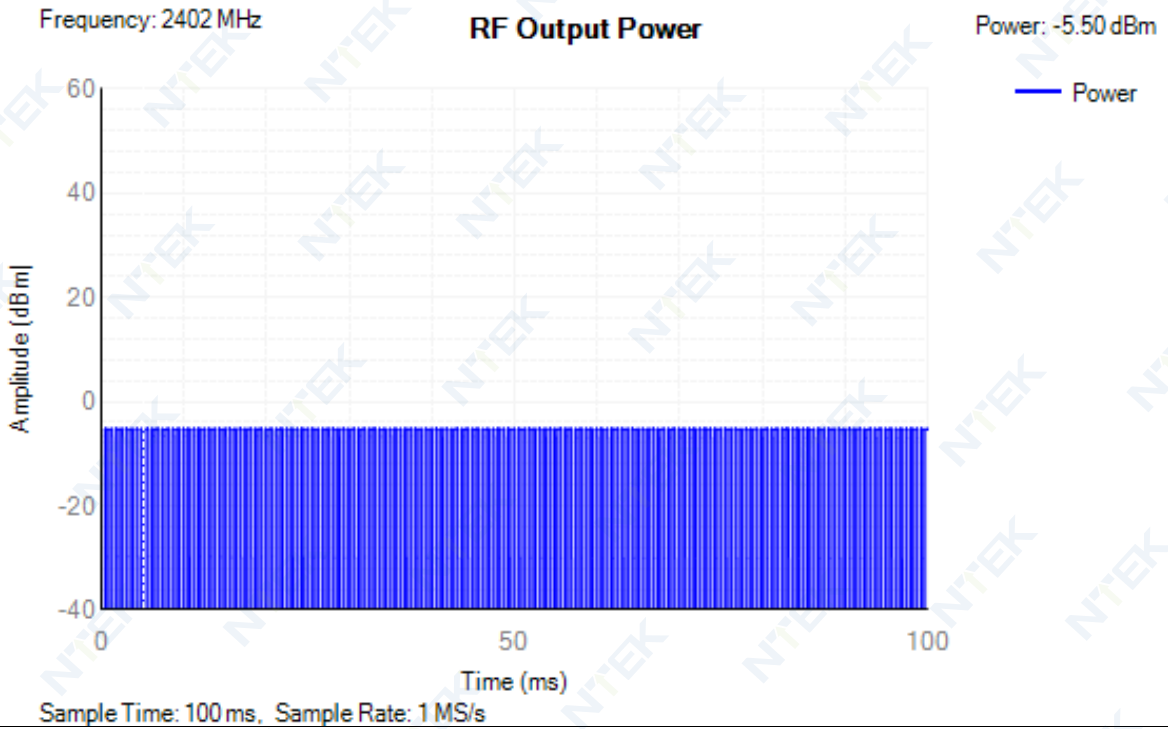

Power NVNT BLE 2M 2440MHz Ant1

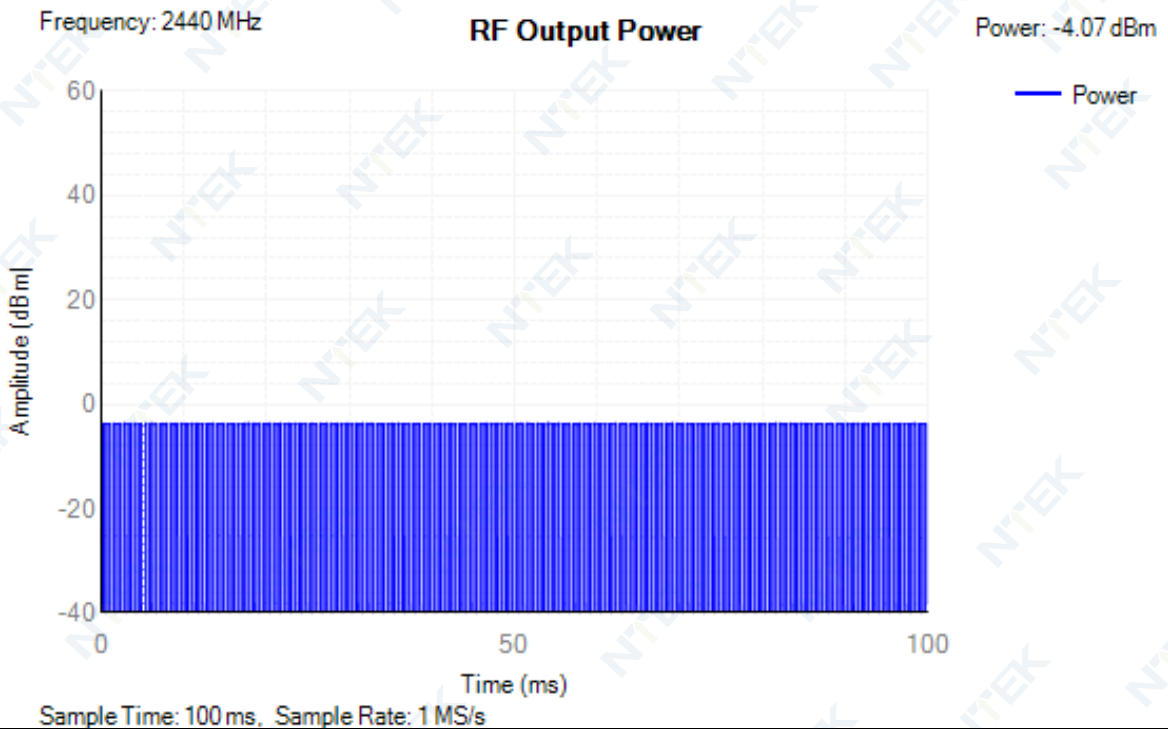

Power NVNT BLE 2M 2480MHz Ant1

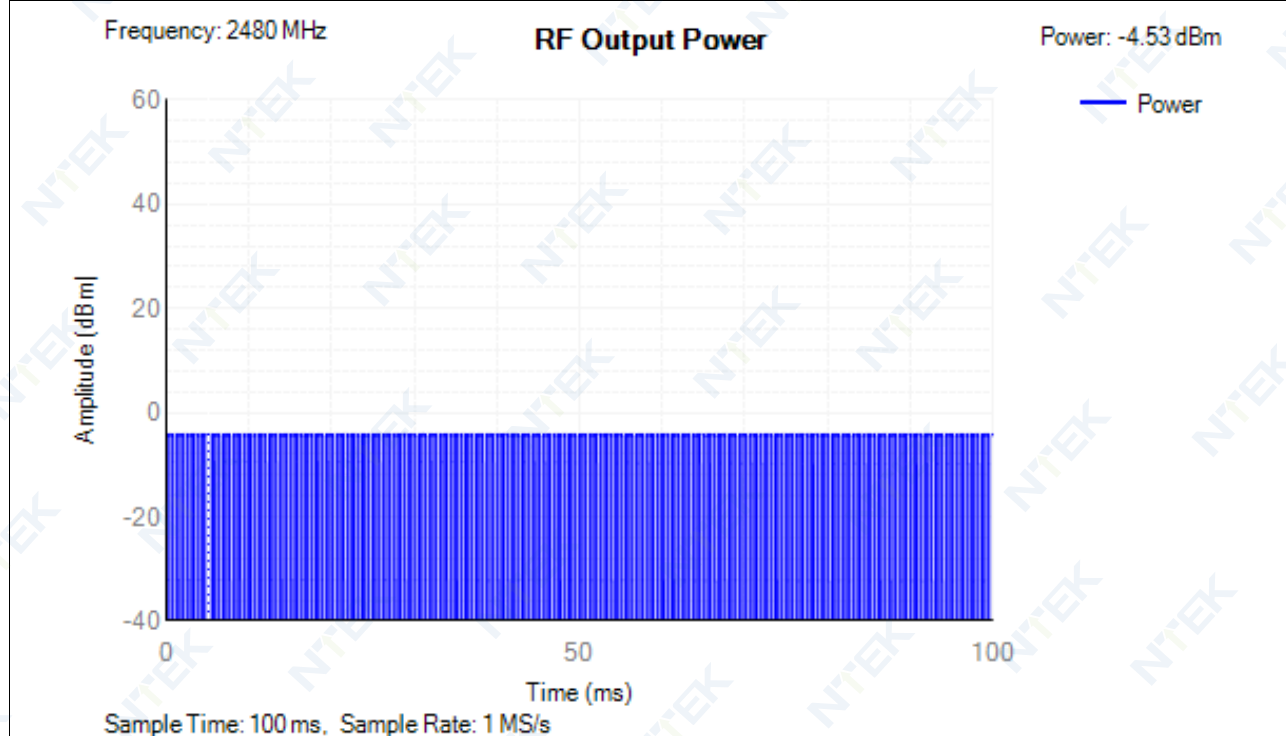

4.2.2 Power Spectral Density

Condition	Mode	Frequency (MHz)	Antenna	Max PSD (dBm/MHz)	Limit (dBm/MHz)	Verdict
NVNT	BLE 2M	2402	Ant1	-3.23	10	Pass
NVNT	BLE 2M	2440	Ant1	-1.77	10	Pass
NVNT	BLE 2M	2480	Ant1	-2.26	10	Pass

Test Graphs

PSD NVNT BLE 2M 2402MHz Ant1

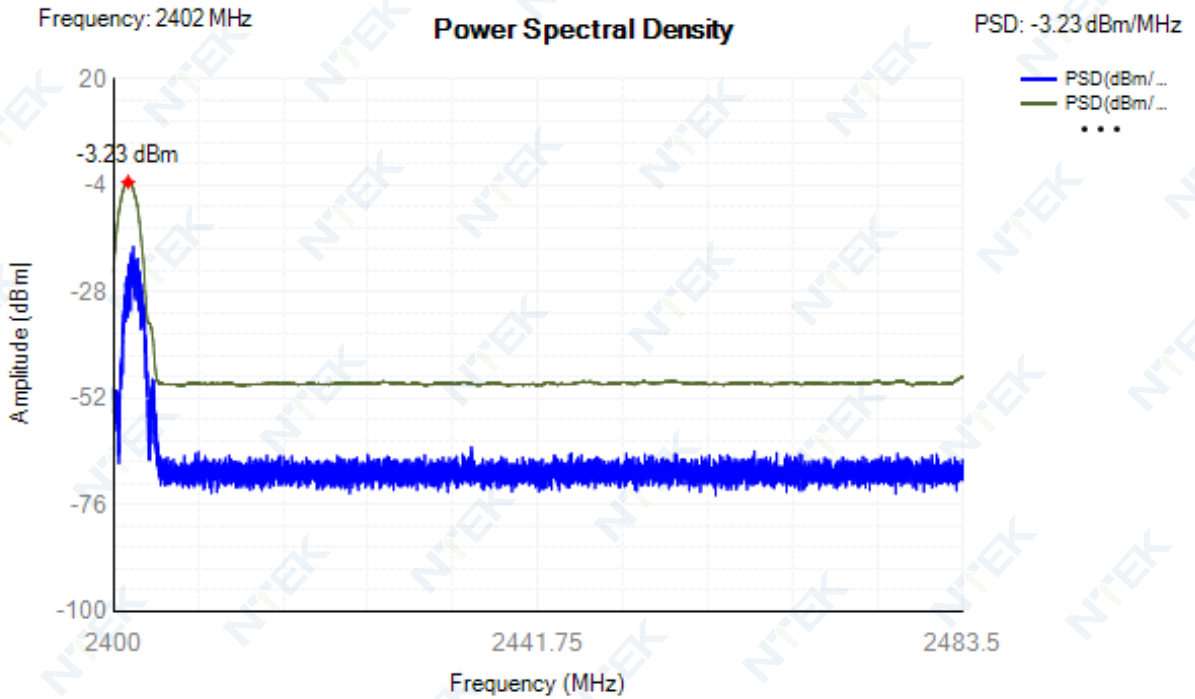

PSD NVNT BLE 2M 2440MHz Ant1

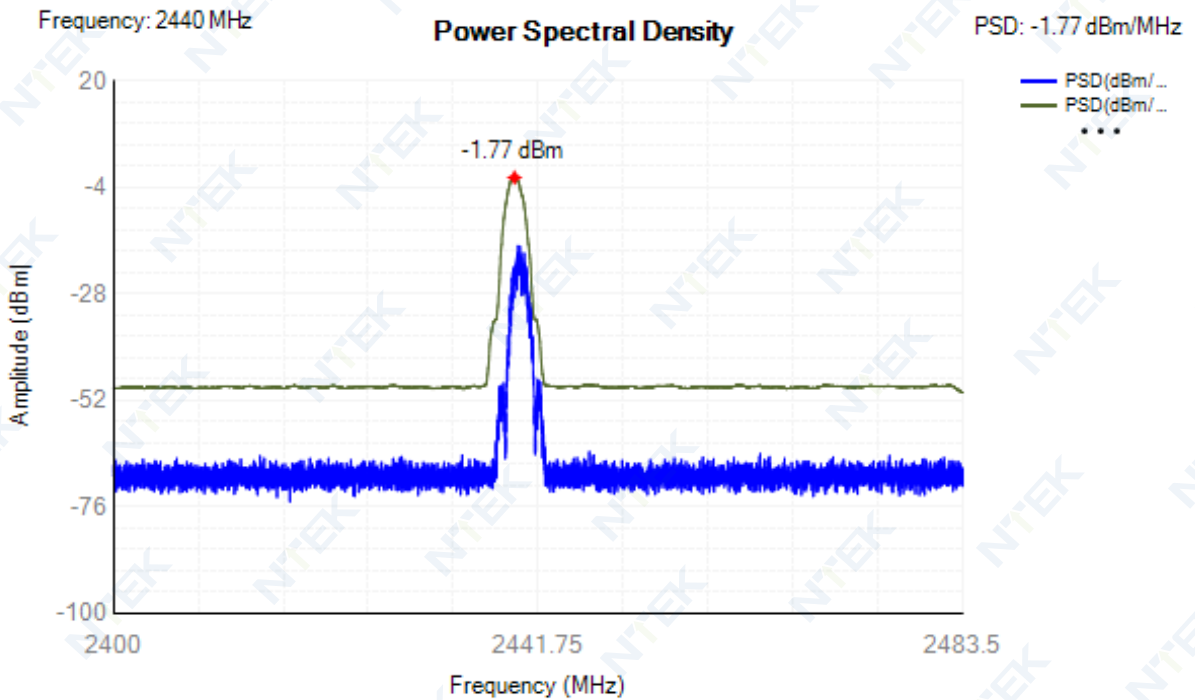

PSD NVNT BLE 2M 2480MHz Ant1

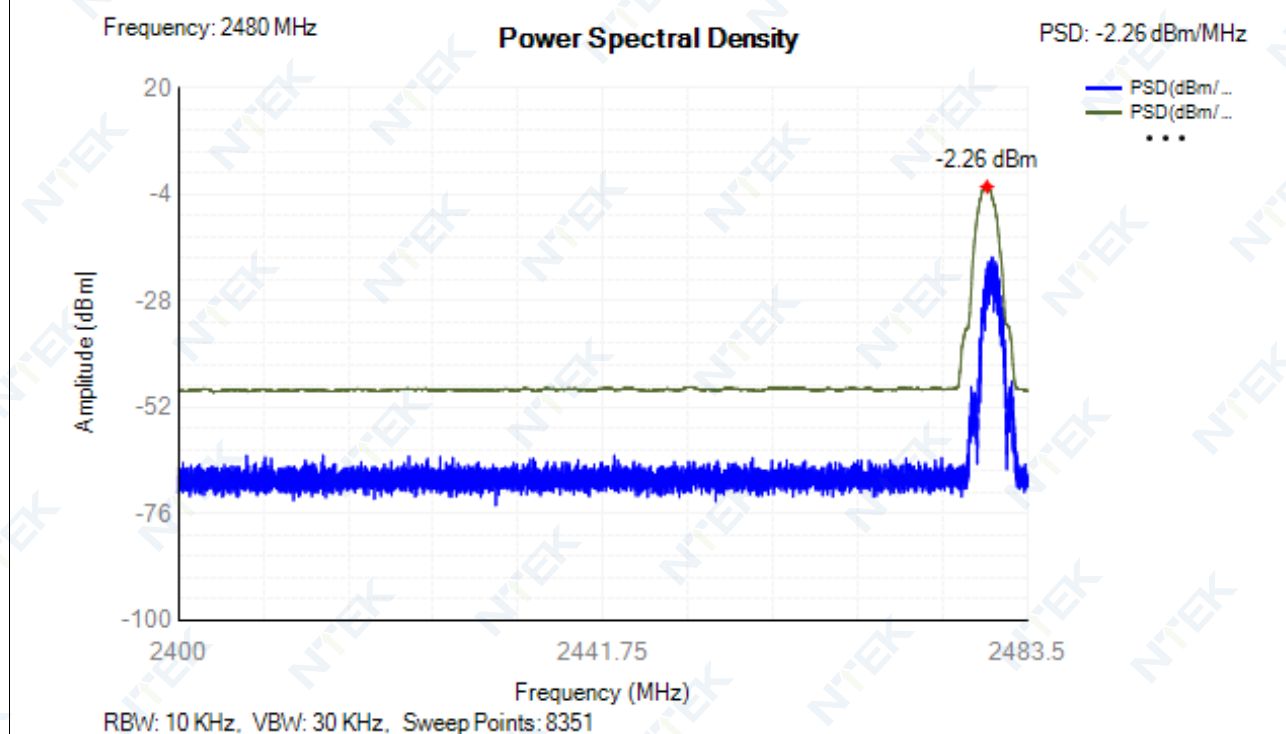

4.2.3 Occupied Channel Bandwidth

Condition	Mode	Frequency (MHz)	Antenna	Center Frequency (MHz)	OBW (MHz)	Lower Edge (MHz)	Upper Edge (MHz)	Limit OBW (MHz)	Verdict
NVNT	BLE 2M	2402	Ant1	2402.018	2.074	2400.981	2403.055	2400 - 2483.5MHz	Pass
NVNT	BLE 2M	2440	Ant1	2440.014	2.074	2438.977	2441.051	2400 - 2483.5MHz	Pass
NVNT	BLE 2M	2480	Ant1	2480.014	2.074	2478.977	2481.051	2400 - 2483.5MHz	Pass

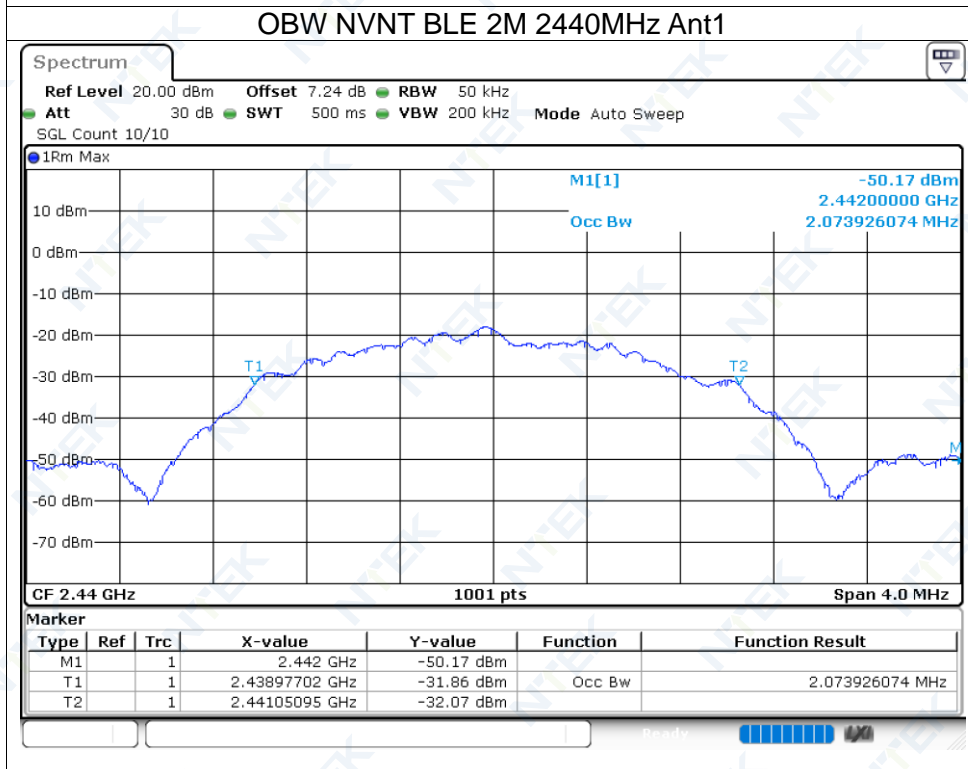
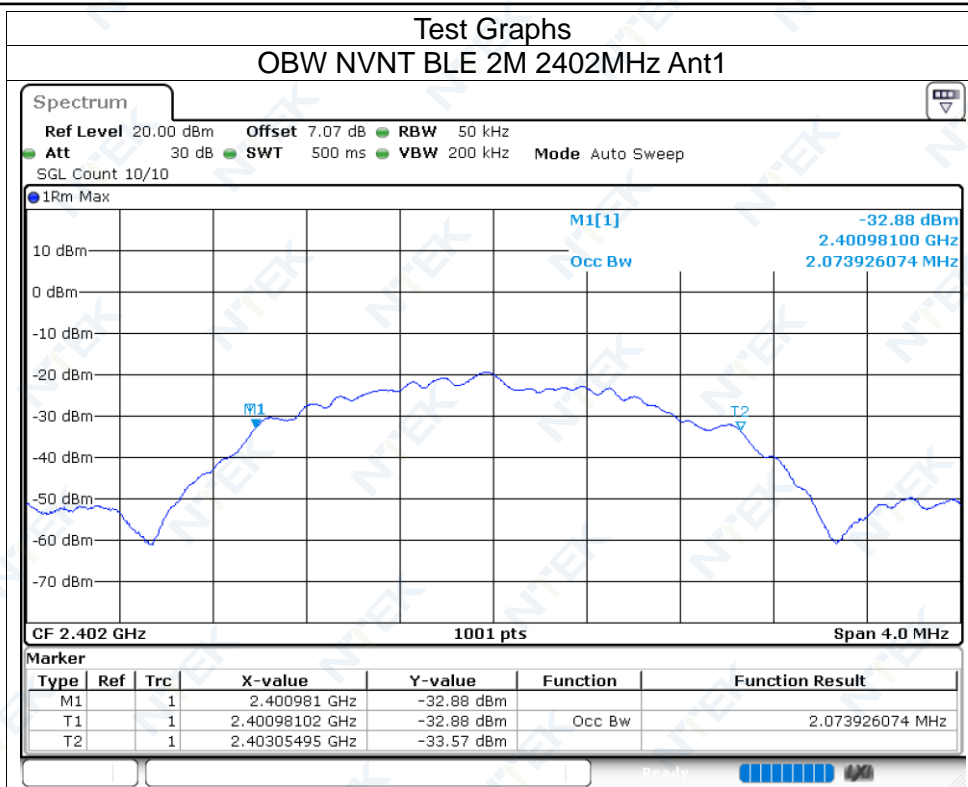

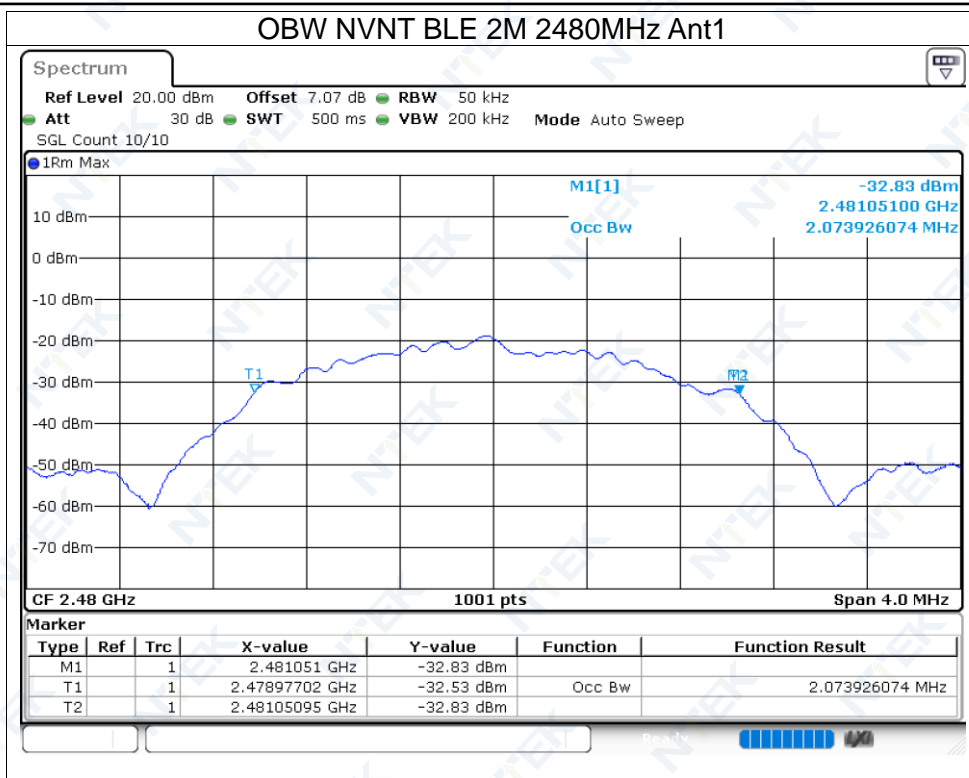

4.2.4 Transmitter unwanted emissions in the out-of-band domain

Condition	Mode	Frequency (MHz)	Antenna	OOB Frequency (MHz)	Level (dBm/MHz)	Limit (dBm/MHz)	Verdict
NVNT	BLE 2M	2402	Ant1	2399.5	-34.09	-10	Pass
NVNT	BLE 2M	2402	Ant1	2398.5	-50.34	-10	Pass
NVNT	BLE 2M	2402	Ant1	2398.426	-50.61	-10	Pass
NVNT	BLE 2M	2402	Ant1	2397.426	-51.66	-20	Pass
NVNT	BLE 2M	2402	Ant1	2396.426	-51.65	-20	Pass
NVNT	BLE 2M	2402	Ant1	2396.352	-51.67	-20	Pass
NVNT	BLE 2M	2402	Ant1	2484	-51.6	-10	Pass
NVNT	BLE 2M	2402	Ant1	2485	-51.58	-20	Pass
NVNT	BLE 2M	2480	Ant1	2399.5	-52.19	-10	Pass
NVNT	BLE 2M	2480	Ant1	2398.5	-51.81	-20	Pass
NVNT	BLE 2M	2480	Ant1	2484	-51.25	-10	Pass
NVNT	BLE 2M	2480	Ant1	2485	-51.4	-10	Pass
NVNT	BLE 2M	2480	Ant1	2485.074	-51.53	-10	Pass
NVNT	BLE 2M	2480	Ant1	2486.074	-51.45	-20	Pass
NVNT	BLE 2M	2480	Ant1	2487.074	-51.43	-20	Pass
NVNT	BLE 2M	2480	Ant1	2487.148	-51.48	-20	Pass

Test Graphs

Tx. Emissions OOB NVNT BLE 2M 2402MHz Ant1

Frequency: 2402 MHz

Transmitter unwanted emissions in the out-of-band domain

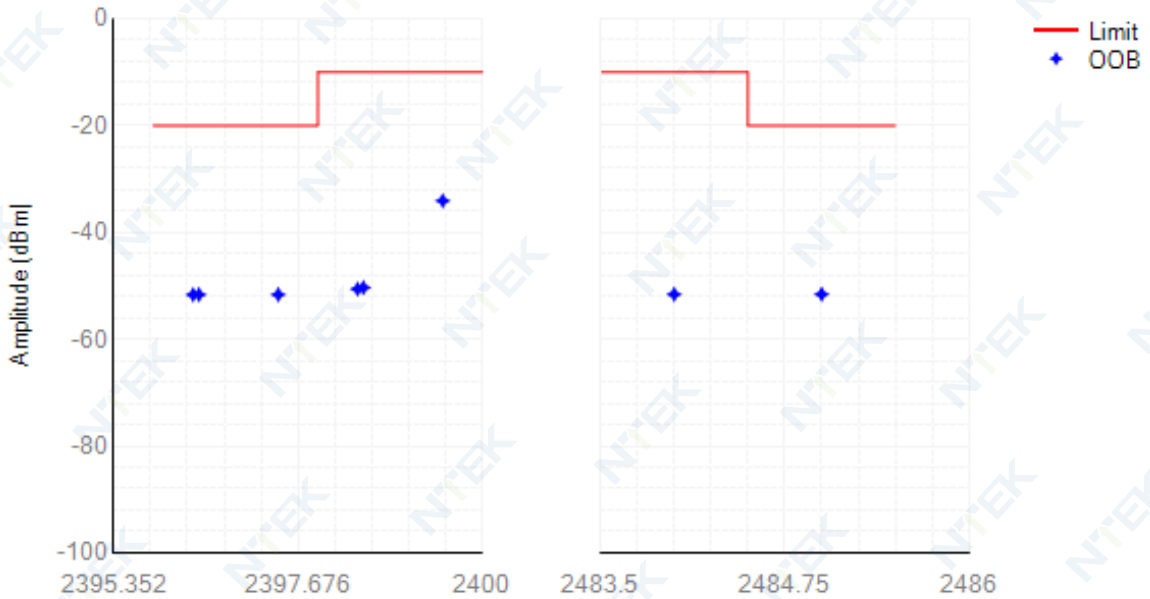

RBW: 1000 KHz, VBW: 3000 KHz, Sweep Points: 5001

Tx. Emissions OOB NVNT BLE 2M 2480MHz Ant1

Frequency: 2480 MHz

Transmitter unwanted emissions in the out-of-band domain

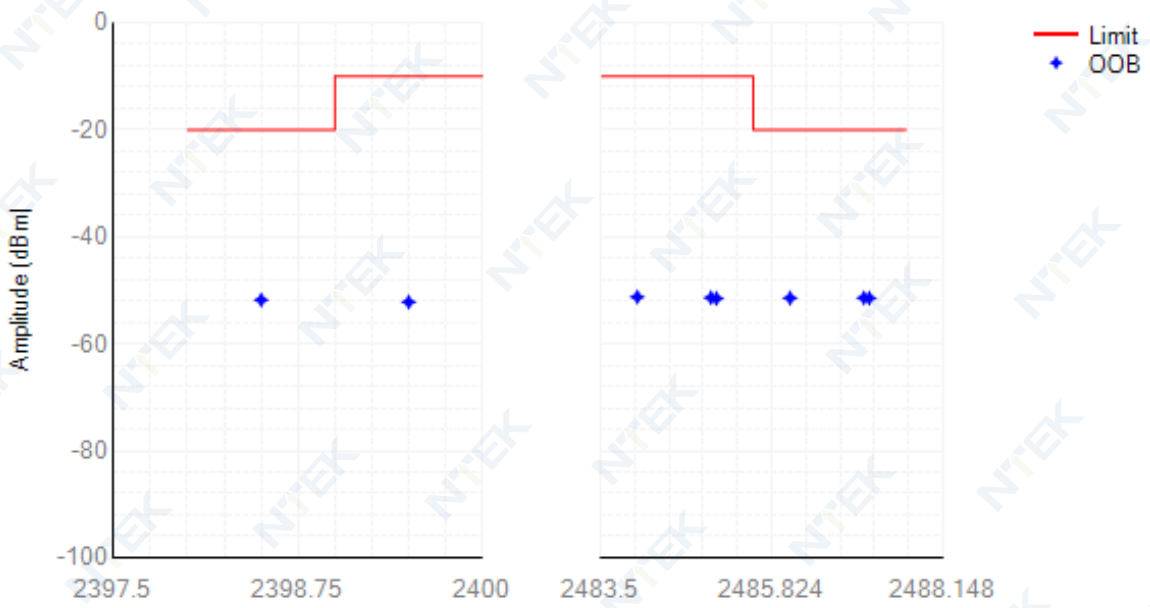

RBW: 1000 KHz, VBW: 3000 KHz, Sweep Points: 5001

4.2.5 Transmitter unwanted emissions in the spurious domain

Condition	Mode	Frequency (MHz)	Antenna	Range (MHz)	Spur Freq (MHz)	Peak (dBm)	RMS (dBm)	Limit (dBm)	Verdict
NVNT	BLE 2M	2402	Ant1	30 -47	41.60	-76.15	NA	-36	Pass
NVNT	BLE 2M	2402	Ant1	47 -74	73.35	-75.69	NA	-54	Pass
NVNT	BLE 2M	2402	Ant1	74 -87.5	86.40	-76.73	NA	-36	Pass
NVNT	BLE 2M	2402	Ant1	87.5 -118	94.25	-75.94	NA	-54	Pass
NVNT	BLE 2M	2402	Ant1	118 -174	139.35	-75.62	NA	-36	Pass
NVNT	BLE 2M	2402	Ant1	174 -230	212.50	-74.91	NA	-54	Pass
NVNT	BLE 2M	2402	Ant1	230 -470	351.40	-74.00	NA	-36	Pass
NVNT	BLE 2M	2402	Ant1	470 -694	525.65	-74.87	NA	-54	Pass
NVNT	BLE 2M	2402	Ant1	694 -1000	917.25	-73.33	NA	-36	Pass
NVNT	BLE 2M	2402	Ant1	1000 -2396	1749.50	-53.16	NA	-30	Pass
NVNT	BLE 2M	2402	Ant1	2487.5 -12750	6832.50	-44.38	NA	-30	Pass
NVNT	BLE 2M	2440	Ant1	30 -47	35.95	-76.14	NA	-36	Pass
NVNT	BLE 2M	2440	Ant1	47 -74	64.15	-76.42	NA	-54	Pass
NVNT	BLE 2M	2440	Ant1	74 -87.5	77.75	-76.64	NA	-36	Pass
NVNT	BLE 2M	2440	Ant1	87.5 -118	103.55	-75.26	NA	-54	Pass
NVNT	BLE 2M	2440	Ant1	118 -174	158.35	-74.78	NA	-36	Pass
NVNT	BLE 2M	2440	Ant1	174 -230	194.90	-74.97	NA	-54	Pass
NVNT	BLE 2M	2440	Ant1	230 -470	374.50	-74.60	NA	-36	Pass
NVNT	BLE 2M	2440	Ant1	470 -694	561.25	-74.24	NA	-54	Pass
NVNT	BLE 2M	2440	Ant1	694 -1000	964.60	-73.26	NA	-36	Pass
NVNT	BLE 2M	2440	Ant1	1000 -2396	2262.50	-52.52	NA	-30	Pass
NVNT	BLE 2M	2440	Ant1	2487.5 -12750	6811.50	-44.87	NA	-30	Pass
NVNT	BLE 2M	2480	Ant1	30 -47	43.40	-76.34	NA	-36	Pass
NVNT	BLE 2M	2480	Ant1	47 -74	47.50	-76.14	NA	-54	Pass
NVNT	BLE 2M	2480	Ant1	74 -87.5	84.80	-74.74	NA	-36	Pass
NVNT	BLE 2M	2480	Ant1	87.5 -118	109.30	-75.37	NA	-54	Pass
NVNT	BLE 2M	2480	Ant1	118 -174	123.20	-76.09	NA	-36	Pass
NVNT	BLE 2M	2480	Ant1	174 -230	229.65	-75.07	NA	-54	Pass
NVNT	BLE 2M	2480	Ant1	230 -470	361.85	-74.68	NA	-36	Pass
NVNT	BLE 2M	2480	Ant1	470 -694	687.25	-74.42	NA	-54	Pass
NVNT	BLE 2M	2480	Ant1	694 -1000	989.15	-73.62	NA	-36	Pass
NVNT	BLE 2M	2480	Ant1	1000 -2396	2300.50	-53.72	NA	-30	Pass
NVNT	BLE 2M	2480	Ant1	2487.5 -12750	6931.00	-45.00	NA	-30	Pass

Test Graphs

Tx. Spurious NVNT BLE 2M 2402MHz Ant1

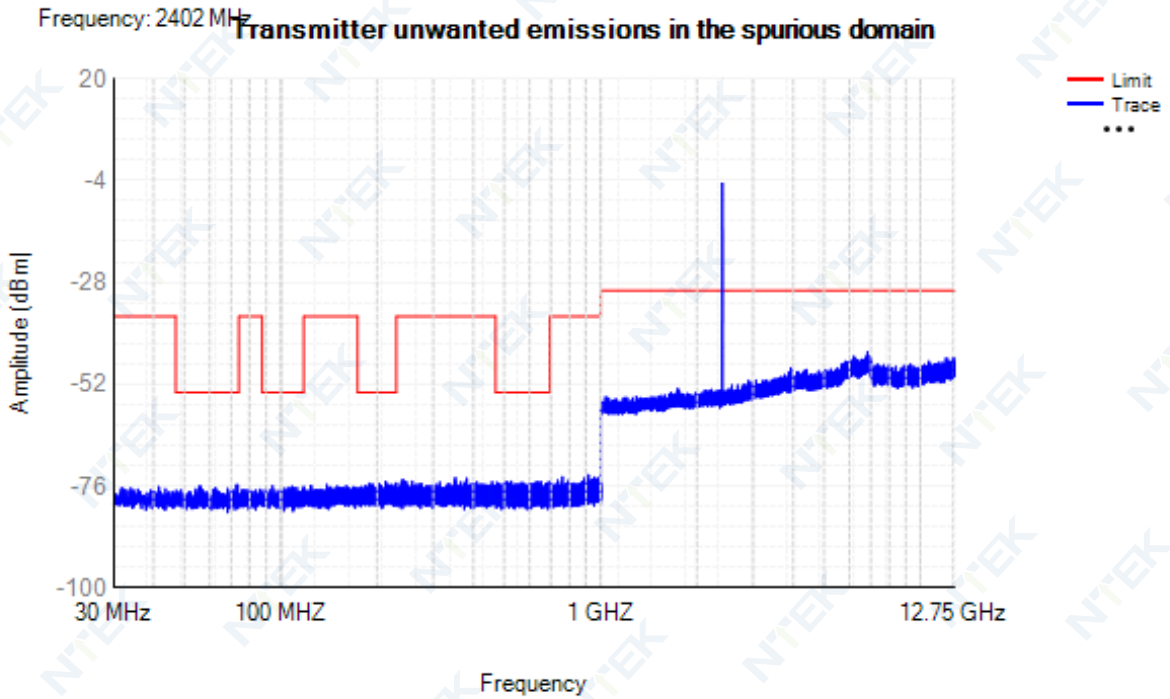

Tx. Spurious NVNT BLE 2M 2440MHz Ant1

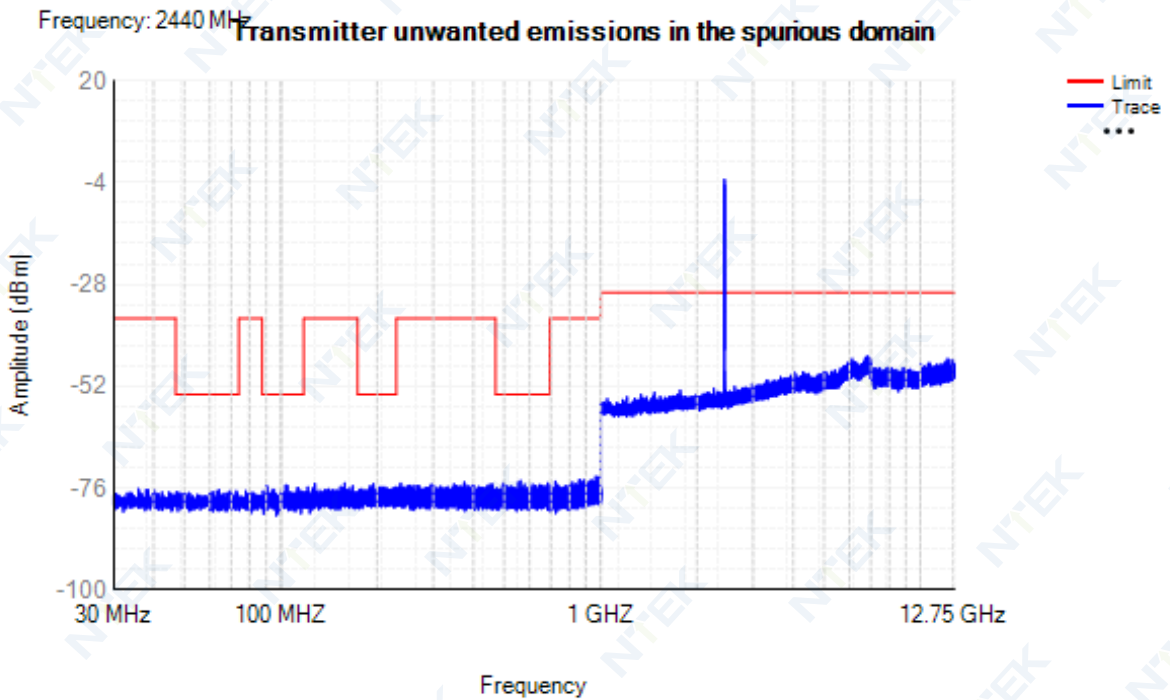

Tx. Spurious NVNT BLE 2M 2480MHz Ant1

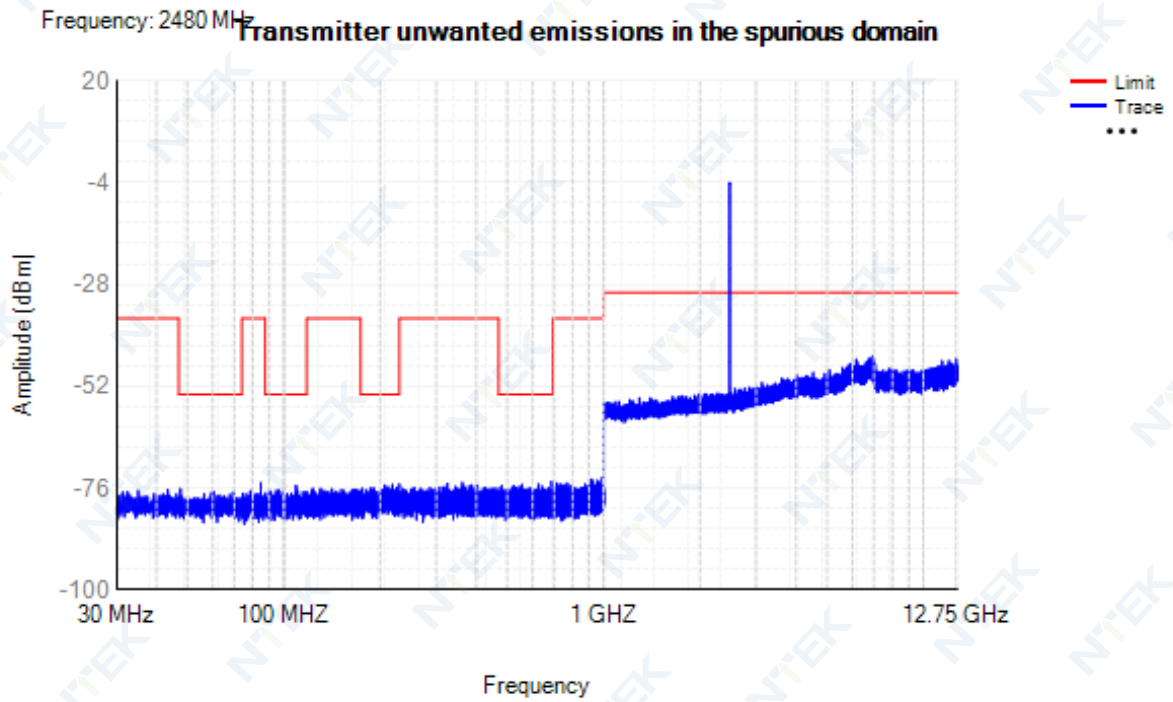

4.2.6 Receiver spurious emissions

Condition	Mode	Frequency (MHz)	Antenna	Range (MHz)	Spur Freq (MHz)	Peak (dBm)	RMS (dBm)	Limit (dBm)	Verdict
NVNT	BLE 2M	2402	Ant1	30 -1000	868.2	-73.96	NA	-57	Pass
NVNT	BLE 2M	2402	Ant1	1000 -12750	6817.5	-54.98	NA	-47	Pass
NVNT	BLE 2M	2440	Ant1	30 -1000	902.05	-73.20	NA	-57	Pass
NVNT	BLE 2M	2440	Ant1	1000 -12750	6844.5	-55.55	NA	-47	Pass
NVNT	BLE 2M	2480	Ant1	30 -1000	898	-74.06	NA	-57	Pass
NVNT	BLE 2M	2480	Ant1	1000 -12750	6988	-55.46	NA	-47	Pass

Test Graphs

Rx. Spurious NVNT BLE 2M 2402MHz Ant1

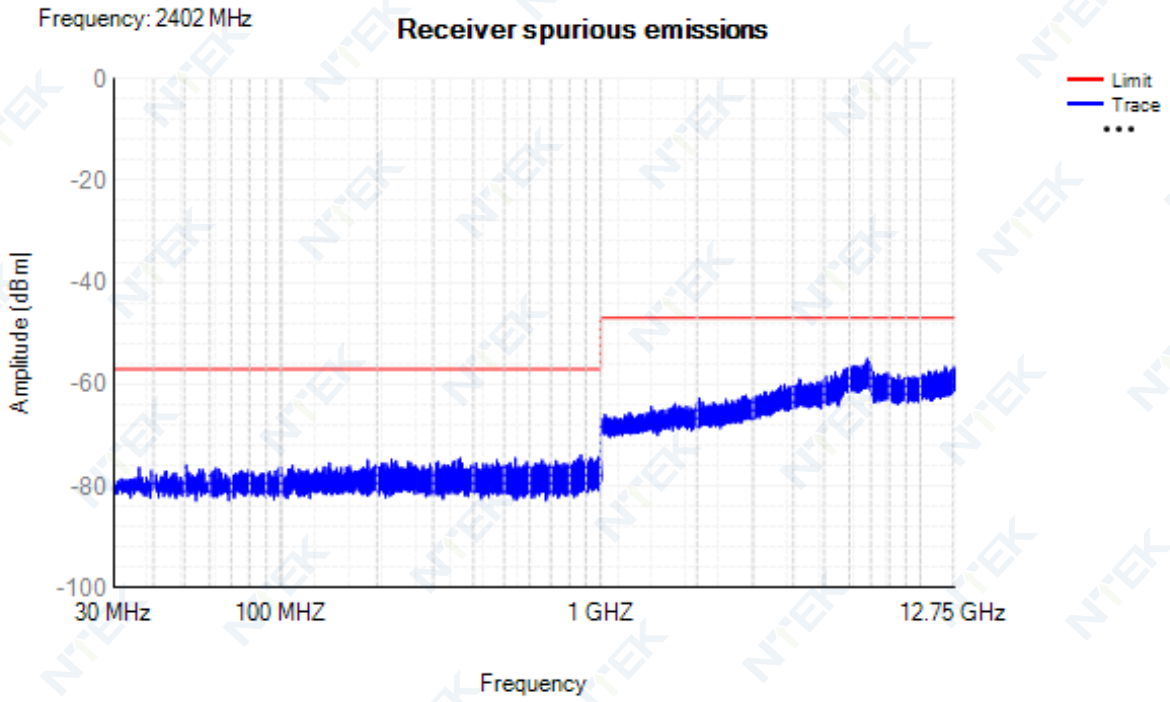

Rx. Spurious NVNT BLE 2M 2440MHz Ant1

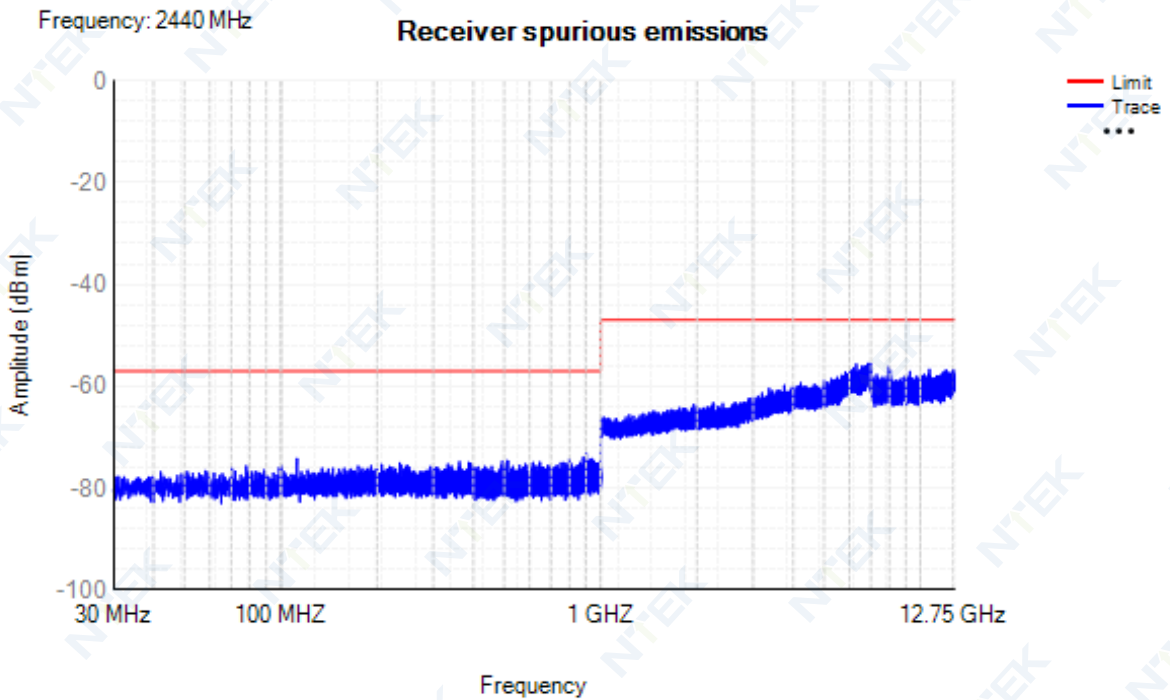

Rx. Spurious NVNT BLE 2M 2480MHz Ant1

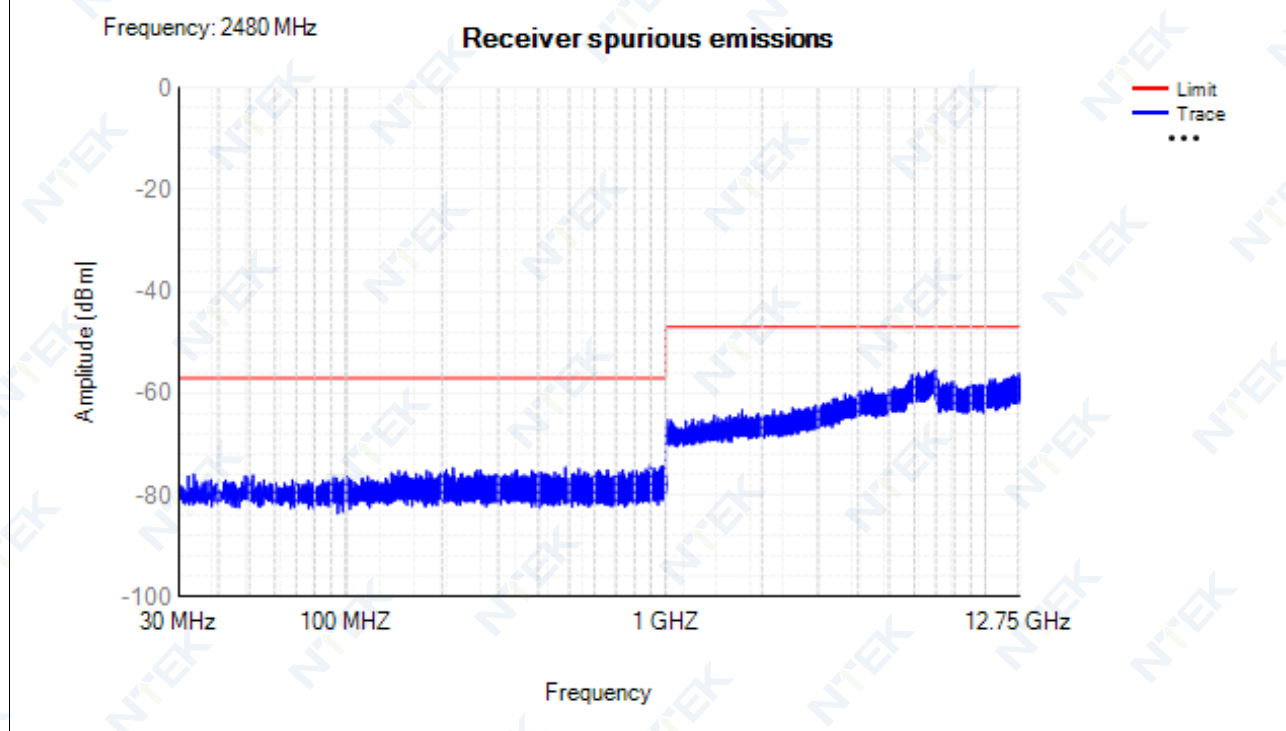

5. EUT TEST PHOTO

SPURIOUS EMISSIONS MEASUREMENT PHOTOS

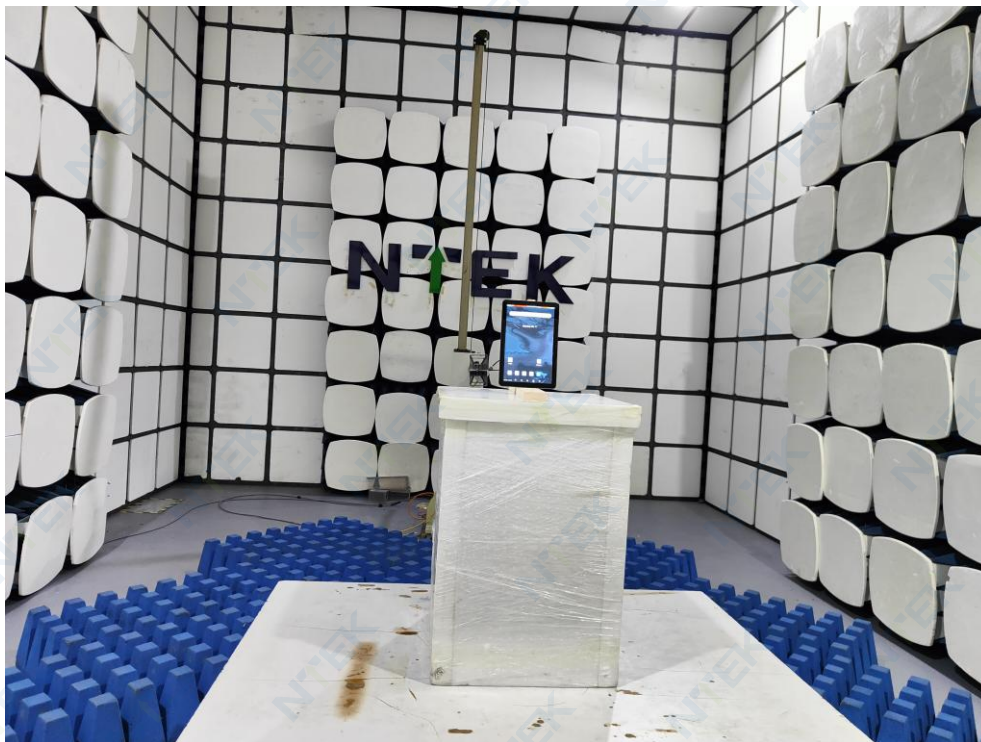
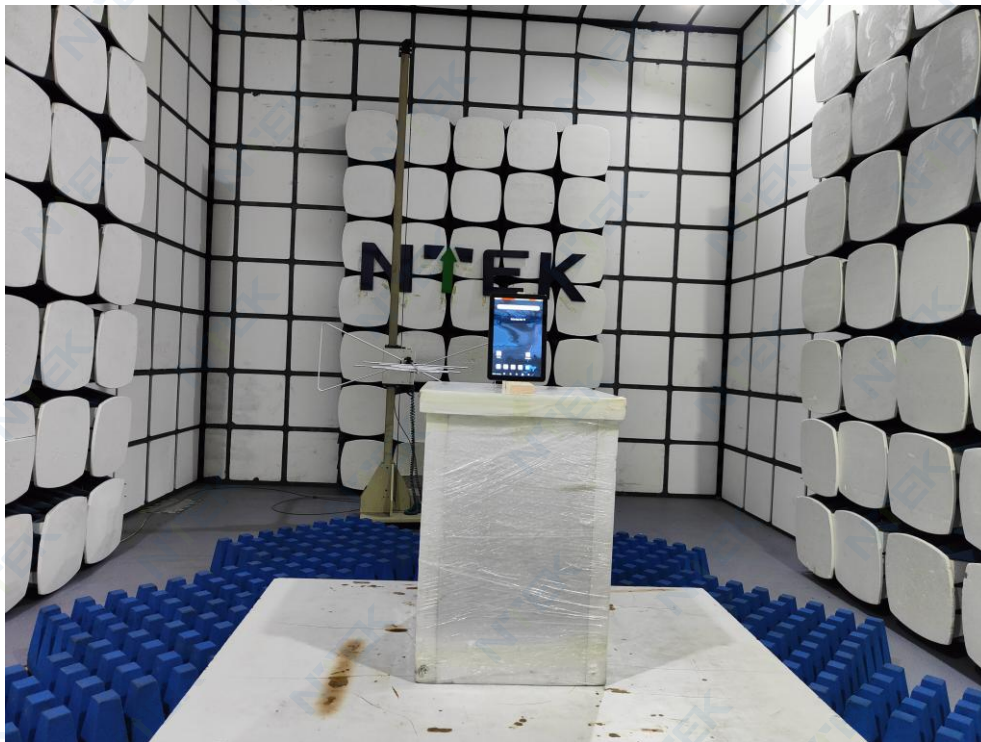

END OF REPORT