



RADIO TEST REPORT-WIFI ETSI EN 300 328 V2.2.2 (2019-07)

Product : 4G Tablet

Trade Mark : Blackview/OSCAL

Model Name : Tab 80

Family Model : Pad 12

Report No. : S23082304803003

Prepared for

DOKE COMMUNICATION (HK) LIMITED

RM 1902 EASEY COMM BLDG 253-261 HENNESSY ROAD WANCHAI HK CHINA

Prepared by

Shenzhen NTEK Testing Technology Co., Ltd.

1/F, Building E, Fenda Science Park, Sanwei Community, Xixiang Street
Bao'an District, Shenzhen 518126 P.R. China

Tel. 400-800-6106, 0755-2320 0050, 0755-2320 0090

Website: <http://www.ntek.org.cn>

TEST RESULT CERTIFICATION

Applicant's name DOKE COMMUNICATION (HK) LIMITED
Address RM 1902 EASEY COMM BLDG 253-261 HENNESSY ROAD
 WANCHAI HK CHINA
Manufacturer's Name Shenzhen DOKE Electronic Co., Ltd
Address 801, Building3, 7th Industrial Zone, Yulv Community, Yutang Road,
 Guangming District, Shenzhen, China.

Product description

Product name 4G Tablet
Trademark Blackview/OSCAL
Model Name Tab 80
Family Model Pad 12

Standards ETSI EN 300 328 V2.2.2 (2019-07)

This device described above has been tested by Shenzhen NTEK, and the test results show that the equipment under test (EUT) is in compliance with the 2014/53/EU RED Directive Art.3.2 requirements. And it is applicable only to the tested sample identified in the report.

This report shall not be reproduced except in full, without the written approval of Shenzhen NTEK, this document may be altered or revised by Shenzhen NTEK, personnel only, and shall be noted in the revision of the document.

Test Sample Number S230613041001

Date of Test

Date (s) of performance of tests Jun 16, 2023 ~ Jul 11, 2023

Date of Issue Sep 05, 2023

Test Result **Pass**

Note: All test data of this report are based on the original test report S23061304101003 dated by Jul 12, 2023

Testing Engineer : Allen Liu
 (Allen Liu)

Authorized Signatory : Alex Li
 (Alex Li)

Table of Contents

Page

1 . GENERAL INFORMATION	6
1.1 GENERAL DESCRIPTION OF EUT	6
1.2 INFORMATION ABOUT THE EUT	8
1.3 TEST CONDITIONS AND CHANNEL	13
1.4 DESCRIPTION OF TEST CONDITIONS	14
1.5 DESCRIPTION OF SUPPORT UNITS	15
1.6 EQUIPMENTS LIST FOR ALL TEST ITEMS	16
2 . SUMMARY OF TEST RESULTS	17
2.1 TEST FACILITY	18
2.2 MEASUREMENT UNCERTAINTY	18
3 . TEST PROCEDURES AND RESULTLS	20
3.1 EQUIVALENT ISOTROPIC RADIATED POWER	20
3.1.1 LIMITS OF EQUIVALENT ISOTROPIC RADIATED POWER	20
3.1.2 TEST PROCEDURE	20
3.1.3 TEST SETUP	20
3.1.4 TEST RESULTS	21
3.2 . PEAK POWER DENSITY	22
3.2.1 LIMITS OF POWER SPECTRAL DENSITY	22
3.2.2 TEST PROCEDURE	22
3.2.3 TEST SETUP	22
3.2.4 TEST RESULTS	23
3.3 . OCCUPIED CHANNEL BANDWIDTH	24
3.3.1 LIMITS OF OCCUPIED CHANNEL BANDWIDTH	24
3.3.2 TEST PROCEDURE	24
3.3.3 DEVIATION FROM TEST STANDARD	24
3.3.4 TEST SETUP	24
3.3.5 TEST RESULTS	25
3.4 . TRANSMITTER UNWANTED EMISSIONS IN THE OUT-OF-BAND DOMAIN	26
3.4.1 LIMITS OF TRANSMITTER UNWANTED EMISSIONS IN THE OUT-OF-BAND DOMAIN	26
3.4.2 TEST PROCEDURE	26
3.4.3 DEVIATION FROM TEST STANDARD	27
3.4.4 TEST SETUP	27
3.4.5 TEST RESULTS	28
3.5 . ADAPTIVE (CHANNEL ACCESS MECHANISM)	29
3.5.1 APPLICABILITY OF ADAPTIVE REQUIREMENTS AND LILIT FOR WIDE BAND MODULATION TECHNIQUES	29
3.5.2 TEST PROCEDURE	30

Table of Contents	Page
3.5.3 TEST SETUP CONFIGURATION	30
3.5.4 LIST OF MEASUREMENTS	31
3.5.5 INTERFERENCE THRESHOLD LEVEL	32
3.6 . TRANSMITTER UNWANTED EMISSIONS IN THE SPURIOUS DOMAIN	33
3.6.1 LIMITS OF TRANSMITTER UNWANTED EMISSIONS IN THE SPURIOUS DOMAIN	33
3.6.2 TEST PROCEDURE	33
3.6.3 DEVIATION FROM TEST STANDARD	33
3.6.4 TEST SETUP	34
3.6.5 TEST RESULTS (Radiated measurement)	35
3.6.6 TEST RESULTS (Conducted measurement)	36
3.7 . RECEIVER SPURIOUS RADIATION	37
3.7.1 LIMITS OF RECEIVER SPURIOUS RADIATION	37
3.7.2 TEST PROCEDURE	37
3.7.3 DEVIATION FROM TEST STANDARD	37
3.7.4 TEST SETUP	38
3.7.5 TEST RESULTS (Radiated measurement)	39
3.7.6 TEST RESULTS (Conducted measurement)	40
3.8 . RECEIVER BLOCKING	41
3.8.1 PERFORMANCE CRITERIA	41
3.8.2 LIMITS OF RECEIVER BLOCKING	41
3.8.3 TEST PROCEDURE	42
3.8.4 DEVIATION FROM TEST STANDARD	43
3.8.5 TEST SETUP	43
3.8.6 TEST RESULTS	44
4 . TEST RESULTS	48
4.1 RF Output Power	48
4.2 Power Spectral Density	56
4.3 Occupied Channel Bandwidth	63
4.4 Transmitter unwanted emissions in the out-of-band domain	70
4.5 Transmitter unwanted emissions in the spurious domain	81
4.6 Receiver spurious emissions	89
4.7 Adaptivity	96
4.8 Adaptivity COT Channel Occupancy Time	104
5 . EUT TEST PHOTO	112
SPURIOUS EMISSIONS MEASUREMENT PHOTOS	112
APPENDIX-PHOTOGRAPHS OF EUT CONSTRUCTIONAL DETAILS	

Revision History

Report No.	Version	Description	Issued Date
S23061304101003	Rev.01	Initial issue of report	Jul 12, 2023
S23082304803003	Rev.02	Added adapter	Sep 05, 2023

1. GENERAL INFORMATION
1.1 GENERAL DESCRIPTION OF EUT

Equipment	4G Tablet
Trade Mark	Blackview/OSCAL
Model Name.	Tab 80
Family Model	Pad 12
Model Difference	All the model are the same circuit and RF module,except the model name, logo, memory.
The EUT is 4G Tablet	
Operation Frequency:	802.11b/g/n(20MHz): 2412~2472MHz 802.11n(40MHz):2422~2462MHz
Modulation Type:	IEEE 802.11b : DSSS (DBPSK, DQPSK, CCK) IEEE 802.11g/n (HT20/HT40) : OFDM (64QAM, 16QAM, QPSK, BPSK)
Bit Rate of Transmitter	802.11b:11/5.5/2/1 Mbps 802.11g:54/48/36/24/18/12/9/6Mbps 802.11n(20MHz) use 800 ns GI: 65.0/58.5/52.0/39.0/26.0/19.5/13.0/6.5 Mbps (MCS0~MCS7) 802.11n(40MHz) use 800 ns GI: 13.5/27/40.5/54/81/108/121.5/135Mbps
Adaptive/non-adaptive	Adaptive equipment
Receiver categories	1
Number Of Channel	Please see Note 2.
Antenna Designation	PIFA Antenna
Antenna Gain(Peak)	1.84 dBi
Channel List	Refer to below
Adapter	Adapter 1: Brand name: OSCAL Model: QZ-01000EA00 Input: 100-240V~50/60Hz 0.3A Output: 5.0V---2.0A (10.0W) Adapter 2: Brand name: Blackview Model: QZ-01000EA00 Input: 100-240V~50/60Hz 0.3A Output: 5.0V---2.0A (10.0W) Adapter 3: Brand name: Blackview Model: QZ-01001EA00 Input: 100-240V~50/60Hz 0.3A Output: 5.0V---2.0A (10.0W)
Battery	DC 3.85V, 7680mAh

Rating	DC 3.85V from battery or DC 5V from adapter
I/O Ports	Refer to users manual
Hardware Version	T30-T616-V2.0
Software Version	Tab80_EEA_T30_V1.0

Note:

1. For a more detailed features description, please refer to the manufacturer's specifications or the User's Manual.
- 2.

Channel List							
Channel	Frequency (MHz)	Channel	Frequency (MHz)	Channel	Frequency (MHz)	Channel	Frequency (MHz)
01	2412	05	2432	09	2452	13	2472
02	2417	06	2437	10	2457		
03	2422	07	2442	11	2462		
04	2427	08	2447	12	2467		

1.2 INFORMATION ABOUT THE EUT

a) The type of modulation used by the equipment:

- FHSS
- other forms of modulation

b) In case of FHSS modulation:

- In case of non-Adaptive Frequency Hopping equipment:
The number of Hopping Frequencies:
- In case of Adaptive Frequency Hopping Equipment:
The maximum number of Hopping Frequencies:
The minimum number of Hopping Frequencies:
- The (average) Dwell Time:

c) Adaptive / non-adaptive equipment:

- non-adaptive Equipment
- adaptive Equipment without the possibility to switch to a non-adaptive mode
- adaptive Equipment which can also operate in a non-adaptive mode

d) In case of adaptive equipment:

The maximum Channel Occupancy Time implemented by the equipment: 5.43ms

- The equipment has implemented an LBT based DAA mechanism
- In case of equipment using modulation different from FHSS:
 - The equipment is Frame Based equipment
 - The equipment is Load Based equipment
 - The equipment can switch dynamically between Frame Based and Load Based equipment
- The CCA time implemented by the equipment: / μ s
- The equipment has implemented a non-LBT based DAA mechanism
- The equipment can operate in more than one adaptive mode

e) In case of non-adaptive Equipment:

The maximum RF Output Power (e.i.r.p.):

The maximum (corresponding) Duty Cycle:

Equipment with dynamic behaviour, that behaviour is described here. (e.g. the different combinations of duty cycle and corresponding power levels to be declared):

f) The worst case operational mode for each of the following tests:

- RF Output Power
802.11 b
- Power Spectral Density
802.11 b
- Duty cycle, Tx-Sequence, Tx-gap
N/A
- Accumulated Transmit time, Frequency Occupation & Hopping Sequence (only for FHSS equipment)
N/A
- Hopping Frequency Separation (only for FHSS equipment)
N/A
- Medium Utilization
N/A
- Adaptivity
802.11 b
- Nominal Channel Bandwidth
802.11 n40
- Transmitter unwanted emissions in the OOB domain
802.11 g
- Transmitter unwanted emissions in the spurious domain
802.11 b
- Receiver spurious emissions
802.11 b
- Receiver Blocking
802.11 g

g) The different transmit operating modes (tick all that apply):

- Operating mode 1: Single Antenna Equipment
 - Equipment with only one antenna
 - Equipment with two diversity antennas but only one antenna active at any moment in time
 - Smart Antenna Systems with two or more antennas, but operating in a (legacy) mode where only one antenna is used (e.g. IEEE 802.11™ [i.3] legacy mode in smart antenna systems)
 - Operating mode 2: Smart Antenna Systems - Multiple Antennas without beam forming
 - Single spatial stream / Standard throughput / (e.g. IEEE 802.11™ [i.3] legacy mode)
 - High Throughput (> 1 spatial stream) using Nominal Channel Bandwidth 1
 - High Throughput (> 1 spatial stream) using Nominal Channel Bandwidth 2

NOTE 1: Add more lines if more channel bandwidths are supported.

- Operating mode 3: Smart Antenna Systems - Multiple Antennas with beam forming
 - Single spatial stream / Standard throughput (e.g. IEEE 802.11™ [i.3] legacy mode)
 - High Throughput (> 1 spatial stream) using Nominal Channel Bandwidth 1
 - High Throughput (> 1 spatial stream) using Nominal Channel Bandwidth 2

NOTE 2: Add more lines if more channel bandwidths are supported.

h) In case of Smart Antenna Systems:

- The number of Receive chains:
- The number of Transmit chains:
 - symmetrical power distribution
 - asymmetrical power distribution

In case of beam forming, the maximum (additional) beam forming gain: dB

NOTE: The additional beam forming gain does not include the basic gain of a single antenna.

i) Operating Frequency Range(s) of the equipment:

- Operating Frequency Range 1: 2412 MHz to 2472 MHz
- Operating Frequency Range 2: 2422 MHz to 2462 MHz

NOTE: Add more lines if more Frequency Ranges are supported.

j) Nominal Channel Bandwidth(s):

- Nominal Channel Bandwidth 1: 17.762MHz (n20)
- Nominal Channel Bandwidth 2: 36.428MHz(n40)

NOTE: Add more lines if more channel bandwidths are supported.

k) Type of Equipment (stand-alone, combined, plug-in radio device, etc.):

- Stand-alone
- Combined Equipment (Equipment where the radio part is fully integrated within another type of equipment)
- Plug-in radio device (Equipment intended for a variety of host systems)
- Other

l) The normal and the extreme operating conditions that apply to the equipment:

Normal operating conditions (if applicable):

Operating temperature: 15°C~35°C

Other (please specify if applicable):

Extreme operating conditions:

Operating temperature range: Minimum: -10°C Maximum 40°C

Other (please specify if applicable): Minimum: Maximum

Details provided are for the:

- stand-alone equipment
- combined (or host) equipment
- test jig

m) The intended combination(s) of the radio equipment power settings and one or more antenna assemblies and their corresponding e.i.r.p. levels:

- Antenna Type: PIFA Antenna

Integral Antenna (information to be provided in case of conducted measurements)

Antenna Gain: 1.84 dBi

If applicable, additional beamforming gain (excluding basic antenna gain): dB

Temporary RF connector provided

No temporary RF connector provided

Dedicated Antennas (equipment with antenna connector)

Single power level with corresponding antenna(s)

Multiple power settings and corresponding antenna(s)

Number of different Power Levels:

Power Level 1: dBm

Power Level 2: dBm

Power Level 3: dBm

NOTE 1: Add more lines in case the equipment has more power levels.

NOTE 2: These power levels are conducted power levels (at antenna connector).

- For each of the Power Levels, provide the intended antenna assemblies, their corresponding gains (G) and the resulting e.i.r.p. levels also taking into account the beamforming gain (Y) if applicable

Power Level 1: dBm

Number of antenna assemblies provided for this power level:

Assembly #	Gain (dBi)	e.i.r.p. (dBm)	Part number or model name
1	1.84	18.24	
2			
3			

NOTE 3: Add more rows in case more antenna assemblies are supported for this power level.

Power Level 2: dBm

Number of antenna assemblies provided for this power level:

Assembly #	Gain (dBi)	e.i.r.p. (dBm)	Part number or model name
1			
2			
3			

NOTE 4: Add more rows in case more antenna assemblies are supported for this power level.

Power Level 3: dBm

Number of antenna assemblies provided for this power level:

Assembly #	Gain (dBi)	e.i.r.p. (dBm)	Part number or model name
1			
2			
3			

NOTE 5: Add more rows in case more antenna assemblies are supported for this power level.

n) The nominal voltages of the stand-alone radio equipment or the nominal voltages of the combined (host) equipment or test jig in case of plug-in devices:

Details provided are for the:

- stand-alone equipment
- combined (or host) equipment
- test jig

Supply Voltage AC mains State AC voltage V
 DC State DC voltage: DC 3.85V

In case of DC, indicate the type of power source

- Internal Power Supply
- External Power Supply or AC/DC adapter: DC 5V
- Battery: DC 3.85V
- Other:

o) Describe the test modes available which can facilitate testing:

See section 1.3

p) The equipment type (e.g. Bluetooth®, IEEE 802.11™ [i.3], IEEE 802.15.4™ [i.4], proprietary, etc.):

IEEE 802.11™ [i.3]

q) If applicable, the statistical analysis referred to in clause 5.4.1 q)

(to be provided as separate attachment)

r) If applicable, the statistical analysis referred to in clause 5.4.1 r)

(to be provided as separate attachment)

s) Geo-location capability supported by the equipment:

- Yes
- The geographical location determined by the equipment as defined in clause 4.3.1.13.2 or clause 4.3.2.12.2 is not accessible to the user
- No

t) Describe the minimum performance criteria that apply to the equipment (see clause 4.3.1.12.3 or clause 4.3.2.11.3):

802.11g(CH01) /PER=0.99%

.....

1.3 TEST CONDITIONS AND CHANNEL

	Normal Test Conditions	Extreme Test Conditions
Temperature	15°C - 35°C	40°C ~ -10°C Note: (1)
Relative Humidity	20% - 75%	N/A
Supply Voltage	DC 3.85V	/

802.11b/11g/11n(20M)

Test Channel	EUT Channel	Test Frequency (MHz)
lowest	CH01	2412
middle	CH07	2442
highest	CH13	2472

802.11n(40M)

Test Channel	EUT Channel	Test Frequency (MHz)
lowest	CH03	2422
middle	CH07	2442
highest	CH11	2462

Note:

- (1) The HT 40°C and LT -10°C was declared by manufacturer, The EUT couldn't be operate normally with higher or lower temperature.
- (2) The measurements are performed at the highest, middle, lowest available channels.

1.4 DESCRIPTION OF TEST CONDITIONS

E-1
EUT

1.5 DESCRIPTION OF SUPPORT UNITS

The EUT has been tested as an independent unit together with other necessary accessories or support units. The following support units or accessories were used to form a representative test configuration during the tests.

Item	Equipment	Model/Type No.	Series No.	Note
E-1	4G Tablet	Tab 80	N/A	EUT

Item	Type	Shielded Type	Ferrite Core	Length	Note

Note:

- (1) The support equipment was authorized by Declaration of Confirmation.
- (2) For detachable type I/O cable should be specified the length in cm in 『Length』 column.

1.6 EQUIPMENTS LIST FOR ALL TEST ITEMS

EQUIPMENT TYPE	Manufacturer	Type No.	Serial No.	Last calibration	Calibrated until	Calibration period
EMI Test Receiver	R&S	ESPI7	101318	2023.03.27	2024.03.26	1 year
Bilog Antenna	TESEQ	CBL6111D	31216	2023.03.16	2024.03.15	1 year
Turn Table	EM	SC100_1	60531	N/A	N/A	N/A
Antnna Mast	EM	SC100	N/A	N/A	N/A	N/A
Horn Antenna	SCHWARZB ECK	BBHA 9120 D	2816	2023.01.12	2024.01.11	1 year
Horn Ant	Schwarzbeck	BBHA 9170	9170-181	2022.11.07	2023.11.06	1 year
Test Cable (30MHz-1GHz)	N/A	R-01	N/A	2022.06.17	2025.06.16	3 year
Test Cable (1-18GHz)	N/A	R-02	N/A	2022.06.17	2025.06.16	3 year
50Ω Coaxial Switch	Anritsu	MP59B	6200983705	2023.05.06	2026.05.05	3 year
Pre-Amplifier	EMC	EMC051835SE	980246	2023.05.29	2024.05.28	1 year
Spectrum Analyzer	Agilent	E4407B	MY45108040	2023.03.31	2024.03.30	1 year
Filter	TRILTHIC	2400MHz	29	2023.03.27	2026.03.26	3 year
Attenuator	Weinschel	33-10-33	AR4010	2023.03.27	2026.03.26	3 year
Attenuator	Weinschel	24-20-34	BP4485	2023.03.27	2026.03.26	3 year
MXA Signal Analyzer	Agilent	N9020A	MY49100060	2023.05.29	2024.05.28	1 year
ESG VETCTOR SIGNAL GENERAROR	Agilent	E4438C	MY45093347	2023.03.21	2024.03.20	1 year
Power Splitter	Mini-Circuits/ USA	ZN2PD-63-S+	SF025101428	2023.03.27	2026.03.26	3 year
Coupler	Mini-Circuits	ZADC-10-63-S +	SF794101410	2023.03.27	2026.03.26	3 year
Directional Coupler	MCLI/USA	CB11-20	0D2L51502	2020.07.17	2023.07.16	3 year
Attenuator	Agilent	8495B	MY42147029	2023.03.27	2026.03.26	3 year
Power Meter	DARE	RPR3006W	15I00041SNO 84	2023.05.29	2024.05.28	1 year
MXG Vector Signal Generator	Agilent	N5182A	MY47070317	2023.05.29	2024.05.28	1 year
Wideband Radio Communication Tester Specifications	R&S	CMW500	148500	2023.05.29	2024.05.28	1 year
temporary antenna connector (Note)	NTS	R001	N/A	N/A	N/A	N/A

Note:

We will use the temporary antenna connector (soldered on the PCB board) When conducted test And this temporary antenna connector is listed within the instrument list

2. SUMMARY OF TEST RESULTS

The EUT has been tested according to the following specifications:

ETSI EN 300 328 V2.2.2 (2019-07)		
Clause	Test Item	Results
TRANSMITTER PARAMETERS		
4.3.2.2	RF Output Power	Pass
4.3.2.3	Power Spectral Density	Pass
4.3.2.4	Duty cycle, Tx-Sequence, Tx-gap	Pass
4.3.2.5	Medium Utilization (MU) factor	Not Applicable (See Note 1/2)
4.3.2.6	Adaptivity	Pass
4.3.2.7	Occupied Channel Bandwidth	Pass
4.3.2.8	Transmitter unwanted emission in the OOB domain	Pass
4.3.2.9	Transmitter unwanted emissions in the spurious domain	Pass
RECEIVER PARAMETERS		
4.3.2.10	Receiver Spurious Emissions	Pass
4.3.2.11	Receiver Blocking	Pass

Note:

1. These requirements do not apply for equipment with a maximum declared RF output power of less than 10 dBm EIRP or for equipment when operating in a mode where the RF output power is less than 10 dBm EIRP.
2. These requirements apply to non-adaptive frequency hopping equipment or to adaptive frequency hopping equipment operating in a non-adaptive mode.
3. The antenna gain provided by customer is used to calculate the EIRP result. NTEK is not responsible for the accuracy of antenna gain parameter

2.1 TEST FACILITY

Shenzhen NTEK Testing Technology Co., Ltd.

Add. : 1/F, Building E, Fenda Science Park, Sanwei Community, Xixiang Street, Bao'an District, Shenzhen 518126 P.R. China

FCC Registered No.: 463705 IC Registered No.:9270A-1

CNAS Registration No.:L5516

2.2 MEASUREMENT UNCERTAINTY

The reported uncertainty of measurement $y \pm U$, where expanded uncertainty U is based on a standard uncertainty multiplied by a coverage factor of $k=2$, providing a level of confidence of approximately **95 %**.

No.	Item	Uncertainty
1	Radio Frequency	$\pm 1.38\text{dB}$
2	Total RF power, conducted	$\pm 0.16\text{dB}$
3	RF power density, conducted	$\pm 0.16\text{dB}$
4	All emissions, radiated	$\pm 0.21\text{dB}$
5	Temperature	$\pm 0.5^\circ\text{C}$
6	Humidity	$\pm 2\%$
7	DC and low Frequency voltages	$\pm 0.04\%$

2.3 MAXIMUM MEASUREMENT UNCERTAINTY (FOR ETSI EN 300 328)

For the test methods, according to ETSI EN 300 328 standard, the measurement uncertainty figures shall be calculated in accordance with ETR 100 028-1[4] and shall correspond to an expansion factor(coverage factor) $k=1.96$ or $k=2$ (which provide confidence levels of respectively **95 %** and **95.45 %** in the case where the distributions characterizing the actual measurement uncertainties are normal (Gaussian)).

Maximum measurement uncertainty

No.	Item	Uncertainty
1	Occupied Channel Bandwidth	$\pm 5\%$
2	RF output Power,conducted	$\pm 1.5\text{dB}$
3	Power Spectral Density, conducted	$\pm 3\text{dB}$
4	Unwanted emissions, conducted	$\pm 3\text{dB}$
5	All emissions,radiated	$\pm 6\text{dB}$
6	Temperature	$\pm 3^{\circ}\text{C}$
7	Humidity	$\pm 3\%$
9	Time	$\pm 5\%$

3. TEST PROCEDURES AND RESULTS

3.1 EQUIVALENT ISOTROPIC RADIATED POWER

3.1.1 LIMITS OF EQUIVALENT ISOTROPIC RADIATED POWER

Refer to chapter 4.3.2.2.3 of ETSI EN 300 328 V2.2.2 (2019-07)

RF OUTPUT POWER	
Condition	Limit
<input type="checkbox"/> Non-adaptive wide band modulations systems	Equal to or less than the value declared by the supplier. This declared value shall be equal to or less than 20 dBm.
<input checked="" type="checkbox"/> Adaptive wide band modulations systems	≤20dBm

3.1.2 TEST PROCEDURE

Refer to chapter 5.4.2.2 of ETSI EN 300 328 V2.2.2 (2019-07)

Measurement	
<input checked="" type="checkbox"/> Conducted measurement	<input type="checkbox"/> Radiated measurement

3.1.3 TEST SETUP

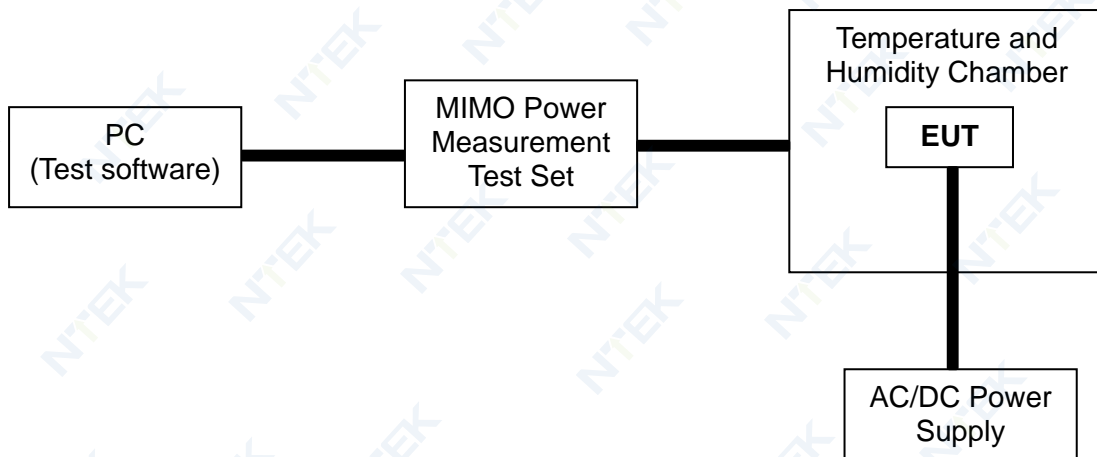

3.1.4 TEST RESULTS

EUT :	4G Tablet	Model Name :	Tab 80
Temperature :	20°C	Relative Humidity:	55 %
Pressure :	1012 hPa	Test Voltage :	DC 3.85V
Test Mode :	802.11 b/g/n(HT20, HT40) Mode		

Test data reference attachment

3.2. PEAK POWER DENSITY

3.2.1 LIMITS OF POWER SPECTRAL DENSITY

Refer to chapter 4.3.2.3.3 of ETSI EN 300 328 V2.2.2 (2019-07)

RF OUTPUT POWER	
Condition	Limit
For equipment using wide band modulations other than FHSS	≤10 dBm/MHz

3.2.2 TEST PROCEDURE

Refer to chapter 5.4.3.2 of ETSI EN 300 328 V2.2.2 (2019-07)

Measurement	
<input checked="" type="checkbox"/> Conducted measurement	<input type="checkbox"/> Radiated measurement

The setting of the Spectrum Analyzer

Start Frequency	2400MHz
Stop Frequency	2483.5MHz
Detector	RMS
Sweep Point	> 8 350; for spectrum analysers not supporting this number of sweep points, the frequency band may be segmented
Sweep time:	For non-continuous transmissions: 2 × Channel Occupancy Time × number of sweep points For continuous transmissions: 10 s; the sweep time may be increased further until a value where the sweep time has no further impact anymore on the RMS value of the signal.
RBW / VBW	10KHz / 30KHz

3.2.3 TEST SETUP

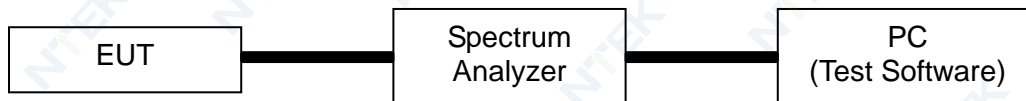

3.2.4 TEST RESULTS

EUT :	4G Tablet	Model Name :	Tab 80
Temperature :	26°C	Relative Humidity:	60 %
Pressure :	1012 hPa	Test Voltage :	DC 3.85V
Test Mode :	802.11 b/g/n(HT20, HT40) Mode		

Test data reference attachment

3.3. OCCUPIED CHANNEL BANDWIDTH

3.3.1 LIMITS OF OCCUPIED CHANNEL BANDWIDTH

Refer to chapter 4.3.2.7.3 of ETSI EN 300 328 V2.2.2 (2019-07)

OCCUPIED CHANNEL BANDWIDTH		
Condition		Limit
All types of equipment		Shall fall completely within the band 2400 to 2483.5 MHz
Additional requirement	For non-adaptive using wide band modulations other than FHSS system and E.I.R.P >10 dBm	Less than 20 MHz
	For non-adaptive frequency hopping system and E.I.R.P >10 dBm	Less than 5 MHz

3.3.2 TEST PROCEDURE

Refer to chapter 5.4.7.2 of ETSI EN 300 328 V2.2.2 (2019-07)

Measurement	
<input checked="" type="checkbox"/> Conducted measurement	<input type="checkbox"/> Radiated measurement

The setting of the Spectrum Analyzer

Center Frequency	The centre frequency of the channel under test
Frequency Span	2 x Nominal Channel Bandwidth
Detector	RMS
RBW	~ 1 % of the span without going below 1 %
VBW	3 x RBW
Trace	Max hold
Sweep time	1s

3.3.3 DEVIATION FROM TEST STANDARD

No deviation

3.3.4 TEST SETUP



These measurements only were performed at normal test conditions. The measurement shall be performed only on the lowest and the highest frequency within the ststed frequency range. In case of conducted measurements the transmitter shall be connected to the measuring equipment via a suitable attenuator. Controlling software has been activated to set the EUT on specific status.

3.3.5 TEST RESULTS

EUT :	4G Tablet	Model Name :	Tab 80
Temperature :	26°C	Relative Humidity :	60 %
Pressure :	1012 hPa	Test Voltage :	DC 3.85V
Test Mode :	802.11b/g/n(HT20, HT40) Mode CH1 / CH13, CH3 / CH11		

Test data reference attachment

3.4. TRANSMITTER UNWANTED EMISSIONS IN THE OUT-OF-BAND DOMAIN

3.4.1 LIMITS OF TRANSMITTER UNWANTED EMISSIONS IN THE OUT-OF-BAND DOMAIN

Refer to chapter 4.3.2.8.3 of ETSI EN 300 328 V2.2.2 (2019-07)

TRANSMITTER UNWANTED EMISSIONS IN THE OUT-OF-BAND DOMAIN	
Condition	Limit
Under all test conditions	The transmitter unwanted emissions in the out-of-band domain but outside the allocated band, shall not exceed the values provided by the mask in below figure.

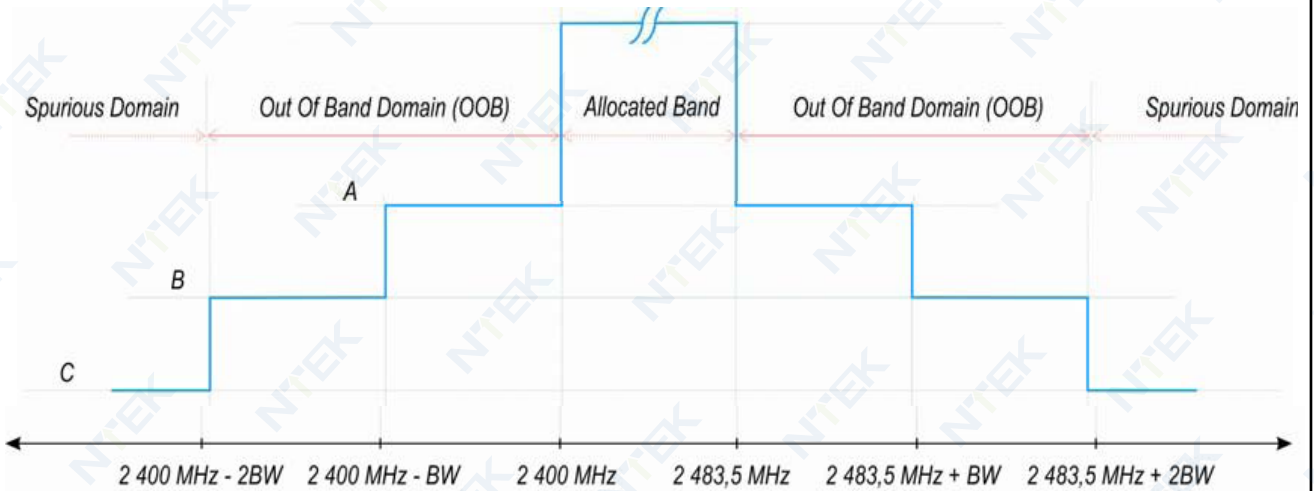

A: -10 dBm/MHz e.i.r.p.

B: -20 dBm/MHz e.i.r.p.

C: Spurious Domain limits

BW = Occupied Channel Bandwidth in MHz or 1 MHz whichever is greater

3.4.2 TEST PROCEDURE

Refer to chapter 5.4.8.2 of ETSI EN 300 328 V2.2.2 (2019-07)

Measurement	
<input checked="" type="checkbox"/> Conducted measurement	<input type="checkbox"/> Radiated measurement

The setting of the Spectrum Analyzer

Span	0Hz
Filter Mode	Channel Filter
Trace Mode	Max Hold
Trigger Mode	Video trigger; in case video triggering is not possible, an external trigger source may be used
Detector	RMS
Sweep Point / Sweep Mode	Sweep Time [s] / (1 μs) or 5 000 whichever is greater/ Continuous
RBW / VBW	1MHz / 3MHz

3.4.3 DEVIATION FROM TEST STANDARD

No deviation

3.4.4 TEST SETUP

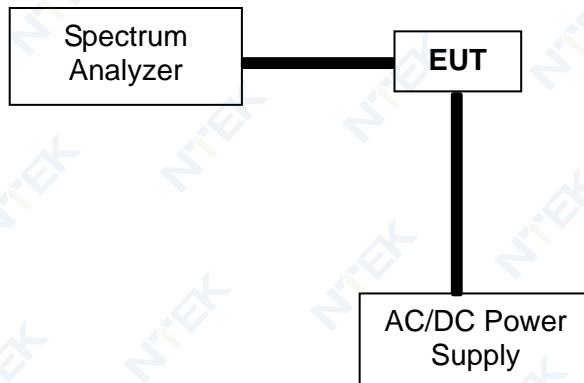

According to the ETSI EN 300328 V2.2.2 clause 5.4.8.1: These measurements shall only be performed at normal test conditions. For equipment using FHSS modulation, the measurements shall be performed during normal operation (hopping).

For equipment using wide band modulations other than FHSS, the measurement shall be performed at the lowest and the highest channel on which the equipment can operate. These operating channels shall be recorded.

The equipment shall be configured to operate under its worst case situation with respect to output power.

If the equipment can operate with different Nominal Channel Bandwidths (e.g. 20 MHz and 40 MHz), then each channel bandwidth shall be tested separately.

3.4.5 TEST RESULTS

EUT :	4G Tablet	Model Name :	Tab 80
Temperature :	24 °C	Relative Humidity :	54%
Pressure :	1010 hPa	Test Power :	DC 3.85V
Test Mode :	802.11 b/g/n(HT20, HT40) Mode		

Test data reference attachment

3.5. ADAPTIVE (CHANNEL ACCESS MECHANISM)

3.5.1 APPLICABILITY OF ADAPTIVE REQUIREMENTS AND LILT FOR WIDE BAND MODULATION TECHNIQUES

Refer to chapter 4.3.2.6 of ETSI EN 300 328 V2.2.2 (2019-07)

Requirement	Operational Mode			
	<input type="checkbox"/> Non-LBT based Detect and Avoid	<input checked="" type="checkbox"/> LBT based Detect and Avoid		
		<input type="checkbox"/> Frame Based Equipment	<input checked="" type="checkbox"/> Load Based Equipment (CCA using 'energy detect')	<input type="checkbox"/> Load Based Equipment (CCA not using any of the mechanisms referenced as note 2)
Minimum Clear Channel Assessment (CCA) Time	NA	not less than 18 us (see note 1)	(see note 2)	not less than 18 us (see note 1)
Maximum Channel Occupancy (COT) Time	<40 ms	1ms to 10 ms	(see note 2)	(13/32)*q ms (see note 3)
Minimum Idle Period	5 % minimum of 100 µs	5% of COT	(see note 2)	NA
Extended CCA check	NA	NA	(see note 2)	R*CCA (see note 4)
Short Control Signalling Transmissions	Maximum duty cycle of 10% within an observation period of 50 ms (see note 5)			

Note 1: The CCA time used by the equipment shall be declared by the supplier.

Note 2: Load Based Equipment may implement an LBT based spectrum sharing mechanism based on the Clear Channel Assessment (CCA) mode using energy detect as described in IEEE 802.11™-2012 [i.3], clause 9, clause 10, clause 16, clause 17, clause 19 and clause 20, or in IEEE 802.15.4™-2011 [i.4], clause 4, clause 5 and clause 8 providing the equipment complies with the conformance requirements referred to in clause 4.3.2.6.3.4.

Note 3: q is selected by the manufacturer in the range [4...32]

Note 4: The value of R shall be randomly selected in the range [1...q]

Note 5: Adaptive equipment may or may not have Short Control Signaling Transmissions.

Interference threshold level

The detection threshold shall be proportional to the transmit power of the transmitter: for a 20 dBm e.i.r.p. transmitter the detection threshold level (TL) shall be equal to or less than -70 dBm/MHz at the input to the receiver assuming a 0 dBi (receive) antenna assembly. This threshold level (TL) may be corrected for the (receive) antenna assembly gain (G); however, beamforming gain (Y) shall not be taken into account. For power levels less than 20 dBm e.i.r.p., the detection threshold level may be relaxed to:

$$TL = -70 \text{ dBm/MHz} + 10 \times \log_{10} (100 \text{ mW} / P_{out}) \text{ (Pout in mW e.i.r.p.)}$$

Table 9: Unwanted Signal parameters

Wanted signal mean power from companion device (dBm)	Unwanted signal frequency (MHz)	Unwanted CW signal power (dBm)
-30/ sufficient to maintain the link(see note 2)	2 395 or 2 488,5 (see note 1)	-35 (see note 2)

NOTE 1: The highest frequency shall be used for testing operating channels within the range 2 400 MHz to 2 442 MHz, while the lowest frequency shall be used for testing operating channels within the range 2 442 MHz to 2 483,5 MHz. See clause 5.4.6.1.

NOTE 2: A typical value which can be used in most cases is -50 dBm/MHz.

NOTE 3: The level specified is the level in front of the UUT antenna. In case of conducted measurements, this level has to be corrected by the actual antenna assembly gain.

3.5.2 TEST PROCEDURE

Refer to chapter 5.4.6.2 of ETSI EN 300 328 V2.2.2 (2019-07)

Measurement	
<input checked="" type="checkbox"/> Conducted measurement	<input type="checkbox"/> Radiated measurement

Test method please refer to the 5.4.6.2.1.4 of ETSI EN 300 328 V2.2.2 (2019-07).

3.5.3 TEST SETUP CONFIGURATION

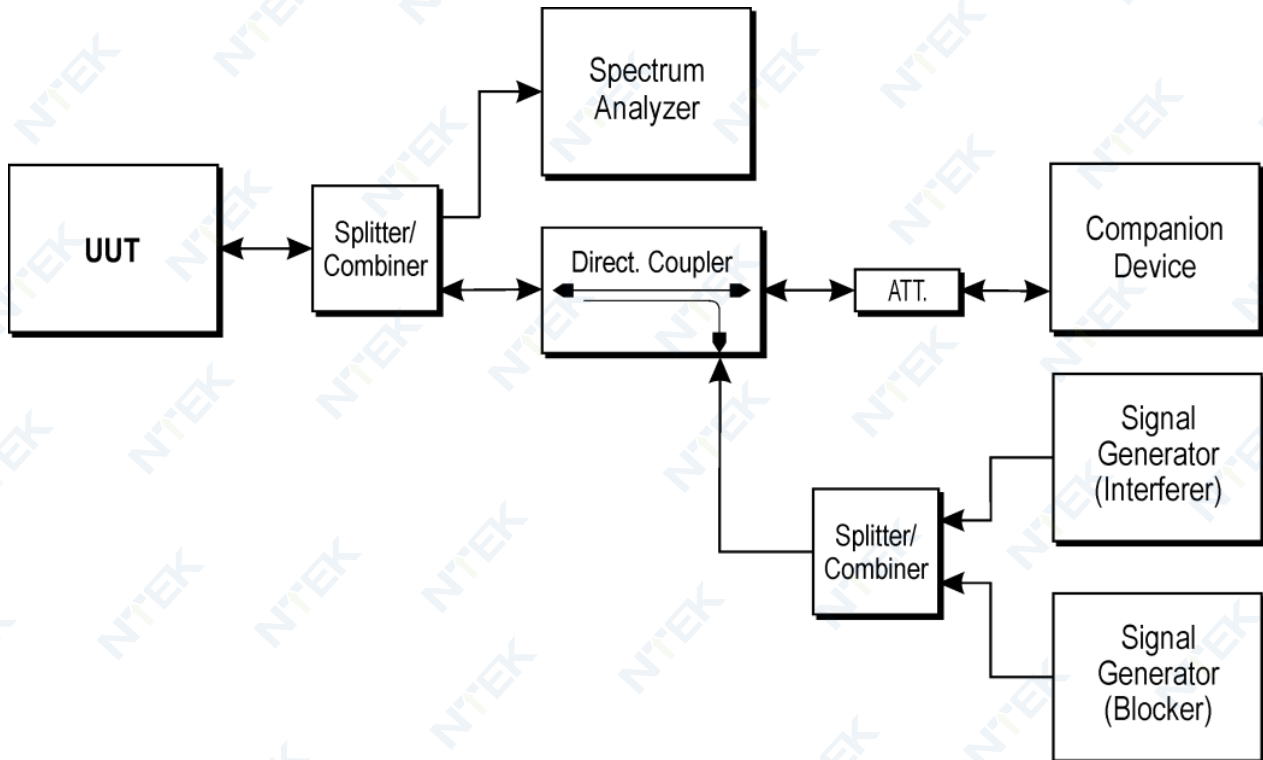

3.5.4 LIST OF MEASUREMENTS

UUT operational Mode		
Frame Based Equipment	Load Based Equipment (CCA using 'energy detect')	Load Based Equipment (CCA not using any of the mechanisms referenced)
	V	

Clause	Test Parameter	Remarks	PASS/FAIL
4.3.2.5.2.2.1	Adaptive (Frame Based Equipment)	Not Applicable	N/A
4.3.2.5.2.2.2	Adaptive (Load Based Equipment)	Applicable	PASS
4.3.2.5.3	Short Control Signaling Transmissions	Applicable	PASS

3.5.5 INTERFERENCE THRESHOLD LEVEL

EUT :	4G Tablet	Model Name :	Tab 80
Temperature :	24 °C	Relative Humidity :	54%
Pressure :	1010 hPa	Test Power :	DC 3.85V
Test Mode :	802.11b/g/n(HT20,HT40) Mode CH1 / CH13,CH3/CH11		

Test data reference attachment

3.6. TRANSMITTER UNWANTED EMISSIONS IN THE SPURIOUS DOMAIN

3.6.1 LIMITS OF TRANSMITTER UNWANTED EMISSIONS IN THE SPURIOUS DOMAIN

Refer to chapter 4.3.2.9.3 of ETSI EN 300328 V2.2.2 (2019-07)

TRANSMITTER UNWANTED EMISSIONS IN THE SPURIOUS DOMAIN		
Frequency Range	Maximum Power Limit (E.R.P.(≤1 GHz) E.I.R.P.(> 1 GHz))	Bandwidth
30 MHz to 47 MHz	-36dBm	100 kHz
47 MHz to 74 MHz	-54dBm	100 kHz
74 MHz to 87.5 MHz	-36dBm	100 kHz
87.5 MHz to 118 MHz	-54dBm	100 kHz
118 MHz to 174 MHz	-36dBm	100 kHz
174 MHz to 230 MHz	-54dBm	100 kHz
230 MHz to 470 MHz	-36dBm	100 kHz
470 MHz to 694 MHz	-54dBm	100 kHz
694 MHz to 1 GHz	-36dBm	100 kHz
1 GHz ~ 12.75 GHz	-30dBm	1 MHz

3.6.2 TEST PROCEDURE

Refer to chapter 5.4.9.2 of ETSI EN 300328 V2.2.2 (2019-07)

Measurement	
<input checked="" type="checkbox"/> Conducted measurement	<input checked="" type="checkbox"/> Radiated measurement

The setting of the Spectrum Analyzer

RBW	100K(<1GHz) / 1M(>1GHz)
VBW	300K(<1GHz) / 3M(>1GHz)

3.6.3 DEVIATION FROM TEST STANDARD

No deviation

3.6.4 TEST SETUP

Radiated measurement:

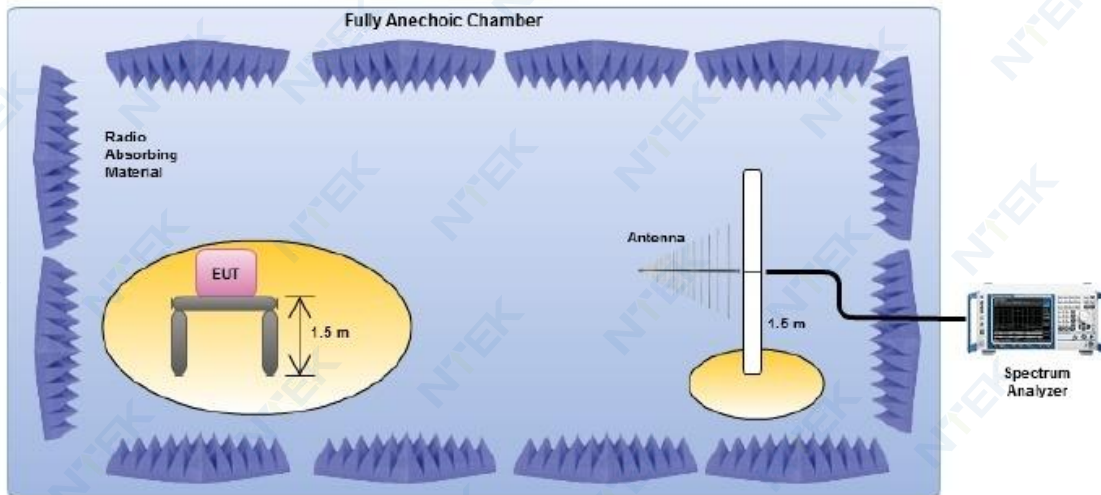

Conducted measurement:



1. For the actual test configuration, please refer to the related Item in this test report (Photographs of the Test Configuration).
2. The measurements were performed when normal hopping was disabled. In this case measurements were performed when operating at the lowest and the highest hopping frequency.
3. The equipment was configured to operate under its worst case situation with respect to output power.
4. The test setup has been constructed as the normal use condition. Controlling software has been activated to set the EUT on specific status.

3.6.5 TEST RESULTS (Radiated measurement)

BELOW 1 GHz WORST- CASE DATA(30 MHz ~ 1GHz)

EUT :	4G Tablet	Model Name :	Tab 80
Temperature :	24°C	Relative Humidity :	57 %
Pressure :	1012 hPa	Test Voltage :	DC 3.85V
Test Mode :	TX-802.11b Mode(CH01)		

Polar (H/V)	Frequency	Meter Reading	Factor	Emission Level	Limits	Margin	Remark
	(MHz)	(dBm)	(dB)	(dBm)	(dBm)	(dB)	
V	35.753	-74.9	10.22	-64.68	-36	-28.68	peak
V	91.051	-75.16	11.07	-64.09	-54	-10.09	peak
V	206.921	-75.86	10.57	-65.29	-54	-11.29	peak
V	464.082	-71.29	11.34	-59.95	-36	-23.95	peak
V	506.092	-72.48	11.42	-61.06	-54	-7.06	peak
H	38.258	-69.98	11.02	-58.96	-36	-22.96	peak
H	117.536	-71.29	9.73	-61.56	-54	-7.56	peak
H	179.279	-71.88	10.82	-61.06	-54	-7.06	peak
H	364.903	-68.05	11.39	-56.66	-36	-20.66	peak
H	518.805	-69.1	9.61	-59.49	-54	-5.49	peak

Remark:

1. Emission Level= Meter Reading+ Factor, Margin= Emission Level- Limit.
2. All the modes had been tested, but only the worst data recorded in the report.

ABOVE 1 GHz WORST- CASE DATA (1GHz ~ 12.75GHz)

EUT :	4G Tablet	Model Name :	Tab 80
Temperature :	26°C	Relative Humidity :	60 %
Pressure :	1012 hPa	Test Voltage :	DC 3.85V
Test Mode :	TX-802.11b Mode(CH01/CH7/CH13)		

Polar (H/V)	Frequency	Meter Reading	Factor	Emission Level	Limits	Margin	Remark
	(MHz)	(dBm)	(dB)	(dBm)	(dBm)	(dB)	
operation frequency:2412							
V	2900.504	-77.35	10.03	-67.32	-30	-37.32	peak
V	4658.471	-67.54	10.14	-57.40	-30	-27.40	peak
V	2639.355	-73.84	10.68	-63.16	-30	-33.16	peak
V	5960.323	-69.42	9.58	-59.84	-30	-29.84	peak
H	2844.637	-69.14	11.39	-57.75	-30	-27.75	peak
H	3175.749	-75.69	9.98	-65.71	-30	-35.71	peak
H	2529.906	-68.82	11.21	-57.61	-30	-27.61	peak
H	5605.102	-73.45	9.93	-63.52	-30	-33.52	peak
operation frequency:2442							
V	2898.903	-73.84	10.83	-63.01	-30	-33.01	peak
V	3245.187	-76.25	11.20	-65.05	-30	-35.05	peak
V	2219.466	-67.8	11.25	-56.55	-30	-26.55	peak
V	4229.147	-68.27	10.45	-57.82	-30	-27.82	peak
H	2327.577	-67.32	11.14	-56.18	-30	-26.18	peak
H	5469.467	-67.64	9.81	-57.83	-30	-27.83	peak
H	2978.997	-76.21	10.20	-66.01	-30	-36.01	peak
H	3687.614	-77.43	11.06	-66.37	-30	-36.37	peak
operation frequency:2472							
V	2031.083	-76.88	10.28	-66.60	-30	-36.60	peak
V	4185.581	-77.68	11.24	-66.44	-30	-36.44	peak
V	2162.273	-72.76	10.06	-62.70	-30	-32.70	peak
V	5312.997	-70.1	9.82	-60.28	-30	-30.28	peak
H	2654.31	-71.79	10.43	-61.36	-30	-31.36	peak
H	5518.519	-68.21	10.31	-57.90	-30	-27.90	peak
H	2272.223	-73.86	10.24	-63.62	-30	-33.62	peak
H	5929.228	-67.46	10.04	-57.42	-30	-27.42	peak

Remark:

1. Emission Level= Meter Reading+ Factor, Margin= Emission Level- Limit.
2. All the modes had been tested, but only the worst data recorded in the report.

3.6.6 TEST RESULTS (Conducted measurement)

Test data reference attachment

3.7. RECEIVER SPURIOUS RADIATION

3.7.1 LIMITS OF RECEIVER SPURIOUS RADIATION

Refer to chapter 4.3.2.10.3 of ETSI EN 300 328 V2.2.2 (2019-07))

RECEIVER SPURIOUS EMISSIONS		
Frequency Range	Maximum Power Limit (E.R.P.(≤1 GHz) E.I.R.P.(> 1 GHz))	Measurement Bandwidth
30 MHz ~ 1 GHz	-57dBm	100KHz
1 GHz ~ 12.75 GHz	-47dBm	1MHz

3.7.2 TEST PROCEDURE

Refer to chapter 5.4.10.2 of ETSI EN 300 328 V2.2.2 (2019-07)

Measurement	
<input checked="" type="checkbox"/> Conducted measurement	<input checked="" type="checkbox"/> Radiated measurement

The setting of the Spectrum Analyzer

RBW	100K(<1GHz) / 1M(>1GHz)
VBW	300K(<1GHz) / 3M(>1GHz)

3.7.3 DEVIATION FROM TEST STANDARD

No deviation

3.7.4 TEST SETUP

Radiated measurement:

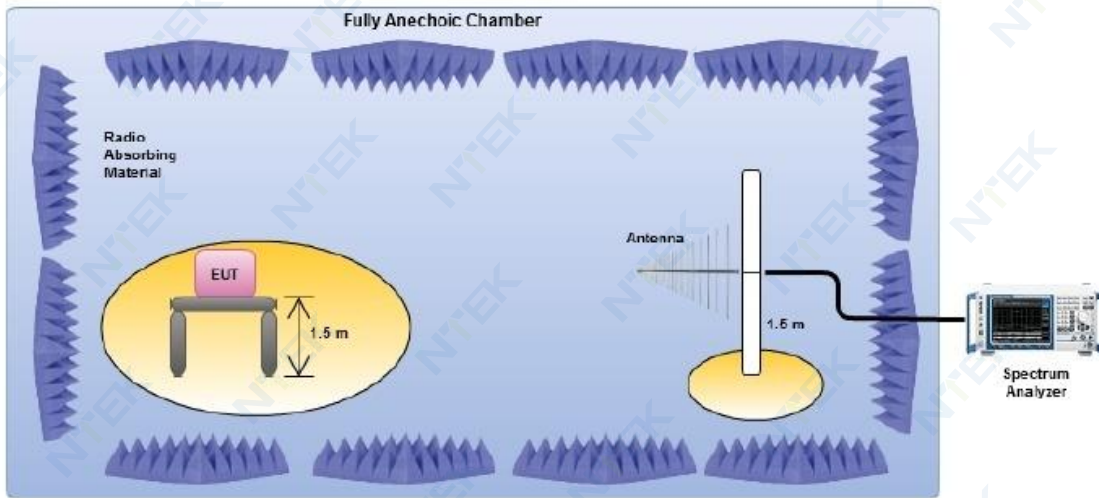

Conducted measurement:

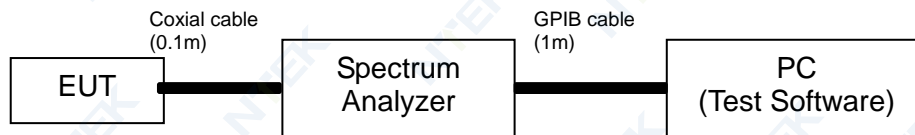

1. For the actual test configuration, please refer to the related Item in this test report (Photographs of the Test Configuration).
2. Testing was performed when the equipment was in a receive-only mode.
3. The measurements were performed when normal hopping was disabled. In this case measurements were performed when operating at the lowest and the highest hopping frequency.
4. The test setup has been constructed as the normal use condition. Controlling software has been activated to set the EUT on specific status.

3.7.5 TEST RESULTS (Radiated measurement)

RX BELOW 1 GHz WORST- CASE DATA(30 MHz ~ 1GHz)

EUT :	4G Tablet	Model Name :	Tab 80
Temperature :	24°C	Relative Humidity :	57 %
Pressure :	1012 hPa	Test Voltage :	DC 3.85V
Test Mode :	RX Mode-802.11b Mode(CH01)		

Polar (H/V)	Frequency	Meter Reading	Factor	Emission Level	Limits	Margin	Remark
	(MHz)	(dBm)	(dB)	(dBm)	(dBm)	(dB)	
V	46.826	-81.67	12.08	-69.59	-57	-12.59	peak
V	98.555	-80.29	13.07	-67.22	-57	-10.22	peak
V	213.503	-81.9	18.00	-63.90	-57	-6.90	peak
V	376.441	-77.04	10.67	-66.37	-57	-9.37	peak
V	580.075	-84.75	16.33	-68.42	-57	-11.42	peak
H	40.299	-82.48	12.04	-70.44	-57	-13.44	peak
H	92.131	-84.23	15.37	-68.86	-57	-11.86	peak
H	229.428	-84.75	16.22	-68.53	-57	-11.53	peak
H	465.811	-81.56	14.43	-67.13	-57	-10.13	peak
H	488.786	-81.75	16.42	-65.33	-57	-8.33	peak

Remark:

1. Emission Level= Meter Reading+ Factor, Margin= Emission Level- Limit.
2. All the modes had been tested, but only the worst data recorded in the report.

RX ABOVE 1 GHz WORST- CASE DATA(1GHz ~ 12.75GHz)

EUT :	4G Tablet	Model Name :	Tab 80
Temperature :	24 °C	Relative Humidity	57%
Pressure :	1010 hPa	Test Power :	DC 3.85V
Test Mode :	RX Mode-802.11b Mode(CH01)		

Polar (H/V)	Frequency	Meter Reading	Factor	Emission Level	Limits	Margin	Remark
	(MHz)	(dBm)	(dB)	(dBm)	(dBm)	(dB)	
V	2998.149	-79.01	11.33	-67.68	-47	-20.68	peak
V	4466.932	-80.41	10.97	-69.44	-47	-22.44	peak
V	2390.386	-80.18	10.14	-70.04	-47	-23.04	peak
V	4052.753	-77.22	16.83	-60.39	-47	-13.39	peak
H	2499.395	-80.07	10.52	-69.55	-47	-22.55	peak
H	5940.462	-84.77	11.70	-73.07	-47	-26.07	peak
H	2183.002	-80.06	6.62	-73.44	-47	-26.44	peak
H	5480.224	-84.3	14.99	-69.31	-47	-22.31	peak

1. Emission Level= Meter Reading+ Factor, Margin= Emission Level- Limit.
2. All the modes had been tested, but only the worst data recorded in the report.

3.7.6 TEST RESULTS (Conducted measurement)

Test data reference attachment

3.8. RECEIVER BLOCKING

3.8.1 PERFORMANCE CRITERIA

The minimum performance criterion shall be a PER less than or equal to 10 %. The manufacturer may declare alternative performance criteria as long as that is appropriate for the intended use of the equipment (see clause 5.4.1.t)).

3.8.2 LIMITS OF RECEIVER BLOCKING

While maintaining the minimum performance criteria as defined in clause 4.3.2.11.3, the blocking levels at specified frequency offsets shall be equal to or greater than the limits defined for the applicable receiver category provided in table 14, table 15 or table 16.

Table 14: Receiver Blocking parameters for Receiver Category 1 equipment

Wanted signal mean power from companion device (dBm) (see notes 1 and 4)	Blocking signal Frequency (MHz)	Blocking signal power (dBm) (see note 4)	Type of blocking signal
(-133 dBm + 10 × log ₁₀ (OCBW)) or -68 dBm whichever is less (see note 2)	2 380 2 504	-34	CW
(-139 dBm + 10 × log ₁₀ (OCBW)) or -74 dBm whichever is less (see note 3)	2 300 2 330 2 360 2524 2584 2674		

NOTE 1: OCBW is in Hz.

NOTE 2: In case of radiated measurements using a companion device and the level of the wanted signal from the companion device cannot be determined, a relative test may be performed using a wanted signal up to P_{min} + 26 dB where P_{min} is the minimum level of wanted signal required to meet the minimum performance criteria as defined in clause 4.3.1.12.3 in the absence of any blocking signal.

NOTE 3: In case of radiated measurements using a companion device and the level of the wanted signal from the companion device cannot be determined, a relative test may be performed using a wanted signal up to P_{min} + 20 dB where P_{min} is the minimum level of wanted signal required to meet the minimum performance criteria as defined in clause 4.3.1.12.3 in the absence of any blocking signal.

NOTE 4: The level specified is the level at the UUT receiver input assuming a 0 dBi antenna assembly gain. In case of conducted measurements, this level has to be corrected for the (in-band) antenna assembly gain (G). In case of radiated measurements, this level is equivalent to a power flux density (PFD) in front of the UUT antenna with the UUT being configured/positioned as recorded in clause 5.4.3.2.2.

Table 15: Receiver Blocking parameters receiver category 2 equipment

Wanted signal mean power from companion device (dBm) (see notes 1 and 3)	Blocking signal Frequency (MHz)	Blocking signal power (dBm) (see note 3)	Type of blocking signal
(-139 dBm + 10 × log ₁₀ (OCBW) + 10 dB) or (-74 dBm + 10 dB) whichever is less (see note 2)	2 380	-34	CW
	2 504		
	2 300		
	2 584		

NOTE 1: OCBW is in Hz.

NOTE 2: In case of radiated measurements using a companion device and the level of the wanted signal from the companion device cannot be determined, a relative test may be performed using a wanted signal up to P_{min} + 26 dB where P_{min} is the minimum level of wanted signal required to meet the minimum performance criteria as defined in clause 4.3.1.12.3 in the absence of any blocking signal.

NOTE 3: The level specified is the level at the UUT receiver input assuming a 0 dBi antenna assembly gain. In case of conducted measurements, this level has to be corrected for the (in-band) antenna assembly gain (G). In case of radiated measurements, this level is equivalent to a power flux density (PFD) in front of the UUT antenna with the UUT being configured/positioned as recorded in clause 5.4.3.2.2.

Table 16: Receiver Blocking parameters receiver category 3 equipment

Wanted signal mean power from companion device (dBm)	Blocking signal Frequency (MHz)	Blocking signal power (dBm) (see note 2)	Type of blocking signal
(-139 dBm + 10 × log ₁₀ (OCBW) + 20 dB) or (-74 dBm + 20 dB) whichever is less (see note 2)	2 380	-34	CW
	2 504		
	2 300		
	2 584		

NOTE 1: OCBW is in Hz.

NOTE 2: In case of radiated measurements using a companion device and the level of the wanted signal from the companion device cannot be determined, a relative the test may be performed using a wanted signal up to P_{min} + 30 dB where P_{min} is the minimum level of wanted signal required to meet the minimum performance criteria as defined in clause 4.3.1.12.3 in the absence of any blocking signal.

NOTE 3: The level specified is the level at the UUT receiver input assuming a 0 dBi antenna assembly gain. In case of conducted measurements, this level has to be corrected for the (in-band) antenna assembly gain (G). In case of radiated measurements, this level is equivalent to a power flux density (PFD) in front of the UUT antenna with the UUT being configured/positioned as recorded in clause 5.4.3.2.2.

3.8.3 TEST PROCEDURE

Refer to chapter 5.4.11.2 of ETSI EN 300 328 V2.2.2 (2019-07)

Measurement	
<input checked="" type="checkbox"/> Conducted measurement	<input type="checkbox"/> Radiated measurement

3.8.4 DEVIATION FROM TEST STANDARD

No deviation

3.8.5 TEST SETUP

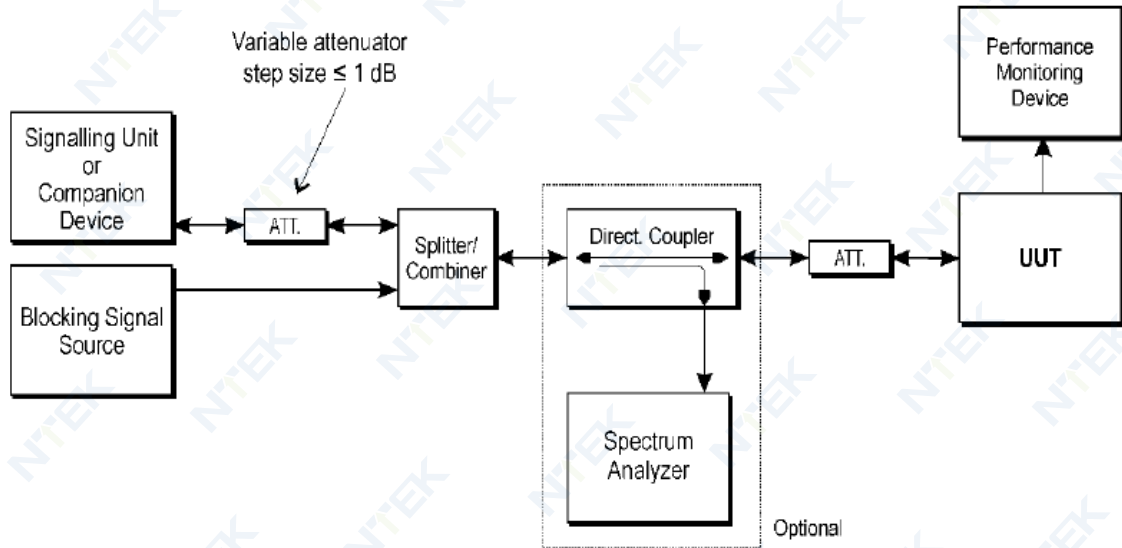

3.8.6 TEST RESULTS

EUT :	4G Tablet	Model Name :	Tab 80
Temperature :	26°C	Relative Humidity :	60 %
Pressure :	1012 hPa	Test Voltage :	DC 3.85V
Test Mode :	RX Mode(802.11b-CH01/CH13)		

CH01:

receiver category 1

Wanted signal mean power from companion device (dBm) ^{Note(1)}	Blocking signal Frequency (MHz)	Blocking signal power (dBm)	PER %	PER Limit %
-68	2380	-34	0.85%	≤10%
	2504		0.68%	
-74	2300		0.47%	≤10%
	2330		0.33%	
	2360		0.15%	
	2524		0.89%	
	2584		0.30%	
	2674		0.60%	

CH13:

receiver category 1

Wanted signal mean power from companion device (dBm) ^{Note(1)}	Blocking signal Frequency (MHz)	Blocking signal power (dBm)	PER %	PER Limit %
-68	2380	-34	0.78%	≤10%
	2504		0.37%	
-74	2300		0.92%	≤10%
	2330		0.52%	
	2360		0.46%	
	2524		0.46%	
	2584		0.26%	
	2674		0.89%	

Note: (1) The above results were obtained from laboratory tests.

EUT :	4G Tablet	Model Name :	Tab 80
Temperature :	26°C	Relative Humidity :	60 %
Pressure :	1012 hPa	Test Voltage :	DC 3.85V
Test Mode :	RX Mode(802.11g-CH01/CH13)		

CH01:

receiver category 1

Wanted signal mean power from companion device (dBm) _{Note(1)}	Blocking signal Frequency (MHz)	Blocking signal power (dBm)	PER %	PER Limit %
-68	2380	-34	0.87%	≤10%
	2504		0.37%	
-74	2300		0.40%	≤10%
	2330		0.39%	
	2360		0.99%	
	2524		0.21%	
	2584		0.43%	
	2674		0.86%	

CH13:

receiver category 1

Wanted signal mean power from companion device (dBm) _{Note(1)}	Blocking signal Frequency (MHz)	Blocking signal power (dBm)	PER %	PER Limit %
-68	2380	-34	0.11%	≤10%
	2504		0.98%	
-74	2300		0.95%	≤10%
	2330		0.16%	
	2360		0.30%	
	2524		0.01%	
	2584		0.69%	
	2674		0.69%	

Note: (1) The above results were obtained from laboratory tests.

EUT :	4G Tablet	Model Name :	Tab 80
Temperature :	26°C	Relative Humidity :	60 %
Pressure :	1012 hPa	Test Voltage :	DC 3.85V
Test Mode :	RX Mode(802.11n20-CH01/CH13)		

CH01:

receiver category 1

Wanted signal mean power from companion device (dBm) _{Note(1)}	Blocking signal Frequency (MHz)	Blocking signal power (dBm)	PER %	PER Limit %
-68	2380		0.06%	≤10%
	2504		0.38%	
-74	2300	-34	0.05%	≤10%
	2330		0.48%	
	2360		0.72%	
	2524		0.09%	
	2584		0.57%	
	2674		0.46%	

CH13:

receiver category 1

Wanted signal mean power from companion device (dBm) _{Note(1)}	Blocking signal Frequency (MHz)	Blocking signal power (dBm)	PER %	PER Limit %
-68	2380		0.17%	≤10%
	2504		0.49%	
-74	2300	-34	0.19%	≤10%
	2330		0.71%	
	2360		0.54%	
	2524		0.22%	
	2584		0.63%	
	2674		0.56%	

Note: (1) The above results were obtained from laboratory tests.

EUT :	4G Tablet	Model Name :	Tab 80
Temperature :	26°C	Relative Humidity :	60 %
Pressure :	1012 hPa	Test Voltage :	DC 3.85V
Test Mode :	RX Mode(802.11n40-CH03/CH11)		

CH03:

receiver category 1

Wanted signal mean power from companion device (dBm) _{Note(1)}	Blocking signal Frequency (MHz)	Blocking signal power (dBm)	PER %	PER Limit %
-68	2380	-34	0.82%	≤10%
	2504		0.27%	
-74	2300		0.17%	≤10%
	2330		0.16%	
	2360		0.12%	
	2524		0.83%	
	2584		0.73%	
	2674		0.08%	

CH11:

receiver category 1

Wanted signal mean power from companion device (dBm) _{Note(1)}	Blocking signal Frequency (MHz)	Blocking signal power (dBm)	PER %	PER Limit %
-68	2380	-34	0.26%	≤10%
	2504		0.54%	
-74	2300		0.23%	≤10%
	2330		0.48%	
	2360		0.96%	
	2524		0.10%	
	2584		0.56%	
	2674		0.95%	

Note: (1) The above results were obtained from laboratory tests.

4. TEST RESULTS

4.1 RF Output Power

Condition	Mode	Frequency (MHz)	Max Burst RMS Power (dBm)	Burst Number	Max EIRP (dBm)	Limit (dBm)	Verdict
NVNT	802.11b	2412	16.4	49	18.24	20	Pass
NVNT	802.11b	2442	16.34	49	18.18	20	Pass
NVNT	802.11b	2472	15.75	49	17.59	20	Pass
NVNT	802.11g	2412	13.83	265	15.67	20	Pass
NVNT	802.11g	2442	13.92	258	15.76	20	Pass
NVNT	802.11g	2472	14.3	264	16.14	20	Pass
NVNT	802.11n(HT20)	2412	11.79	232	13.63	20	Pass
NVNT	802.11n(HT20)	2442	11.97	232	13.81	20	Pass
NVNT	802.11n(HT20)	2472	12	232	13.84	20	Pass
NVNT	802.11n(HT40)	2422	10.66	418	12.5	20	Pass
NVNT	802.11n(HT40)	2442	11.4	418	13.24	20	Pass
NVNT	802.11n(HT40)	2462	10.96	417	12.8	20	Pass
NVLT	802.11b	2412	15.84	49	17.68	20	Pass
NVLT	802.11b	2442	16.08	48	17.92	20	Pass
NVLT	802.11b	2472	15.06	48	16.9	20	Pass
NVLT	802.11g	2412	13.27	279	15.11	20	Pass
NVLT	802.11g	2442	13.66	279	15.5	20	Pass
NVLT	802.11g	2472	13.61	349	15.45	20	Pass
NVLT	802.11n(HT20)	2412	11.71	224	13.55	20	Pass
NVLT	802.11n(HT20)	2442	11.28	224	13.12	20	Pass
NVLT	802.11n(HT20)	2472	11.23	224	13.07	20	Pass
NVLT	802.11n(HT40)	2422	10.1	435	11.94	20	Pass
NVLT	802.11n(HT40)	2442	10.4	435	12.24	20	Pass
NVLT	802.11n(HT40)	2462	10.27	434	12.11	20	Pass
NVHT	802.11b	2412	15.89	49	17.73	20	Pass

NVHT	802.11b	2442	15.82	48	17.66	20	Pass
NVHT	802.11b	2472	15.27	48	17.11	20	Pass
NVHT	802.11g	2412	13.43	279	15.27	20	Pass
NVHT	802.11g	2442	13.4	279	15.24	20	Pass
NVHT	802.11g	2472	13.74	349	15.58	20	Pass
NVHT	802.11n(HT20)	2412	11.02	224	12.86	20	Pass
NVHT	802.11n(HT20)	2442	11.47	224	13.31	20	Pass
NVHT	802.11n(HT20)	2472	11.77	224	13.61	20	Pass
NVHT	802.11n(HT40)	2422	10.19	435	12.03	20	Pass
NVHT	802.11n(HT40)	2442	9.84	435	11.68	20	Pass
NVHT	802.11n(HT40)	2462	10.39	434	12.23	20	Pass

Test Graphs

Power NVNT b 2412MHz Ant1

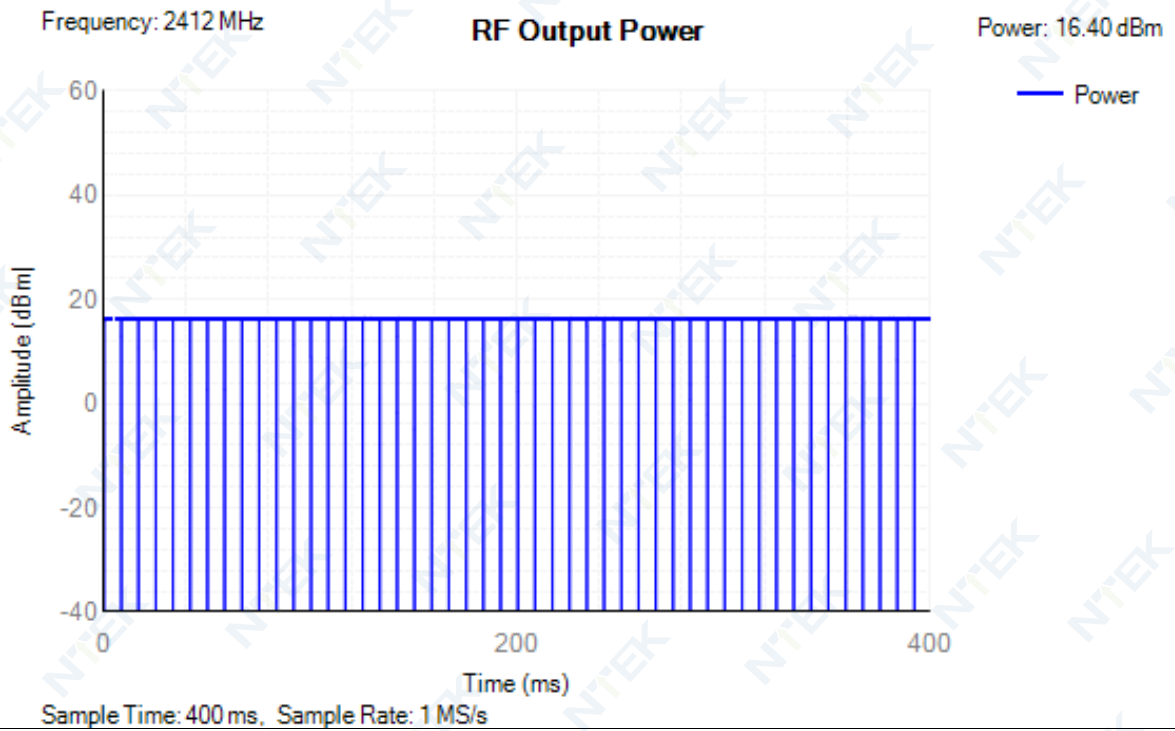

Power NVNT b 2442MHz Ant1

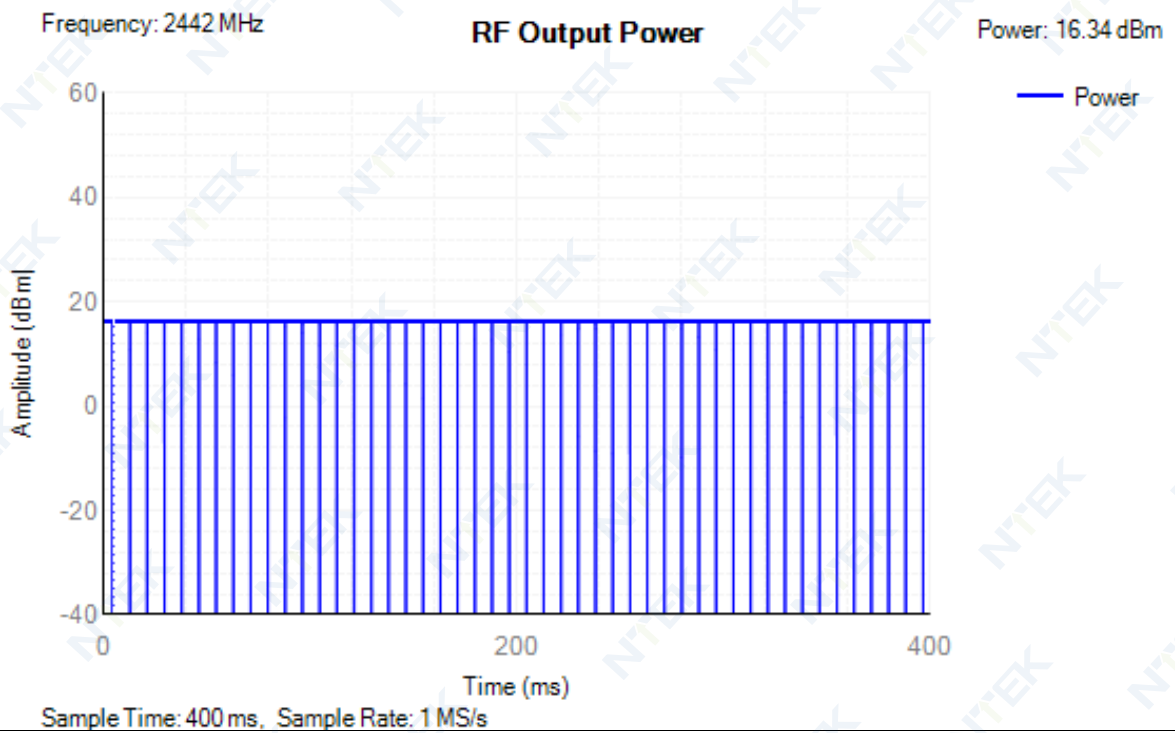

Power NVNT b 2472MHz Ant1

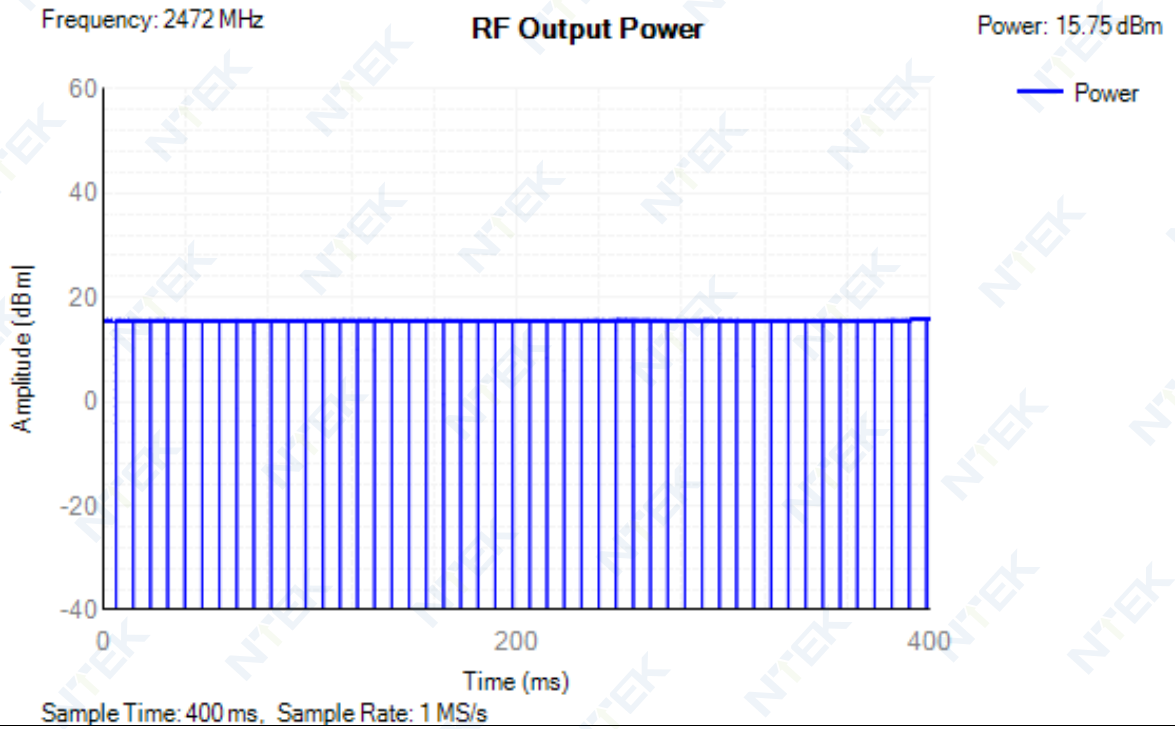

Power NVNT g 2412MHz Ant1

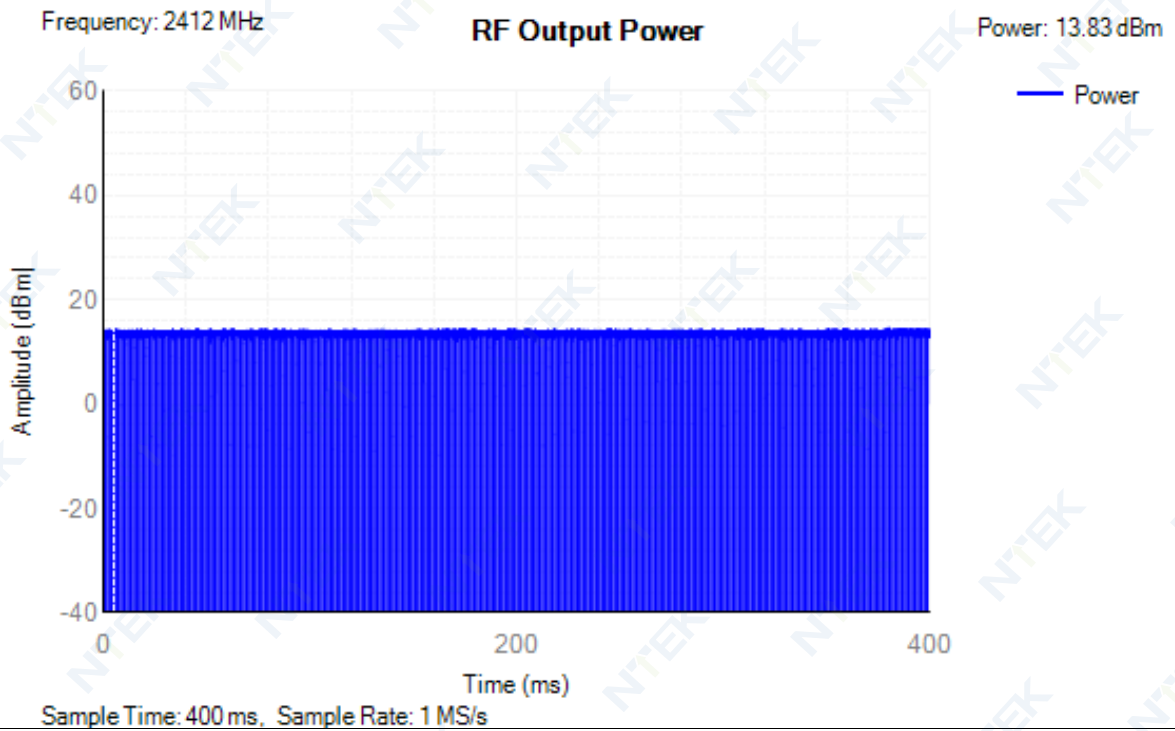

Power NVNT g 2442MHz Ant1

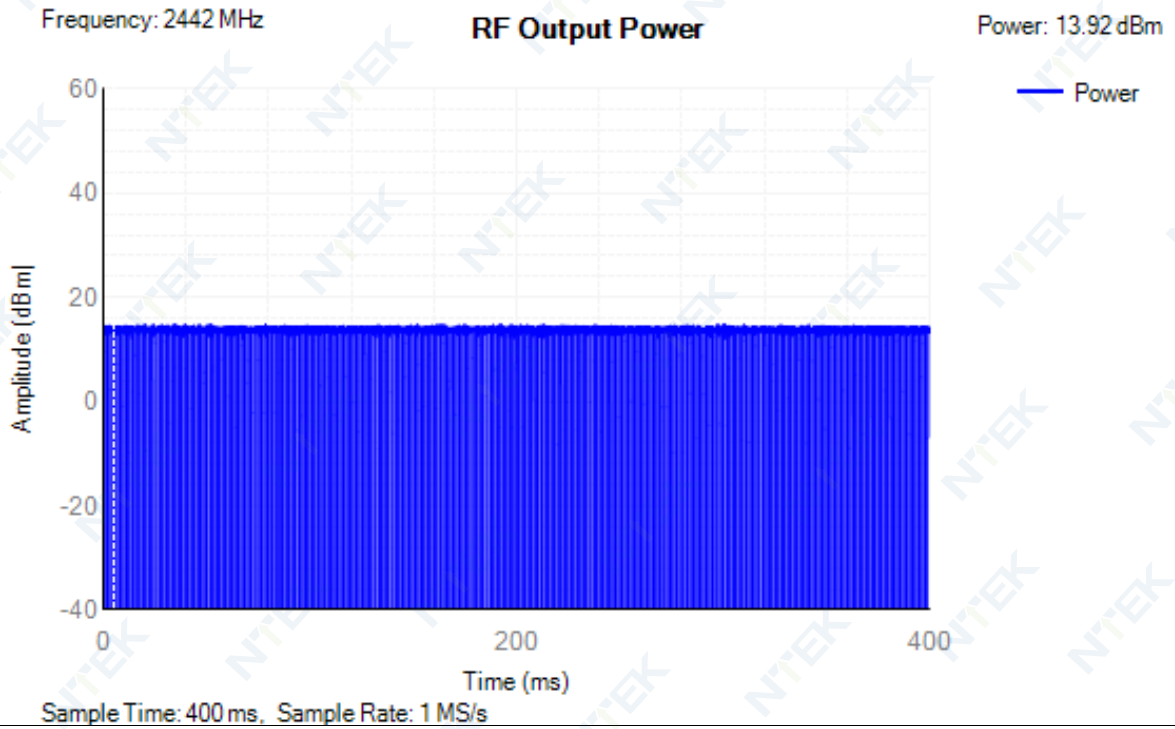

Power NVNT g 2472MHz Ant1

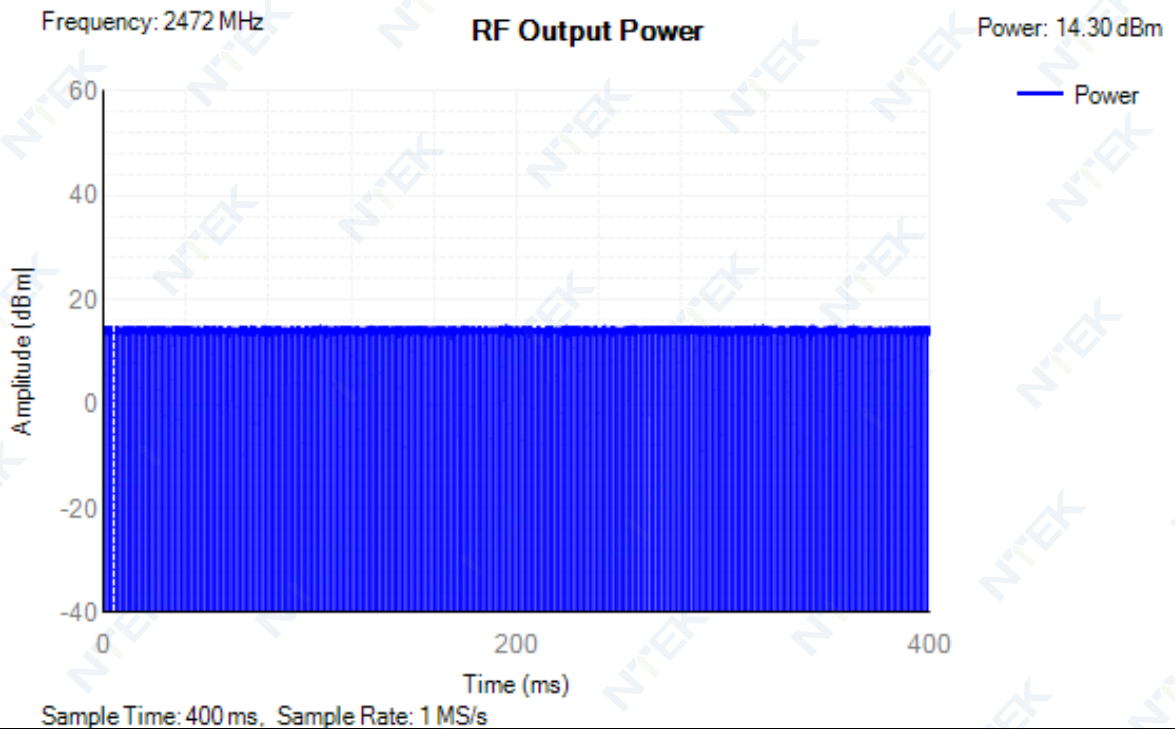

Power NVNT n20 2412MHz Ant1

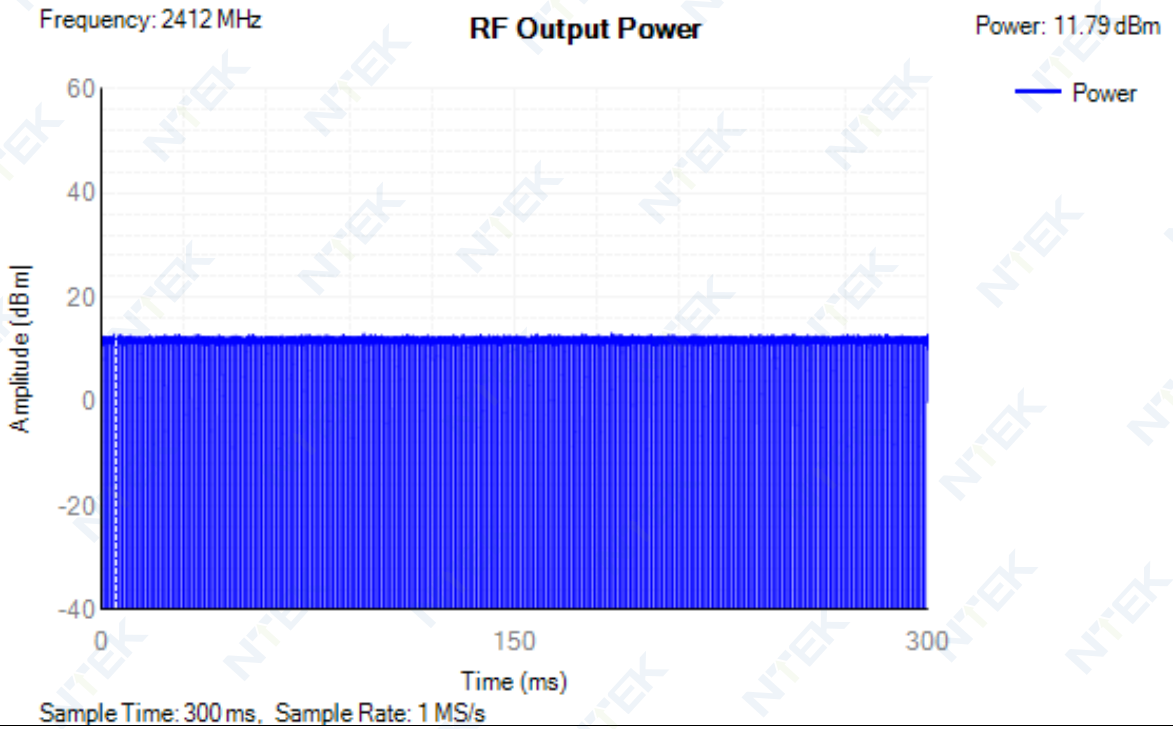

Power NVNT n20 2442MHz Ant1

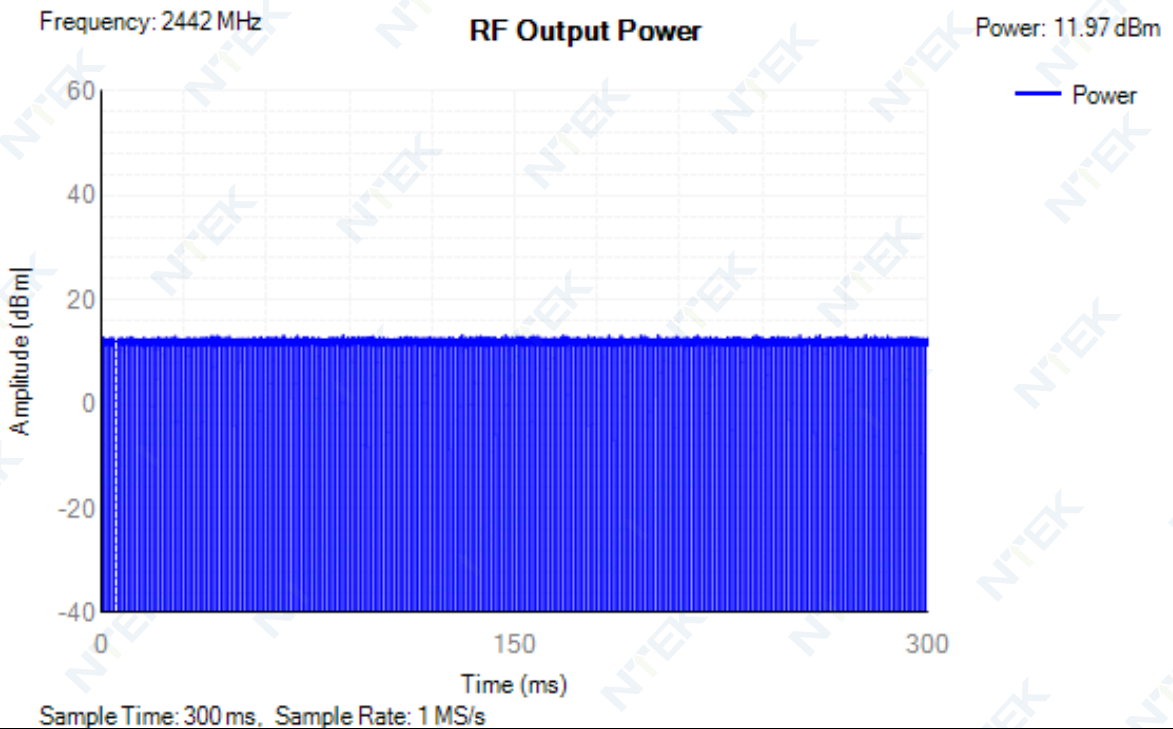

Power NVNT n20 2472MHz Ant1

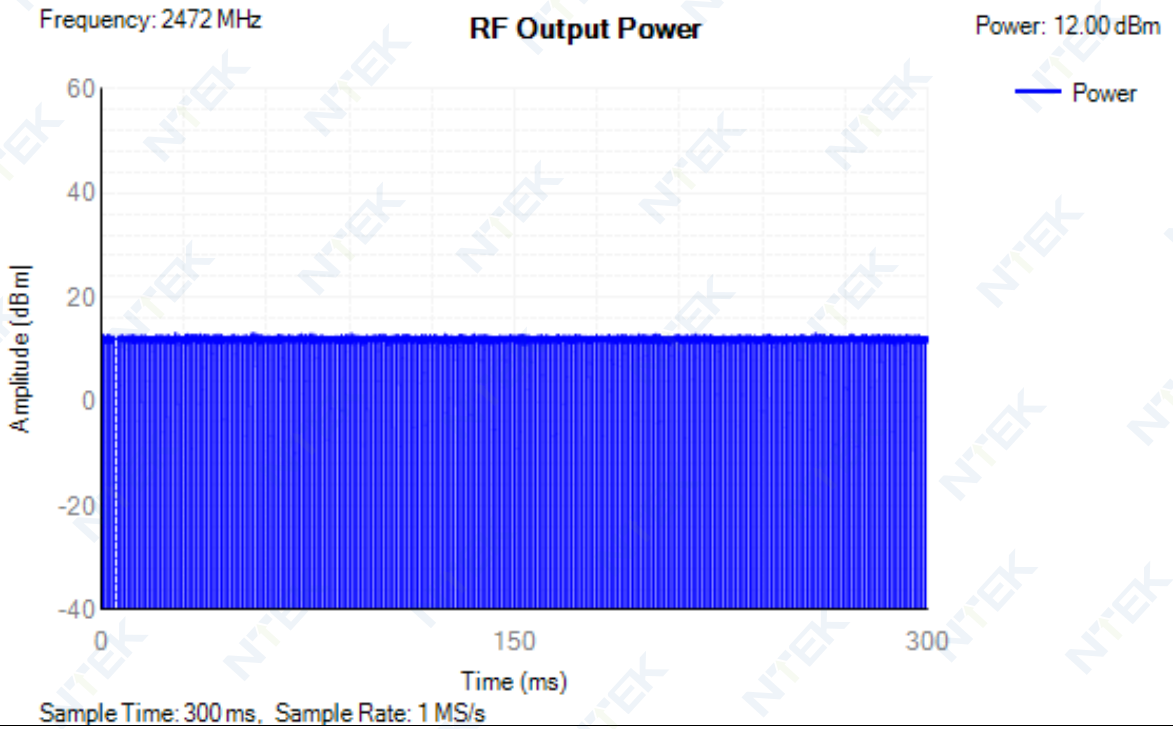

Power NVNT n40 2422MHz Ant1

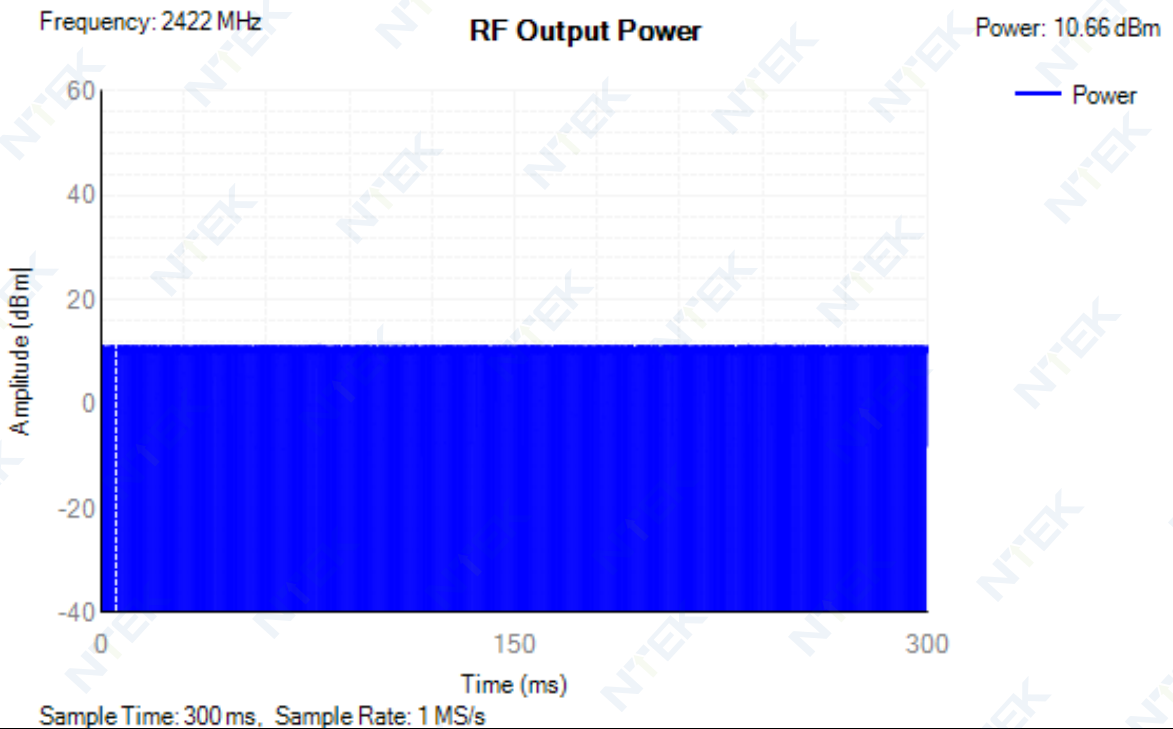

Power NVNT n40 2442MHz Ant1

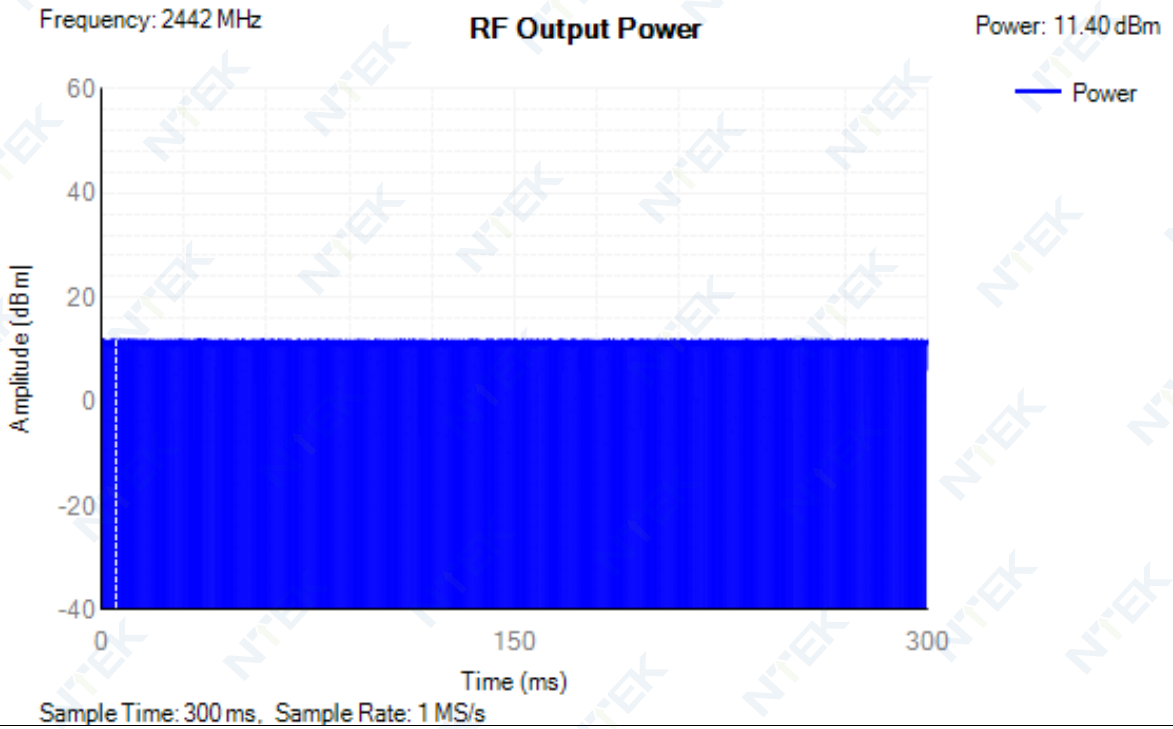

Power NVNT n40 2462MHz Ant1

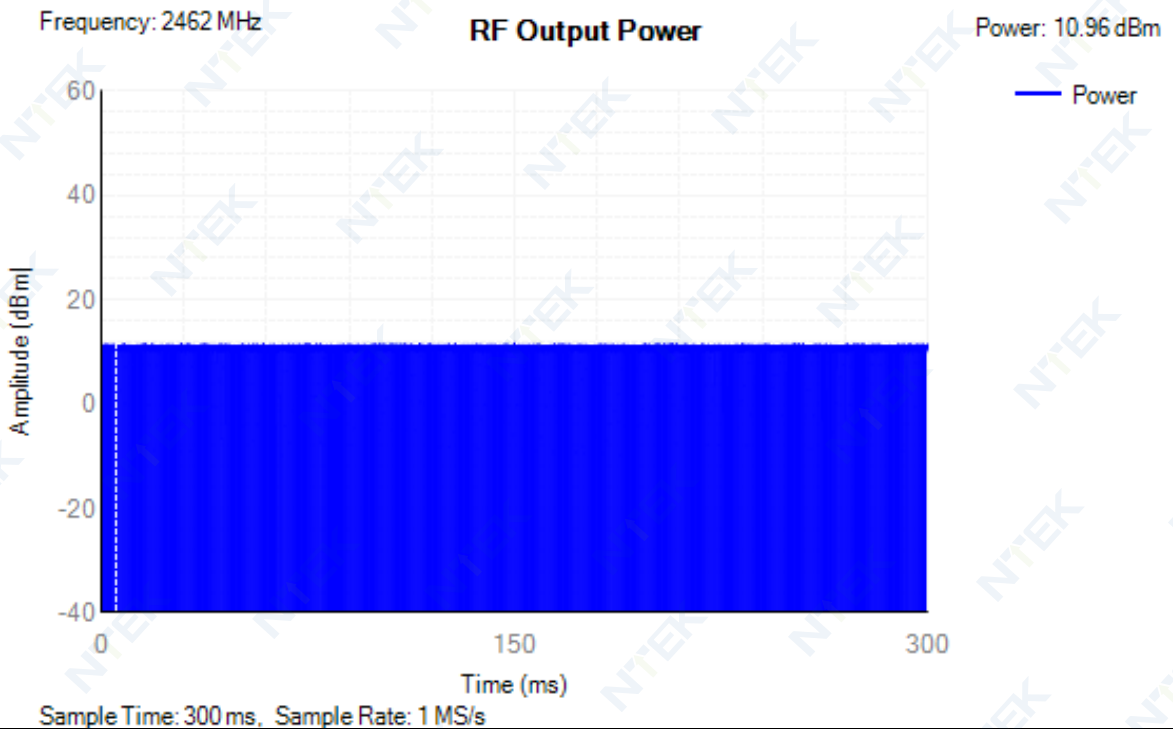

4.2 Power Spectral Density

Condition	Mode	Frequency (MHz)	Antenna	Max PSD (dBm/MHz)	Limit (dBm/MHz)	Verdict
NVNT	b	2412	Ant1	7.32	10	Pass
NVNT	b	2442	Ant1	7.13	10	Pass
NVNT	b	2472	Ant1	6.89	10	Pass
NVNT	g	2412	Ant1	2.13	10	Pass
NVNT	g	2442	Ant1	2	10	Pass
NVNT	g	2472	Ant1	3.31	10	Pass
NVNT	n20	2412	Ant1	-0.12	10	Pass
NVNT	n20	2442	Ant1	-0.22	10	Pass
NVNT	n20	2472	Ant1	0.16	10	Pass
NVNT	n40	2422	Ant1	-3.5	10	Pass
NVNT	n40	2442	Ant1	-2.69	10	Pass
NVNT	n40	2462	Ant1	-3.48	10	Pass

Test Graphs

PSD NVNT b 2412MHz Ant1

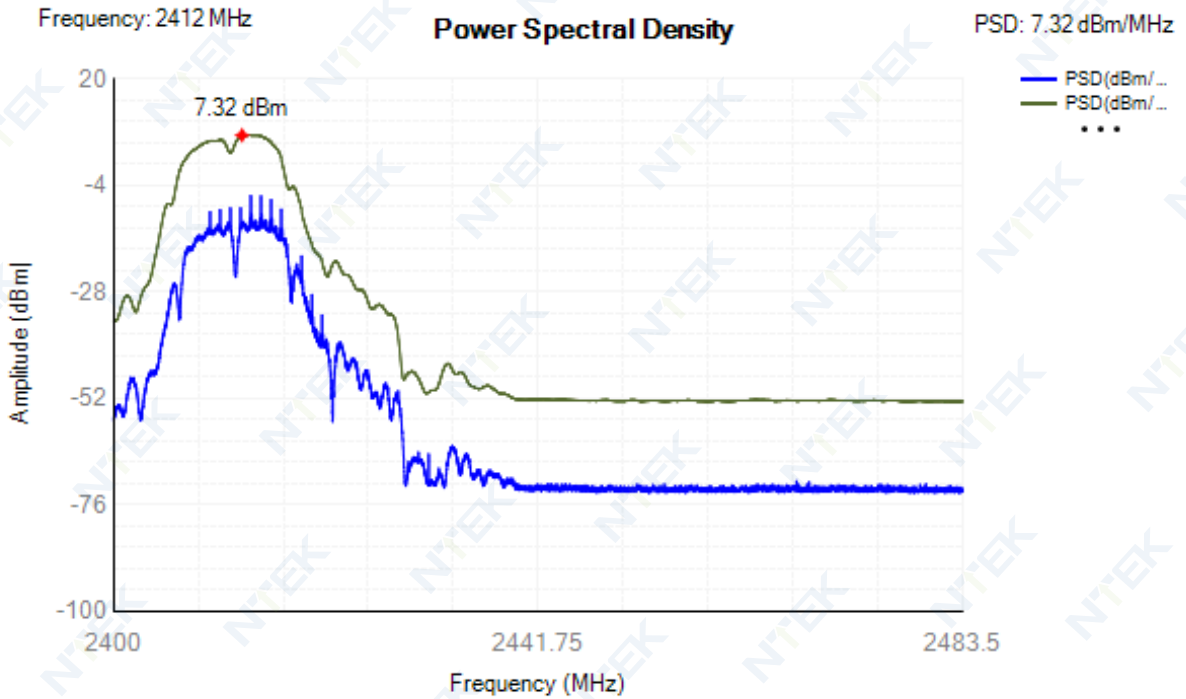

PSD NVNT b 2442MHz Ant1

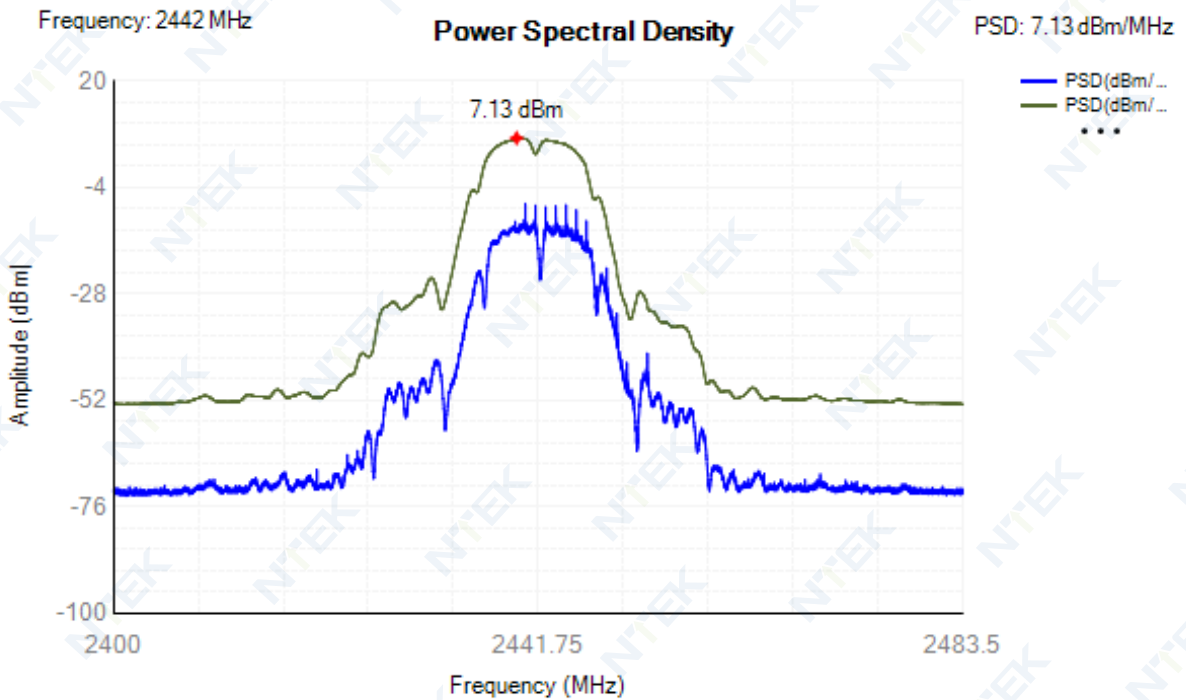

PSD NVNT b 2472MHz Ant1

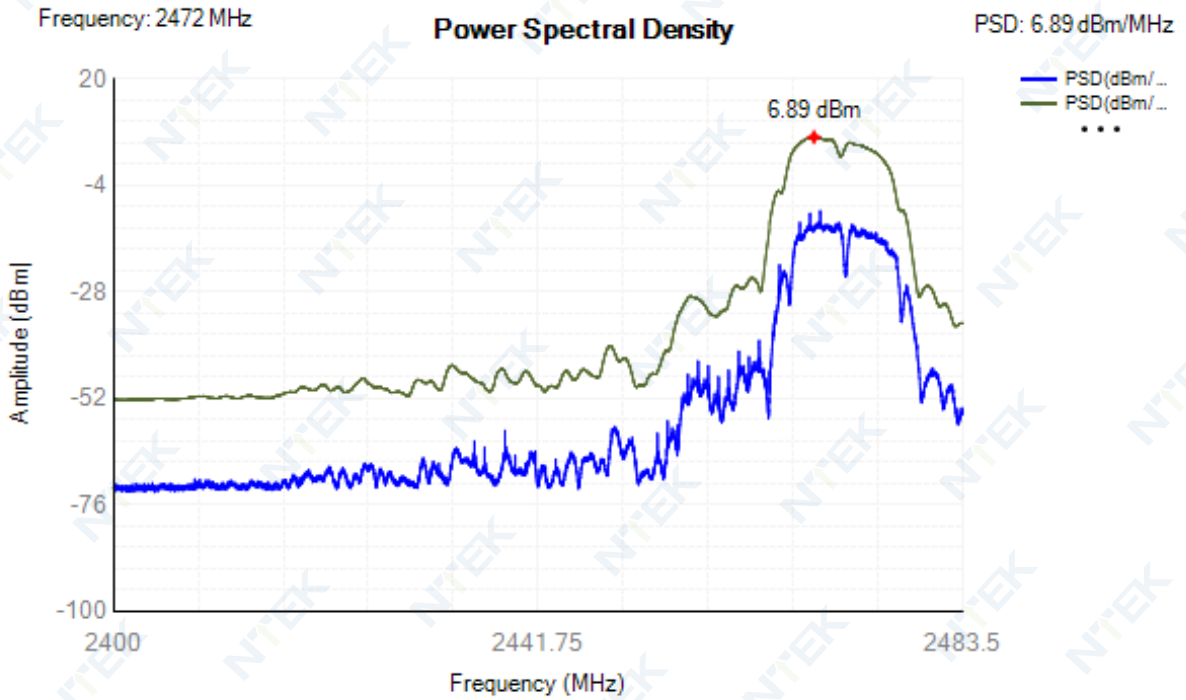

PSD NVNT g 2412MHz Ant1

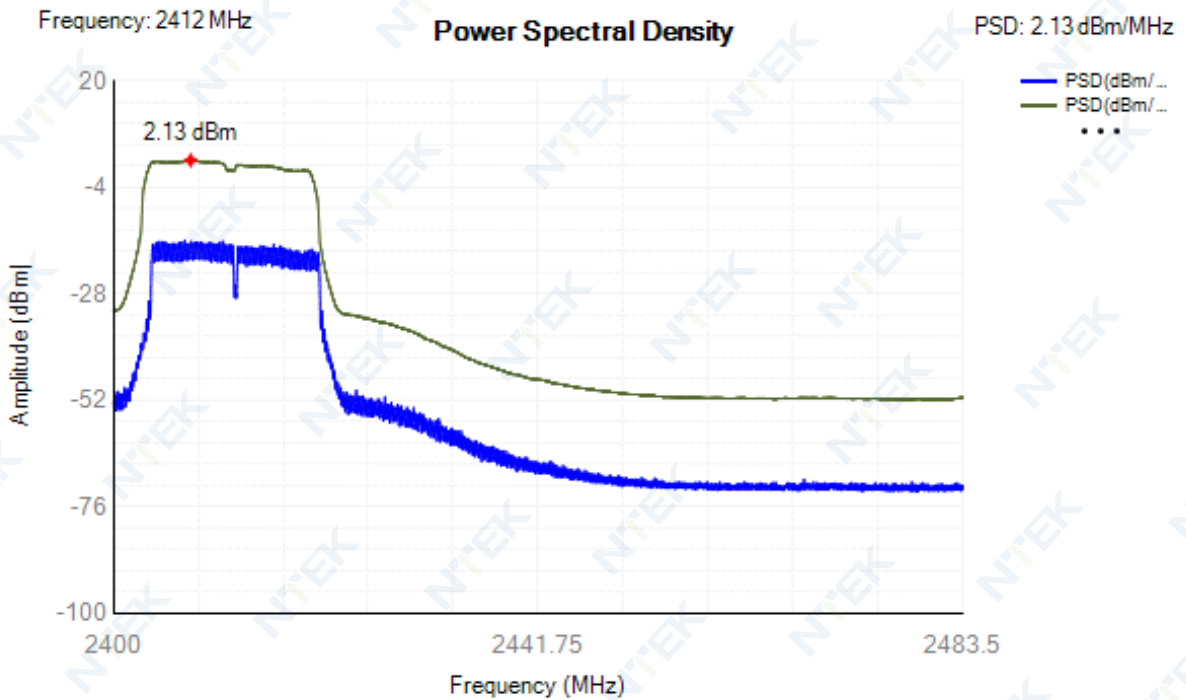

PSD NVNT g 2442MHz Ant1

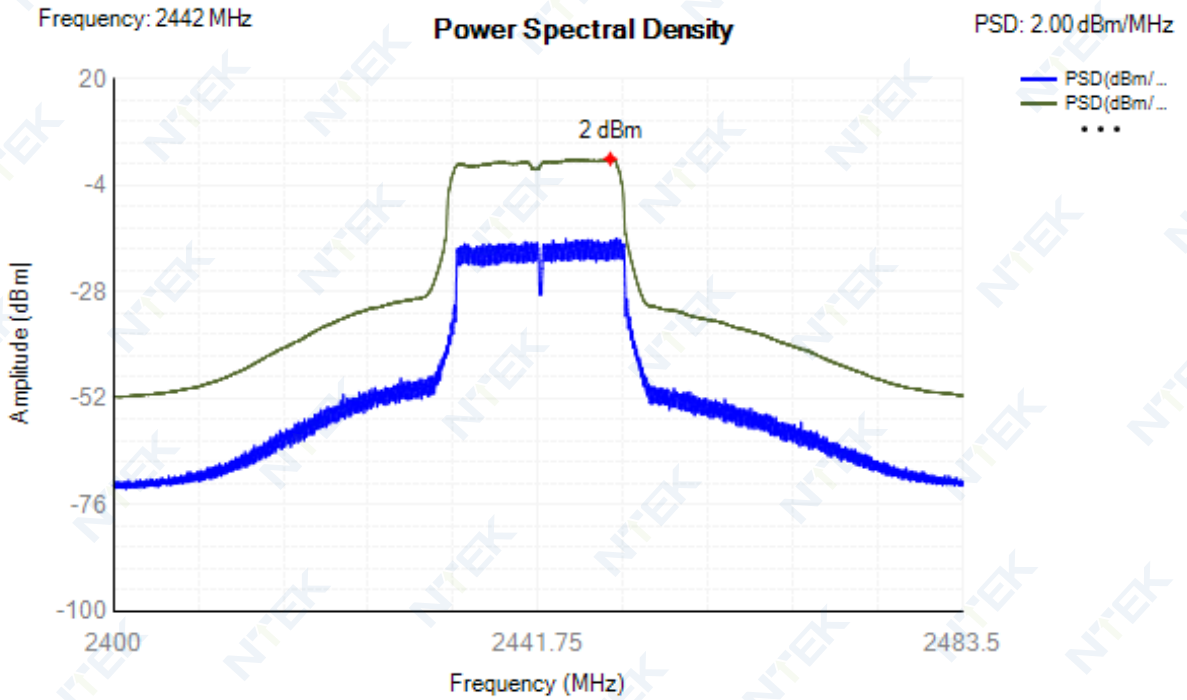

RBW: 10 KHz, VBW: 30 KHz, Sweep Points: 8351

PSD NVNT g 2472MHz Ant1

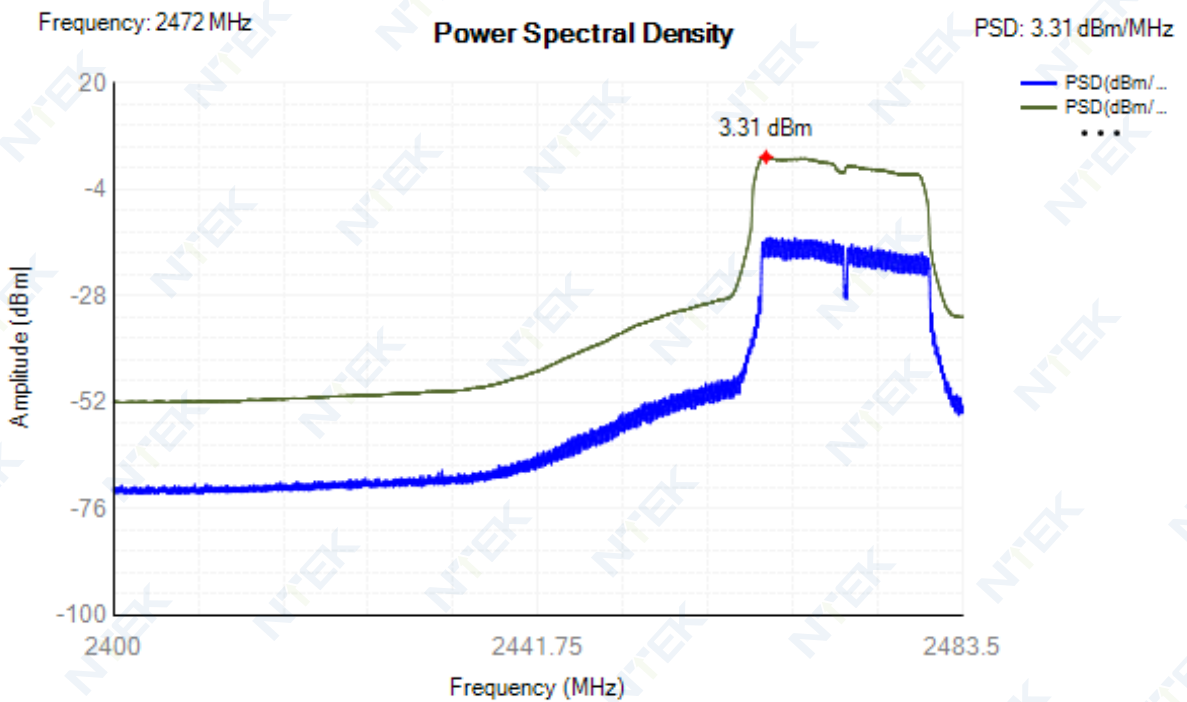

RBW: 10 KHz, VBW: 30 KHz, Sweep Points: 8351

PSD NVNT n20 2412MHz Ant1

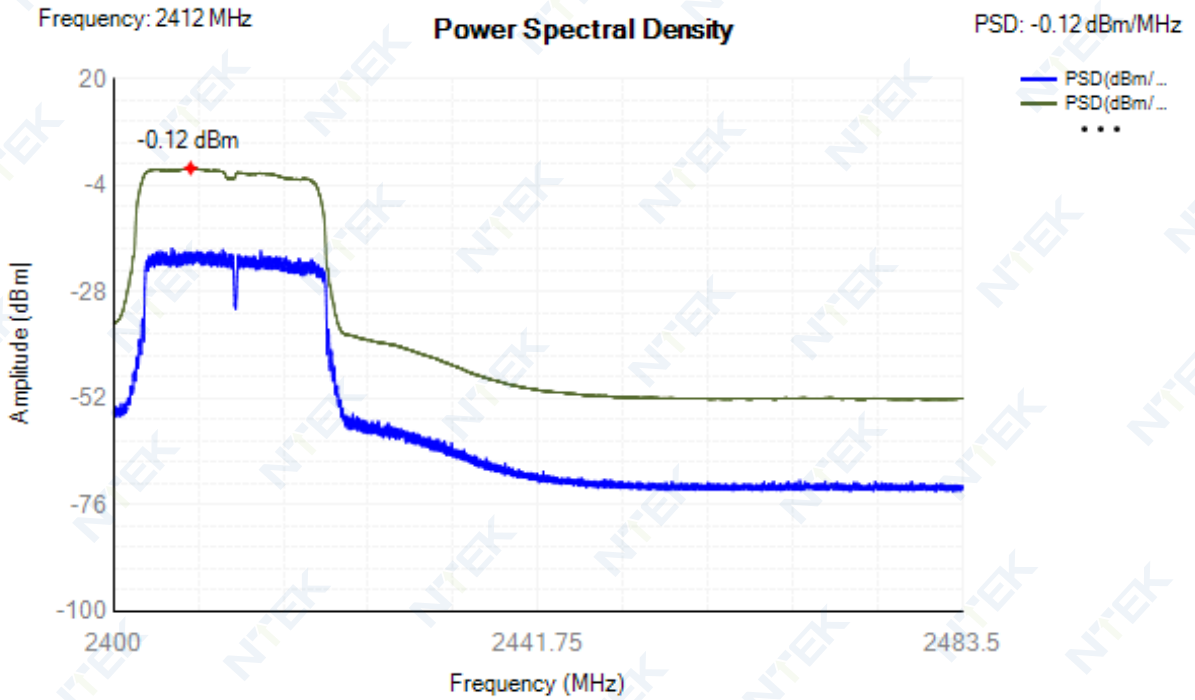

PSD NVNT n20 2442MHz Ant1

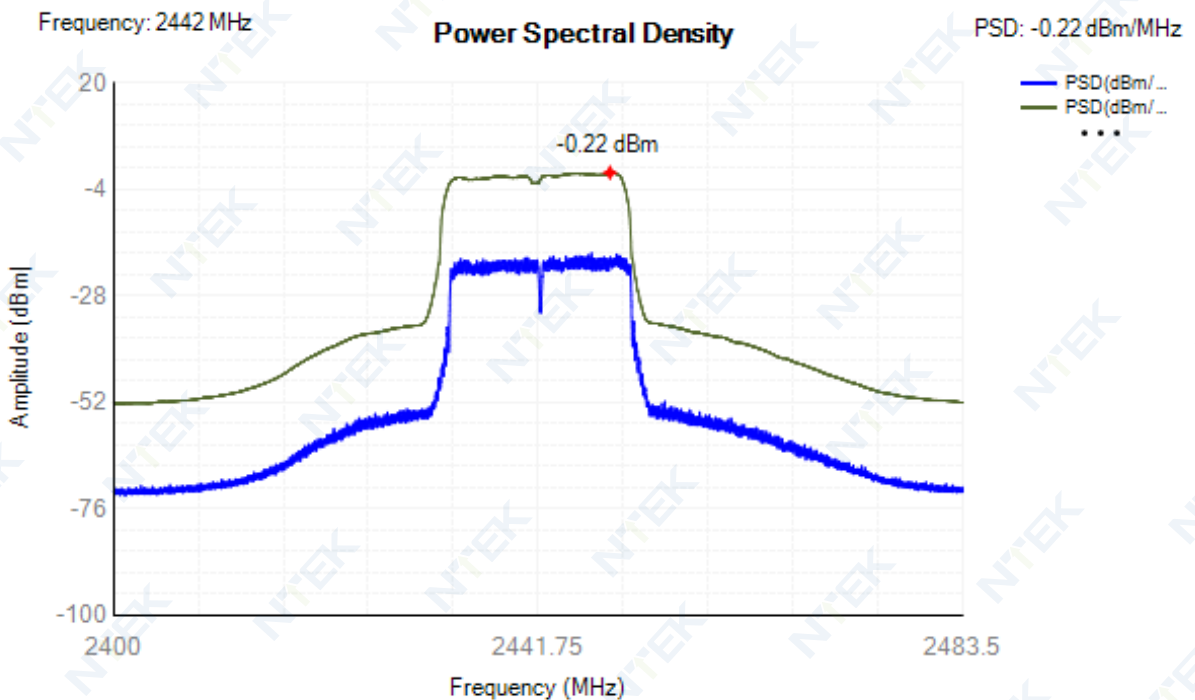

PSD NVNT n20 2472MHz Ant1

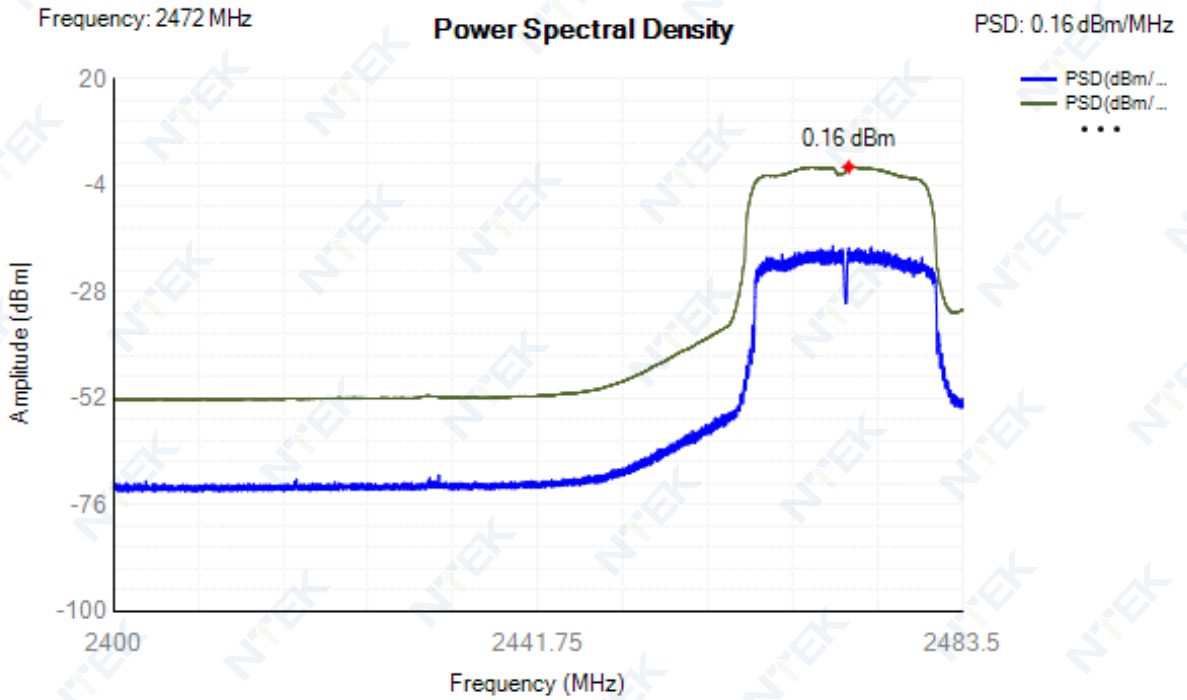

PSD NVNT n40 2422MHz Ant1

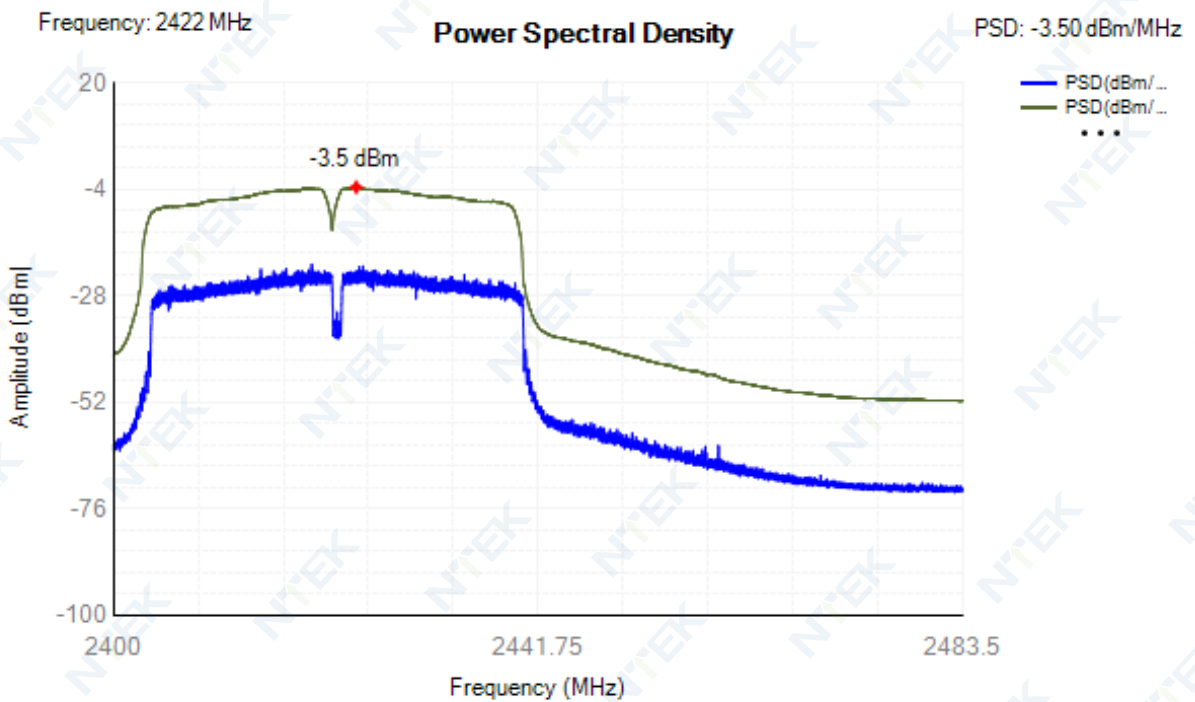

PSD NVNT n40 2442MHz Ant1

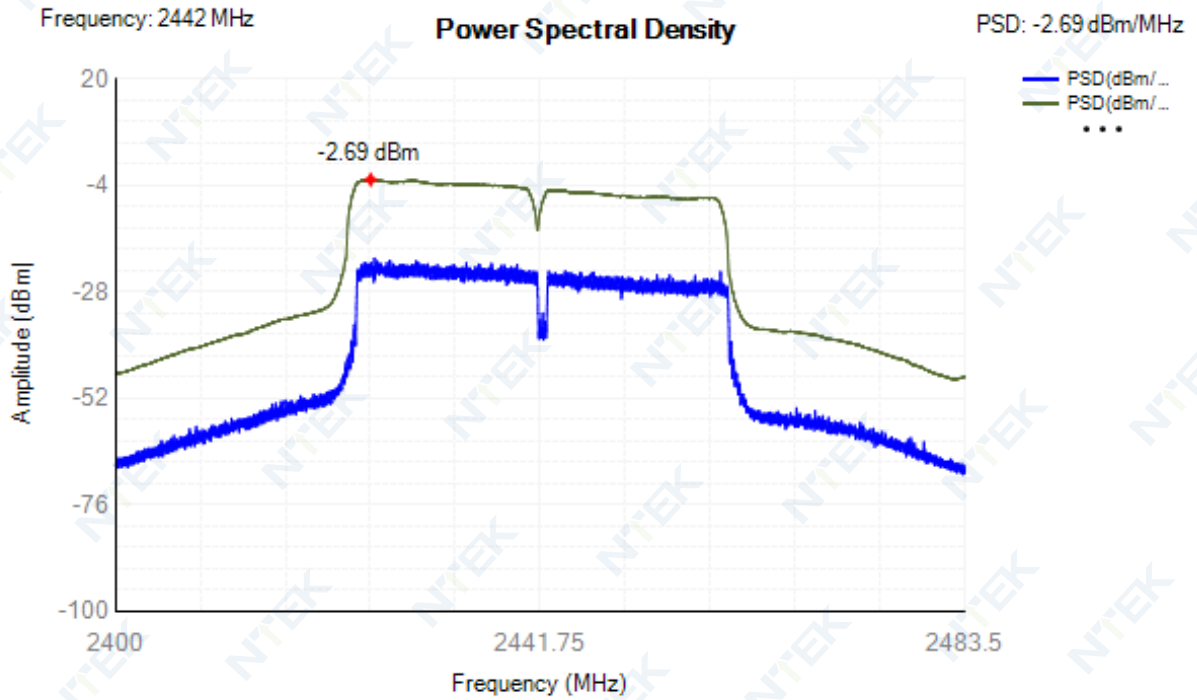

PSD NVNT n40 2462MHz Ant1

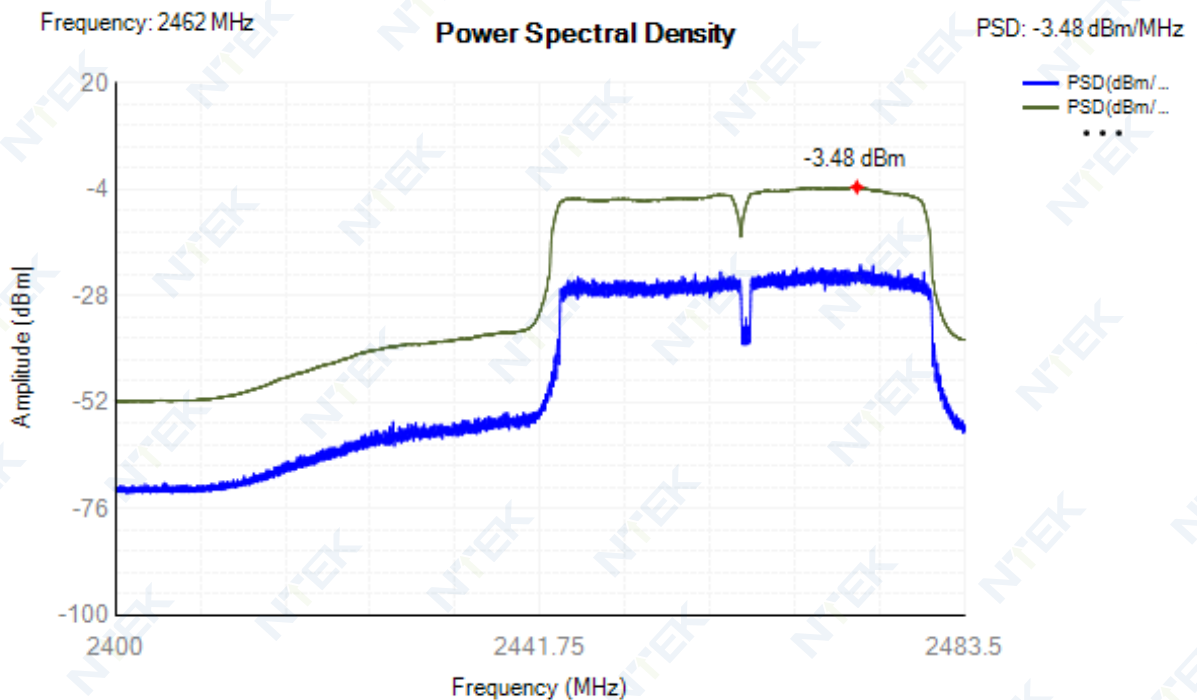

4.3 Occupied Channel Bandwidth

Condition	Mode	Frequency (MHz)	Antenna	Center Frequency (MHz)	OBW (MHz)	Lower Edge (MHz)	Upper Edge (MHz)	Limit OBW (MHz)	Verdict
NVNT	b	2412	Ant1	2412.364	12.071	2406.329	2418.399	2400 - 2483.5MHz	Pass
NVNT	b	2442	Ant1	2441.848	12.343	2435.677	2448.019	2400 - 2483.5MHz	Pass
NVNT	b	2472	Ant1	2471.618	11.435	2465.901	2477.335	2400 - 2483.5MHz	Pass
NVNT	g	2412	Ant1	2411.94	16.614	2403.633	2420.247	2400 - 2483.5MHz	Pass
NVNT	g	2442	Ant1	2442.02	16.686	2433.677	2450.363	2400 - 2483.5MHz	Pass
NVNT	g	2472	Ant1	2471.894	16.626	2463.581	2480.207	2400 - 2483.5MHz	Pass
NVNT	n20	2412	Ant1	2411.93	17.674	2403.093	2420.767	2400 - 2483.5MHz	Pass
NVNT	n20	2442	Ant1	2442.026	17.762	2433.145	2450.907	2400 - 2483.5MHz	Pass
NVNT	n20	2472	Ant1	2471.978	17.514	2463.221	2480.735	2400 - 2483.5MHz	Pass
NVNT	n40	2422	Ant1	2422.06	35.924	2404.098	2440.022	2400 - 2483.5MHz	Pass
NVNT	n40	2442	Ant1	2441.808	36.428	2423.594	2460.022	2400 - 2483.5MHz	Pass
NVNT	n40	2462	Ant1	2461.98	36.276	2443.842	2480.118	2400 - 2483.5MHz	Pass

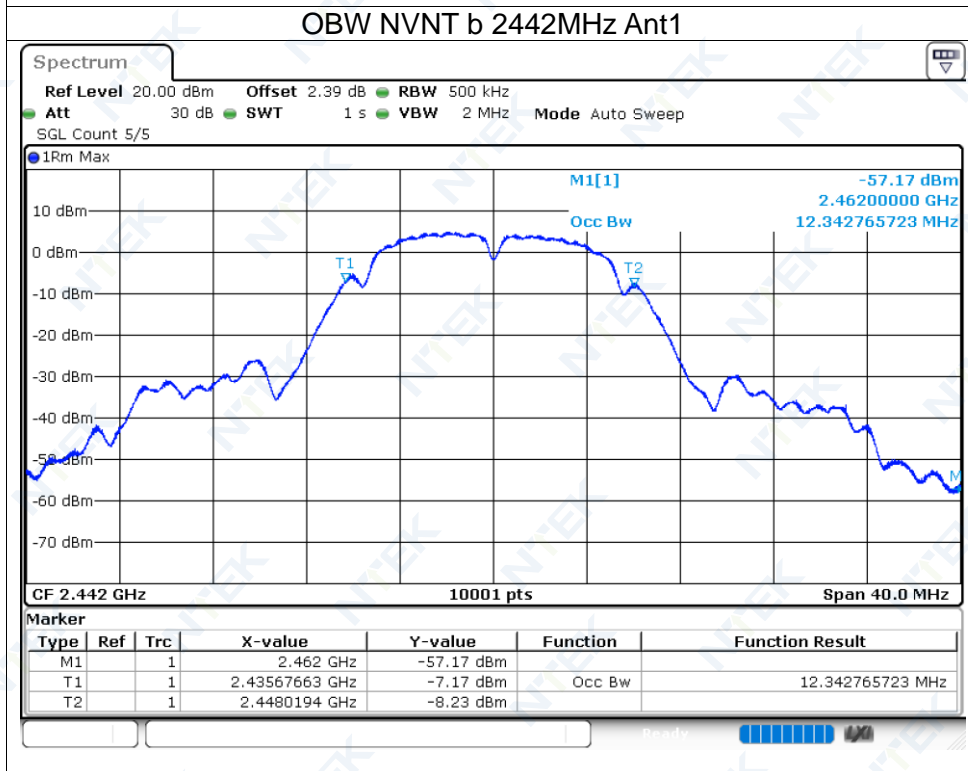
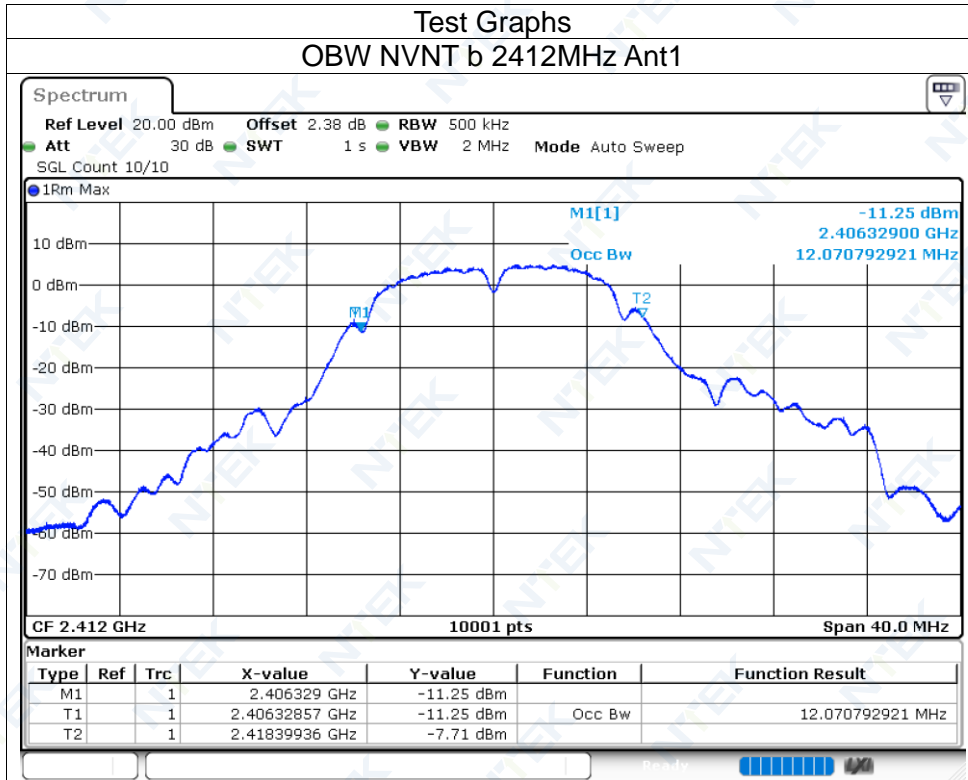

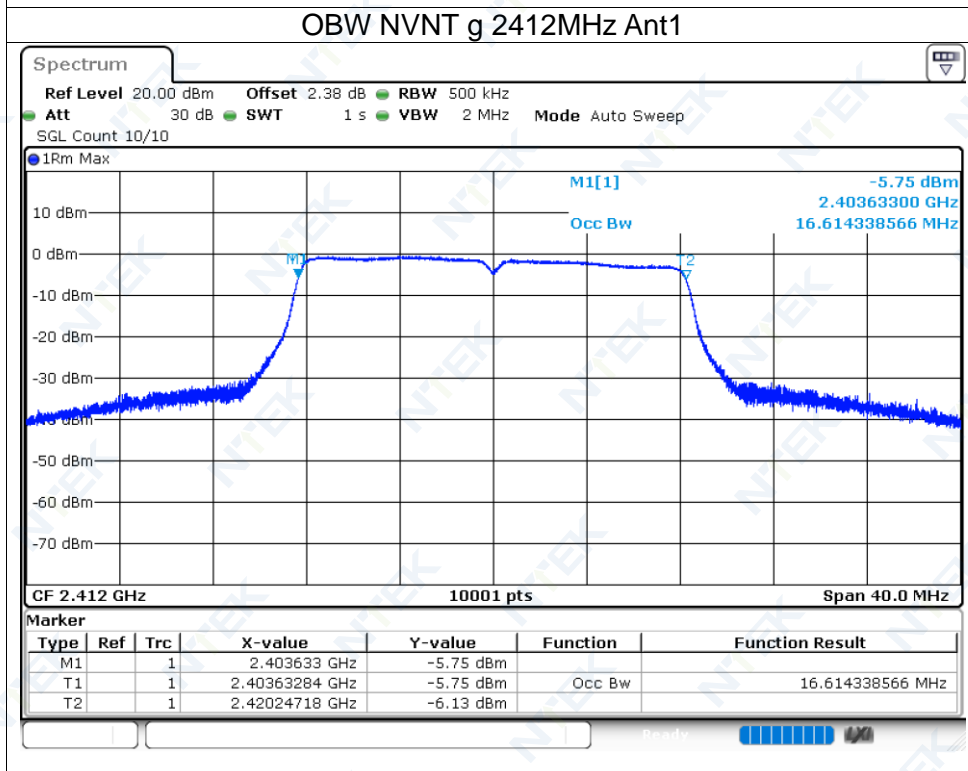
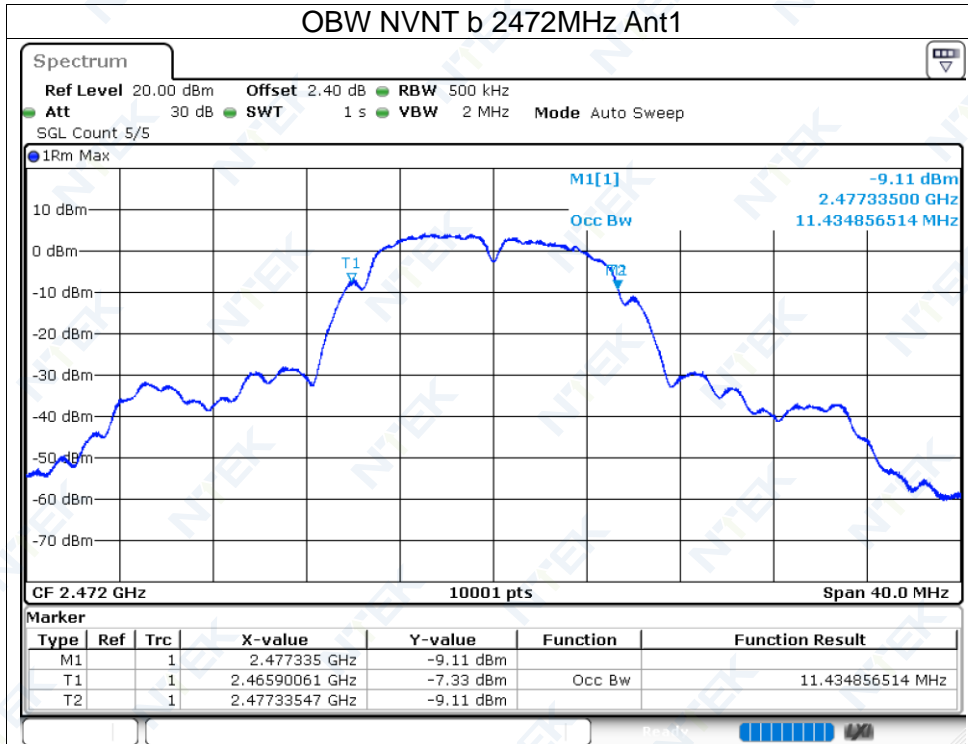

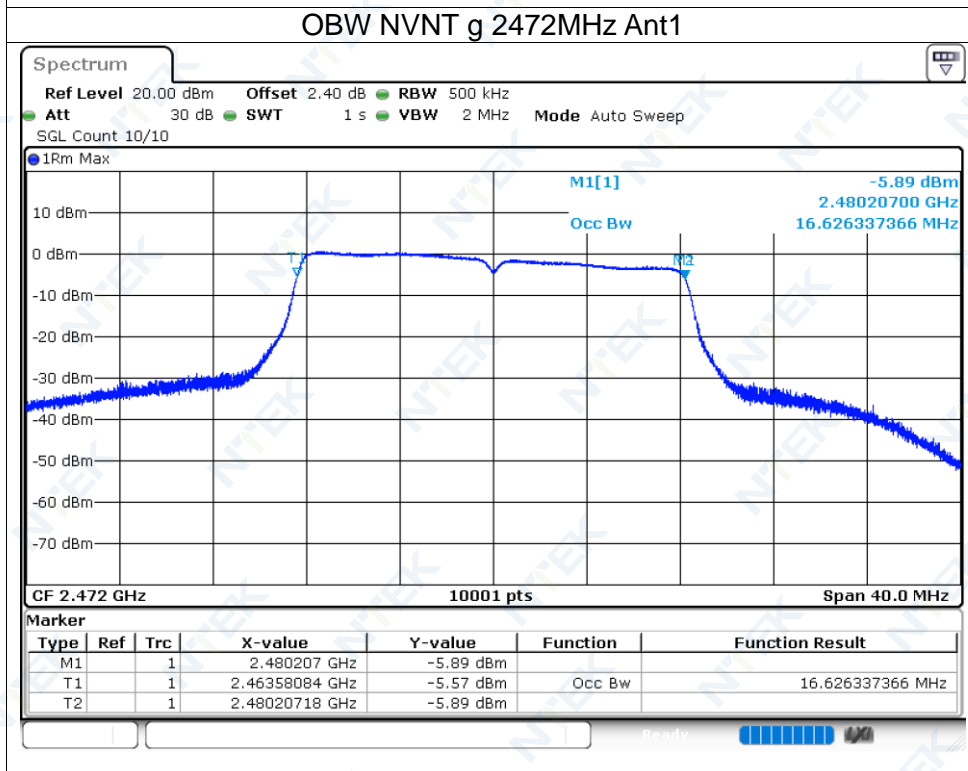
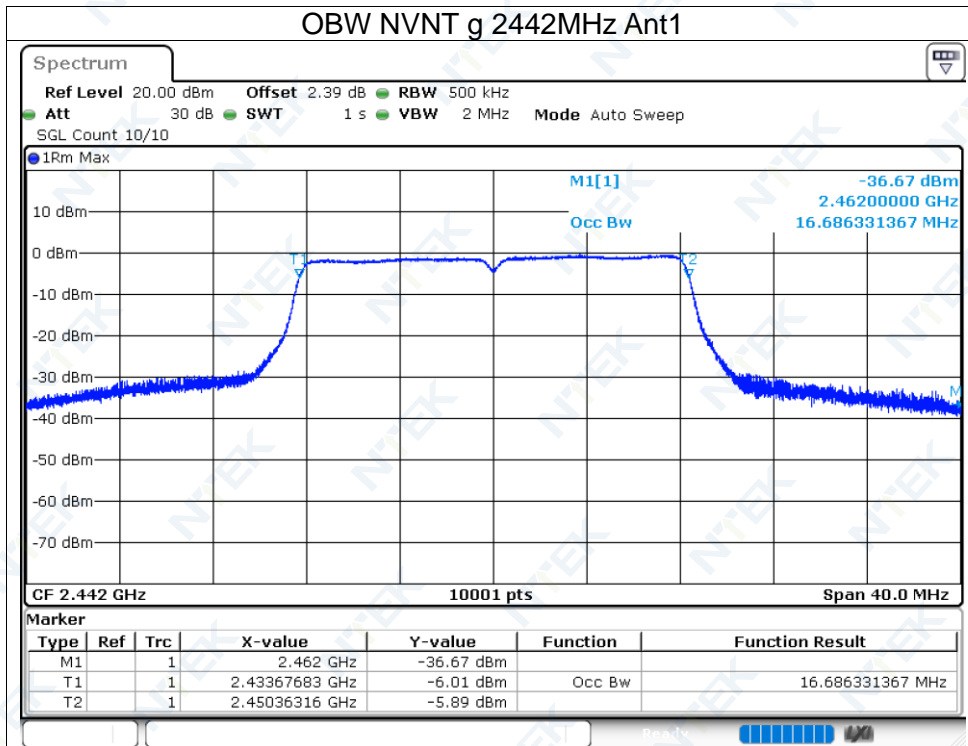

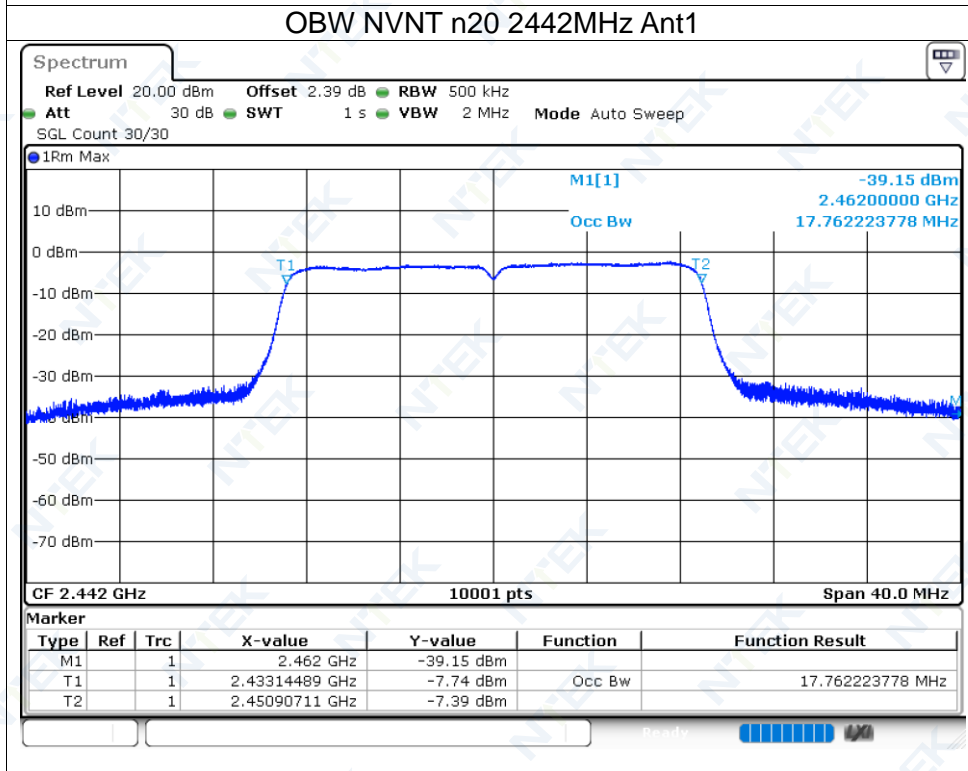
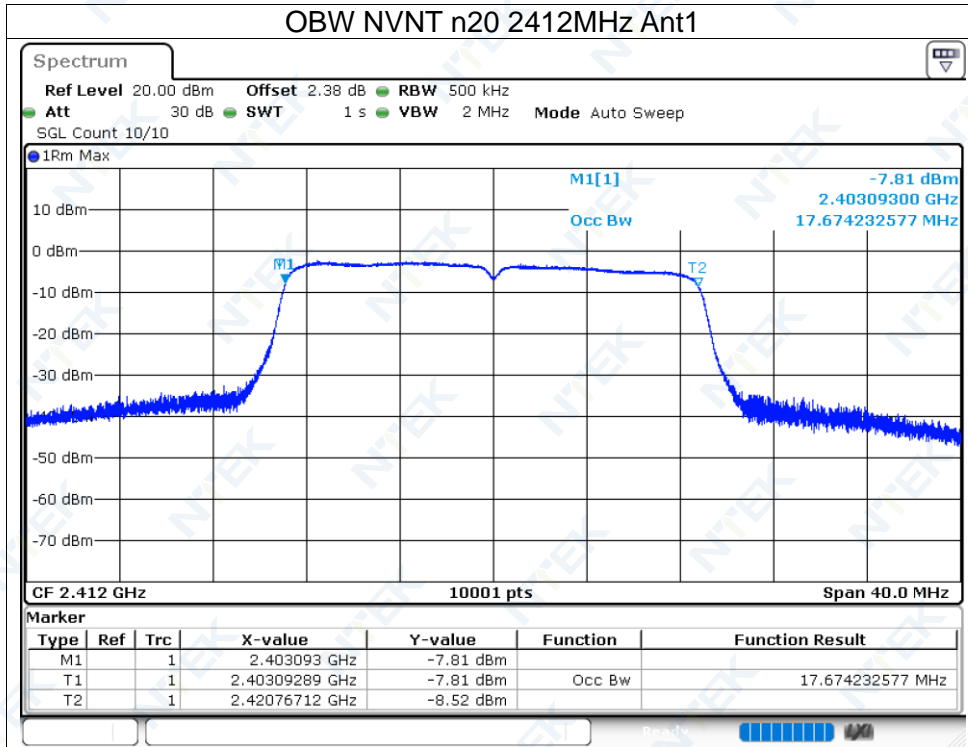

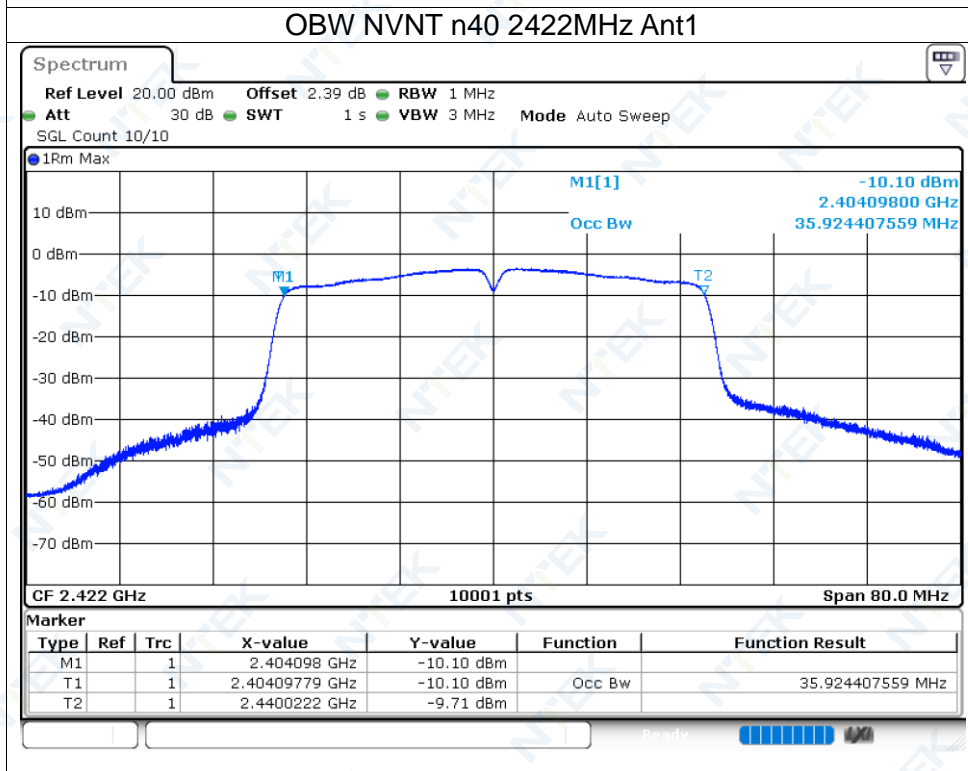
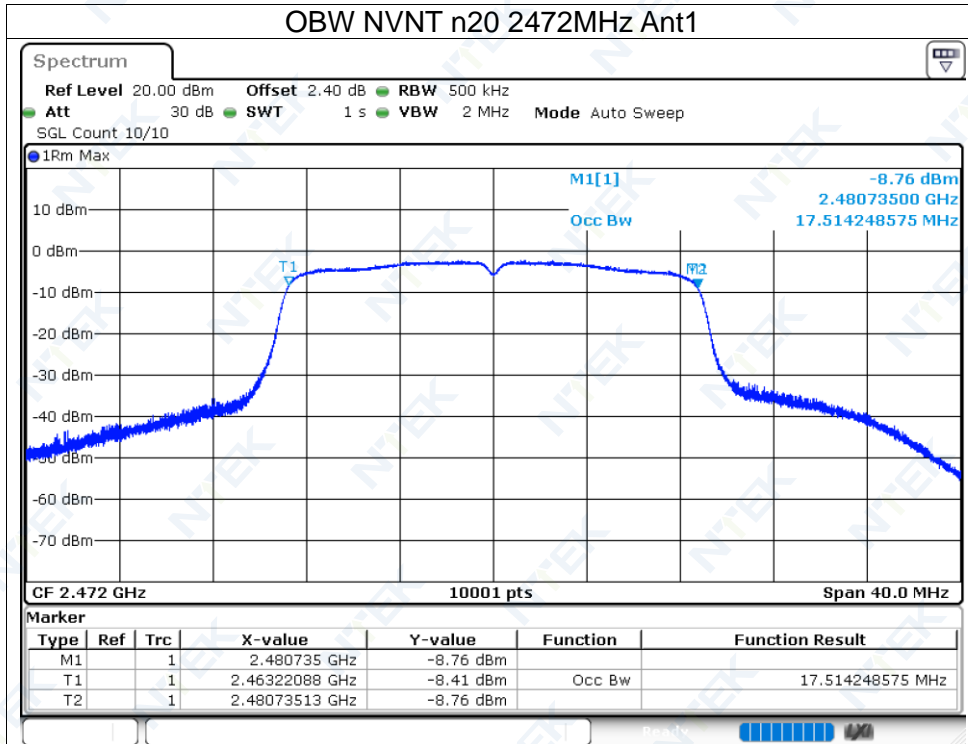

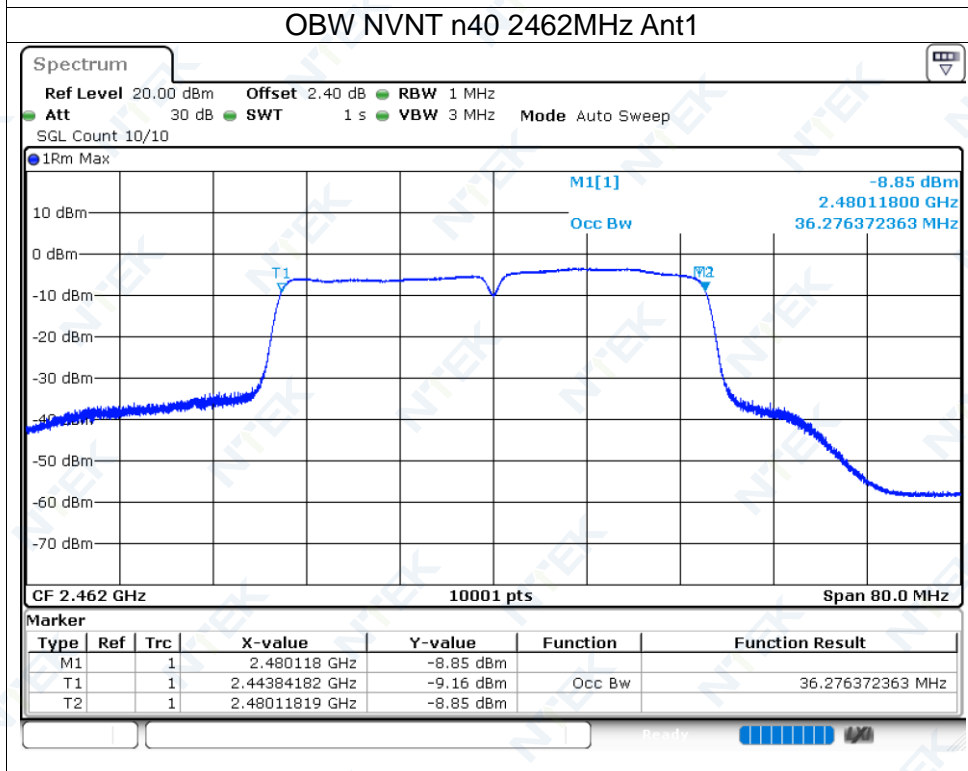
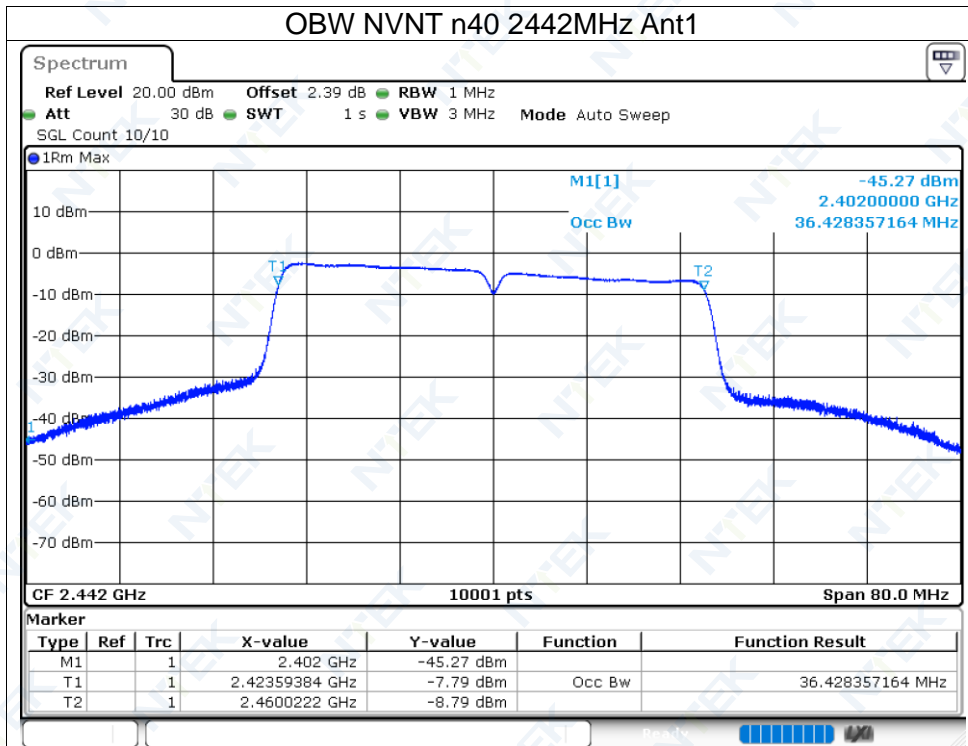

4.4 Transmitter unwanted emissions in the out-of-band domain

Condition	Mode	Frequency (MHz)	Antenna	OOB Frequency (MHz)	Level (dBm/MHz)	Limit (dBm/MHz)	Verdict
NVNT	b	2412	Ant1	2399.5	-32.18	-10	Pass
NVNT	b	2412	Ant1	2398.5	-37.81	-10	Pass
NVNT	b	2412	Ant1	2397.5	-40.77	-10	Pass
NVNT	b	2412	Ant1	2396.5	-44.46	-10	Pass
NVNT	b	2412	Ant1	2395.5	-44.65	-10	Pass
NVNT	b	2412	Ant1	2394.5	-48.97	-10	Pass
NVNT	b	2412	Ant1	2393.5	-50.54	-10	Pass
NVNT	b	2412	Ant1	2392.5	-51.93	-10	Pass
NVNT	b	2412	Ant1	2391.5	-50.99	-10	Pass
NVNT	b	2412	Ant1	2390.5	-47.5	-10	Pass
NVNT	b	2412	Ant1	2389.5	-50.67	-10	Pass
NVNT	b	2412	Ant1	2388.5	-52.49	-10	Pass
NVNT	b	2412	Ant1	2388.429	-52.72	-10	Pass
NVNT	b	2412	Ant1	2387.429	-54.71	-20	Pass
NVNT	b	2412	Ant1	2386.429	-54.6	-20	Pass
NVNT	b	2412	Ant1	2385.429	-57.25	-20	Pass
NVNT	b	2412	Ant1	2384.429	-57.43	-20	Pass
NVNT	b	2412	Ant1	2383.429	-58.39	-20	Pass
NVNT	b	2412	Ant1	2382.429	-59.67	-20	Pass
NVNT	b	2412	Ant1	2381.429	-60	-20	Pass
NVNT	b	2412	Ant1	2380.429	-60.12	-20	Pass
NVNT	b	2412	Ant1	2379.429	-60.17	-20	Pass
NVNT	b	2412	Ant1	2378.429	-60.17	-20	Pass
NVNT	b	2412	Ant1	2377.429	-60.22	-20	Pass
NVNT	b	2412	Ant1	2376.429	-60.22	-20	Pass
NVNT	b	2412	Ant1	2376.358	-60.22	-20	Pass
NVNT	b	2472	Ant1	2484	-31.52	-10	Pass
NVNT	b	2472	Ant1	2485	-29.5	-10	Pass
NVNT	b	2472	Ant1	2486	-29.6	-10	Pass
NVNT	b	2472	Ant1	2487	-30.46	-10	Pass
NVNT	b	2472	Ant1	2488	-38.47	-10	Pass
NVNT	b	2472	Ant1	2489	-45.04	-10	Pass
NVNT	b	2472	Ant1	2490	-48.84	-10	Pass
NVNT	b	2472	Ant1	2491	-51.09	-10	Pass
NVNT	b	2472	Ant1	2492	-53.36	-10	Pass
NVNT	b	2472	Ant1	2493	-52.8	-10	Pass
NVNT	b	2472	Ant1	2494	-55.96	-10	Pass
NVNT	b	2472	Ant1	2494.435	-56.18	-10	Pass
NVNT	b	2472	Ant1	2495.435	-58.81	-20	Pass
NVNT	b	2472	Ant1	2496.435	-59.45	-20	Pass
NVNT	b	2472	Ant1	2497.435	-59.71	-20	Pass
NVNT	b	2472	Ant1	2498.435	-59.8	-20	Pass
NVNT	b	2472	Ant1	2499.435	-59.84	-20	Pass
NVNT	b	2472	Ant1	2500.435	-59.87	-20	Pass
NVNT	b	2472	Ant1	2501.435	-59.86	-20	Pass
NVNT	b	2472	Ant1	2502.435	-59.9	-20	Pass
NVNT	b	2472	Ant1	2503.435	-59.9	-20	Pass
NVNT	b	2472	Ant1	2504.435	-59.92	-20	Pass
NVNT	b	2472	Ant1	2505.435	-59.91	-20	Pass
NVNT	b	2472	Ant1	2505.87	-59.92	-20	Pass

NVNT	g	2412	Ant1	2399.5	-16.53	-10	Pass
NVNT	g	2412	Ant1	2398.5	-16.49	-10	Pass
NVNT	g	2412	Ant1	2397.5	-17.26	-10	Pass
NVNT	g	2412	Ant1	2396.5	-18.78	-10	Pass
NVNT	g	2412	Ant1	2395.5	-20.09	-10	Pass
NVNT	g	2412	Ant1	2394.5	-21.87	-10	Pass
NVNT	g	2412	Ant1	2393.5	-22.61	-10	Pass
NVNT	g	2412	Ant1	2392.5	-23.64	-10	Pass
NVNT	g	2412	Ant1	2391.5	-24.25	-10	Pass
NVNT	g	2412	Ant1	2390.5	-25.97	-10	Pass
NVNT	g	2412	Ant1	2389.5	-26.62	-10	Pass
NVNT	g	2412	Ant1	2388.5	-27.96	-10	Pass
NVNT	g	2412	Ant1	2387.5	-30.44	-10	Pass
NVNT	g	2412	Ant1	2386.5	-33.03	-10	Pass
NVNT	g	2412	Ant1	2385.5	-35.92	-10	Pass
NVNT	g	2412	Ant1	2384.5	-38.45	-10	Pass
NVNT	g	2412	Ant1	2383.886	-40.23	-10	Pass
NVNT	g	2412	Ant1	2382.886	-44.29	-20	Pass
NVNT	g	2412	Ant1	2381.886	-48.37	-20	Pass
NVNT	g	2412	Ant1	2380.886	-52.9	-20	Pass
NVNT	g	2412	Ant1	2379.886	-56.31	-20	Pass
NVNT	g	2412	Ant1	2378.886	-57.49	-20	Pass
NVNT	g	2412	Ant1	2377.886	-58.01	-20	Pass
NVNT	g	2412	Ant1	2376.886	-58.3	-20	Pass
NVNT	g	2412	Ant1	2375.886	-58.48	-20	Pass
NVNT	g	2412	Ant1	2374.886	-58.55	-20	Pass
NVNT	g	2412	Ant1	2373.886	-58.56	-20	Pass
NVNT	g	2412	Ant1	2372.886	-58.6	-20	Pass
NVNT	g	2412	Ant1	2371.886	-58.62	-20	Pass
NVNT	g	2412	Ant1	2370.886	-58.66	-20	Pass
NVNT	g	2412	Ant1	2369.886	-58.64	-20	Pass
NVNT	g	2412	Ant1	2368.886	-58.45	-20	Pass
NVNT	g	2412	Ant1	2367.886	-58.33	-20	Pass
NVNT	g	2412	Ant1	2367.272	-58.35	-20	Pass
NVNT	g	2472	Ant1	2484	-17.12	-10	Pass
NVNT	g	2472	Ant1	2485	-17.49	-10	Pass
NVNT	g	2472	Ant1	2486	-18.92	-10	Pass
NVNT	g	2472	Ant1	2487	-20.3	-10	Pass
NVNT	g	2472	Ant1	2488	-22.17	-10	Pass
NVNT	g	2472	Ant1	2489	-24.71	-10	Pass
NVNT	g	2472	Ant1	2490	-27.75	-10	Pass
NVNT	g	2472	Ant1	2491	-31.48	-10	Pass
NVNT	g	2472	Ant1	2492	-35.04	-10	Pass
NVNT	g	2472	Ant1	2493	-39.15	-10	Pass
NVNT	g	2472	Ant1	2494	-43.24	-10	Pass
NVNT	g	2472	Ant1	2495	-47.83	-10	Pass
NVNT	g	2472	Ant1	2496	-52.67	-10	Pass
NVNT	g	2472	Ant1	2497	-56.54	-10	Pass
NVNT	g	2472	Ant1	2498	-57.92	-10	Pass
NVNT	g	2472	Ant1	2499	-58.22	-10	Pass
NVNT	g	2472	Ant1	2499.626	-58.24	-10	Pass
NVNT	g	2472	Ant1	2500.626	-58.27	-20	Pass
NVNT	g	2472	Ant1	2501.626	-58.26	-20	Pass
NVNT	g	2472	Ant1	2502.626	-58.28	-20	Pass
NVNT	g	2472	Ant1	2503.626	-58.29	-20	Pass

NVNT	g	2472	Ant1	2504.626	-58.31	-20	Pass
NVNT	g	2472	Ant1	2505.626	-58.33	-20	Pass
NVNT	g	2472	Ant1	2506.626	-58.34	-20	Pass
NVNT	g	2472	Ant1	2507.626	-58.33	-20	Pass
NVNT	g	2472	Ant1	2508.626	-58.49	-20	Pass
NVNT	g	2472	Ant1	2509.626	-58.39	-20	Pass
NVNT	g	2472	Ant1	2510.626	-56.74	-20	Pass
NVNT	g	2472	Ant1	2511.626	-58.49	-20	Pass
NVNT	g	2472	Ant1	2512.626	-58.49	-20	Pass
NVNT	g	2472	Ant1	2513.626	-58.35	-20	Pass
NVNT	g	2472	Ant1	2514.626	-58.34	-20	Pass
NVNT	g	2472	Ant1	2515.626	-58.37	-20	Pass
NVNT	g	2472	Ant1	2516.252	-58.18	-20	Pass
NVNT	n20	2412	Ant1	2399.5	-17.6	-10	Pass
NVNT	n20	2412	Ant1	2398.5	-17.59	-10	Pass
NVNT	n20	2412	Ant1	2397.5	-18.6	-10	Pass
NVNT	n20	2412	Ant1	2396.5	-19.41	-10	Pass
NVNT	n20	2412	Ant1	2395.5	-20.07	-10	Pass
NVNT	n20	2412	Ant1	2394.5	-20.95	-10	Pass
NVNT	n20	2412	Ant1	2393.5	-22	-10	Pass
NVNT	n20	2412	Ant1	2392.5	-22.81	-10	Pass
NVNT	n20	2412	Ant1	2391.5	-24.1	-10	Pass
NVNT	n20	2412	Ant1	2390.5	-25	-10	Pass
NVNT	n20	2412	Ant1	2389.5	-27.05	-10	Pass
NVNT	n20	2412	Ant1	2388.5	-28.52	-10	Pass
NVNT	n20	2412	Ant1	2387.5	-30.51	-10	Pass
NVNT	n20	2412	Ant1	2386.5	-33.2	-10	Pass
NVNT	n20	2412	Ant1	2385.5	-36.75	-10	Pass
NVNT	n20	2412	Ant1	2384.5	-39.61	-10	Pass
NVNT	n20	2412	Ant1	2383.5	-43.3	-10	Pass
NVNT	n20	2412	Ant1	2382.826	-45.89	-10	Pass
NVNT	n20	2412	Ant1	2381.826	-50.46	-20	Pass
NVNT	n20	2412	Ant1	2380.826	-55.38	-20	Pass
NVNT	n20	2412	Ant1	2379.826	-57.68	-20	Pass
NVNT	n20	2412	Ant1	2378.826	-58.2	-20	Pass
NVNT	n20	2412	Ant1	2377.826	-58.38	-20	Pass
NVNT	n20	2412	Ant1	2376.826	-58.49	-20	Pass
NVNT	n20	2412	Ant1	2375.826	-58.55	-20	Pass
NVNT	n20	2412	Ant1	2374.826	-58.54	-20	Pass
NVNT	n20	2412	Ant1	2373.826	-58.56	-20	Pass
NVNT	n20	2412	Ant1	2372.826	-58.56	-20	Pass
NVNT	n20	2412	Ant1	2371.826	-58.57	-20	Pass
NVNT	n20	2412	Ant1	2370.826	-58.59	-20	Pass
NVNT	n20	2412	Ant1	2369.826	-58.56	-20	Pass
NVNT	n20	2412	Ant1	2368.826	-58.44	-20	Pass
NVNT	n20	2412	Ant1	2367.826	-58.37	-20	Pass
NVNT	n20	2412	Ant1	2366.826	-58.38	-20	Pass
NVNT	n20	2412	Ant1	2365.826	-58.37	-20	Pass
NVNT	n20	2412	Ant1	2365.152	-58.37	-20	Pass
NVNT	n20	2472	Ant1	2484	-18.78	-10	Pass
NVNT	n20	2472	Ant1	2485	-19.88	-10	Pass
NVNT	n20	2472	Ant1	2486	-20.89	-10	Pass
NVNT	n20	2472	Ant1	2487	-22.45	-10	Pass
NVNT	n20	2472	Ant1	2488	-24.54	-10	Pass
NVNT	n20	2472	Ant1	2489	-27.14	-10	Pass

NVNT	n20	2472	Ant1	2490	-30.31	-10	Pass
NVNT	n20	2472	Ant1	2491	-34.02	-10	Pass
NVNT	n20	2472	Ant1	2492	-38.22	-10	Pass
NVNT	n20	2472	Ant1	2493	-43.25	-10	Pass
NVNT	n20	2472	Ant1	2494	-47.97	-10	Pass
NVNT	n20	2472	Ant1	2495	-53.45	-10	Pass
NVNT	n20	2472	Ant1	2496	-57.24	-10	Pass
NVNT	n20	2472	Ant1	2497	-58.1	-10	Pass
NVNT	n20	2472	Ant1	2498	-58.21	-10	Pass
NVNT	n20	2472	Ant1	2499	-58.28	-10	Pass
NVNT	n20	2472	Ant1	2500	-58.23	-10	Pass
NVNT	n20	2472	Ant1	2500.514	-58.25	-10	Pass
NVNT	n20	2472	Ant1	2501.514	-58.24	-20	Pass
NVNT	n20	2472	Ant1	2502.514	-58.29	-20	Pass
NVNT	n20	2472	Ant1	2503.514	-58.29	-20	Pass
NVNT	n20	2472	Ant1	2504.514	-58.29	-20	Pass
NVNT	n20	2472	Ant1	2505.514	-58.28	-20	Pass
NVNT	n20	2472	Ant1	2506.514	-58.26	-20	Pass
NVNT	n20	2472	Ant1	2507.514	-58.28	-20	Pass
NVNT	n20	2472	Ant1	2508.514	-58.44	-20	Pass
NVNT	n20	2472	Ant1	2509.514	-58.39	-20	Pass
NVNT	n20	2472	Ant1	2510.514	-56.63	-20	Pass
NVNT	n20	2472	Ant1	2511.514	-58.44	-20	Pass
NVNT	n20	2472	Ant1	2512.514	-58.44	-20	Pass
NVNT	n20	2472	Ant1	2513.514	-58.29	-20	Pass
NVNT	n20	2472	Ant1	2514.514	-58.32	-20	Pass
NVNT	n20	2472	Ant1	2515.514	-58.35	-20	Pass
NVNT	n20	2472	Ant1	2516.514	-58.3	-20	Pass
NVNT	n20	2472	Ant1	2517.514	-58.26	-20	Pass
NVNT	n20	2472	Ant1	2518.028	-58.28	-20	Pass
NVNT	n40	2422	Ant1	2399.5	-25.34	-10	Pass
NVNT	n40	2422	Ant1	2398.5	-24.07	-10	Pass
NVNT	n40	2422	Ant1	2397.5	-26.78	-10	Pass
NVNT	n40	2422	Ant1	2396.5	-26.8	-10	Pass
NVNT	n40	2422	Ant1	2395.5	-28.49	-10	Pass
NVNT	n40	2422	Ant1	2394.5	-28.17	-10	Pass
NVNT	n40	2422	Ant1	2393.5	-28.98	-10	Pass
NVNT	n40	2422	Ant1	2392.5	-30.63	-10	Pass
NVNT	n40	2422	Ant1	2391.5	-29.78	-10	Pass
NVNT	n40	2422	Ant1	2390.5	-32.41	-10	Pass
NVNT	n40	2422	Ant1	2389.5	-33.27	-10	Pass
NVNT	n40	2422	Ant1	2388.5	-36.73	-10	Pass
NVNT	n40	2422	Ant1	2387.5	-36.45	-10	Pass
NVNT	n40	2422	Ant1	2386.5	-41.4	-10	Pass
NVNT	n40	2422	Ant1	2385.5	-43.84	-10	Pass
NVNT	n40	2422	Ant1	2384.5	-47.04	-10	Pass
NVNT	n40	2422	Ant1	2383.5	-51.21	-10	Pass
NVNT	n40	2422	Ant1	2382.5	-54.72	-10	Pass
NVNT	n40	2422	Ant1	2381.5	-57.47	-10	Pass
NVNT	n40	2422	Ant1	2380.5	-58.13	-10	Pass
NVNT	n40	2422	Ant1	2379.5	-58.21	-10	Pass
NVNT	n40	2422	Ant1	2378.5	-58.23	-10	Pass
NVNT	n40	2422	Ant1	2377.5	-58.24	-10	Pass
NVNT	n40	2422	Ant1	2376.5	-58.23	-10	Pass
NVNT	n40	2422	Ant1	2375.5	-58.22	-10	Pass

NVNT	n40	2422	Ant1	2374.5	-58.21	-10	Pass
NVNT	n40	2422	Ant1	2373.5	-58.22	-10	Pass
NVNT	n40	2422	Ant1	2372.5	-58.22	-10	Pass
NVNT	n40	2422	Ant1	2371.5	-58.25	-10	Pass
NVNT	n40	2422	Ant1	2370.5	-58.35	-10	Pass
NVNT	n40	2422	Ant1	2369.5	-58.25	-10	Pass
NVNT	n40	2422	Ant1	2368.5	-58.24	-10	Pass
NVNT	n40	2422	Ant1	2367.5	-58.22	-10	Pass
NVNT	n40	2422	Ant1	2366.5	-58.23	-10	Pass
NVNT	n40	2422	Ant1	2365.5	-58.25	-10	Pass
NVNT	n40	2422	Ant1	2364.576	-58.26	-10	Pass
NVNT	n40	2422	Ant1	2363.576	-58.23	-20	Pass
NVNT	n40	2422	Ant1	2362.576	-58.26	-20	Pass
NVNT	n40	2422	Ant1	2361.576	-58.24	-20	Pass
NVNT	n40	2422	Ant1	2360.576	-58.23	-20	Pass
NVNT	n40	2422	Ant1	2359.576	-58.29	-20	Pass
NVNT	n40	2422	Ant1	2358.576	-58.27	-20	Pass
NVNT	n40	2422	Ant1	2357.576	-58.3	-20	Pass
NVNT	n40	2422	Ant1	2356.576	-58.31	-20	Pass
NVNT	n40	2422	Ant1	2355.576	-58.27	-20	Pass
NVNT	n40	2422	Ant1	2354.576	-58.27	-20	Pass
NVNT	n40	2422	Ant1	2353.576	-58.28	-20	Pass
NVNT	n40	2422	Ant1	2352.576	-58.33	-20	Pass
NVNT	n40	2422	Ant1	2351.576	-58.3	-20	Pass
NVNT	n40	2422	Ant1	2350.576	-58.35	-20	Pass
NVNT	n40	2422	Ant1	2349.576	-58.32	-20	Pass
NVNT	n40	2422	Ant1	2348.576	-58.34	-20	Pass
NVNT	n40	2422	Ant1	2347.576	-58.3	-20	Pass
NVNT	n40	2422	Ant1	2346.576	-58.31	-20	Pass
NVNT	n40	2422	Ant1	2345.576	-58.34	-20	Pass
NVNT	n40	2422	Ant1	2344.576	-58.31	-20	Pass
NVNT	n40	2422	Ant1	2343.576	-58.35	-20	Pass
NVNT	n40	2422	Ant1	2342.576	-58.45	-20	Pass
NVNT	n40	2422	Ant1	2341.576	-58.34	-20	Pass
NVNT	n40	2422	Ant1	2340.576	-58.29	-20	Pass
NVNT	n40	2422	Ant1	2339.576	-58.33	-20	Pass
NVNT	n40	2422	Ant1	2338.576	-58.33	-20	Pass
NVNT	n40	2422	Ant1	2337.576	-58.31	-20	Pass
NVNT	n40	2422	Ant1	2336.576	-58.33	-20	Pass
NVNT	n40	2422	Ant1	2335.576	-58.31	-20	Pass
NVNT	n40	2422	Ant1	2334.576	-58.3	-20	Pass
NVNT	n40	2422	Ant1	2333.576	-58.31	-20	Pass
NVNT	n40	2422	Ant1	2332.576	-58.28	-20	Pass
NVNT	n40	2422	Ant1	2331.576	-58.31	-20	Pass
NVNT	n40	2422	Ant1	2330.576	-58.26	-20	Pass
NVNT	n40	2422	Ant1	2329.576	-58.29	-20	Pass
NVNT	n40	2422	Ant1	2328.652	-58.3	-20	Pass
NVNT	n40	2462	Ant1	2484	-23.57	-10	Pass
NVNT	n40	2462	Ant1	2485	-22.7	-10	Pass
NVNT	n40	2462	Ant1	2486	-24.54	-10	Pass
NVNT	n40	2462	Ant1	2487	-24.13	-10	Pass
NVNT	n40	2462	Ant1	2488	-26.45	-10	Pass
NVNT	n40	2462	Ant1	2489	-27.57	-10	Pass
NVNT	n40	2462	Ant1	2490	-31.08	-10	Pass
NVNT	n40	2462	Ant1	2491	-33.73	-10	Pass

NVNT	n40	2462	Ant1	2492	-35.77	-10	Pass
NVNT	n40	2462	Ant1	2493	-41.03	-10	Pass
NVNT	n40	2462	Ant1	2494	-44.25	-10	Pass
NVNT	n40	2462	Ant1	2495	-48.46	-10	Pass
NVNT	n40	2462	Ant1	2496	-52.18	-10	Pass
NVNT	n40	2462	Ant1	2497	-56.01	-10	Pass
NVNT	n40	2462	Ant1	2498	-57.68	-10	Pass
NVNT	n40	2462	Ant1	2499	-57.93	-10	Pass
NVNT	n40	2462	Ant1	2500	-57.89	-10	Pass
NVNT	n40	2462	Ant1	2501	-57.93	-10	Pass
NVNT	n40	2462	Ant1	2502	-57.95	-10	Pass
NVNT	n40	2462	Ant1	2503	-57.93	-10	Pass
NVNT	n40	2462	Ant1	2504	-57.96	-10	Pass
NVNT	n40	2462	Ant1	2505	-58.02	-10	Pass
NVNT	n40	2462	Ant1	2506	-58	-10	Pass
NVNT	n40	2462	Ant1	2507	-58	-10	Pass
NVNT	n40	2462	Ant1	2508	-56.37	-10	Pass
NVNT	n40	2462	Ant1	2509	-58.2	-10	Pass
NVNT	n40	2462	Ant1	2510	-56.42	-10	Pass
NVNT	n40	2462	Ant1	2511	-58.16	-10	Pass
NVNT	n40	2462	Ant1	2512	-58.16	-10	Pass
NVNT	n40	2462	Ant1	2513	-58.18	-10	Pass
NVNT	n40	2462	Ant1	2514	-58.06	-10	Pass
NVNT	n40	2462	Ant1	2515	-58.05	-10	Pass
NVNT	n40	2462	Ant1	2516	-58.03	-10	Pass
NVNT	n40	2462	Ant1	2517	-57.99	-10	Pass
NVNT	n40	2462	Ant1	2518	-57.94	-10	Pass
NVNT	n40	2462	Ant1	2519	-57.95	-10	Pass
NVNT	n40	2462	Ant1	2519.276	-57.99	-10	Pass
NVNT	n40	2462	Ant1	2520.276	-57.99	-20	Pass
NVNT	n40	2462	Ant1	2521.276	-57.98	-20	Pass
NVNT	n40	2462	Ant1	2522.276	-57.84	-20	Pass
NVNT	n40	2462	Ant1	2523.276	-57.98	-20	Pass
NVNT	n40	2462	Ant1	2524.276	-57.94	-20	Pass
NVNT	n40	2462	Ant1	2525.276	-57.87	-20	Pass
NVNT	n40	2462	Ant1	2526.276	-57.99	-20	Pass
NVNT	n40	2462	Ant1	2527.276	-57.96	-20	Pass
NVNT	n40	2462	Ant1	2528.276	-57.59	-20	Pass
NVNT	n40	2462	Ant1	2529.276	-57.72	-20	Pass
NVNT	n40	2462	Ant1	2530.276	-57.78	-20	Pass
NVNT	n40	2462	Ant1	2531.276	-57.96	-20	Pass
NVNT	n40	2462	Ant1	2532.276	-57.78	-20	Pass
NVNT	n40	2462	Ant1	2533.276	-55.38	-20	Pass
NVNT	n40	2462	Ant1	2534.276	-52.29	-20	Pass
NVNT	n40	2462	Ant1	2535.276	-57.73	-20	Pass
NVNT	n40	2462	Ant1	2536.276	-57.95	-20	Pass
NVNT	n40	2462	Ant1	2537.276	-57.97	-20	Pass
NVNT	n40	2462	Ant1	2538.276	-57.93	-20	Pass
NVNT	n40	2462	Ant1	2539.276	-57.94	-20	Pass
NVNT	n40	2462	Ant1	2540.276	-57.99	-20	Pass
NVNT	n40	2462	Ant1	2541.276	-57.96	-20	Pass
NVNT	n40	2462	Ant1	2542.276	-58.01	-20	Pass
NVNT	n40	2462	Ant1	2543.276	-57.98	-20	Pass
NVNT	n40	2462	Ant1	2544.276	-57.99	-20	Pass
NVNT	n40	2462	Ant1	2545.276	-57.99	-20	Pass

NVNT	n40	2462	Ant1	2546.276	-57.91	-20	Pass
NVNT	n40	2462	Ant1	2547.276	-57.95	-20	Pass
NVNT	n40	2462	Ant1	2548.276	-57.99	-20	Pass
NVNT	n40	2462	Ant1	2549.276	-58.02	-20	Pass
NVNT	n40	2462	Ant1	2550.276	-57.95	-20	Pass
NVNT	n40	2462	Ant1	2551.276	-57.98	-20	Pass
NVNT	n40	2462	Ant1	2552.276	-57.55	-20	Pass
NVNT	n40	2462	Ant1	2553.276	-58.01	-20	Pass
NVNT	n40	2462	Ant1	2554.276	-57.9	-20	Pass
NVNT	n40	2462	Ant1	2555.276	-57.95	-20	Pass
NVNT	n40	2462	Ant1	2555.552	-57.87	-20	Pass

Test Graphs

Tx. Emissions OOB NVNT b 2412MHz Ant1

Frequency: 2412 MHz

Transmitter unwanted emissions in the out-of-band domain

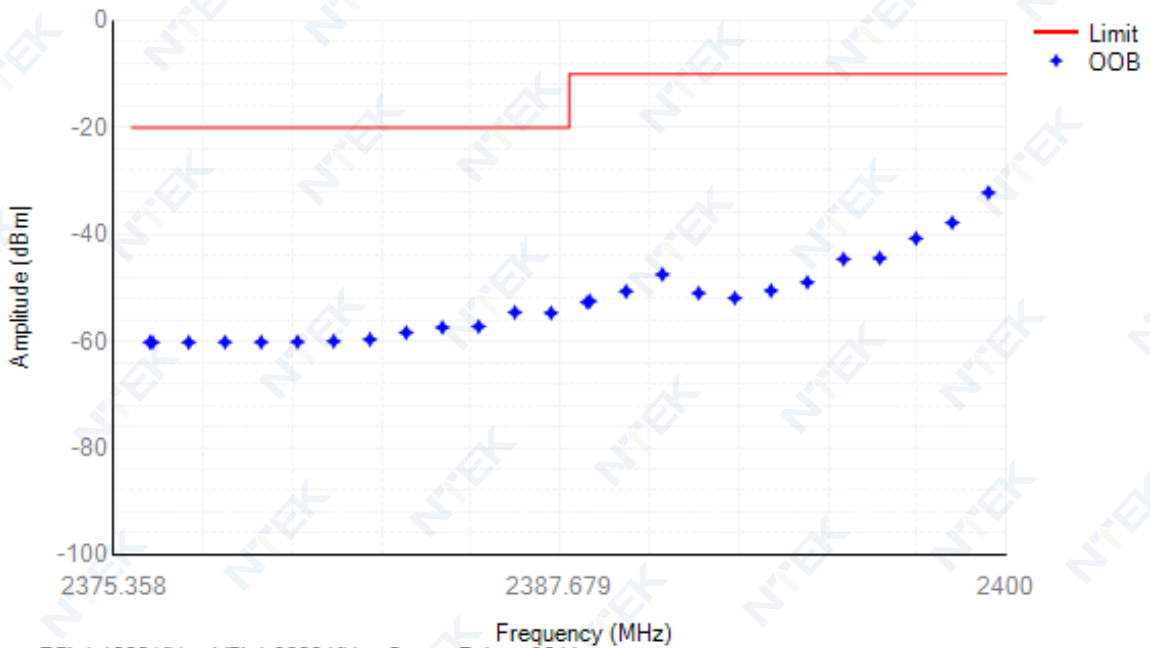

Tx. Emissions OOB NVNT b 2472MHz Ant1

Frequency: 2472 MHz

Transmitter unwanted emissions in the out-of-band domain

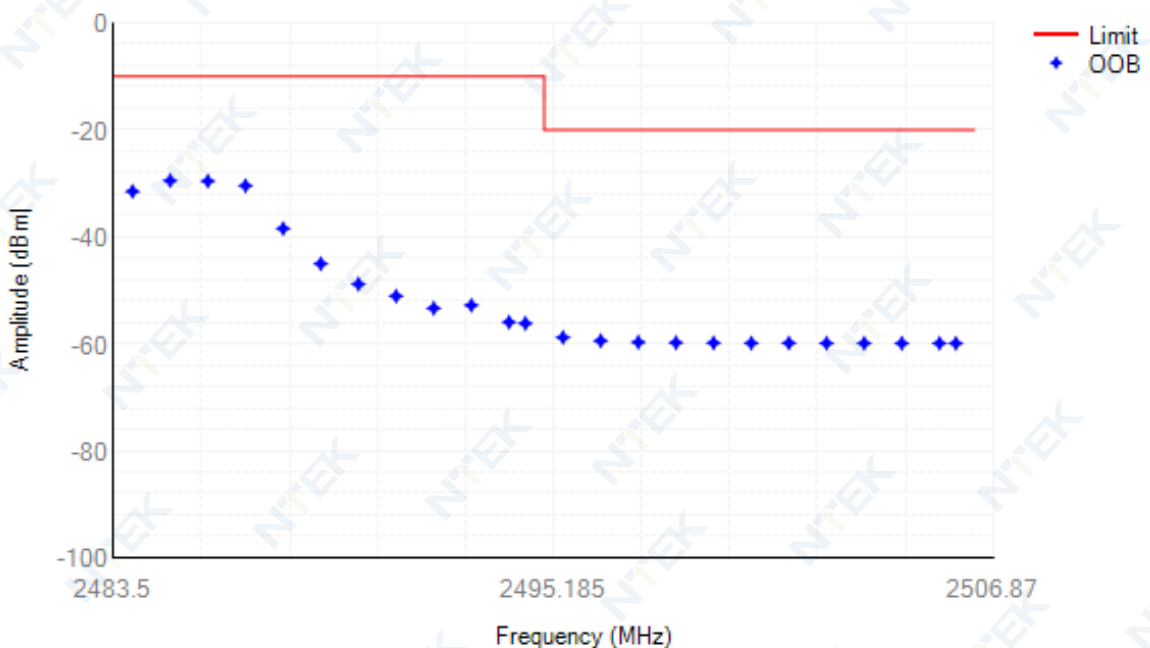

Tx. Emissions OOB NVNT g 2412MHz Ant1

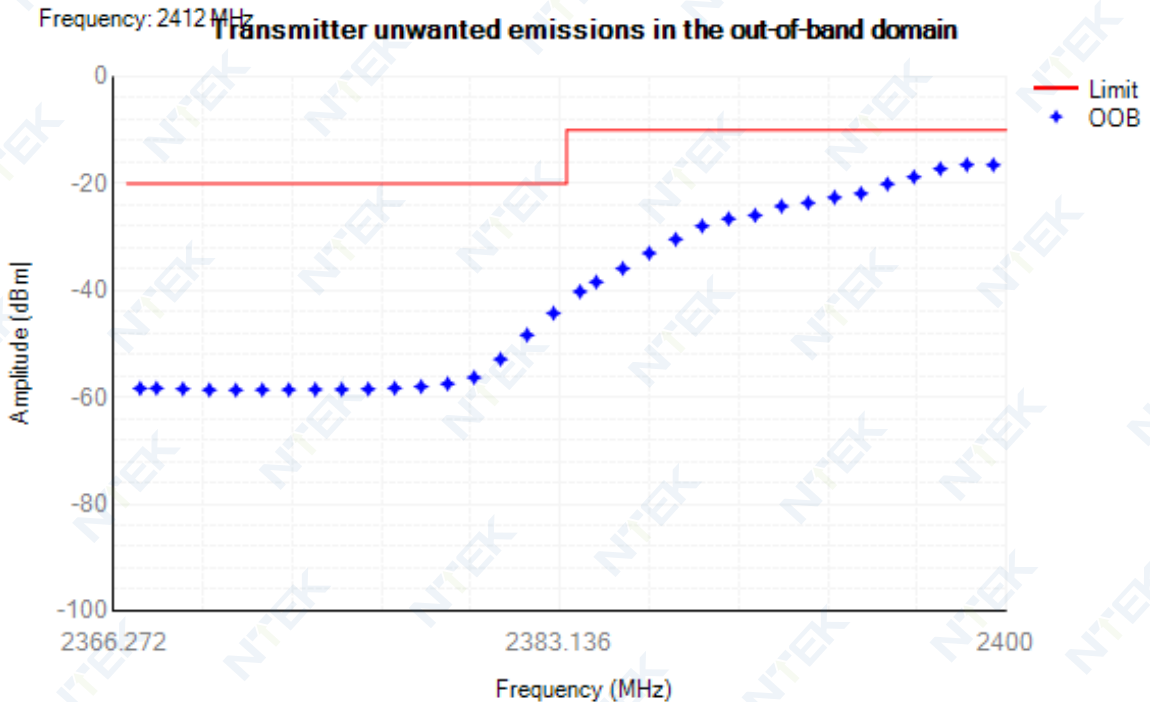

Tx. Emissions OOB NVNT g 2472MHz Ant1

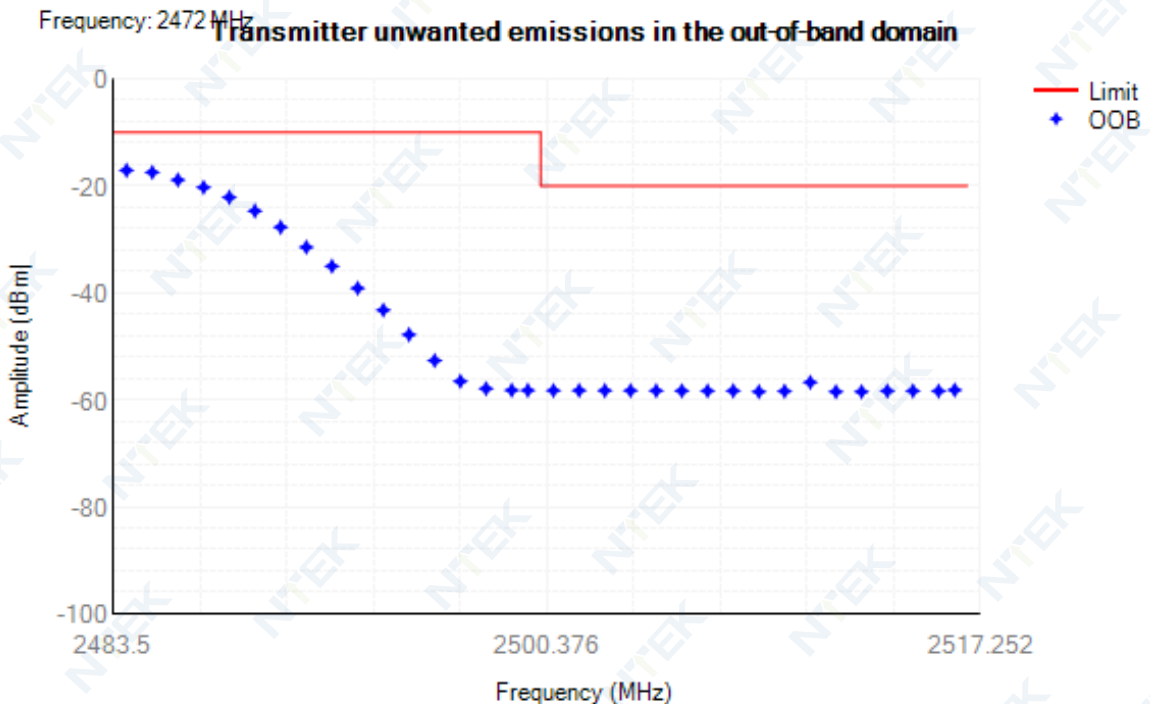

Tx. Emissions OOB NVNT n20 2412MHz Ant1

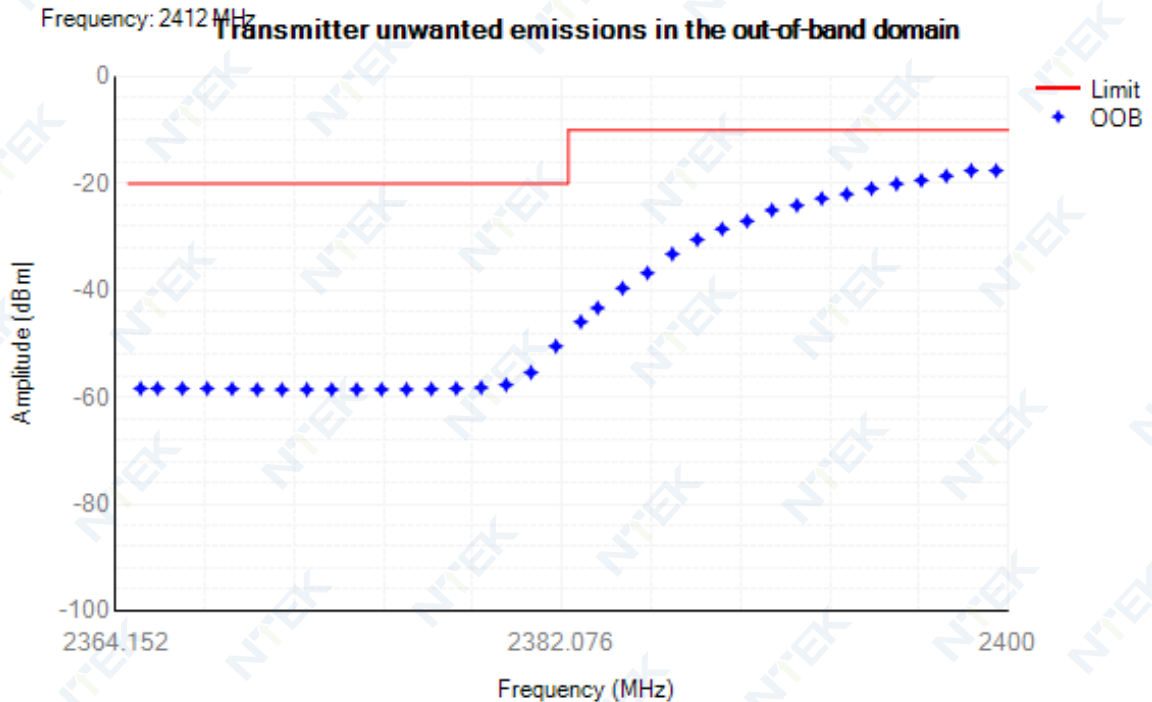

RBW: 1000 KHz, VBW: 3000 KHz, Sweep Points: 5001

Tx. Emissions OOB NVNT n20 2472MHz Ant1

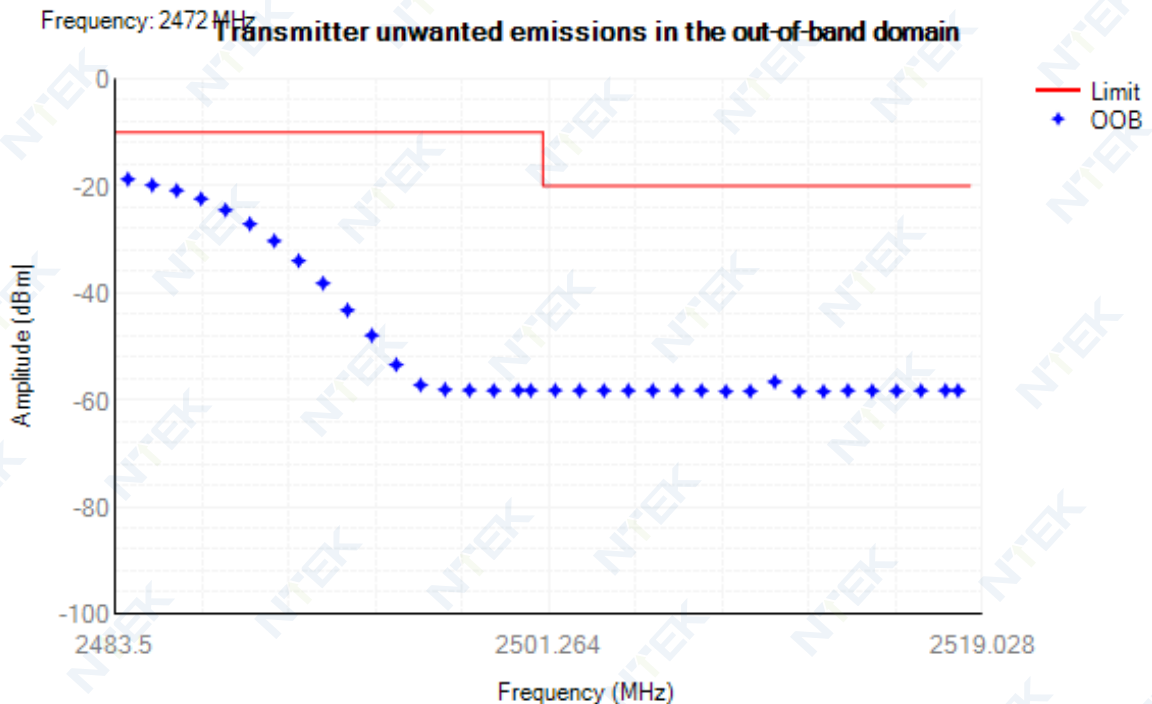

RBW: 1000 KHz, VBW: 3000 KHz, Sweep Points: 5001

Tx. Emissions OOB NVNT n40 2422MHz Ant1

Frequency: 2422 MHz

Transmitter unwanted emissions in the out-of-band domain

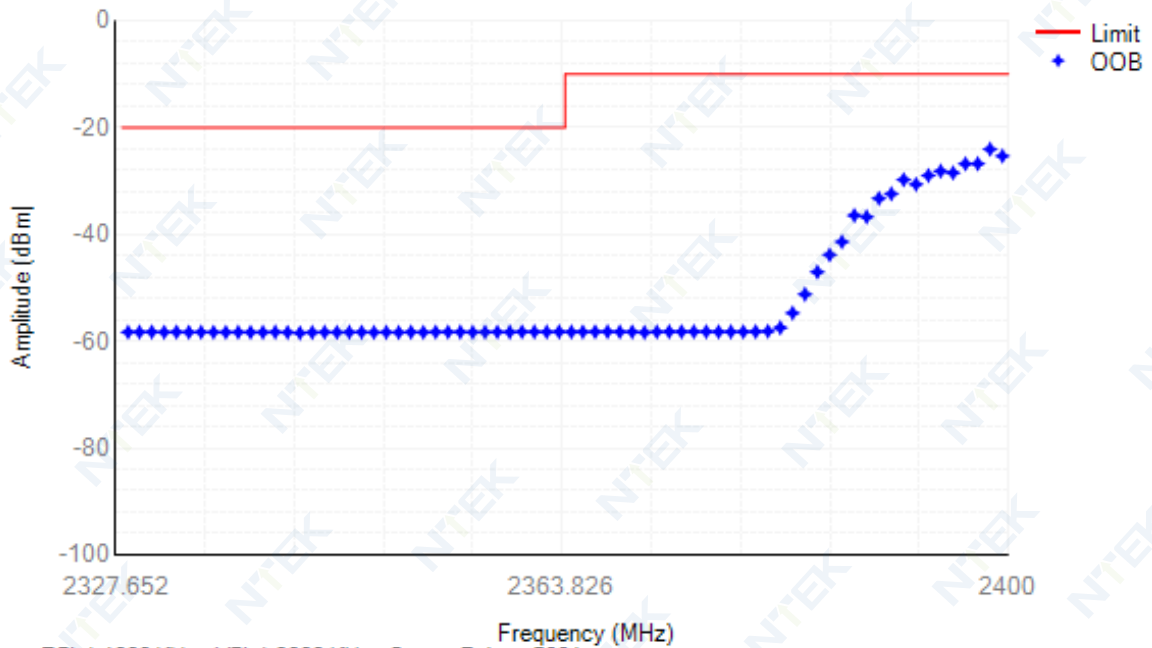

RBW: 1000 KHz, VBW: 3000 KHz, Sweep Points: 5001

Tx. Emissions OOB NVNT n40 2462MHz Ant1

Frequency: 2462 MHz

Transmitter unwanted emissions in the out-of-band domain

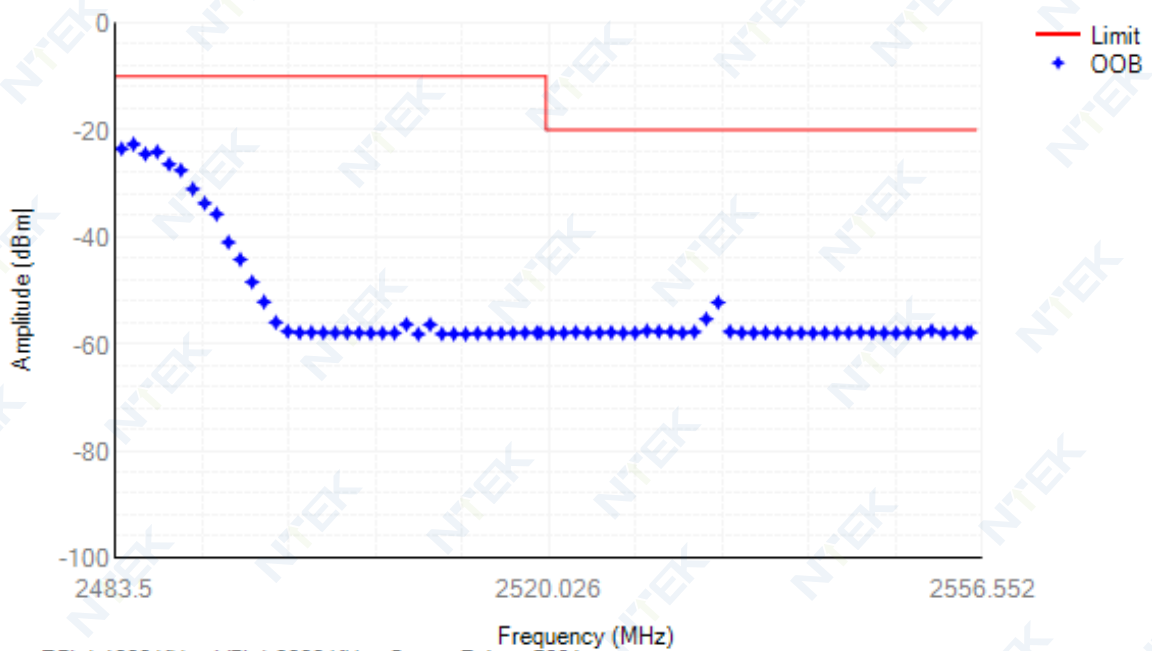

RBW: 1000 KHz, VBW: 3000 KHz, Sweep Points: 5001

4.5 Transmitter unwanted emissions in the spurious domain

Condition	Mode	Frequency (MHz)	Antenna	Range (MHz)	Spur Freq (MHz)	Peak (dBm)	RMS (dBm)	Limit (dBm)	Verdict
NVNT	b	2412	Ant1	30 -47	33.00	-81.47	NA	-36	Pass
NVNT	b	2412	Ant1	47 -74	63.35	-80.35	NA	-54	Pass
NVNT	b	2412	Ant1	74 -87.5	77.05	-79.71	NA	-36	Pass
NVNT	b	2412	Ant1	87.5 -118	106.35	-81.04	NA	-54	Pass
NVNT	b	2412	Ant1	118 -174	159.35	-80.46	NA	-36	Pass
NVNT	b	2412	Ant1	174 -230	221.50	-79.15	NA	-54	Pass
NVNT	b	2412	Ant1	230 -470	388.95	-78.12	NA	-36	Pass
NVNT	b	2412	Ant1	470 -694	619.05	-62.19	NA	-54	Pass
NVNT	b	2412	Ant1	694 -1000	974.55	-77.30	NA	-36	Pass
NVNT	b	2412	Ant1	1000 -2360	2216.00	-57.73	NA	-30	Pass
NVNT	b	2412	Ant1	2523.5 -12750	4824.00	-35.91	-36.57	-30	Pass
NVNT	b	2442	Ant1	30 -47	43.25	-81.69	NA	-36	Pass
NVNT	b	2442	Ant1	47 -74	53.75	-81.42	NA	-54	Pass
NVNT	b	2442	Ant1	74 -87.5	85.90	-81.05	NA	-36	Pass
NVNT	b	2442	Ant1	87.5 -118	91.60	-79.90	NA	-54	Pass
NVNT	b	2442	Ant1	118 -174	119.05	-80.32	NA	-36	Pass
NVNT	b	2442	Ant1	174 -230	225.10	-78.94	NA	-54	Pass
NVNT	b	2442	Ant1	230 -470	370.00	-79.20	NA	-36	Pass
NVNT	b	2442	Ant1	470 -694	679.05	-62.18	NA	-54	Pass
NVNT	b	2442	Ant1	694 -1000	858.50	-76.63	NA	-36	Pass
NVNT	b	2442	Ant1	1000 -2360	1714.00	-57.83	NA	-30	Pass
NVNT	b	2442	Ant1	2523.5 -12750	4884.00	-36.22	NA	-30	Pass
NVNT	b	2472	Ant1	30 -47	35.10	-81.38	NA	-36	Pass
NVNT	b	2472	Ant1	47 -74	64.30	-81.00	NA	-54	Pass
NVNT	b	2472	Ant1	74 -87.5	75.30	-81.05	NA	-36	Pass
NVNT	b	2472	Ant1	87.5 -118	107.90	-80.89	NA	-54	Pass
NVNT	b	2472	Ant1	118 -174	158.65	-79.65	NA	-36	Pass
NVNT	b	2472	Ant1	174 -230	207.10	-79.72	NA	-54	Pass
NVNT	b	2472	Ant1	230 -470	389.25	-79.14	NA	-36	Pass
NVNT	b	2472	Ant1	470 -694	535.05	-78.79	NA	-54	Pass
NVNT	b	2472	Ant1	694 -1000	739.05	-65.00	NA	-36	Pass
NVNT	b	2472	Ant1	1000 -2360	1736.50	-57.83	NA	-30	Pass
NVNT	b	2472	Ant1	2523.5 -12750	4944.00	-43.57	NA	-30	Pass
NVNT	g	2412	Ant1	30 -47	42.75	-81.71	NA	-36	Pass
NVNT	g	2412	Ant1	47 -74	56.35	-80.24	NA	-54	Pass
NVNT	g	2412	Ant1	74 -87.5	77.80	-81.64	NA	-36	Pass
NVNT	g	2412	Ant1	87.5 -118	89.90	-81.29	NA	-54	Pass
NVNT	g	2412	Ant1	118 -174	157.65	-80.06	NA	-36	Pass
NVNT	g	2412	Ant1	174 -230	221.40	-78.94	NA	-54	Pass
NVNT	g	2412	Ant1	230 -470	449.00	-79.33	NA	-36	Pass
NVNT	g	2412	Ant1	470 -694	613.45	-71.51	NA	-54	Pass
NVNT	g	2412	Ant1	694 -1000	968.10	-77.66	NA	-36	Pass
NVNT	g	2412	Ant1	1000 -2360	2124.00	-57.52	NA	-30	Pass
NVNT	g	2412	Ant1	2523.5 -12750	4819.00	-40.03	NA	-30	Pass
NVNT	g	2442	Ant1	30 -47	35.95	-80.99	NA	-36	Pass
NVNT	g	2442	Ant1	47 -74	70.50	-80.05	NA	-54	Pass
NVNT	g	2442	Ant1	74 -87.5	81.70	-81.20	NA	-36	Pass
NVNT	g	2442	Ant1	87.5 -118	89.40	-80.68	NA	-54	Pass
NVNT	g	2442	Ant1	118 -174	154.60	-79.98	NA	-36	Pass
NVNT	g	2442	Ant1	174 -230	221.80	-79.84	NA	-54	Pass
NVNT	g	2442	Ant1	230 -470	239.20	-78.23	NA	-36	Pass
NVNT	g	2442	Ant1	470 -694	684.80	-71.26	NA	-54	Pass
NVNT	g	2442	Ant1	694 -1000	977.00	-76.73	NA	-36	Pass
NVNT	g	2442	Ant1	1000 -2360	2328.50	-57.41	NA	-30	Pass
NVNT	g	2442	Ant1	2523.5 -12750	4893.50	-40.05	NA	-30	Pass
NVNT	g	2472	Ant1	30 -47	45.55	-81.92	NA	-36	Pass
NVNT	g	2472	Ant1	47 -74	59.65	-80.94	NA	-54	Pass
NVNT	g	2472	Ant1	74 -87.5	75.85	-81.07	NA	-36	Pass
NVNT	g	2472	Ant1	87.5 -118	112.65	-80.51	NA	-54	Pass
NVNT	g	2472	Ant1	118 -174	159.00	-80.12	NA	-36	Pass
NVNT	g	2472	Ant1	174 -230	197.60	-79.69	NA	-54	Pass
NVNT	g	2472	Ant1	230 -470	467.05	-77.86	NA	-36	Pass
NVNT	g	2472	Ant1	470 -694	485.20	-78.76	NA	-54	Pass
NVNT	g	2472	Ant1	694 -1000	737.35	-68.32	NA	-36	Pass
NVNT	g	2472	Ant1	1000 -2360	2198.50	-57.22	NA	-30	Pass
NVNT	g	2472	Ant1	2523.5 -12750	4932.00	-40.37	NA	-30	Pass
NVNT	n20	2412	Ant1	30 -47	34.50	-81.69	NA	-36	Pass
NVNT	n20	2412	Ant1	47 -74	52.75	-81.48	NA	-54	Pass
NVNT	n20	2412	Ant1	74 -87.5	81.90	-81.91	NA	-36	Pass
NVNT	n20	2412	Ant1	87.5 -118	96.70	-81.42	NA	-54	Pass
NVNT	n20	2412	Ant1	118 -174	122.70	-80.36	NA	-36	Pass
NVNT	n20	2412	Ant1	174 -230	175.85	-80.03	NA	-54	Pass
NVNT	n20	2412	Ant1	230 -470	347.05	-78.74	NA	-36	Pass
NVNT	n20	2412	Ant1	470 -694	614.90	-78.18	NA	-54	Pass
NVNT	n20	2412	Ant1	694 -1000	961.30	-77.64	NA	-36	Pass
NVNT	n20	2412	Ant1	1000 -2360	2172.00	-57.68	NA	-30	Pass
NVNT	n20	2412	Ant1	2523.5 -12750	4812.50	-41.84	NA	-30	Pass
NVNT	n20	2442	Ant1	30 -47	44.70	-81.33	NA	-36	Pass
NVNT	n20	2442	Ant1	47 -74	63.30	-81.38	NA	-54	Pass
NVNT	n20	2442	Ant1	74 -87.5	82.45	-80.60	NA	-36	Pass
NVNT	n20	2442	Ant1	87.5 -118	111.80	-80.59	NA	-54	Pass
NVNT	n20	2442	Ant1	118 -174	155.85	-80.04	NA	-36	Pass
NVNT	n20	2442	Ant1	174 -230	212.60	-79.30	NA	-54	Pass
NVNT	n20	2442	Ant1	230 -470	380.60	-78.56	NA	-36	Pass
NVNT	n20	2442	Ant1	470 -694	677.45	-78.77	NA	-54	Pass
NVNT	n20	2442	Ant1	694 -1000	939.45	-77.46	NA	-36	Pass
NVNT	n20	2442	Ant1	1000 -2360	2100.50	-57.78	NA	-30	Pass
NVNT	n20	2442	Ant1	2523.5 -12750	4894.50	-42.70	NA	-30	Pass
NVNT	n20	2472	Ant1	30 -47	39.35	-81.52	NA	-36	Pass
NVNT	n20	2472	Ant1	47 -74	64.00	-80.71	NA	-54	Pass

NVNT	n20	2472	Ant1	74 -87.5	77.50	-81.26	NA	-36	Pass
NVNT	n20	2472	Ant1	87.5 -118	101.45	-80.91	NA	-54	Pass
NVNT	n20	2472	Ant1	118 -174	161.40	-80.59	NA	-36	Pass
NVNT	n20	2472	Ant1	174 -230	202.55	-79.35	NA	-54	Pass
NVNT	n20	2472	Ant1	230 -470	270.45	-78.52	NA	-36	Pass
NVNT	n20	2472	Ant1	470 -694	522.25	-77.90	NA	-54	Pass
NVNT	n20	2472	Ant1	694 -1000	889.55	-77.55	NA	-36	Pass
NVNT	n20	2472	Ant1	1000 -2360	1814.00	-57.73	NA	-30	Pass
NVNT	n20	2472	Ant1	2523.5 -12750	4939.00	-47.90	NA	-30	Pass
NVNT	n40	2422	Ant1	30 -47	31.00	-77.74	NA	-36	Pass
NVNT	n40	2422	Ant1	47 -74	50.40	-81.04	NA	-54	Pass
NVNT	n40	2422	Ant1	74 -87.5	75.30	-81.45	NA	-36	Pass
NVNT	n40	2422	Ant1	87.5 -118	102.15	-80.79	NA	-54	Pass
NVNT	n40	2422	Ant1	118 -174	171.35	-80.18	NA	-36	Pass
NVNT	n40	2422	Ant1	174 -230	210.05	-79.76	NA	-54	Pass
NVNT	n40	2422	Ant1	230 -470	370.25	-79.35	NA	-36	Pass
NVNT	n40	2422	Ant1	470 -694	673.55	-78.73	NA	-54	Pass
NVNT	n40	2422	Ant1	694 -1000	912.55	-77.85	NA	-36	Pass
NVNT	n40	2422	Ant1	1000 -2320	2200.50	-57.75	NA	-30	Pass
NVNT	n40	2422	Ant1	2563.5 -12750	6883.00	-50.06	NA	-30	Pass
NVNT	n40	2442	Ant1	30 -47	30.25	-74.34	NA	-36	Pass
NVNT	n40	2442	Ant1	47 -74	73.65	-81.51	NA	-54	Pass
NVNT	n40	2442	Ant1	74 -87.5	81.90	-80.82	NA	-36	Pass
NVNT	n40	2442	Ant1	87.5 -118	99.15	-80.96	NA	-54	Pass
NVNT	n40	2442	Ant1	118 -174	164.50	-80.26	NA	-36	Pass
NVNT	n40	2442	Ant1	174 -230	224.10	-79.23	NA	-54	Pass
NVNT	n40	2442	Ant1	230 -470	326.70	-79.12	NA	-36	Pass
NVNT	n40	2442	Ant1	470 -694	642.30	-78.78	NA	-54	Pass
NVNT	n40	2442	Ant1	694 -1000	973.90	-78.16	NA	-36	Pass
NVNT	n40	2442	Ant1	1000 -2320	2263.00	-57.60	NA	-30	Pass
NVNT	n40	2442	Ant1	2563.5 -12750	4885.50	-48.45	NA	-30	Pass
NVNT	n40	2462	Ant1	30 -47	32.20	-76.78	NA	-36	Pass
NVNT	n40	2462	Ant1	47 -74	55.40	-80.60	NA	-54	Pass
NVNT	n40	2462	Ant1	74 -87.5	82.45	-81.50	NA	-36	Pass
NVNT	n40	2462	Ant1	87.5 -118	105.20	-81.26	NA	-54	Pass
NVNT	n40	2462	Ant1	118 -174	171.50	-79.91	NA	-36	Pass
NVNT	n40	2462	Ant1	174 -230	225.95	-79.74	NA	-54	Pass
NVNT	n40	2462	Ant1	230 -470	370.80	-78.50	NA	-36	Pass
NVNT	n40	2462	Ant1	470 -694	620.15	-79.29	NA	-54	Pass
NVNT	n40	2462	Ant1	694 -1000	947.55	-77.73	NA	-36	Pass
NVNT	n40	2462	Ant1	1000 -2320	2234.00	-57.39	NA	-30	Pass
NVNT	n40	2462	Ant1	2563.5 -12750	4917.00	-48.80	NA	-30	Pass

Test Graphs

Tx. Spurious NVNT b 2412MHz Ant1

Frequency: 2412 MHz

Transmitter unwanted emissions in the spurious domain

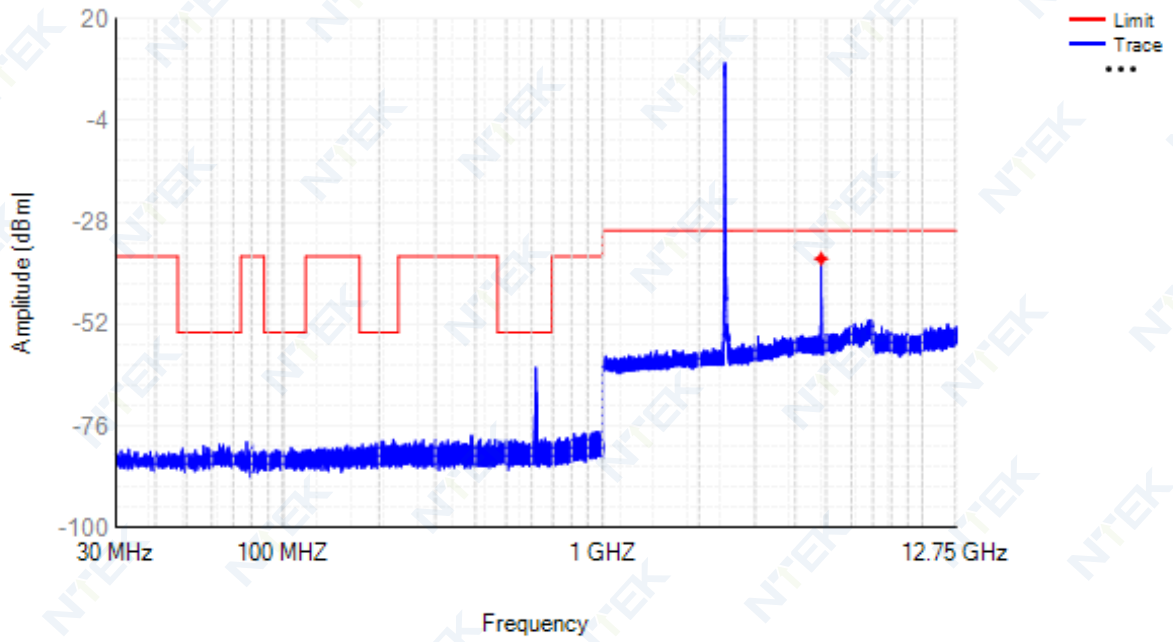

Tx. Spurious NVNT b 2442MHz Ant1

Frequency: 2442 MHz

Transmitter unwanted emissions in the spurious domain

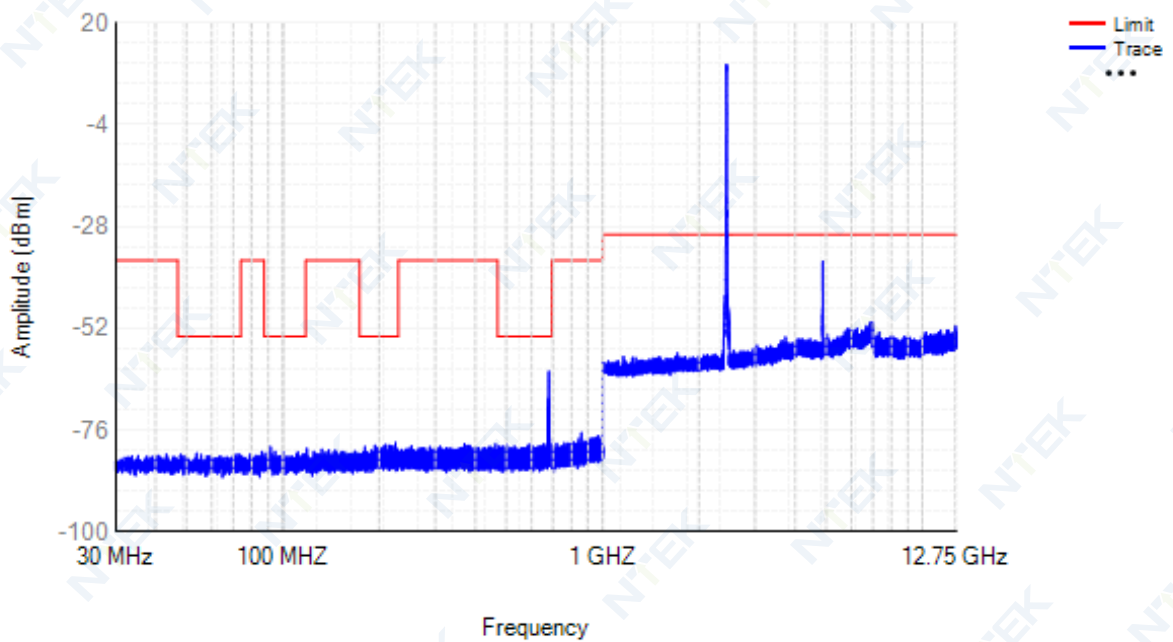

Tx. Spurious NVNT b 2472MHz Ant1

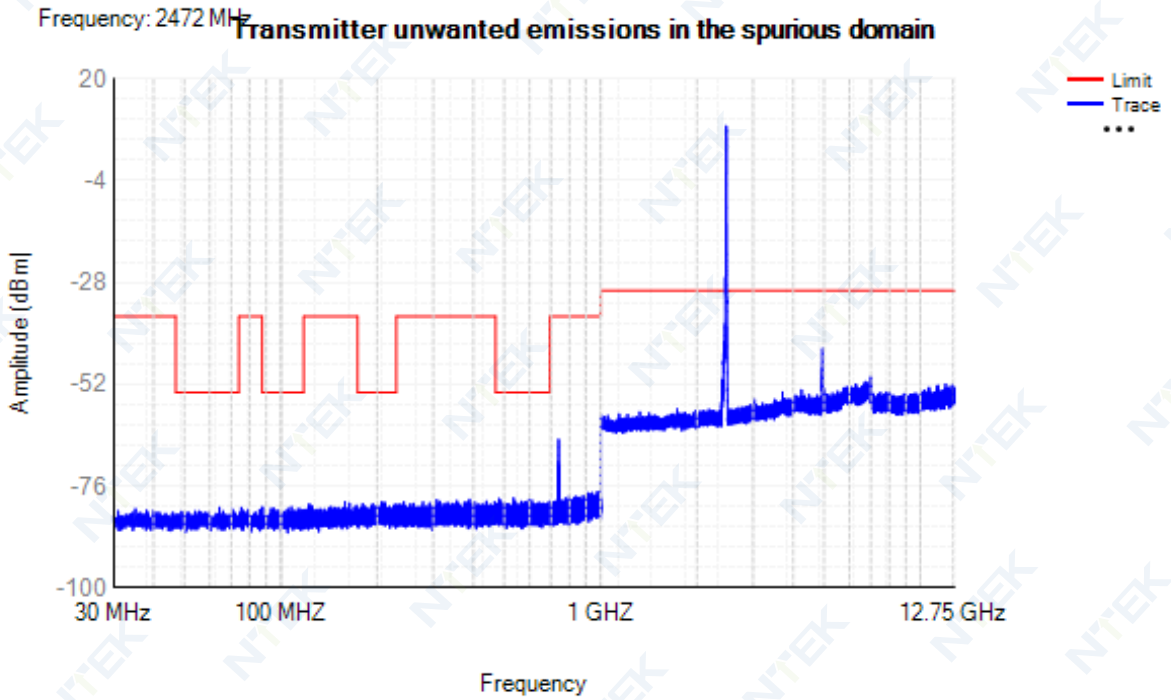

Tx. Spurious NVNT g 2412MHz Ant1

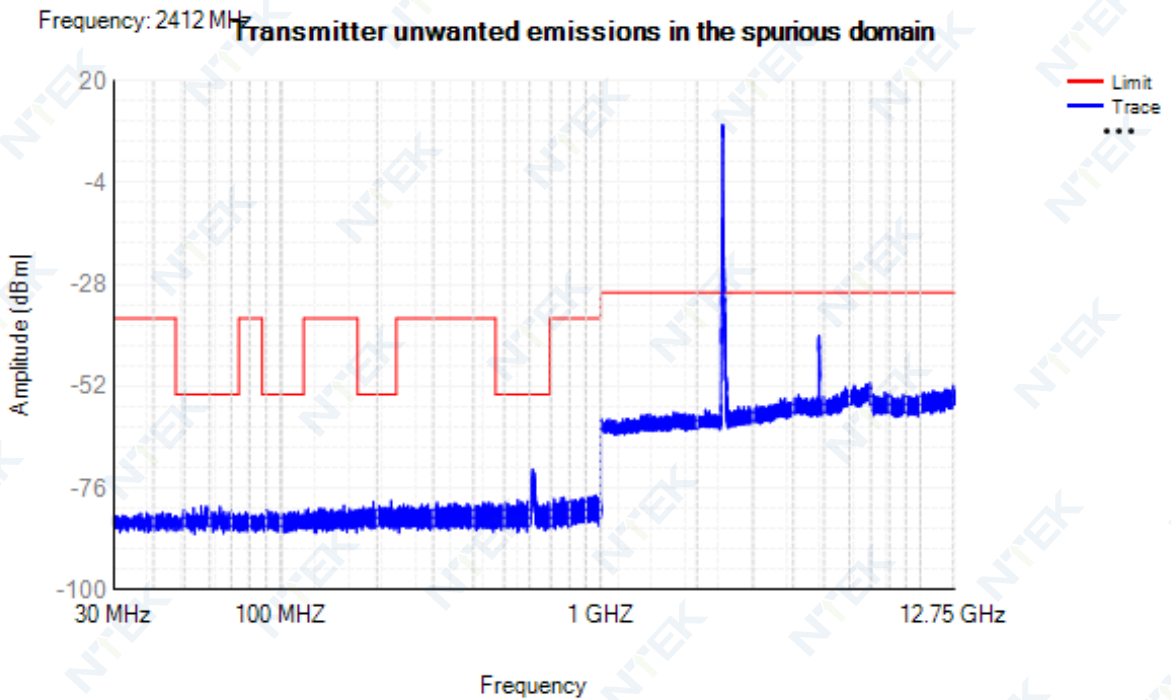

Tx. Spurious NVNT g 2442MHz Ant1

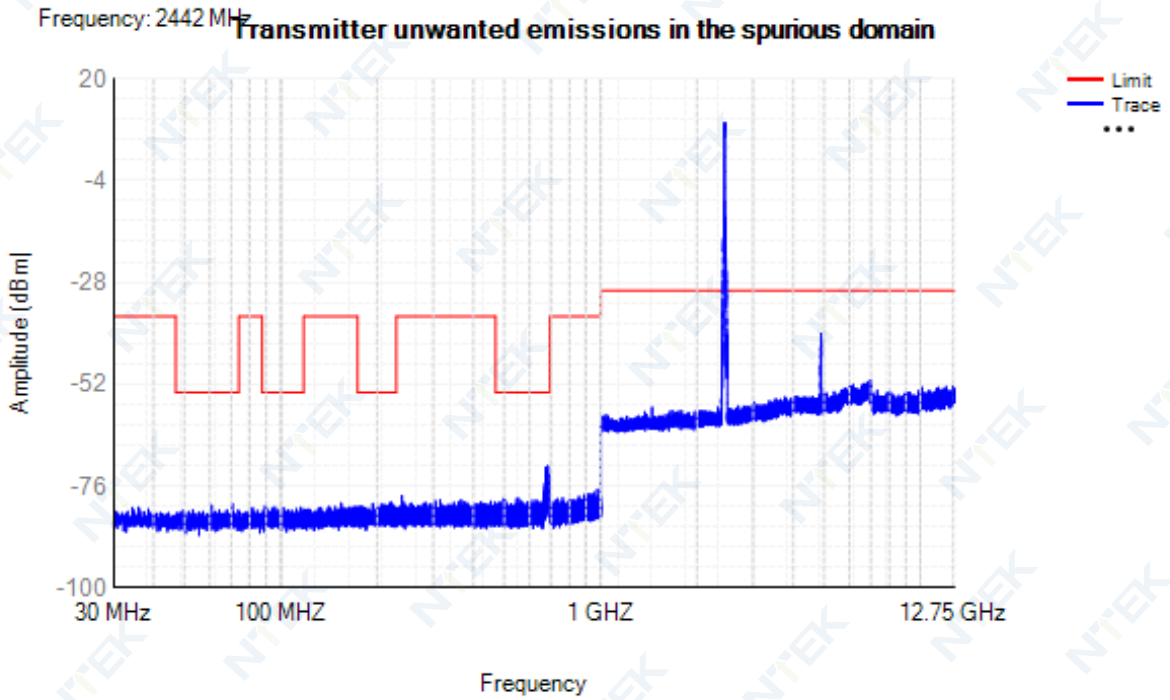

Tx. Spurious NVNT g 2472MHz Ant1

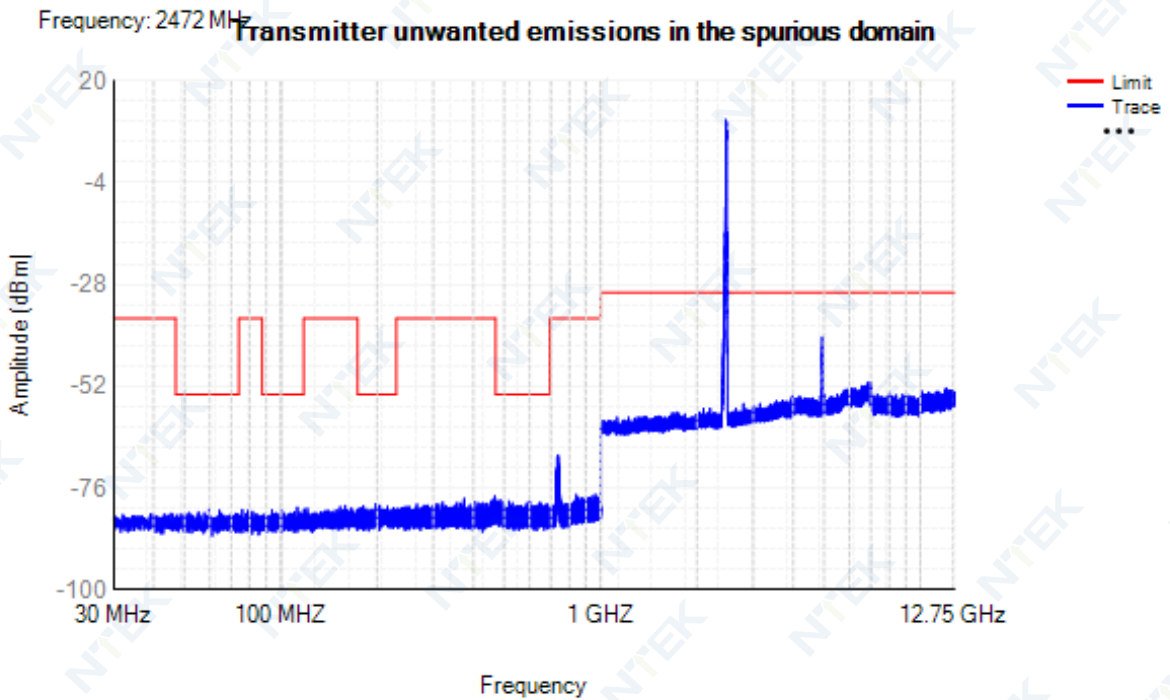

Tx. Spurious NVNT n20 2412MHz Ant1

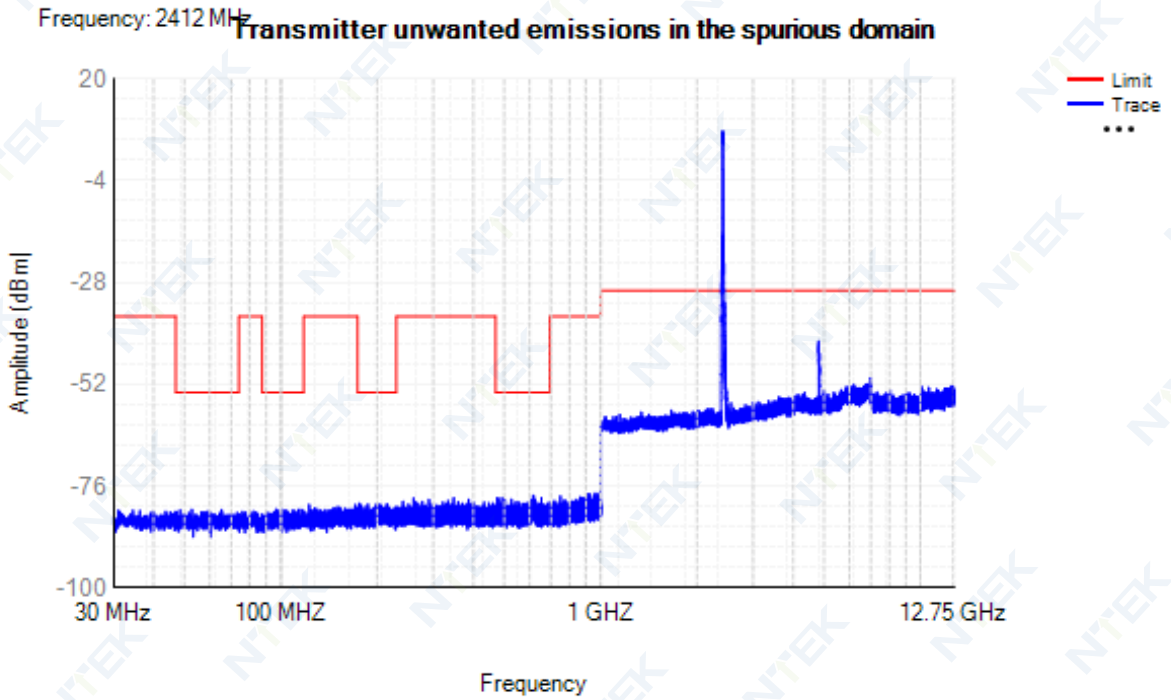

Tx. Spurious NVNT n20 2442MHz Ant1

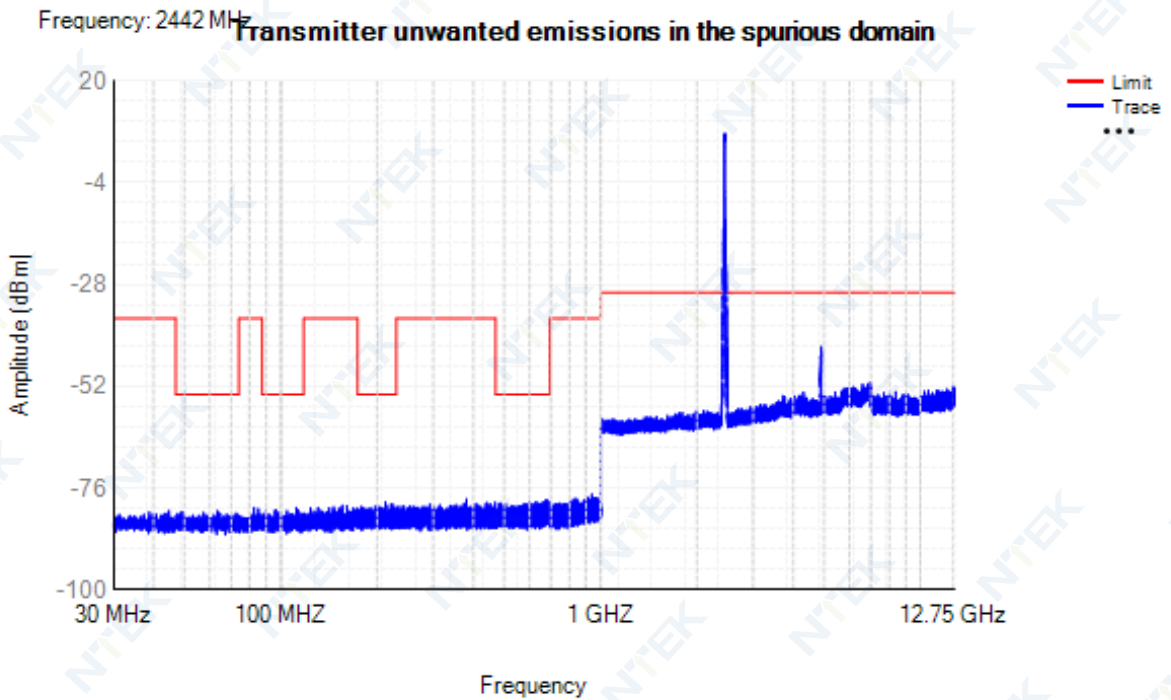

Tx. Spurious NVNT n20 2472MHz Ant1

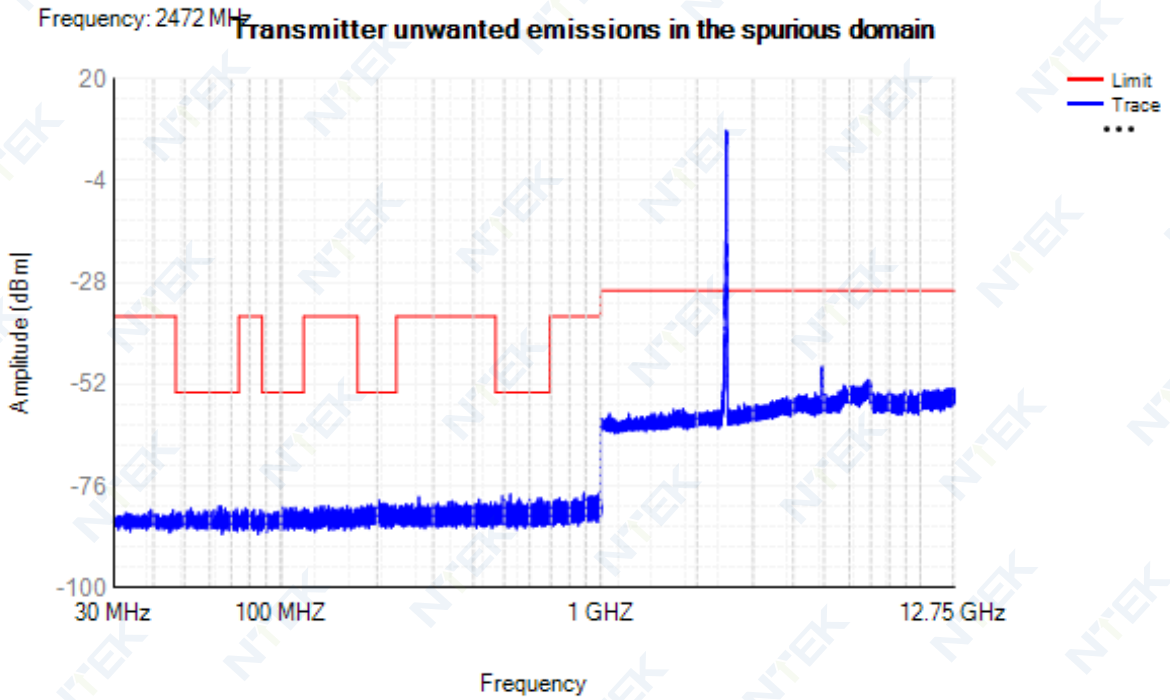

Tx. Spurious NVNT n40 2422MHz Ant1

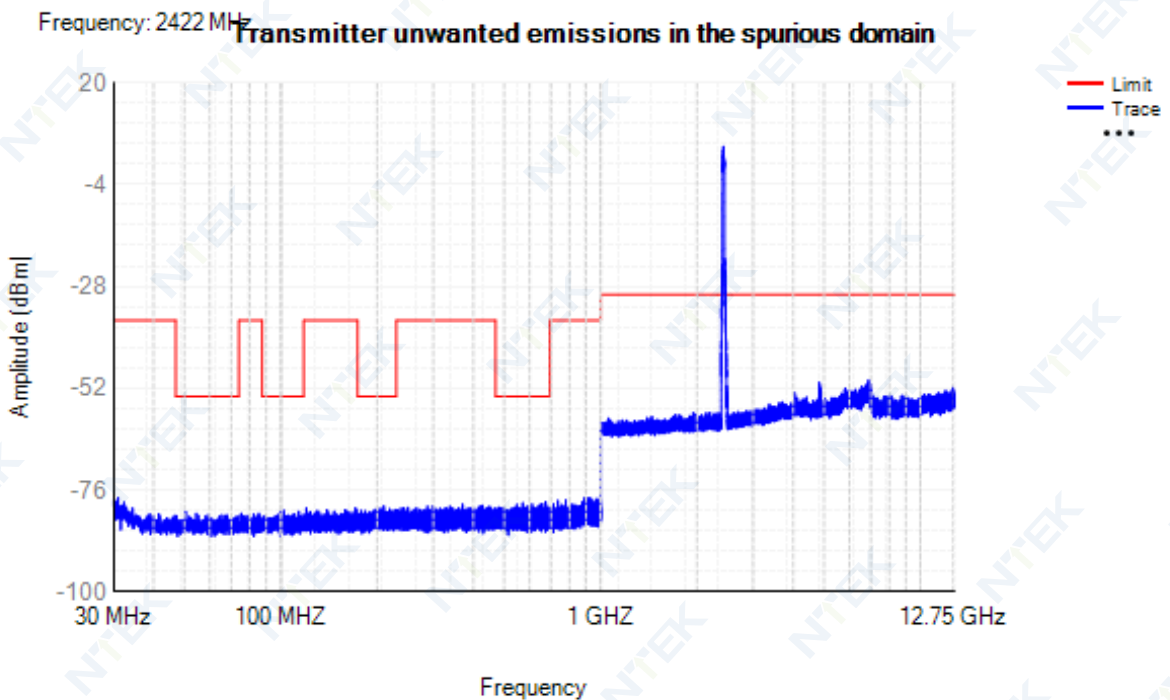

Tx. Spurious NVNT n40 2442MHz Ant1

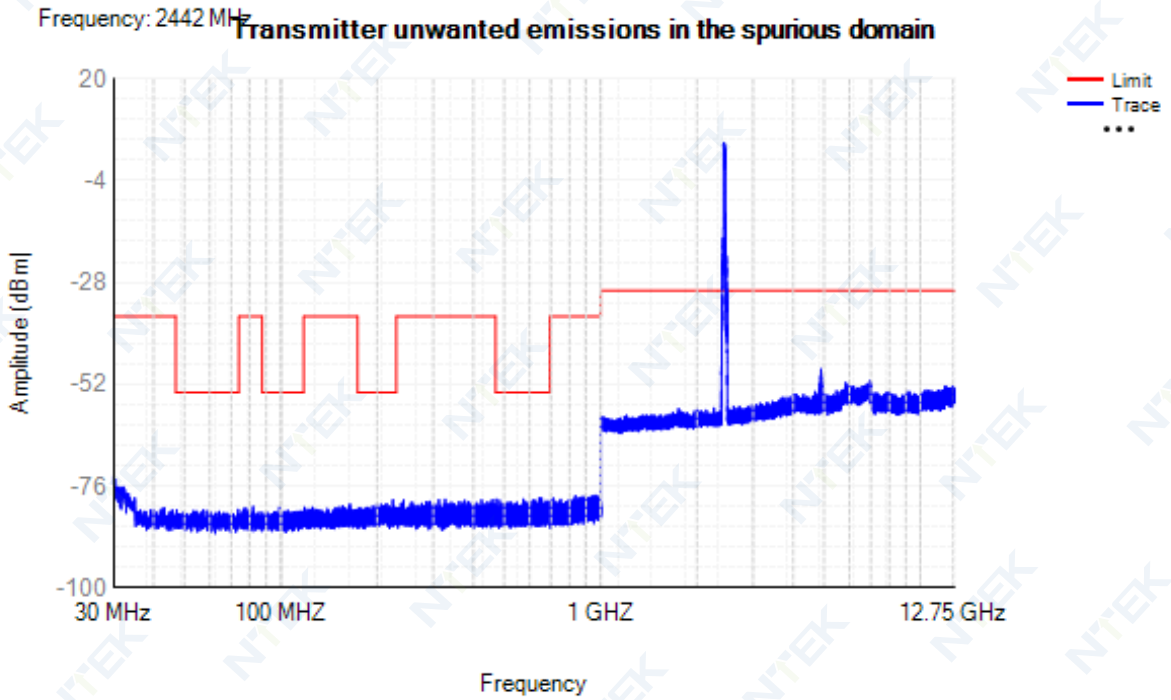

Tx. Spurious NVNT n40 2462MHz Ant1

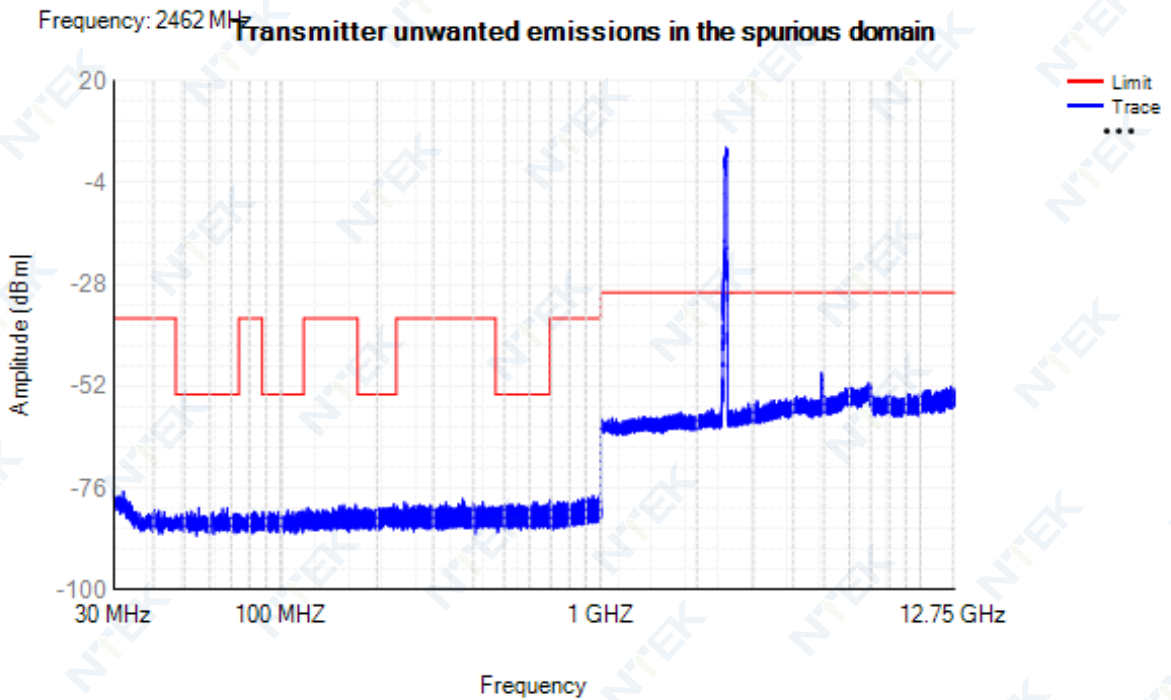

4.6 Receiver spurious emissions

Condition	Mode	Frequency (MHz)	Antenna	Range (MHz)	Spur Freq (MHz)	Peak (dBm)	RMS (dBm)	Limit (dBm)	Verdict
NVNT	b	2412	Ant1	30 -1000	884.15	-79.45	NA	-57	Pass
NVNT	b	2412	Ant1	1000 -12750	6844	-62.38	NA	-47	Pass
NVNT	b	2442	Ant1	30 -1000	946.9	-78.55	NA	-57	Pass
NVNT	b	2442	Ant1	1000 -12750	5817.5	-62.28	NA	-47	Pass
NVNT	b	2472	Ant1	30 -1000	995.4	-78.25	NA	-57	Pass
NVNT	b	2472	Ant1	1000 -12750	6989.5	-62.14	NA	-47	Pass
NVNT	g	2412	Ant1	30 -1000	431.35	-79.16	NA	-57	Pass
NVNT	g	2412	Ant1	1000 -12750	6962	-61.92	NA	-47	Pass
NVNT	g	2442	Ant1	30 -1000	975.75	-78.84	NA	-57	Pass
NVNT	g	2442	Ant1	1000 -12750	6905	-61.15	NA	-47	Pass
NVNT	g	2472	Ant1	30 -1000	954.75	-78.74	NA	-57	Pass
NVNT	g	2472	Ant1	1000 -12750	6804.5	-62.14	NA	-47	Pass
NVNT	n20	2412	Ant1	30 -1000	953.8	-77.77	NA	-57	Pass
NVNT	n20	2412	Ant1	1000 -12750	6816	-62.00	NA	-47	Pass
NVNT	n20	2442	Ant1	30 -1000	859.05	-78.10	NA	-57	Pass
NVNT	n20	2442	Ant1	1000 -12750	6971	-62.17	NA	-47	Pass
NVNT	n20	2472	Ant1	30 -1000	969.2	-78.21	NA	-57	Pass
NVNT	n20	2472	Ant1	1000 -12750	6921	-62.40	NA	-47	Pass
NVNT	n40	2422	Ant1	30 -1000	891.55	-79.17	NA	-57	Pass
NVNT	n40	2422	Ant1	1000 -12750	6847.5	-61.57	NA	-47	Pass
NVNT	n40	2442	Ant1	30 -1000	999.2	-78.56	NA	-57	Pass
NVNT	n40	2442	Ant1	1000 -12750	6995.5	-61.26	NA	-47	Pass
NVNT	n40	2462	Ant1	30 -1000	952.6	-78.55	NA	-57	Pass
NVNT	n40	2462	Ant1	1000 -12750	6932	-61.75	NA	-47	Pass

Test Graphs

Rx. Spurious NVNT b 2412MHz Ant1

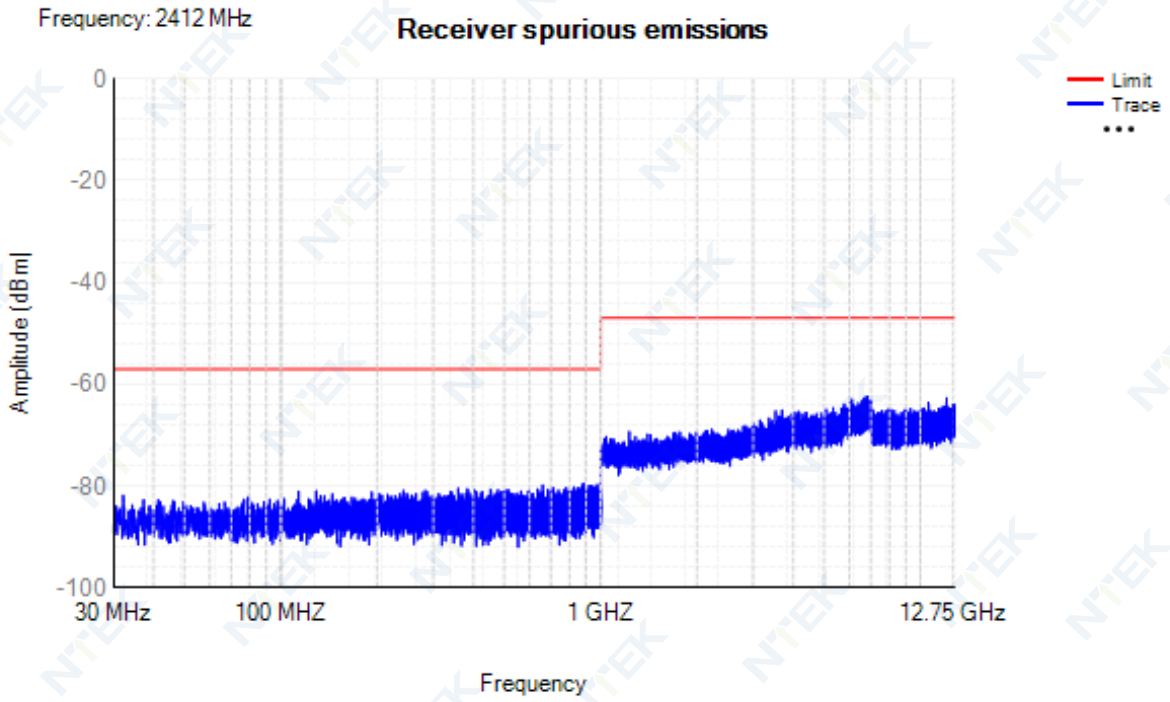

Rx. Spurious NVNT b 2442MHz Ant1

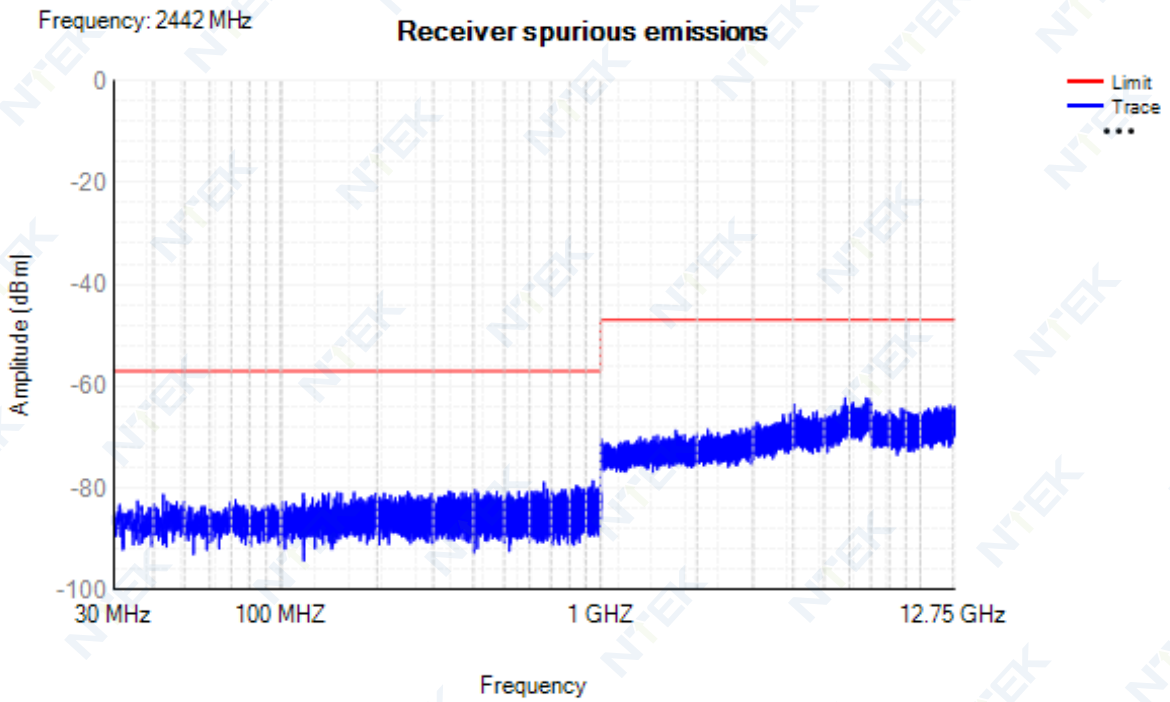

Rx. Spurious NVNT b 2472MHz Ant1

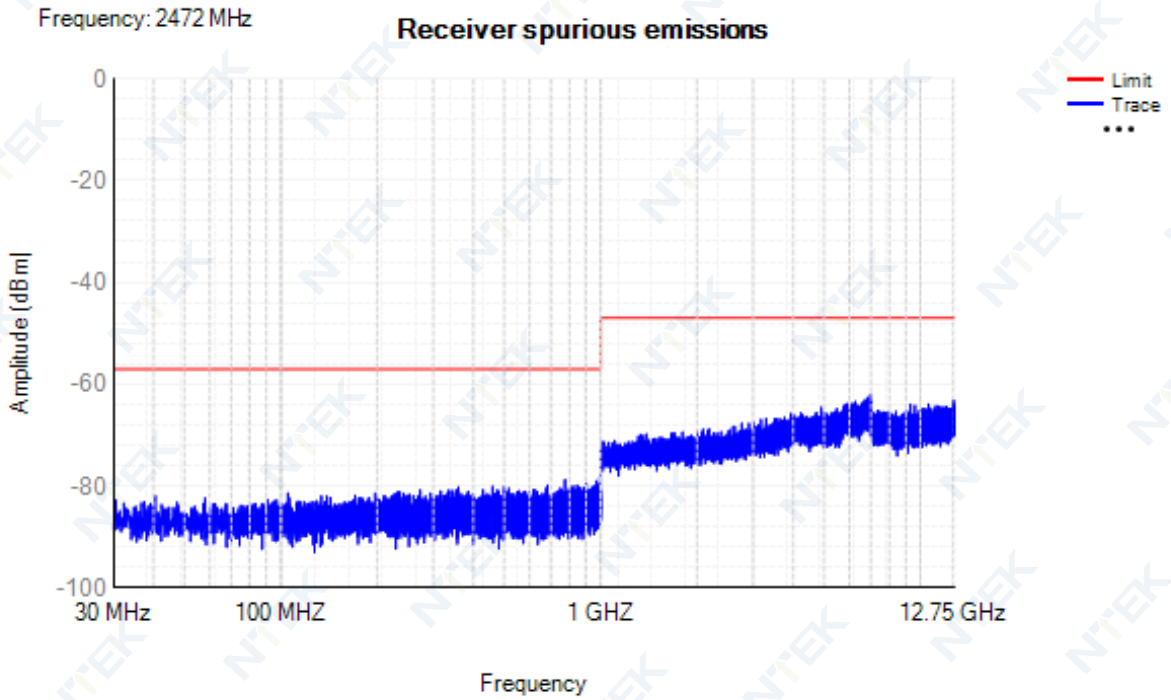

Rx. Spurious NVNT g 2412MHz Ant1

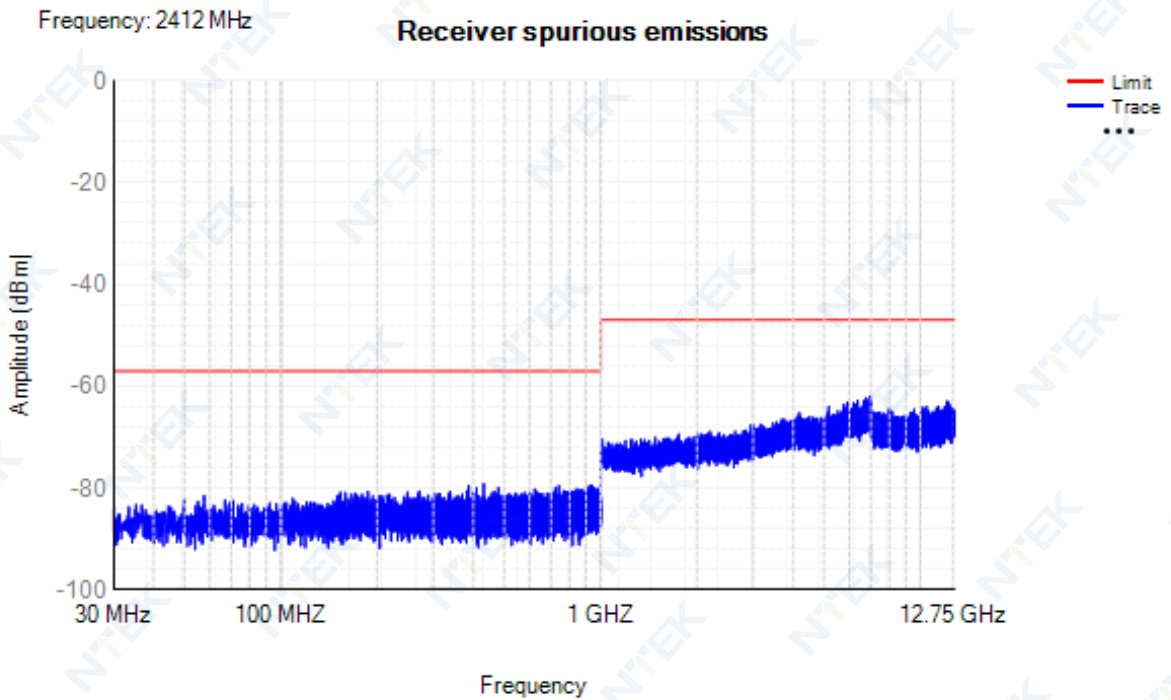

Rx. Spurious NVNT g 2442MHz Ant1

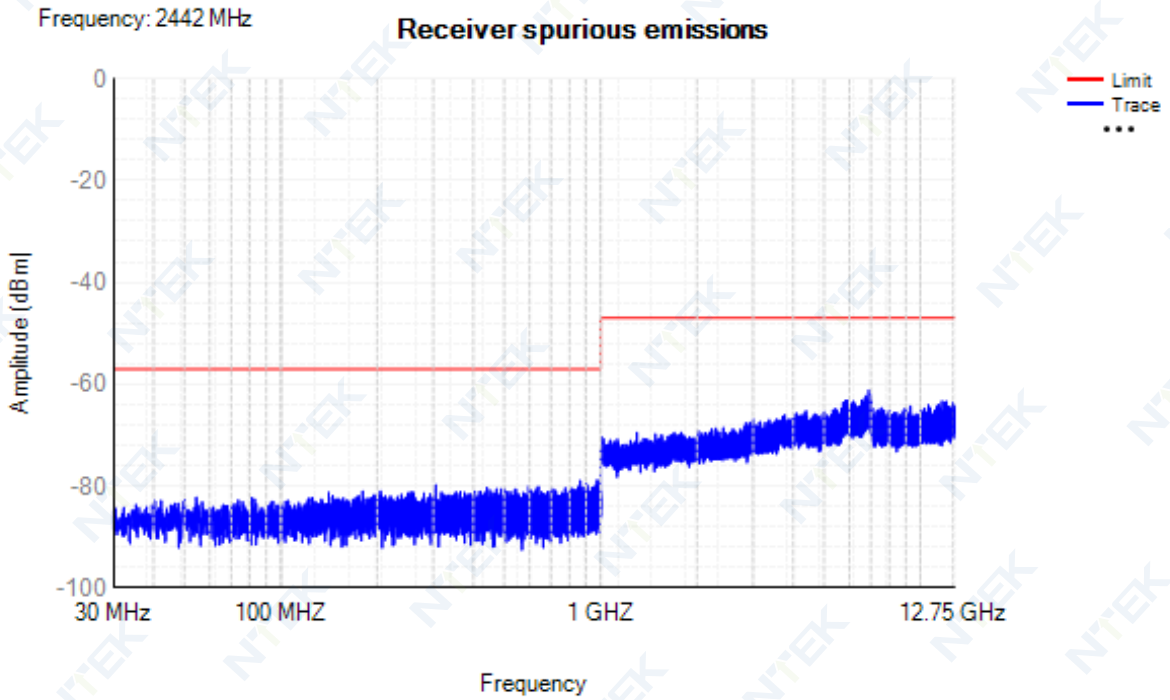

Rx. Spurious NVNT g 2472MHz Ant1

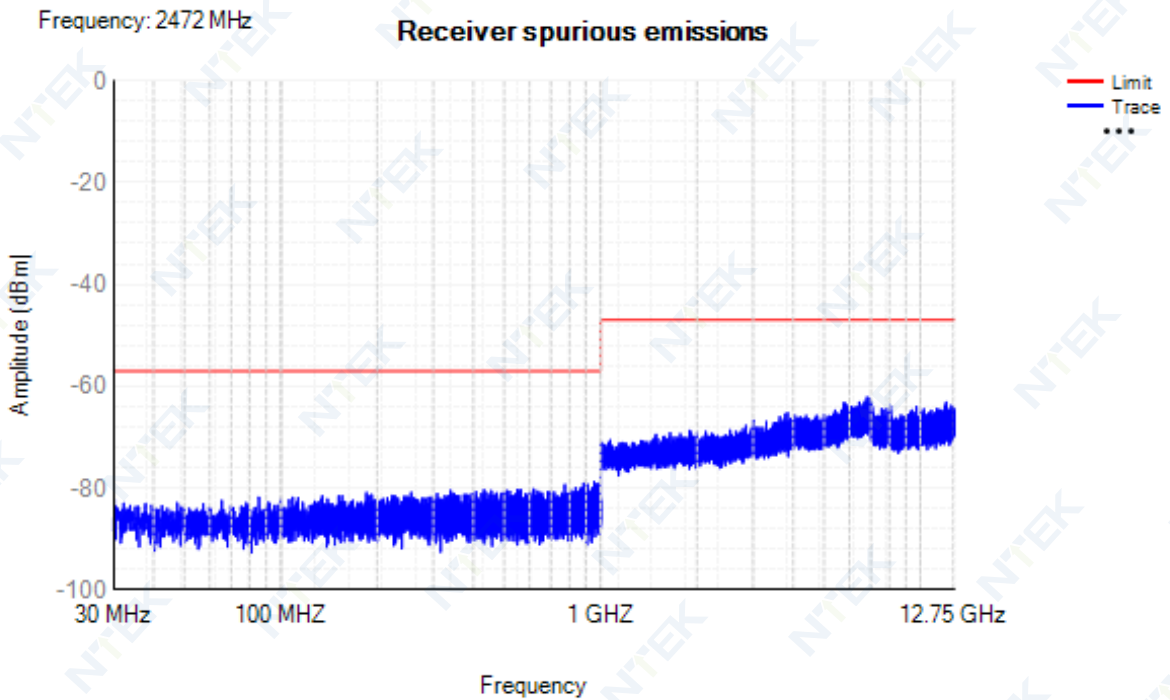

Rx. Spurious NVNT n20 2412MHz Ant1

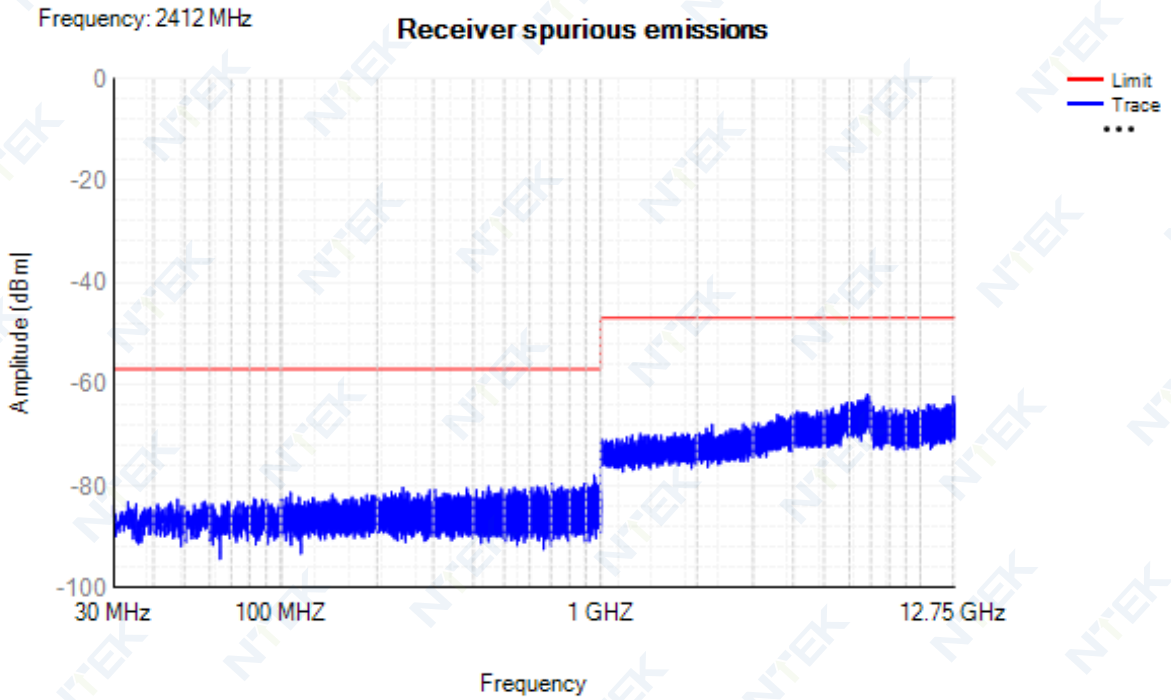

Rx. Spurious NVNT n20 2442MHz Ant1

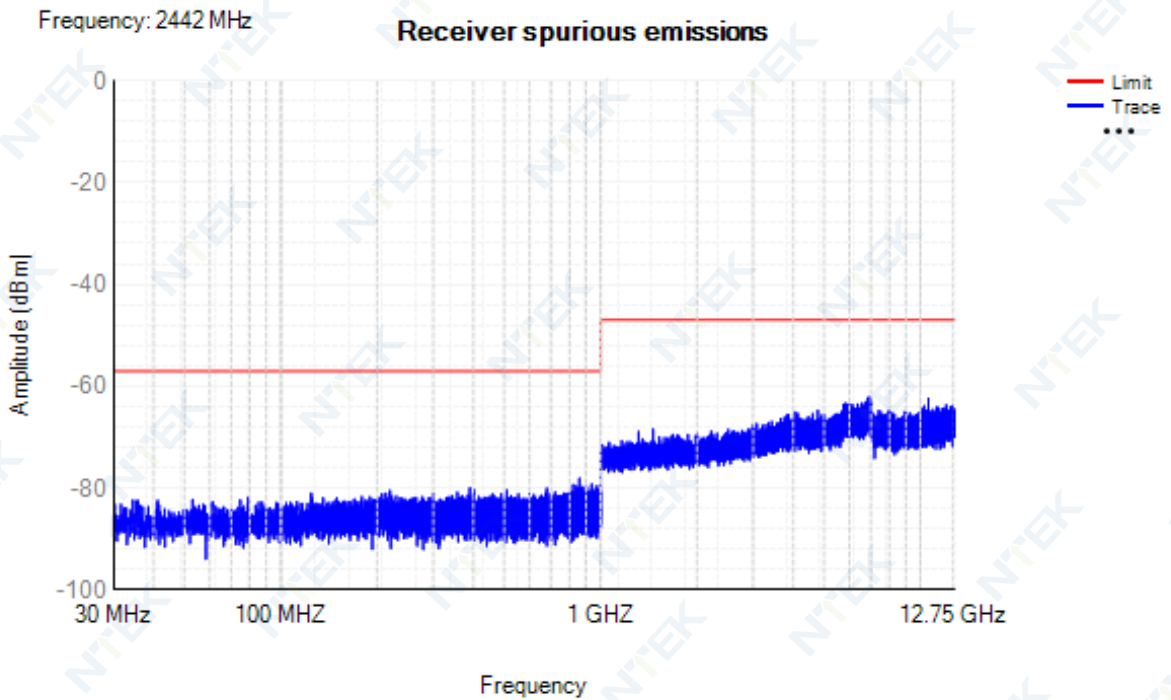

Rx. Spurious NVNT n20 2472MHz Ant1

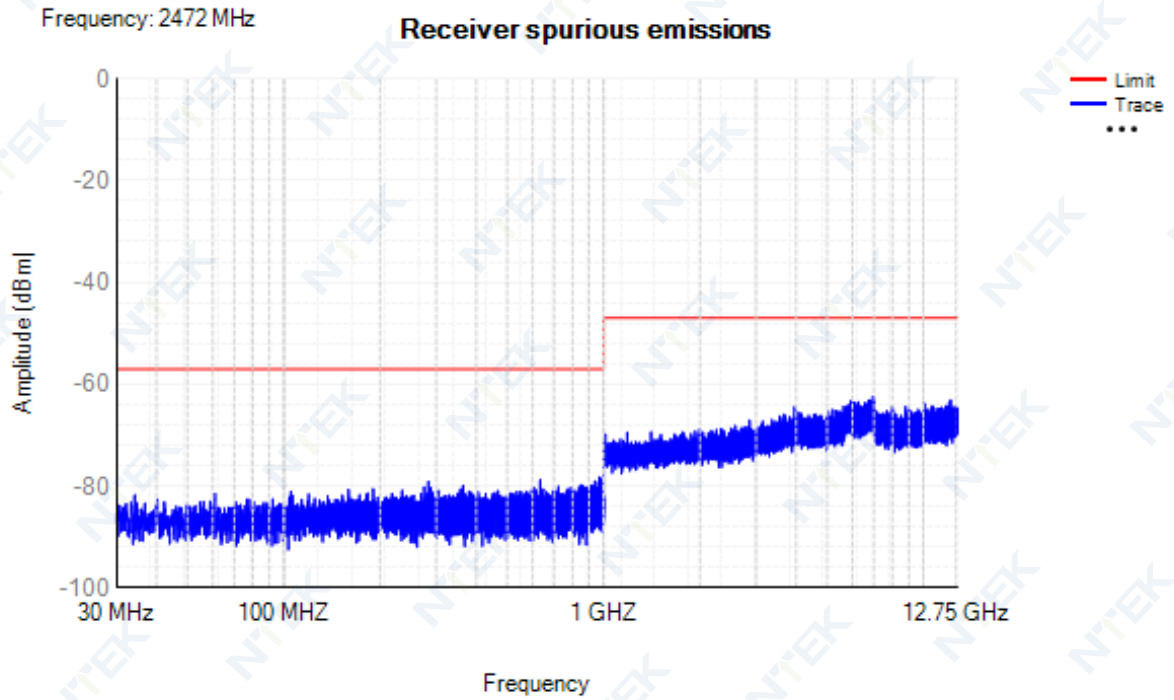

Rx. Spurious NVNT n40 2422MHz Ant1

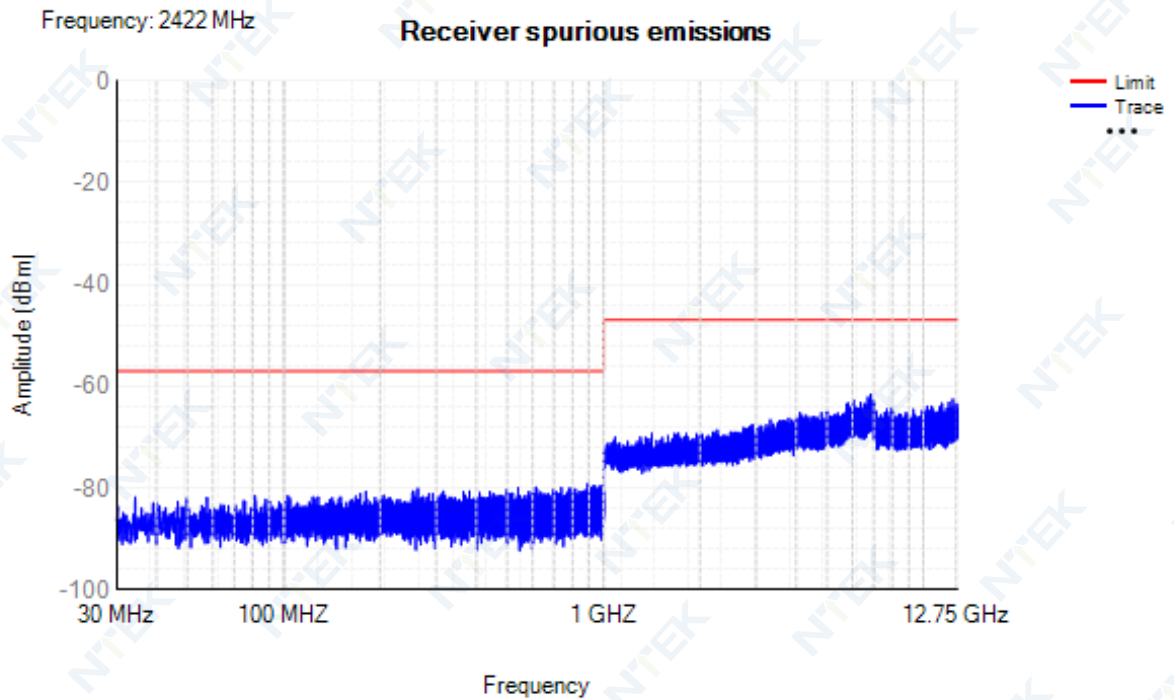

Rx. Spurious NVNT n40 2442MHz Ant1

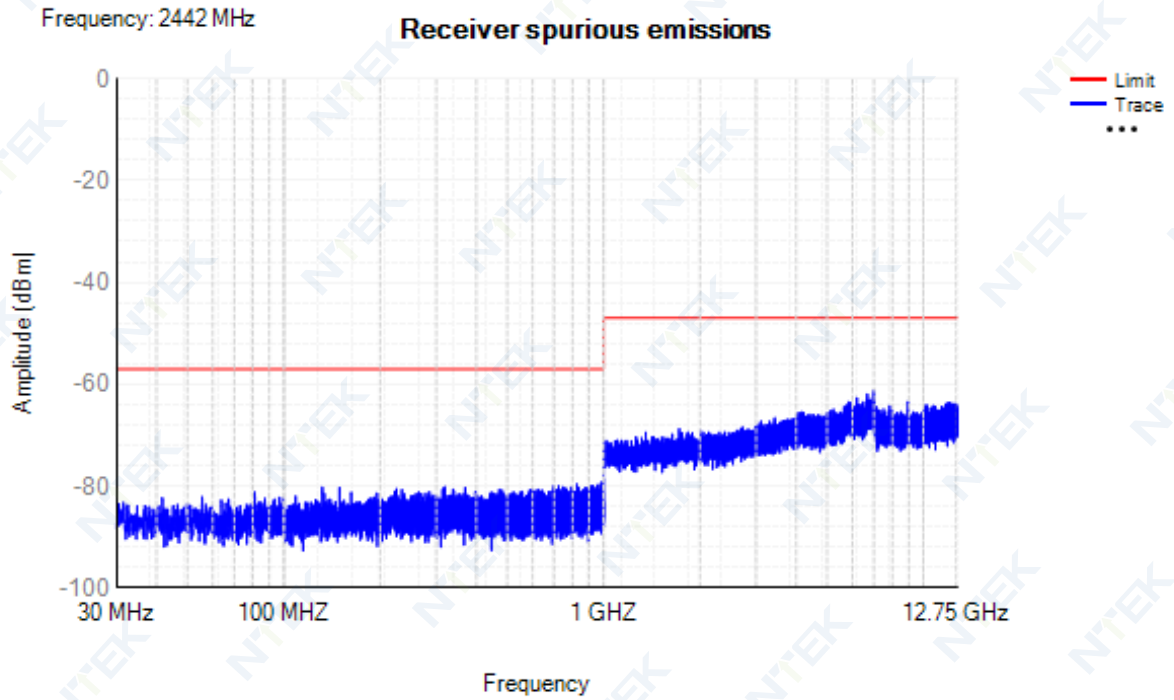

Rx. Spurious NVNT n40 2462MHz Ant1

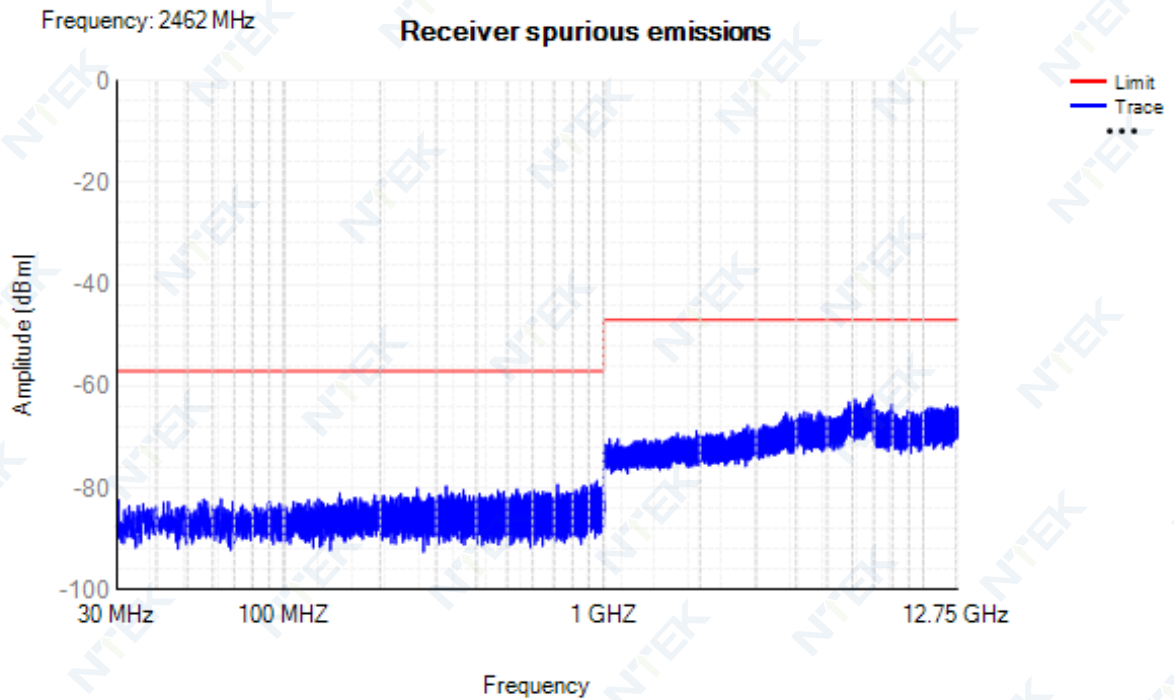

4.7 Adaptivity

Condition	Mode	Frequency (MHz)	AWGN Level (dBm/MHz)	CW Level (dBm)	Short Control Width (ms)	Short Control Ratio(%)	Limit (%)	Verdict
NVNT	802.11b	2412	-65.8	-35	1.73	3.46	<=10	Pass
NVNT	802.11b	2472	-65.15	-35	3.47	6.94	<=10	Pass
NVNT	802.11g	2412	-63.23	-35	1.73	3.46	<=10	Pass
NVNT	802.11g	2472	-63.7	-35	0.87	1.74	<=10	Pass
NVNT	802.11n(HT20)	2412	-61.19	-32	1.73	3.46	<=10	Pass
NVNT	802.11n(HT20)	2472	-61.4	-35	0	0	<=10	Pass
NVNT	802.11n(HT40)	2422	-60.06	-35	1.73	3.46	<=10	Pass
NVNT	802.11n(HT40)	2462	-60.36	-35	1.73	3.46	<=10	Pass

Adaptivity NVNT 802.11b 2412MHz

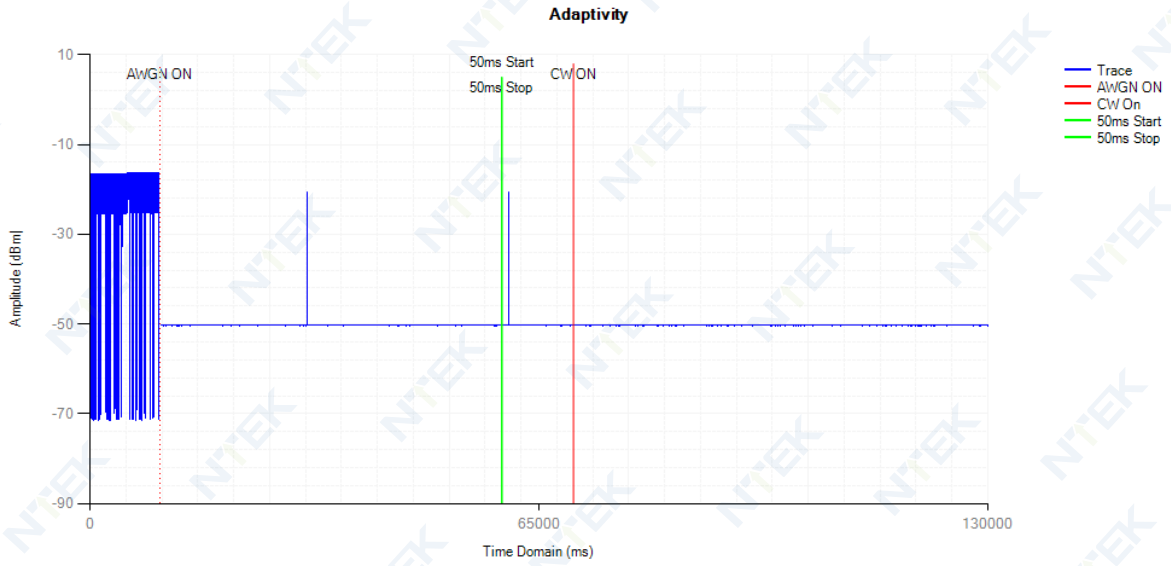

Control Signal NVNT 802.11b 2412MHz

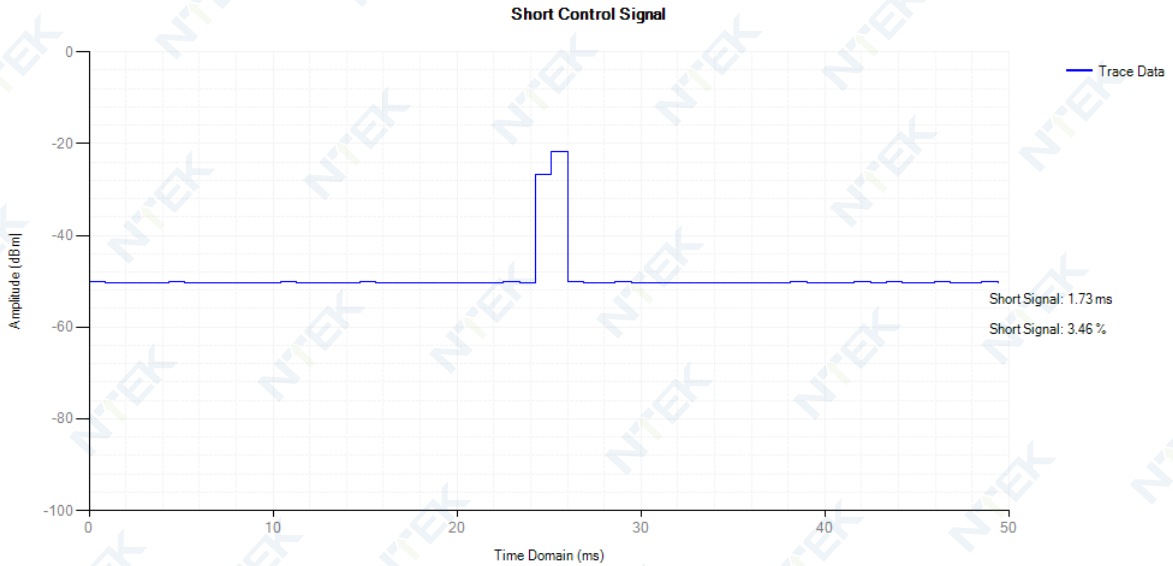

Adaptivity NVNT 802.11b 2472MHz

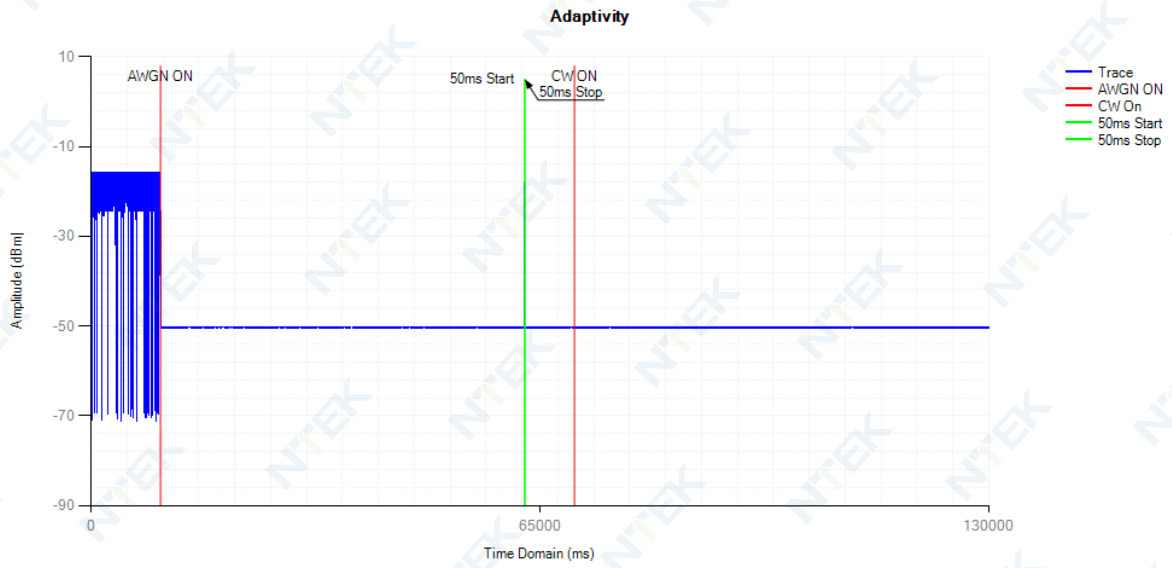

Control Signal NVNT 802.11b 2472MHz



Adaptivity NVNT 802.11g 2412MHz

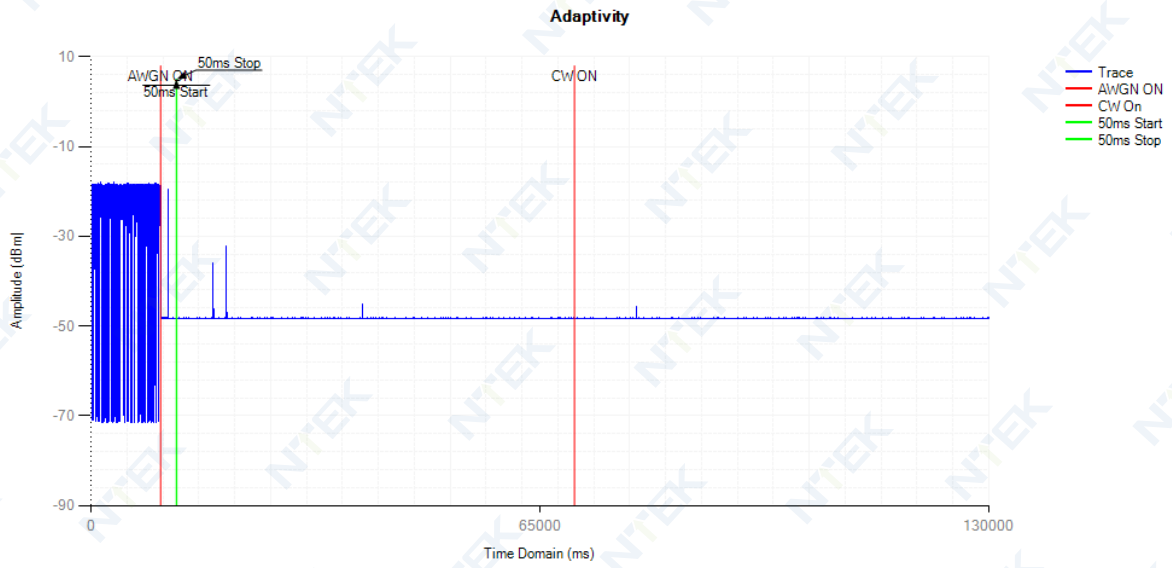

Control Signal NVNT 802.11g 2412MHz

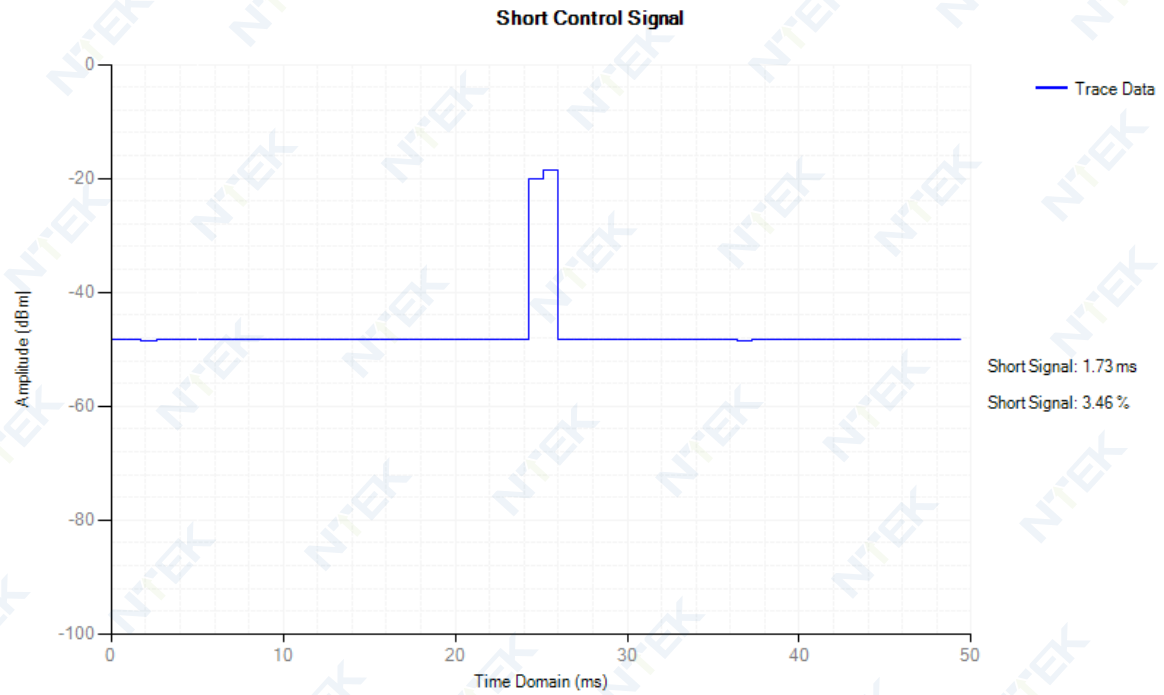

Adaptivity NVNT 802.11g 2472MHz

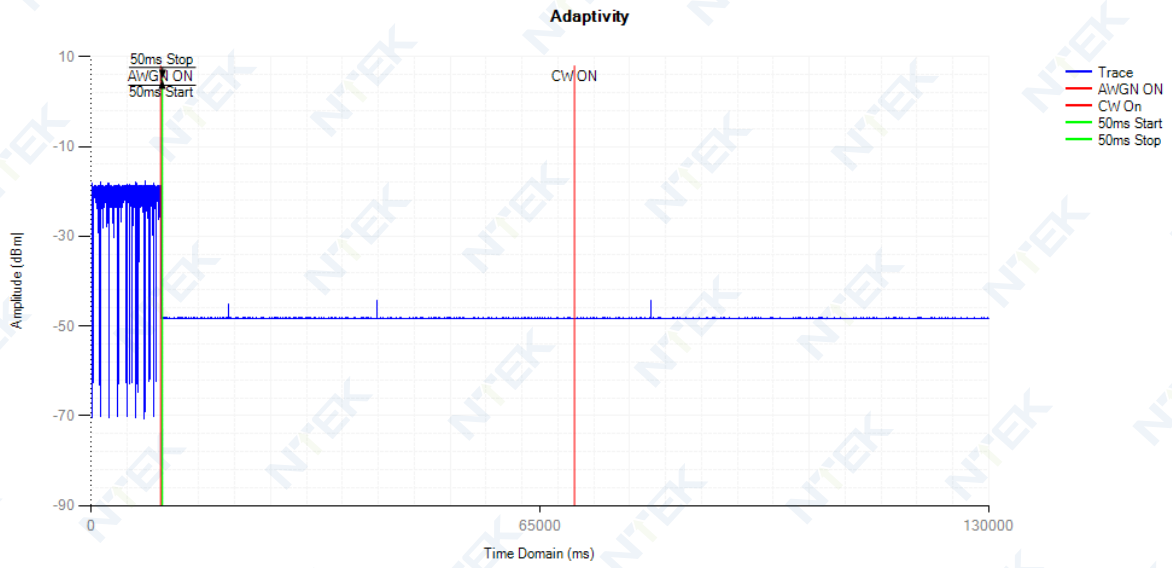

Control Signal NVNT 802.11g 2472MHz

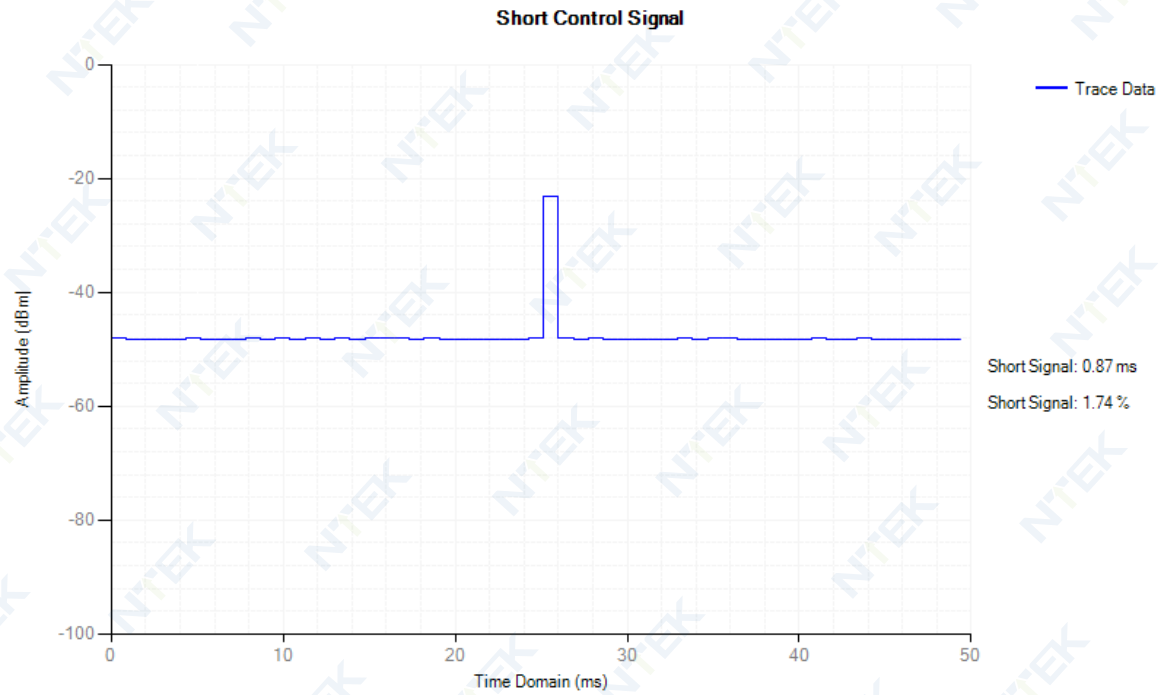

Adaptivity NVNT 802.11n(HT20) 2412MHz

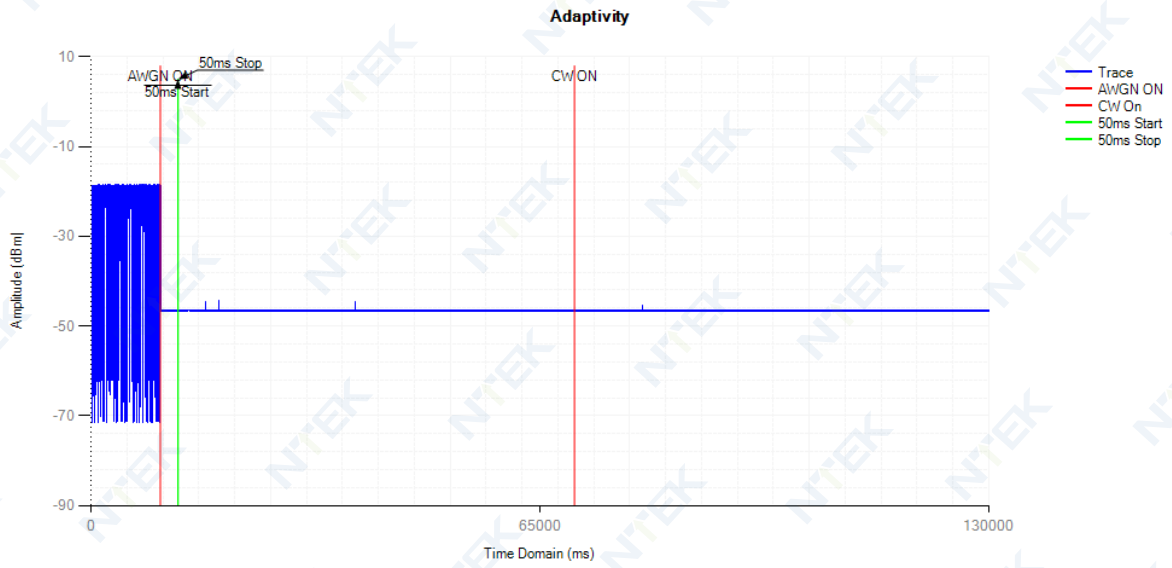

Control Signal NVNT 802.11n(HT20) 2412MHz

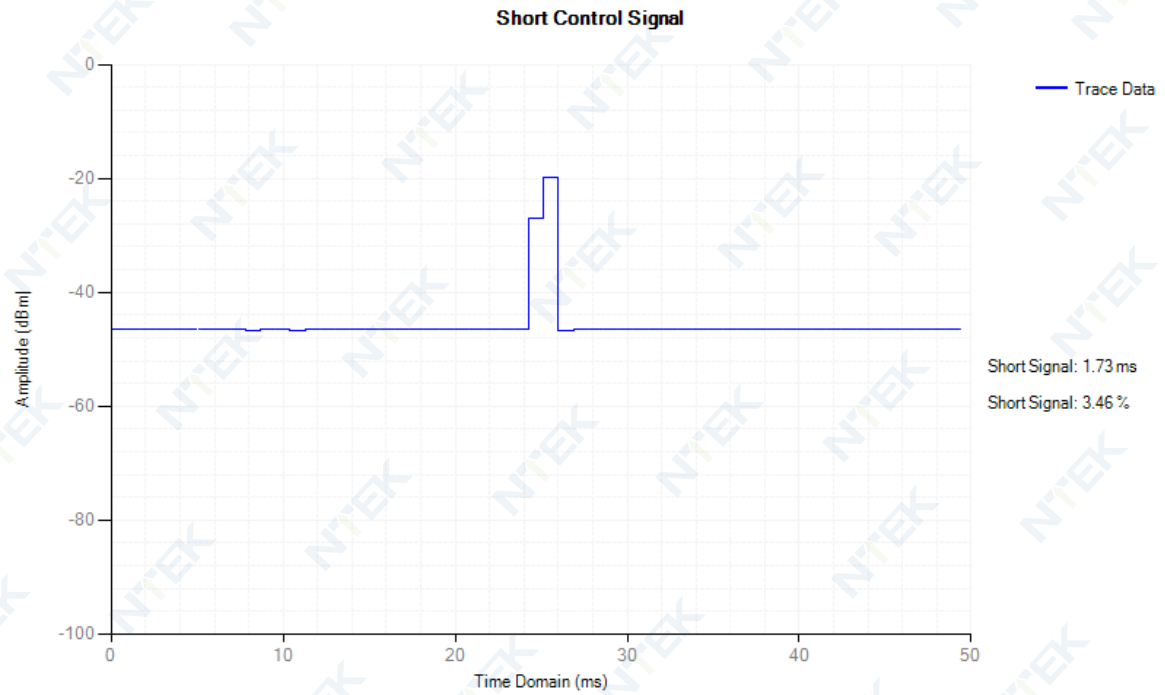

Adaptivity NVNT 802.11n(HT20) 2472MHz

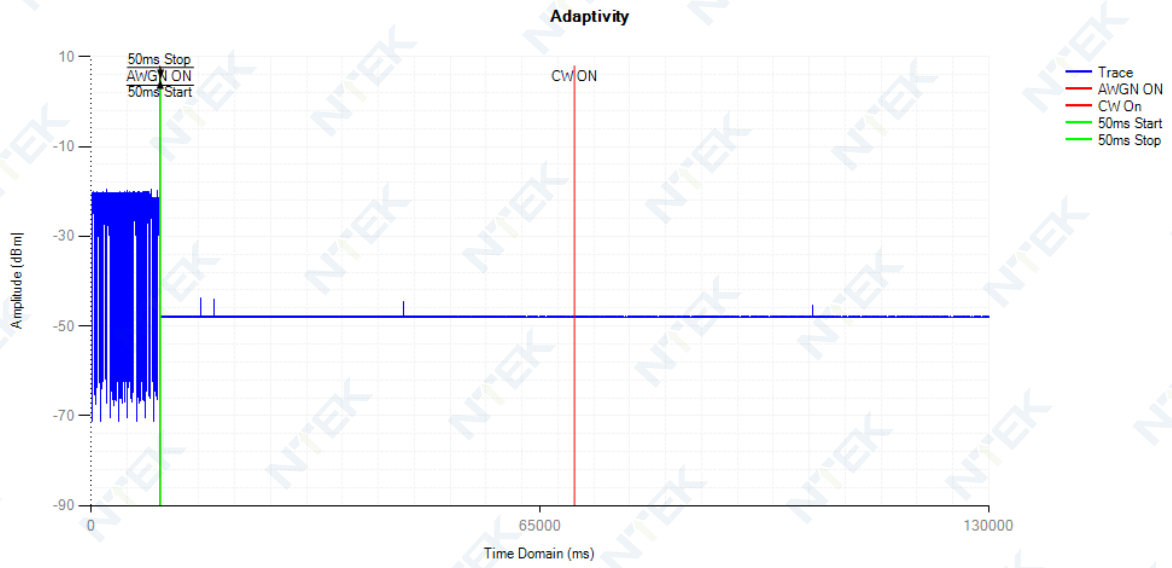

Control Signal NVNT 802.11n(HT20) 2472MHz

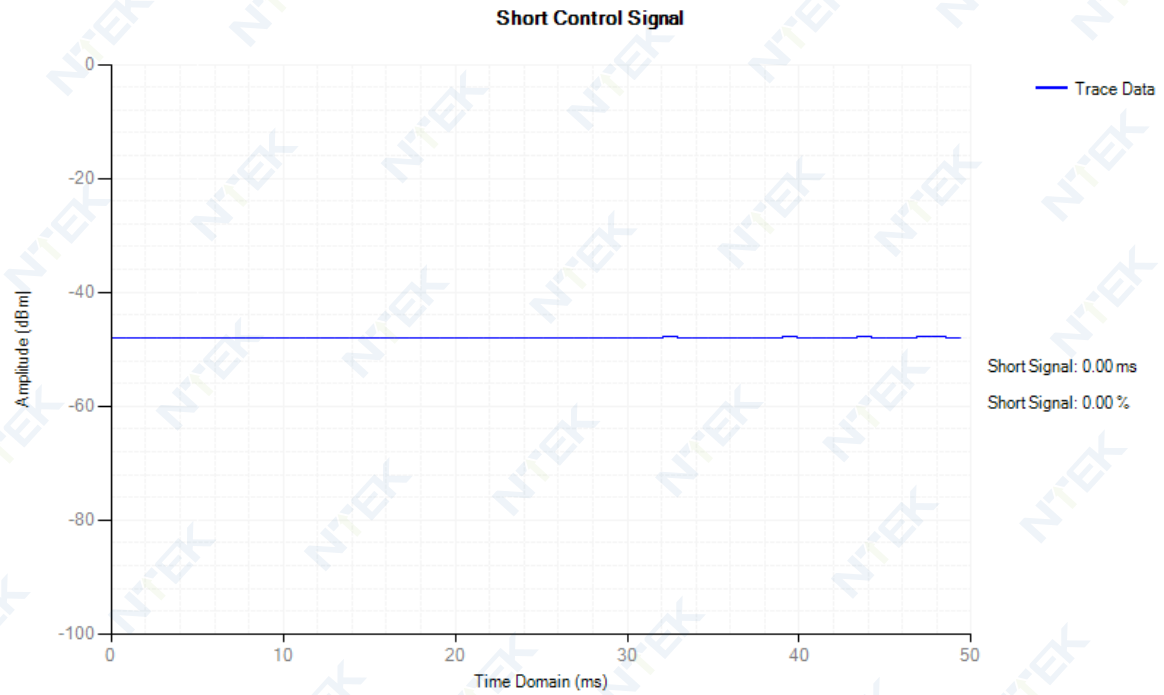

Adaptivity NVNT 802.11n(HT40) 2422MHz

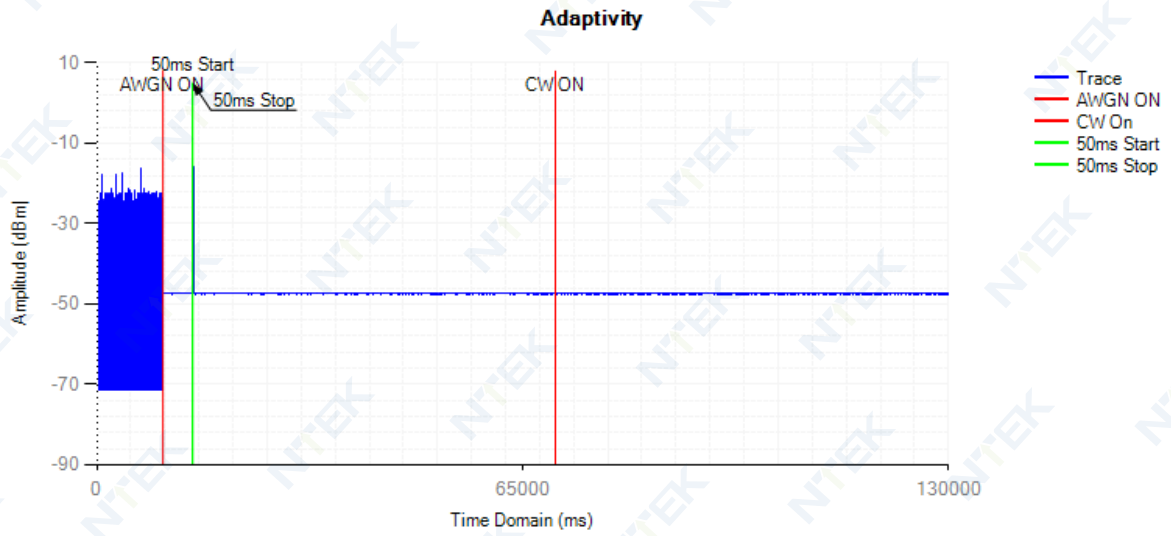

Control Signal NVNT 802.11n(HT40) 2422MHz

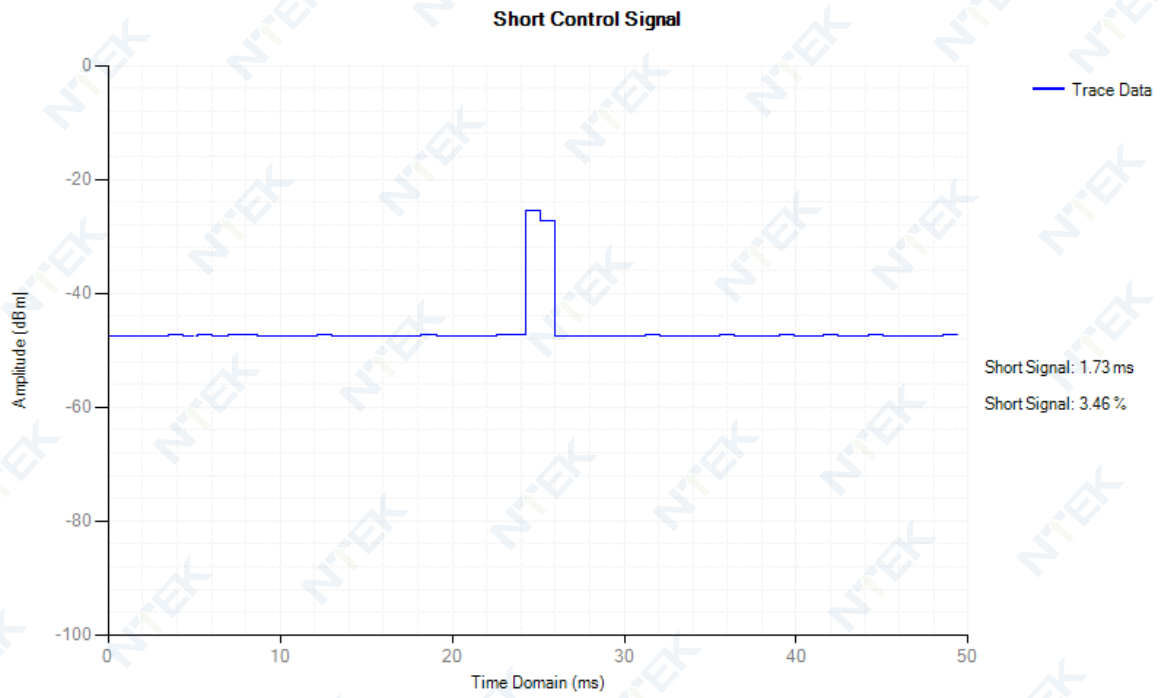

Adaptivity NVNT 802.11n(HT40) 2462MHz

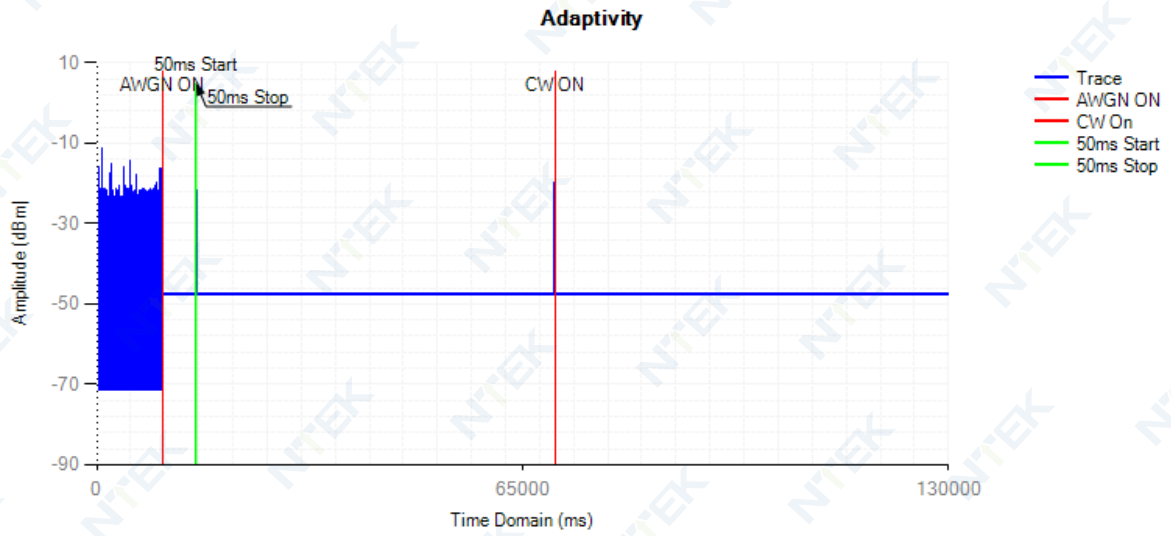

Control Signal NVNT 802.11n(HT40) 2462MHz

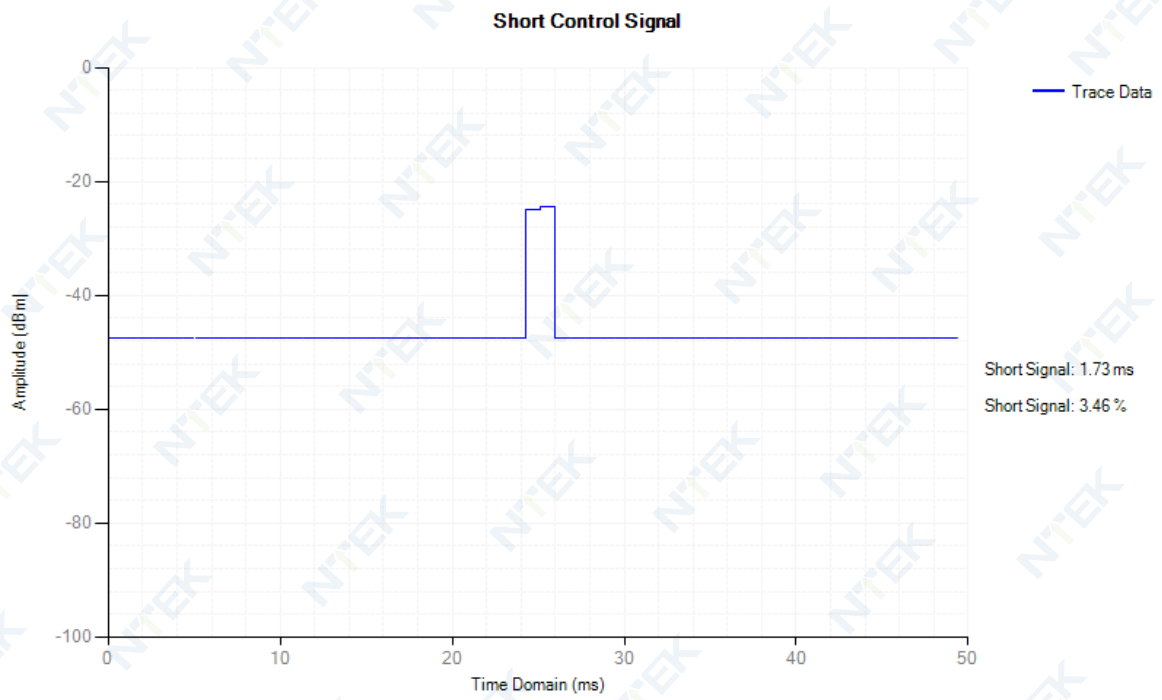

4.8 Adaptivity COT Channel Occupancy Time

Condition	Mode	Frequency (MHz)	Priority Class	Max COT (ms)	Limit COT (ms)	Min Idle Time (ms)	Limit Idle Time (ms)	Verdict
NVNT	802.11b	2412	1	1.212	<=13	0.04	>0.018	Pass
NVNT	802.11b	2472	1	2.327	<=13	0.04	>0.018	Pass
NVNT	802.11g	2412	1	0.28	<=13	0.035	>0.018	Pass
NVNT	802.11g	2472	1	0.252	<=13	0.037	>0.018	Pass
NVNT	802.11n(HT20)	2412	1	5.43	<=13	0.037	>0.018	Pass
NVNT	802.11n(HT20)	2472	1	5.398	<=13	0.037	>0.018	Pass
NVNT	802.11n(HT40)	2422	1	0.045	<=13	0.097	>0.018	Pass
NVNT	802.11n(HT40)	2462	1	0.432	<=13	0.045	>0.018	Pass

COT NVNT 802.11b 2412MHz

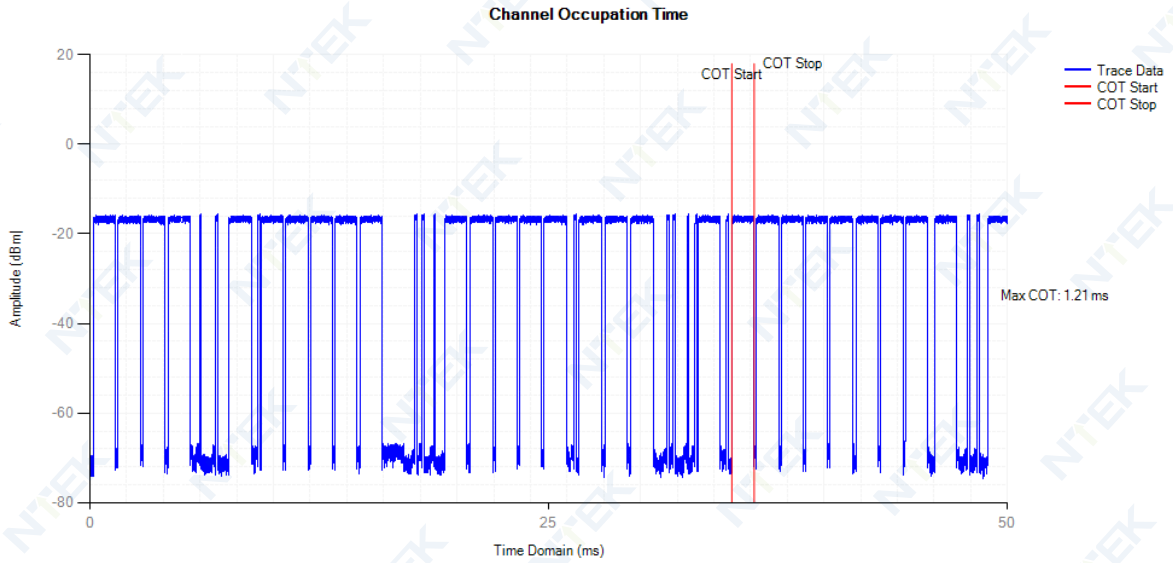

Idle NVNT 802.11b 2412MHz

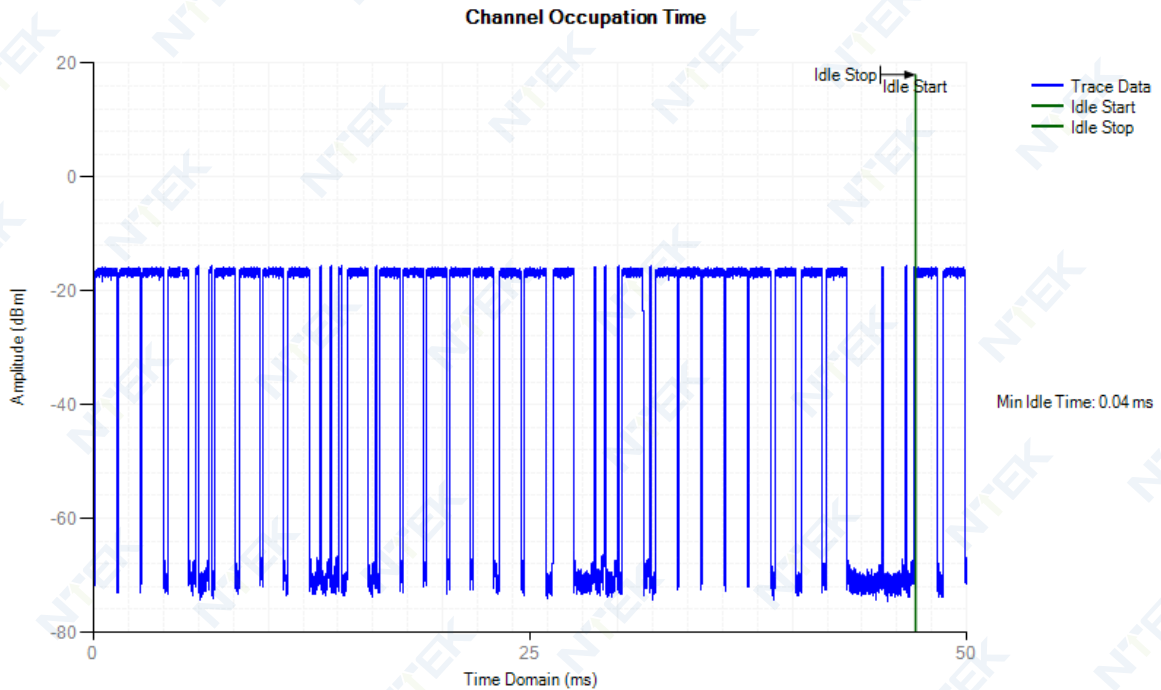

COT NVNT 802.11b 2472MHz

Channel Occupation Time

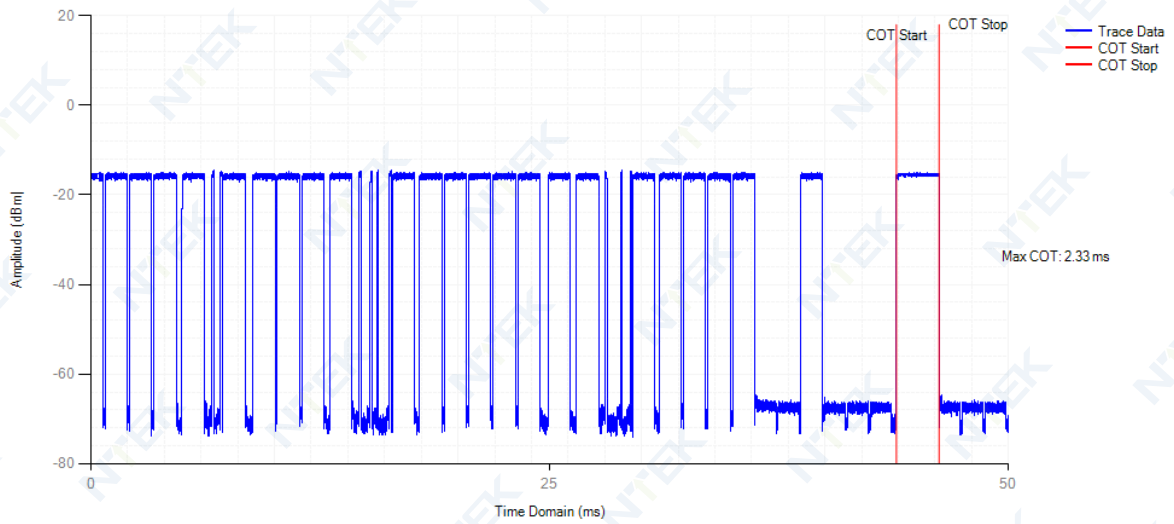

Idle NVNT 802.11b 2472MHz

Channel Occupation Time

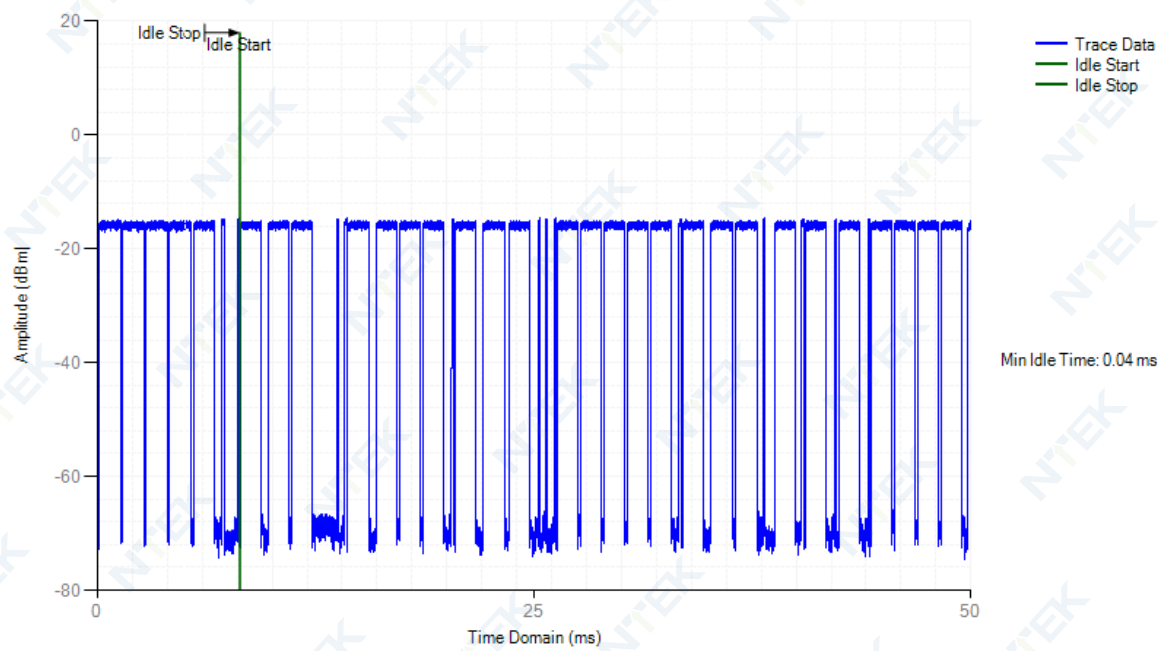

COT NVNT 802.11g 2412MHz

Channel Occupation Time

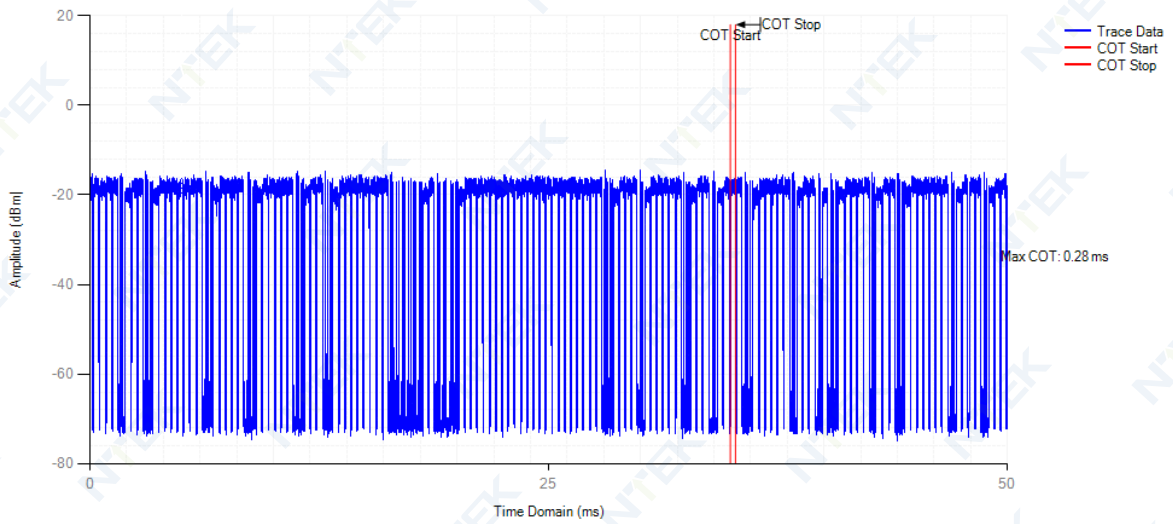

Idle NVNT 802.11g 2412MHz

Channel Occupation Time

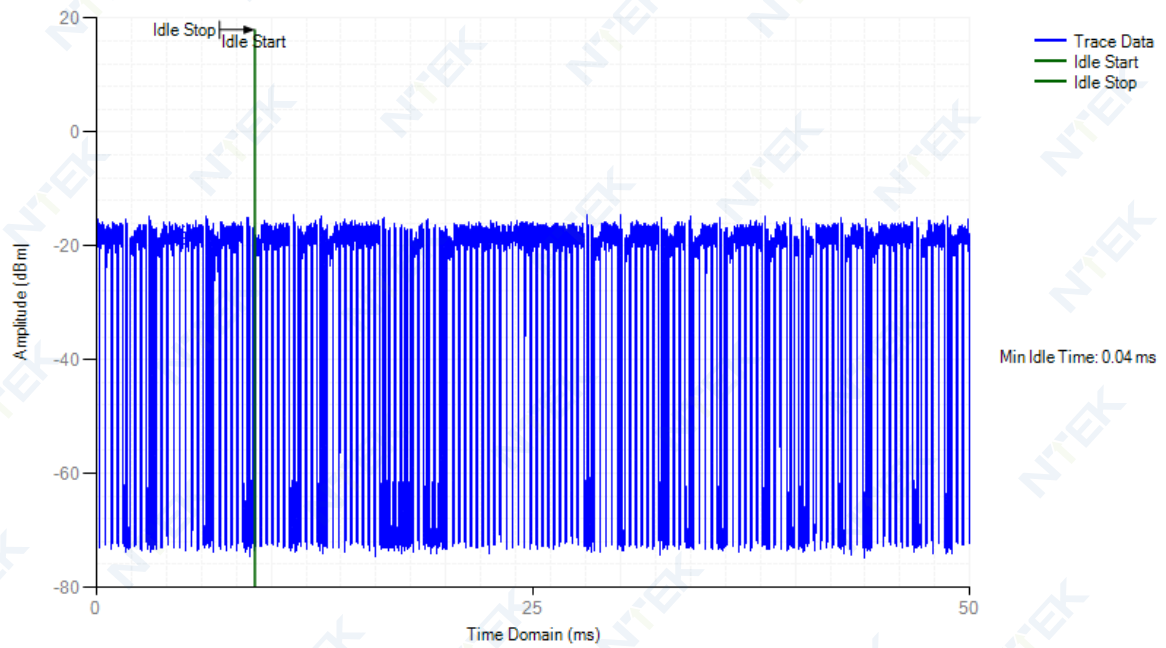

COT NVNT 802.11g 2472MHz

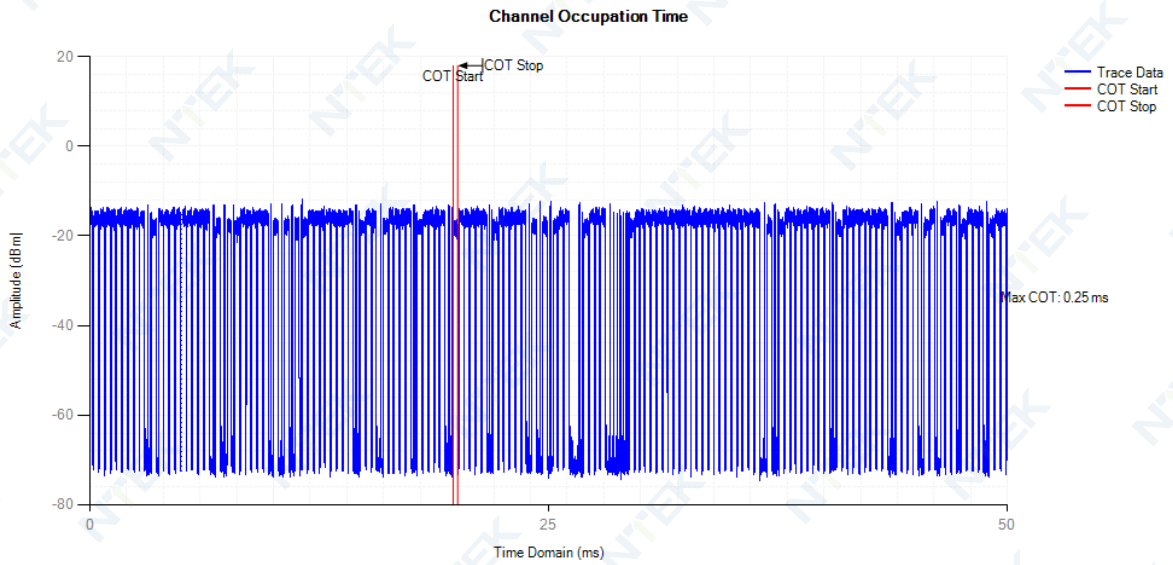

Idle NVNT 802.11g 2472MHz

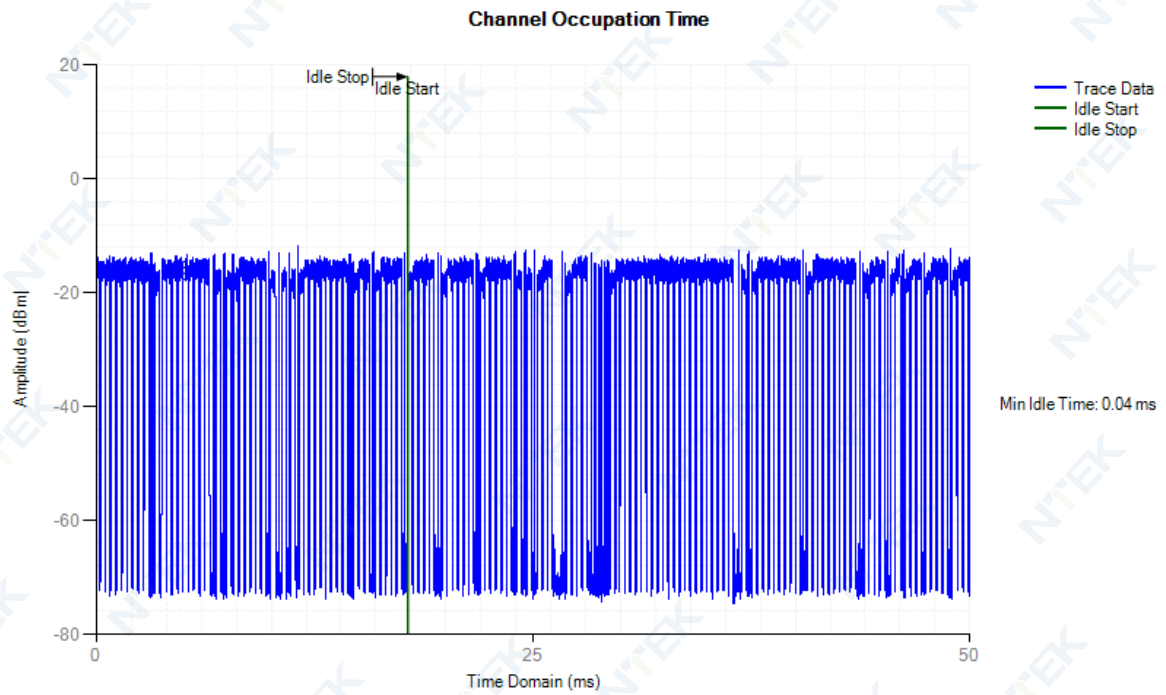

COT NVNT 802.11n(HT20) 2412MHz

Channel Occupation Time

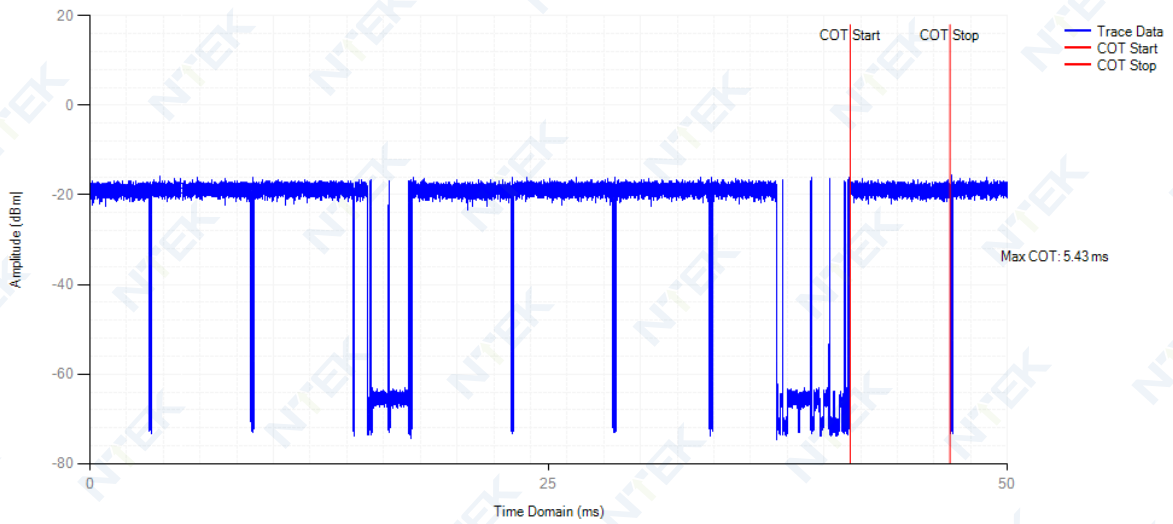

Idle NVNT 802.11n(HT20) 2412MHz

Channel Occupation Time

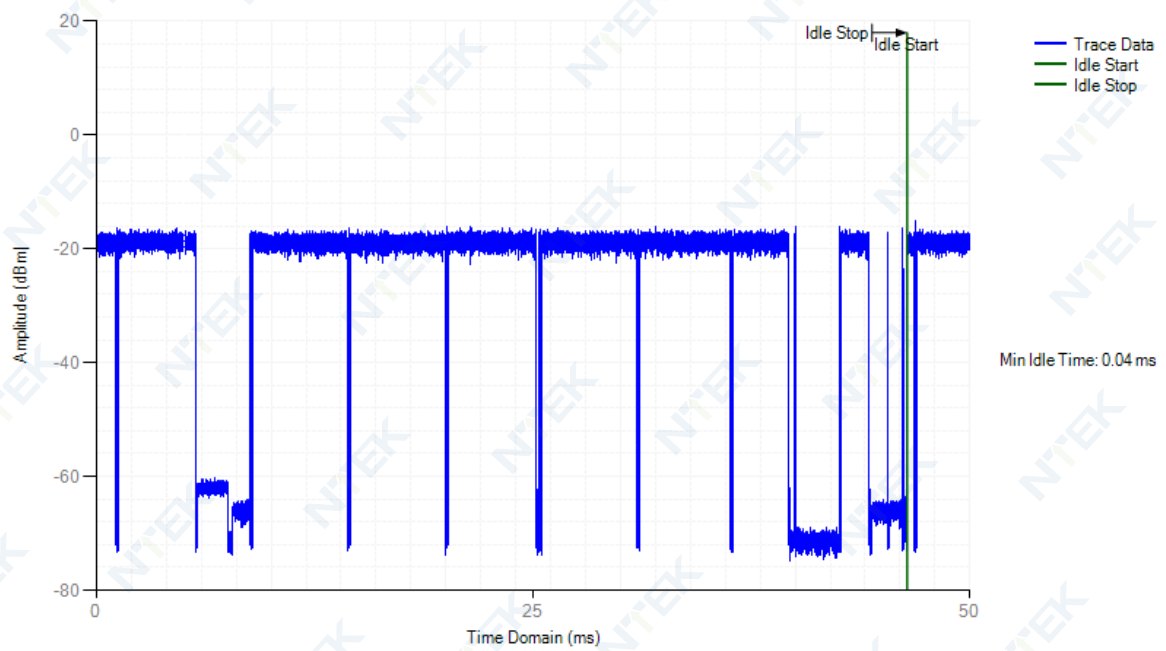

COT NVNT 802.11n(HT20) 2472MHz

Channel Occupation Time

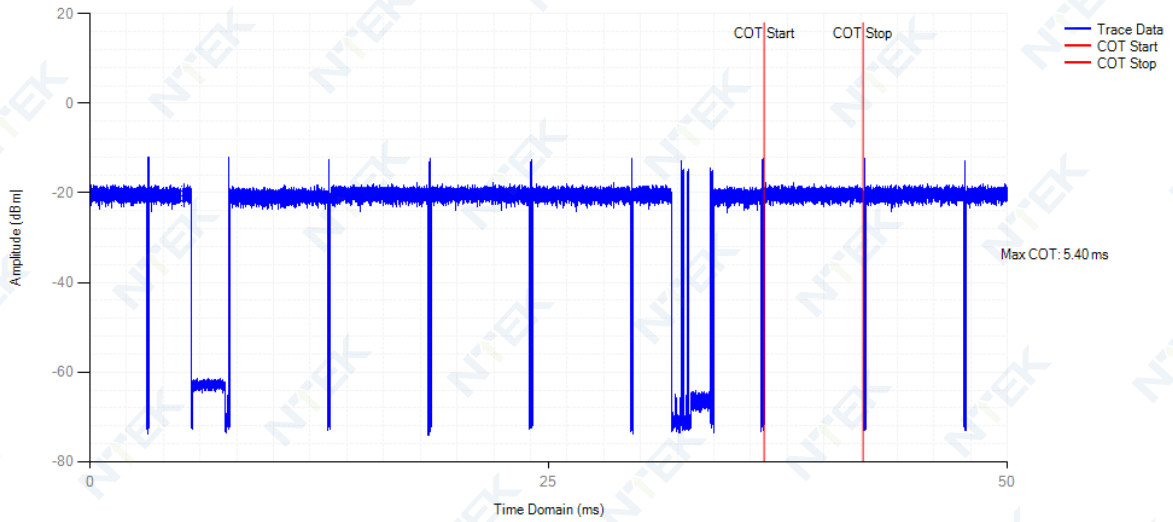

Idle NVNT 802.11n(HT20) 2472MHz

Channel Occupation Time

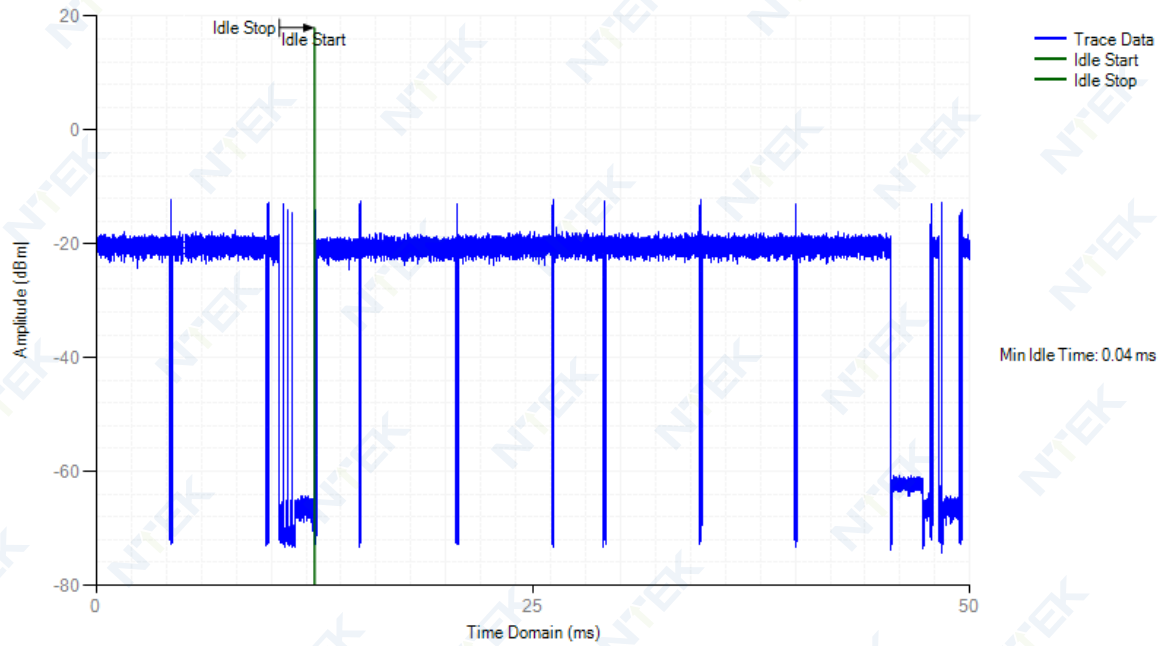

COT NVNT 802.11n(HT40) 2422MHz

Channel Occupation Time

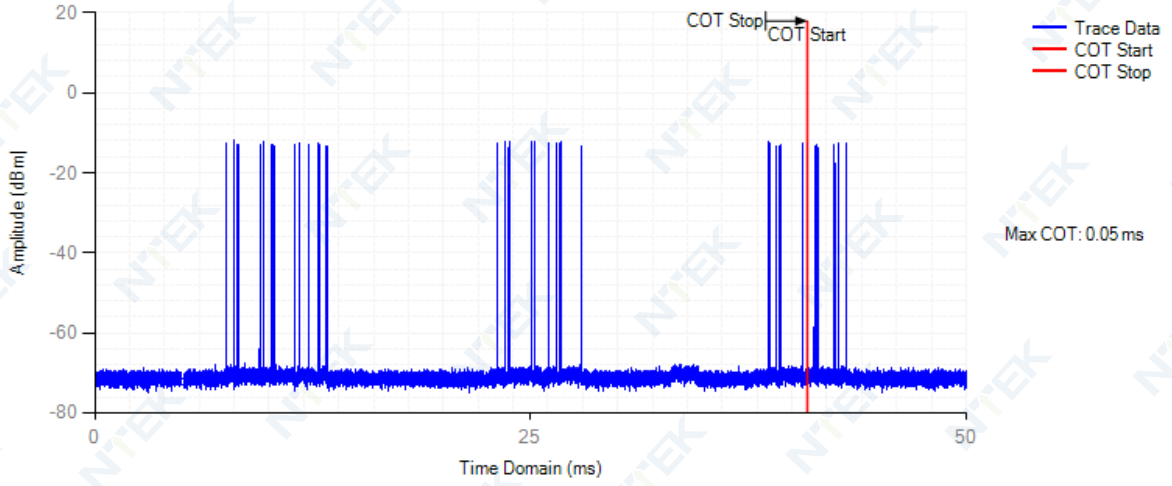

Idle NVNT 802.11n(HT40) 2422MHz

Channel Occupation Time

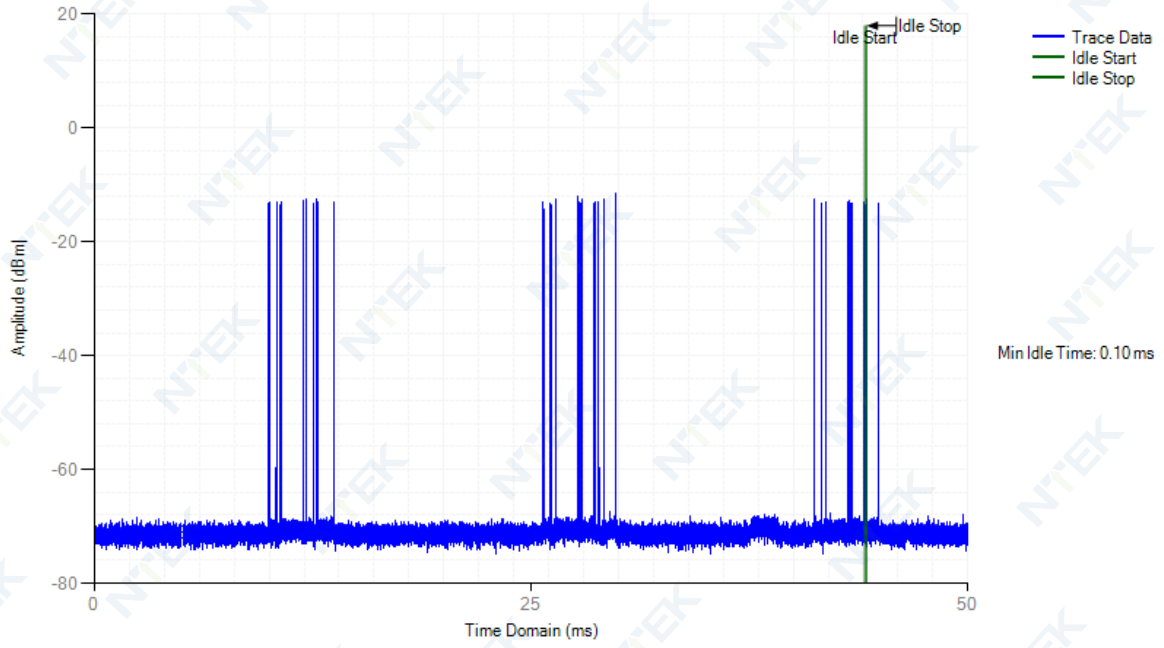

COT NVNT 802.11n(HT40) 2462MHz

Channel Occupation Time

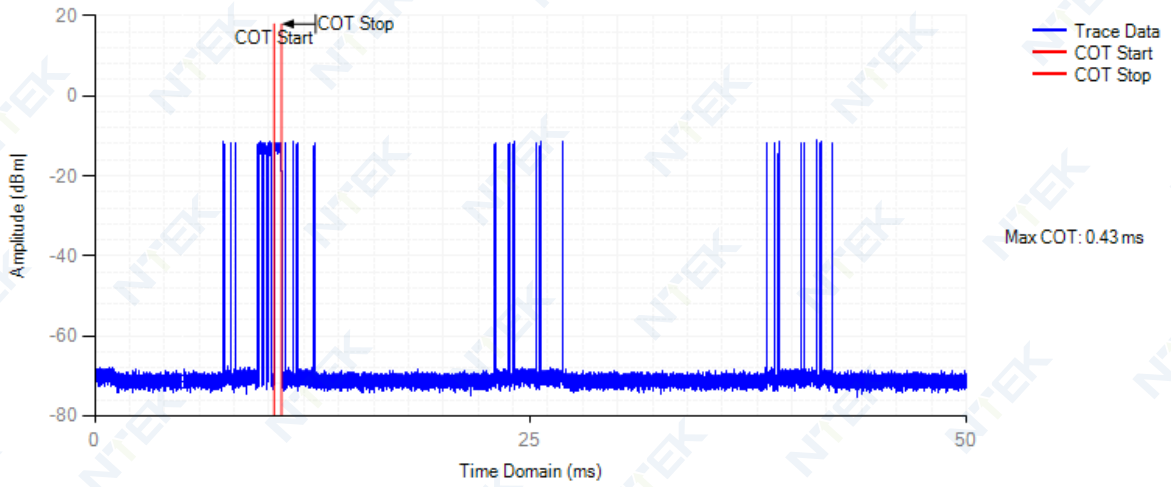

Idle NVNT 802.11n(HT40) 2462MHz

Channel Occupation Time

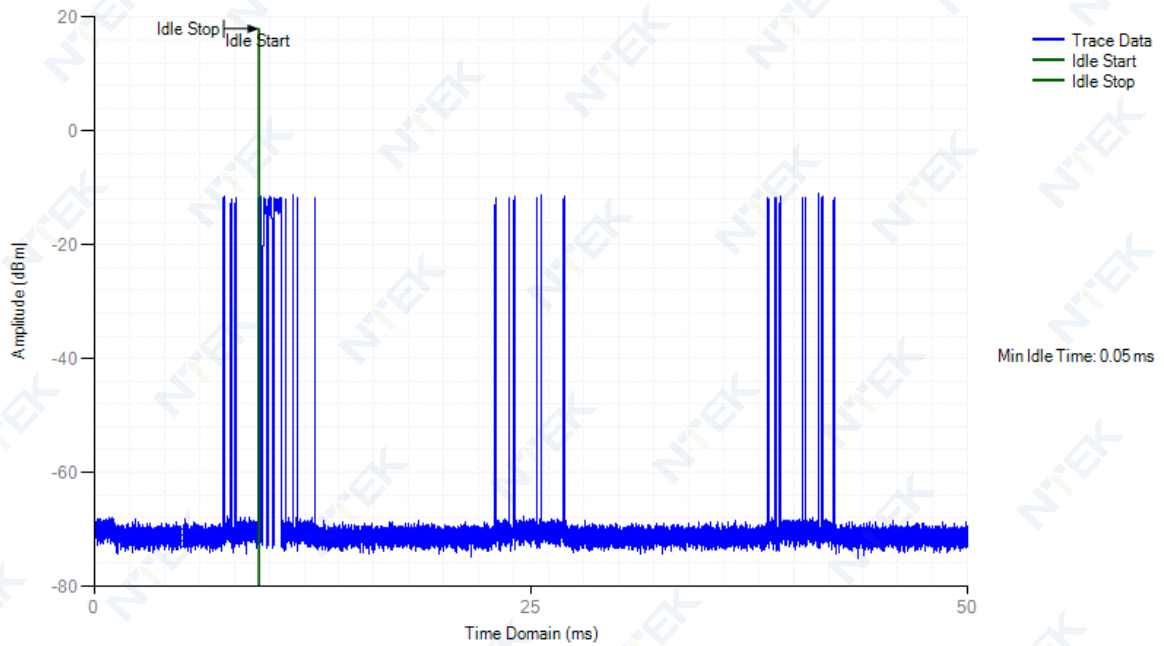

5. EUT TEST PHOTO

SPURIOUS EMISSIONS MEASUREMENT PHOTOS

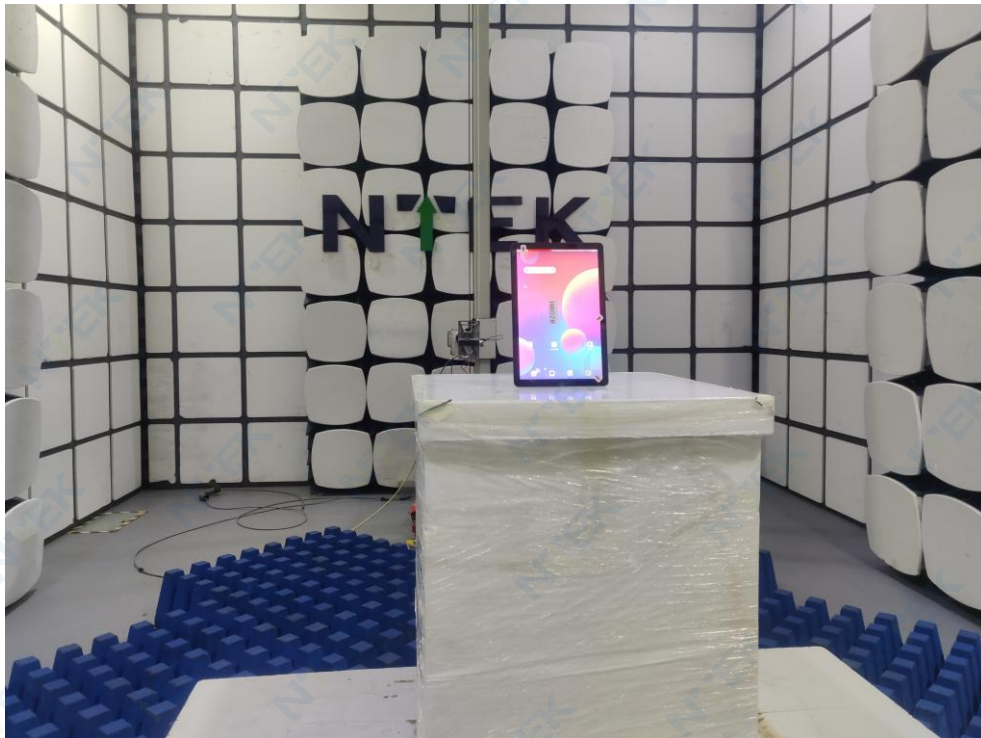
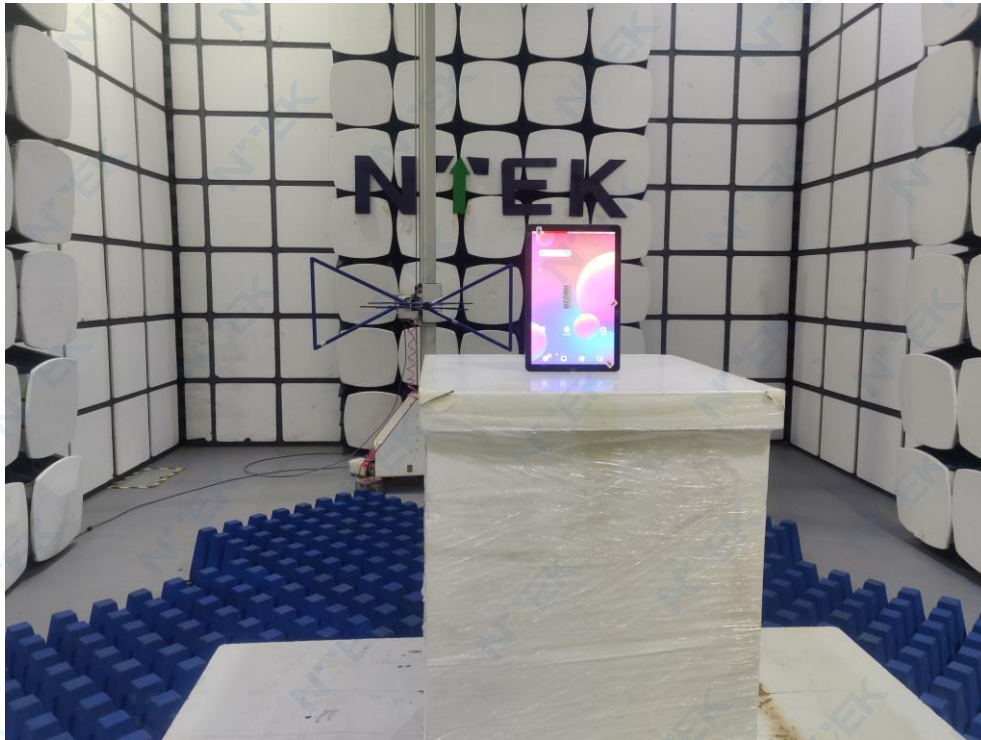

END OF REPORT