

EMC TEST REPORT

The device described below is tested by Dongguan Nore Testing Center Co., Ltd. to determine the maximum emission levels emanating from the device, the severe levels which the device can endure and E.U.T.'s performance criterion. The test results are contained in this test report. Dongguan Nore Testing Center Co., Ltd. is assumed of full responsibility for the accuracy and completeness of these tests.

Applicant : SHENZHEN FENDA TECHNOLOGY CO., LTD.
Address : Fenda Hi-Tech Park, Zhoushi Road, Shiyao Town, Baoan District, Shenzhen City, Guangdong, China
Manufacturer/Factory : SHENZHEN FENDA TECHNOLOGY CO., LTD.
Address : Fenda Hi-Tech Park, Zhoushi Road, Shiyao Town, Baoan District, Shenzhen City, Guangdong, China
E.U.T. : 5.1 Speaker System
Brand Name : F&D
Model No. : F5060X, F5080X, 5090X, F6000X, F6600X
(For model difference refer to section 2.1)
Measurement Standard : EN 55032: 2015
EN 61000-3-2: 2014, EN 61000-3-3: 2013
EN 55020: 2007+A11: 2011
(EN 61000-4-2: 2009, EN 61000-4-3: 2006+A2: 2010,
EN 61000-4-4: 2012)
Date of Receiver : November 28, 2016
Date of Test : November 29, 2016 to December 19, 2016
Date of Report : December 19, 2016

This Test Report is Issued Under the Authority of :

Prepared by

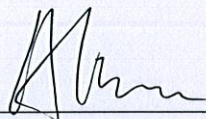

Alina Guo / Engineer

Approved / Authorized Signer



Iori Fan / Authorized Signatory

This report shows that the E.U.T. is technically compliant with the EN 55032, EN 61000-3-2, EN 61000-3-3 and EN 55020. This report applies to above tested sample only and shall not be reproduced in part without written approval of Dongguan Nore Testing Center Co., Ltd.

TABLE OF CONTENT

1. SUMMARY OF TEST RESULTS.....	5
2. GENERAL INFORMATION	6
2.1 Details of E.U.T.	6
2.2 Description of Support Device	7
2.3 Block Diagram of Test Setup	7
2.4 Test Facility	8
2.5 Abnormalities from Standard Conditions	8
3. MEASURING DEVICES AND TEST EQUIPMENT	9
3.1 For Mains terminals Disturbance voltage test	9
3.2 For Radiated Emission Measurement	9
3.3 For Harmonic / Flicker Measurement	9
3.4 For Electrostatic Discharge Test.....	9
3.5 For RF Electromagnetic Field Immunity Test.....	10
3.6 For Electrical Fast Transient /Burst Immunity Test.....	10
3.7 For EN55020 Immunity Test	10
4. MAINS TERMINAL DISTURBANCE VOLTAGE MEASUREMENT.....	11
4.1 Block Diagram of Test Setup	11
4.2 Limit of Mains Terminal Disturbance voltage measurement.....	11
4.3 Test Procedure	12
4.4 Operating Condition of E.U.T.....	12
4.5 Mains Terminal Disturbance Voltage Test Results.....	12
5. RADIATED EMISSION MEASUREMENT	15
5.1 Block Diagram of Test	15
5.2 Limit of Radiated Emission Measurement	15
5.3 Test Procedure	16
5.4 Operating Condition of E.U.T.....	16
5.5 Radiated Emission Measurement Result	16
6. HARMONIC CURRENT EMISSION TEST	19
6.1 Block Diagram of Test Setup	19
6.2 Limits of Harmonics current measurement.....	19
6.3 Test Procedure	20
6.4 Operating Condition of E.U.T.....	20
6.5 Test Results.....	20
7. VOLTAGE FLUCTUATIONS & FLICKER TEST	21
7.1 Block Diagram of Test Setup	21
7.2 Limits of Voltage Fluctuations & Flicker Measurement.....	21
7.3 Test Procedure	21
7.4 Operating Condition of E.U.T.....	21
7.5 Test Results.....	22
8. PERFORMANCE CRITERIA FOR IMMUNITY	24
9. ELECTROSTATIC DISCHARGE IMMUNITY TEST	25
9.1 Block Diagram of Test Setup	25
9.2 Test Standard and Severity Levels	25
9.3 Test Procedure	26
9.4 Test Results.....	26
10. RF FIELD (KEYED CARRIER) STRENGTH SUSCEPTIBILITY TEST (S5)	28
10.1 Block Diagram of Test Setup	28
10.2 Test Standard and Severity Levels	28
10.3 Test Procedure	29
10.4 Test Results.....	29

11. ELECTRICAL FAST TRANSIENT/BURST IMMUNITY TEST	31
11.1 Block Diagram of Test Setup.....	31
11.2 Test Standard and Severity Levels.....	31
11.3 Test Procedure	32
11.4 Test Result.....	32
12. RF VOLTAGES IMMUNITY TEST(S2).....	34
12.1 Test setup.....	34
12.2 Test Standard and Limits.....	36
12.3 Test Result	36
13. AMBIENT ELECTROMAGNETIC FIELDS IMMUNITY TEST(S3).....	38
13.1 Block Diagram of Test Setup	38
13.2 Test Standard and Limits.....	39
13.3 Test Result	40
14. PHOTOGRAPHS.....	42
14.1 Photo of Power Line Conducted Emission Measurement.....	42
14.2 Photo of Radiated Emission Measurement.....	42
14.3 Photo of Harmonic Current / Flicker Measurement.....	43
14.4 Photo of Electrostatic Discharge Immunity Measurement	43
14.5 Photo of Electrical Fast Transient /Burst Immunity Measurement	44
14.6 Photo of S2 Measurement	44
14.7 Photo of S3 Measurement.....	45

APPENDIX I (Photos of the E.U.T.) (12 pages)

1. SUMMARY OF TEST RESULTS

The E.U.T. has been tested according to the following specifications:

EMISSION			
Standard	Test Type	Result	Remarks
EN 55032: 2015	Mains Terminal Disturbance Voltage Test	PASS	Uncertainty: 2.7dB
	Antenna Terminal Disturbance Voltage Test	N/A	Meets the requirements.
	Radiated Emission Test	PASS	Uncertainty: 3.4dB
EN 61000-3-2: 2014	Harmonic current emission	PASS	Meets the requirements.
EN 61000-3-3: 2013	Voltage fluctuations & flicker	PASS	Meets the requirements.

IMMUNITY(EN 55020: 2007+A11: 2011)			
Standard	Test Type	Result	Remarks
EN 55020: 2007+A11: 2011	Input immunity (S1)	N/A	Meets the requirements.
	Immunity from conducted voltages (S2a)	PASS	Meets the requirements.
	Immunity from conducted currents (S2b)	N/A	Meets the requirements.
	Immunity from radiated fields (S3)	PASS	Meets the requirements.
	Screening effectiveness (S4)	N/A	Meets the requirements.
EN61000-4-2: 2009	Electrostatic discharge immunity test	PASS	Meets the requirements of Performance Criterion B
EN 61000-4-3: 2006+A2: 2010	Radiated, radio-frequency, electromagnetic field immunity test(S5)	PASS	Meets the requirements of Performance Criterion A
EN 61000-4-4: 2012	Electrical fast transient/ burst immunity test	PASS	Meets the requirements of Performance Criterion B

2. GENERAL INFORMATION

2.1 Details of E.U.T.

E.U.T.	: 5.1 Speaker System
Model No.	: F5060X, F5080X, 5090X, F6000X, F6600X All tests were carried on model F5060X.
Brand Name	: F&D
Rating	: AC 120-240V 50/60Hz 2.5A
Test Voltage	: AC 230V/50Hz, AC 110V/60Hz Only the worst case was recorded in this report
Cable	: AC mains: 1.45m Audio line: 2 to 2*3: 1.53m 1 to 2: 1.53m
Description of model difference	: These models have the same circuit schematic, construction, PCB Layout and critical components. Their difference in model number, appearance and color due to trading purpose.
Remark	: None

2.2 Description of Support Device

FM Signal Generator	:	Manufacturer: LEADER M/N: 3214 S/N: 1100164
iPod	:	Manufacturer: Apple M/N: A1446 S/N: DCYNV5EMF0GQ
DVD Player	:	Manufacturer: Global M/N: THT-5000HDMI S/N: KXZA12161022528
USB Flash Disk	:	Manufacturer: Sony M/N: USB 3.0 8GB
Mobile Phone	:	Manufacturer: Vivo Model: X5SL S/N: 867047023930426

2.3 Block Diagram of Test Setup

Block diagram of connection between the E.U.T. and simulators

(1) FM Mode

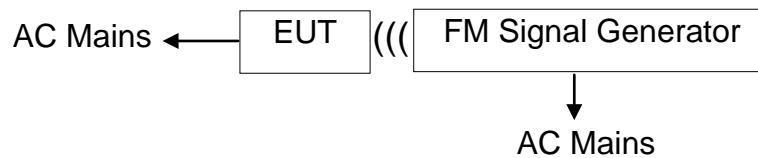

(2) AUX IN



(3) USB Playing



(4) DVD(5.1 CH) Input

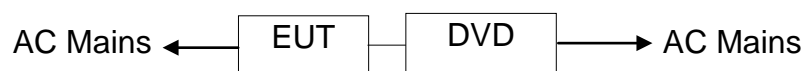

2.4 Test Facility

Site Description

EMC Lab : Listed by CNAS, August 14, 2015
The certificate is valid until August 13, 2018
The Laboratory has been assessed and proved to
be in compliance with CNAS/CL01
The Certificate Registration Number is L5795.

Listed by FCC, July 03, 2014
The Certificate Number is 665078.

Listed by Industry Canada, June 18, 2014
The Certificate Registration Number. Is 46405-9743

Name of Firm : Dongguan Nore Testing Center Co., Ltd.
(Dongguan NTC Co., Ltd.)

Site Location : Building D, Gaosheng Science & Technology Park,
Zhouxi Longxi Road, Nancheng District,
Dongguan City, Guangdong Province, China

2.5 Abnormalities from Standard Conditions

None

3. MEASURING DEVICES AND TEST EQUIPMENT

3.1 For Mains terminals Disturbance voltage test

Item	Equipment	Manufacturer	Model No.	Serial No.	Last Cal.	Cal. Interval
1.	Test Receiver	Rohde & Schwarz	ESCI	101152	Mar. 07, 2016	1 Year
2.	L.I.S.N	Rohde & Schwarz	ENV 216	101317	Mar. 07, 2016	1 Year
3.	L.I.S.N	Schwarzbeck	NNLK8129	8129-212	Mar. 07, 2016	1 Year
4.	RF Switching Unit	Compliance Direction Systems Inc.	RSU-M2	38311	Mar. 07, 2016	1 Year

3.2 For Radiated Emission Measurement

Item	Equipment	Manufacturer	Model No.	Serial No.	Last Cal.	Cal. Interval
1.	Test Receiver	Rohde & Schwarz	ESCI7	100837	Mar. 07, 2016	1 Year
2.	Antenna	Schwarzbeck	VULB9162	9162-010	Apr. 25, 2016	1 Year
3.	Positioning Controller	UC	UC 3000	N/A	N/A	N/A
4.	Color Monitor	SUNSP0	SP-140A	N/A	N/A	N/A
5.	Single Phase Power Line Filter	SAEMC	PF201A-32	110210	N/A	N/A
6.	3 Phase Power Line Filter	SAEMC	PF401A-200	110318	N/A	N/A
7.	DC Power Filter	SAEMC	PF301A-200	110245	N/A	N/A
8.	Cable	Huber+Suhner	CBL3-NN-9M	21490001	Mar. 07, 2016	1 Year
9.	Cable	Huber+Suhner	RG223U	N/A	Mar. 07, 2016	1 Year
10.	Power Amplifier	HP	HP 8447D	1145A00203	Mar. 07, 2016	1 Year

3.3 For Harmonic / Flicker Measurement

Item	Equipment	Manufacturer	Model No.	Serial No.	Last Cal.	Cal. Interval
1.	Power Frequency Test System	California Instruments	CTS	72846	Apr. 25, 2016	1 Year
2.	Software	California Instruments	CTS30	N/A	N/A	N/A

3.4 For Electrostatic Discharge Test

Item	Equipment	Manufacturer	Model No.	Serial No.	Last Cal.	Cal. Interval
1.	ESD Tester	TESEQ	NSG 437	432	Apr. 26, 2016	1 Year

3.5 For RF Electromagnetic Field Immunity Test

Item	Equipment	Manufacturer	Model No.	Serial No.	Last Cal.	Cal. Interval
1.	Signal Generator	Agilent	N5181A	MY50142530	Aug. 31, 2016	1 Year
2.	Antenna	Schwarzbeck	VULB9162	9162-010	Apr. 25, 2016	1 Year
3.	RF Power Meter	ESE	4242	13984	Aug. 31, 2016	1 Year
4.	Power Amplifier	TESEQ	CBA 1G-150	T44029	N/A	N/A
5.	Power Sensor	ESE	51011EMC	35716	Aug. 31, 2016	1 Year

3.6 For Electrical Fast Transient /Burst Immunity Test

Item	Equipment	Manufacturer	Model No.	Serial No.	Last Cal.	Cal. Interval
1.	Burst Tester	EM TEST	UCS 500N	V1104108683	Mar. 07, 2016	1 Year
2.	Coupling Clamp	EM TEST	HFK	0311-94	Mar. 07, 2016	1 Year
3.	Test Soft	EM TEST	lec. control	N/A	N/A	N/A

3.7 For EN55020 Immunity Test

Item	Equipment	Manufacturer	Model No.	Serial No.	Last Cal.	Cal. Interval
1.	Broadcast System Test	Rohde&Schwarz	SFU	101543	May 14, 2016	1 Year
2.	TV Generator PAL	Rohde&Schwarz	SGPF	100200	May 14, 2016	1 Year
3.	Spectrum Analyzer	Rohde&Schwarz	FSL3	101507	May 14, 2016	1 Year
4.	Signal Generator	Rohde&Schwarz	SMB100A	102382	May 14, 2016	1 Year
5.	Signal Generator	Rohde&Schwarz	SMB100A	102383	May 14, 2016	1 Year
6.	Power Meter	Rohde&Schwarz	NRVS	101732	May 14, 2016	1 Year
7.	Audio Analyzer	Rohde&Schwarz	UPV	101346	May 14, 2016	1 Year
8.	Level Meter	Rohde&Schwarz	URV35	100335	May 14, 2016	1 Year
9.	100V Insertion Unit 50Ω	Rohde&Schwarz	URV5-Z4	100207	May 14, 2016	1 Year
10.	RF Probe	Rohde&Schwarz	URV5-Z7	100657	May 14, 2016	1 Year
11.	Absorbing Clamp	Rohde&Schwarz	MDS-21	100352	May 14, 2016	1 Year
12.	Test Software	Rohde&Schwarz	T80-K1	N/A	N/A	N/A

4. MAINS TERMINAL DISTURBANCE VOLTAGE MEASUREMENT

4.1 Block Diagram of Test Setup

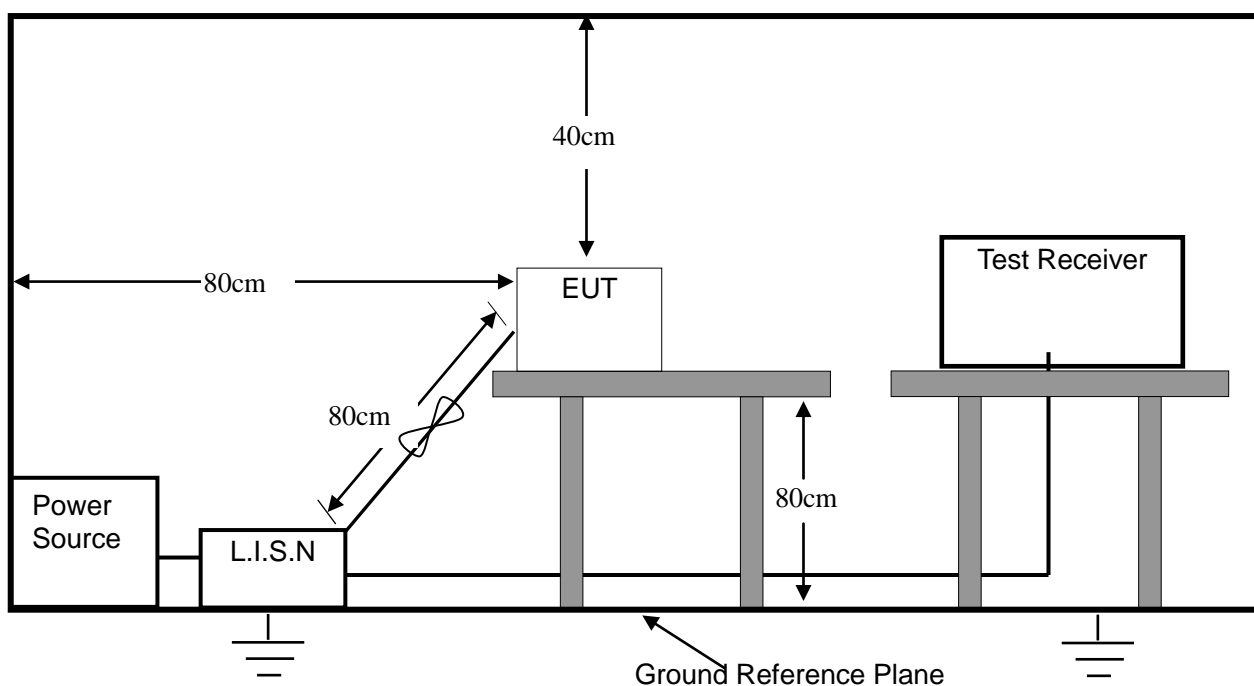

4.2 Limit of Mains Terminal Disturbance voltage measurement

Test Standard: EN 55032

Limits for conducted disturbance at the mains ports.

Frequency range (MHz)	Limits (dB(uV))	
	Quasi-peak	Average
0.15 to 0.5	66 to 56*	56 to 46*
0.5 to 5	56	46
5 to 30	60	50

*Decreasing linearly with the logarithm of the frequency.

- Note:
1. If the limits for the average detector are met when using the quasi-peak detector, then the limits for the measurements with the average detector are considered to be met.
 2. The higher value measured with and without the outer conductor screen of the antenna terminal connected to earth is considered.
 3. Television receivers with teletext facilities should be tested in teletext mode with teletext picture.

4.3 Test Procedure

The E.U.T. is put on the 0.8 m high table and connected to the AC mains through a Artificial Mains Network (AMN). This provided a 50ohm coupling impedance for the tested equipments. Both sides of AC line are checked to find out the maximum conducted emission levels according to the EN55032 regulations during conducted emission test.

The bandwidth of the test receiver (R&S Test Receiver ESCI) is set at 9 KHz.

4.4 Operating Condition of E.U.T.

4.4.1 Setup the E.U.T. and simulators as shown in Section 2.3.

4.4.2 Turn on the power of all equipments.

4.4.3 Let the E.U.T. work in test modes (FM Mode, AUX IN, USB Playing, DVD(5.1 CH) Input) and test it.

4.5 Mains Terminal Disturbance Voltage Test Results

PASS.

Please refer to the following pages of the worst case: AUX IN.

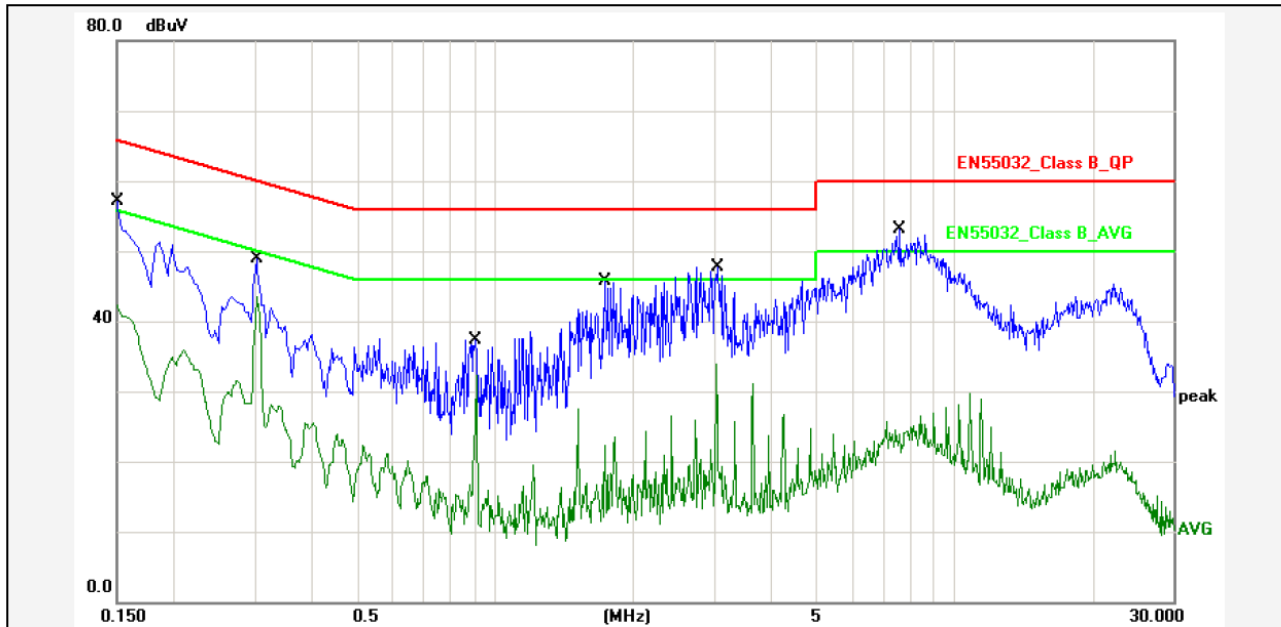

Report No.: F5060X

Test Standard: EN55032_Class B_QP

Test item: Conducted Emission

Phase: L1

Applicant: FENDA

Temp.()/Hum.(%): 22(C) / 52 %

Product: 5.1 Speaker System

Power Rating: AC 230V/50Hz

Model No.: F5060X

Test Engineer: Jerry

Test Mode: AUX IN

Remark:

No.	Frequency (MHz)	Factor (dBuV)	Reading (dBuV)	Level (dBuV)	Limit (dBuV)	Margin (dB)	Detector	P/F	Remark
1	0.1500	10.80	35.40	46.20	65.99	-19.79	QP	P	
2	0.1500	10.80	30.40	41.20	55.99	-14.79	AVG	P	
3	0.3020	10.80	36.20	47.00	60.19	-13.19	QP	P	
4	0.3020	10.80	31.90	42.70	50.19	-7.49	AVG	P	
5	0.9100	10.80	25.80	36.60	56.00	-19.40	QP	P	
6	0.9100	10.80	20.50	31.30	46.00	-14.70	AVG	P	
7	1.7420	10.80	33.50	44.30	56.00	-11.70	QP	P	
8	1.7420	10.80	11.10	21.90	46.00	-24.10	AVG	P	
9	3.0420	10.80	35.50	46.30	56.00	-9.70	QP	P	
10	3.0420	10.80	21.90	32.70	46.00	-13.30	AVG	P	
11	7.6419	10.80	41.90	52.70	60.00	-7.30	QP	P	
12	7.6419	10.80	13.70	24.50	50.00	-25.50	AVG	P	

Note: Level=Reading+Factor.

Margin=Limit-Level.



Dongguan NTC Co., Ltd.
Tel: +86-769-22022444 Fax: +86-769-22022799
Web: [Http://www.ntc-c.com](http://www.ntc-c.com)

Site: Conduction

Test Time: 2016-12-6 15:05:33

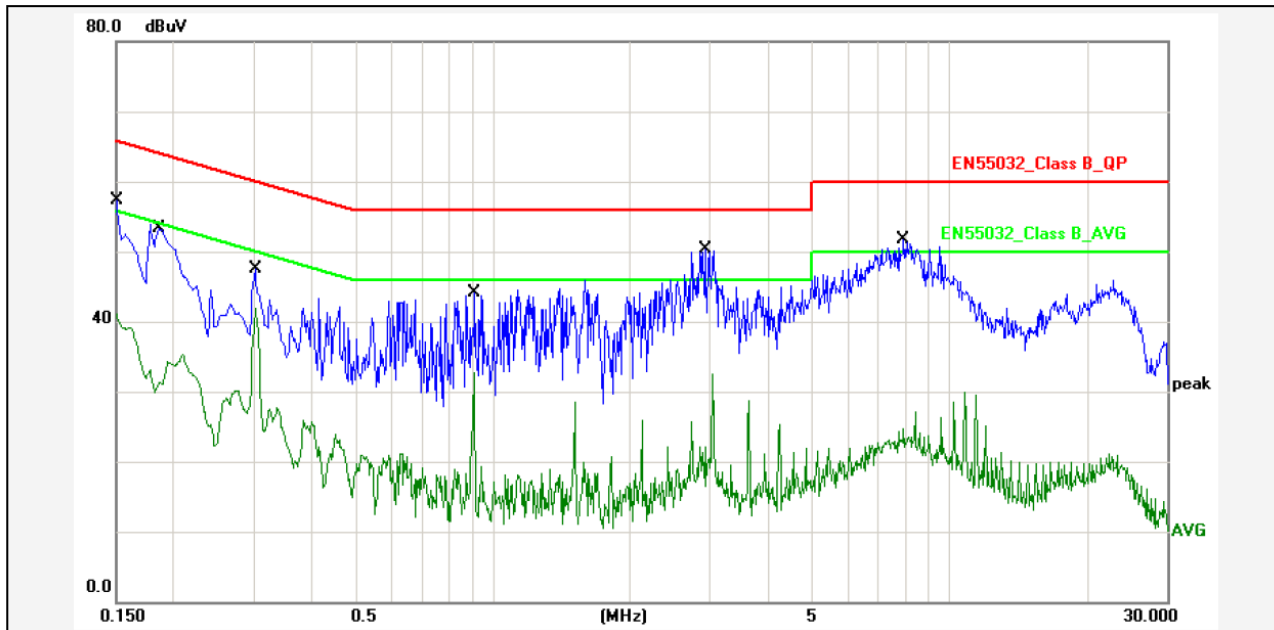

Report No.: F5060X
Test Standard: EN55032_Class B_QP
Test item: Conducted Emission
Applicant: FENDA
Product: 5.1 Speaker System
Model No.: F5060X
Phase: N
Temp.()/Hum.(%): 22(C) / 52 %
Power Rating: AC 230V/50Hz
Test Engineer: Jerry
Test Mode: AUX IN
Remark:

No.	Frequency (MHz)	Factor (dBuV)	Reading (dBuV)	Level (dBuV)	Limit (dBuV)	Margin (dB)	Detector	P/F	Remark
1	0.1500	10.80	45.50	56.30	65.99	-9.69	QP	P	
2	0.1500	10.80	29.50	40.30	55.99	-15.69	AVG	P	
3	0.1859	10.80	41.30	52.10	64.21	-12.11	QP	P	
4	0.1859	10.80	22.50	33.30	54.21	-20.91	AVG	P	
5	0.3019	10.80	36.80	47.60	60.19	-12.59	QP	P	
6	0.3019	10.80	25.00	35.80	50.19	-14.39	AVG	P	
7	0.9140	10.80	32.20	43.00	56.00	-13.00	QP	P	
8	0.9140	10.80	20.70	31.50	46.00	-14.50	AVG	P	
9	2.9260	10.80	38.30	49.10	56.00	-6.90	QP	P	
10	2.9260	10.80	14.00	24.80	46.00	-21.20	AVG	P	
11	7.9618	10.80	39.40	50.20	60.00	-9.80	QP	P	
12	7.9618	10.80	12.80	23.60	50.00	-26.40	AVG	P	

Note: Level=Reading+Factor.
Margin=Limit-Level.

5. RADIATED EMISSION MEASUREMENT

5.1 Block Diagram of Test

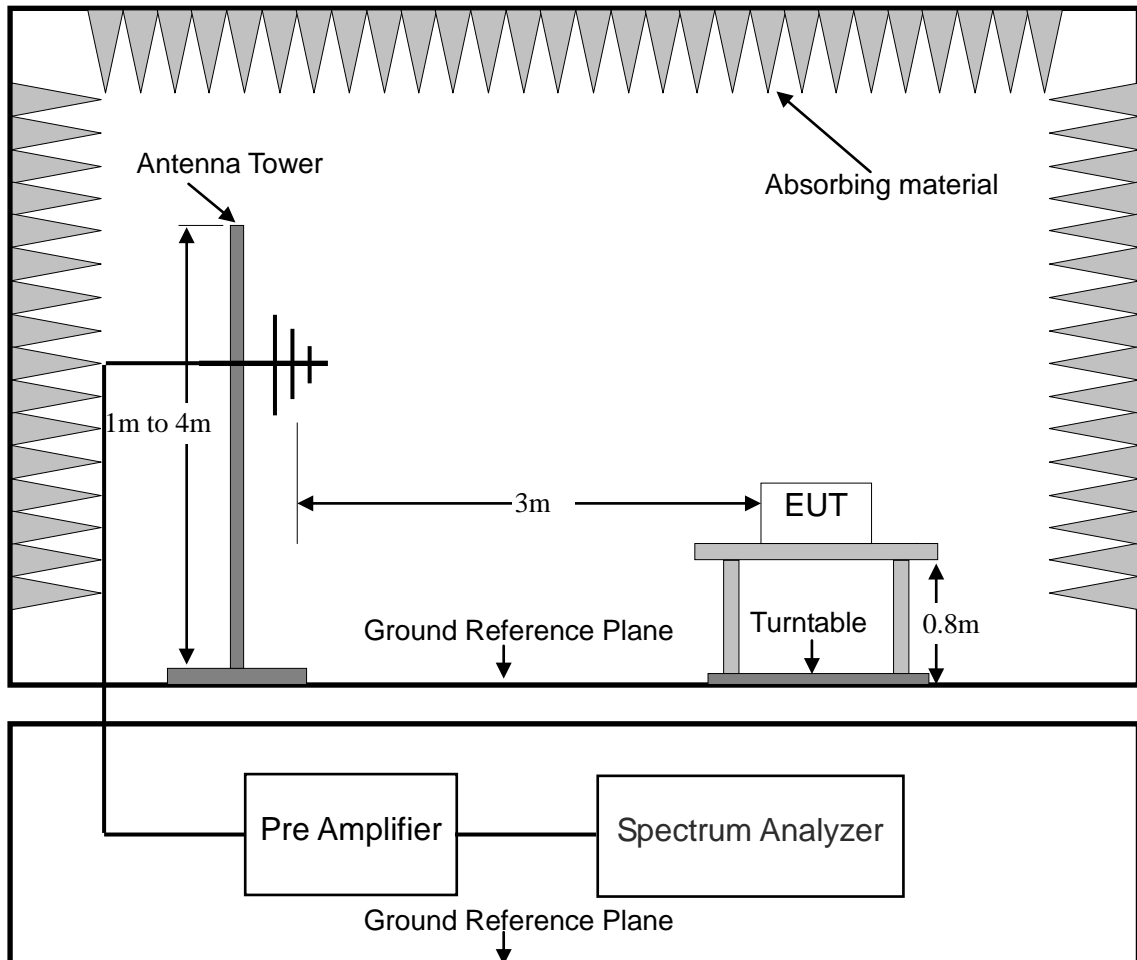

5.2 Limit of Radiated Emission Measurement

Test Standard: EN 55032

Limits for radiated disturbance at a measuring distance of 3m
 Limits below 1GHz

Frequency range MHz	Quasi-peak limits dB(uV/m)
30 to 230	40
230 to 1000	47

Note 1 The lower limit shall apply at the transition frequency.

Note 2 Additional provisions may be required for cases where interference occurs.

5.3 Test Procedure

E.U.T. and its simulators are placed on a turntable, which is 0.8 meter high above ground. The turntable can rotate 360 degrees to determine the position of the maximum emission level. E.U.T. is set 3.0 meters away from the receiving antenna, which is mounted on a antenna tower. The antenna can be moved up and down between 1.0 meter and 4 meters to find out the maximum emission level. Broadband antenna (calibrated bilog antenna) is used as receiving antenna. Both horizontal and vertical polarization of the antenna is set on measurement. In order to find the maximum emission levels, all of the interface cables must be manipulated according to EN 55032 on radiated emission measurement.

The bandwidth of the EMI test is set at 120 KHz.
The frequency range from 30 MHz to 1 GHz is checked.

5.4 Operating Condition of E.U.T.

5.4.1 Setup the E.U.T. and simulators as shown in Section 2.3.

5.4.2 Turn on the power of all equipments.

5.4.3 Let the E.U.T. work in test modes (FM Mode, AUX IN, USB Playing, DVD(5.1 CH) Input) and test it.

5.5 Radiated Emission Measurement Result

PASS.

Please refer to the following pages of the worst case: DVD(5.1 CH) Input.



Dongguan NTC Co., Ltd.
 Tel: +86-769-22022444 Fax: +86-769-22022799
 Web: [Http://www.ntc-c.com](http://www.ntc-c.com)

Site: Radiation

Test Time: 2016-11-30 11:39:42

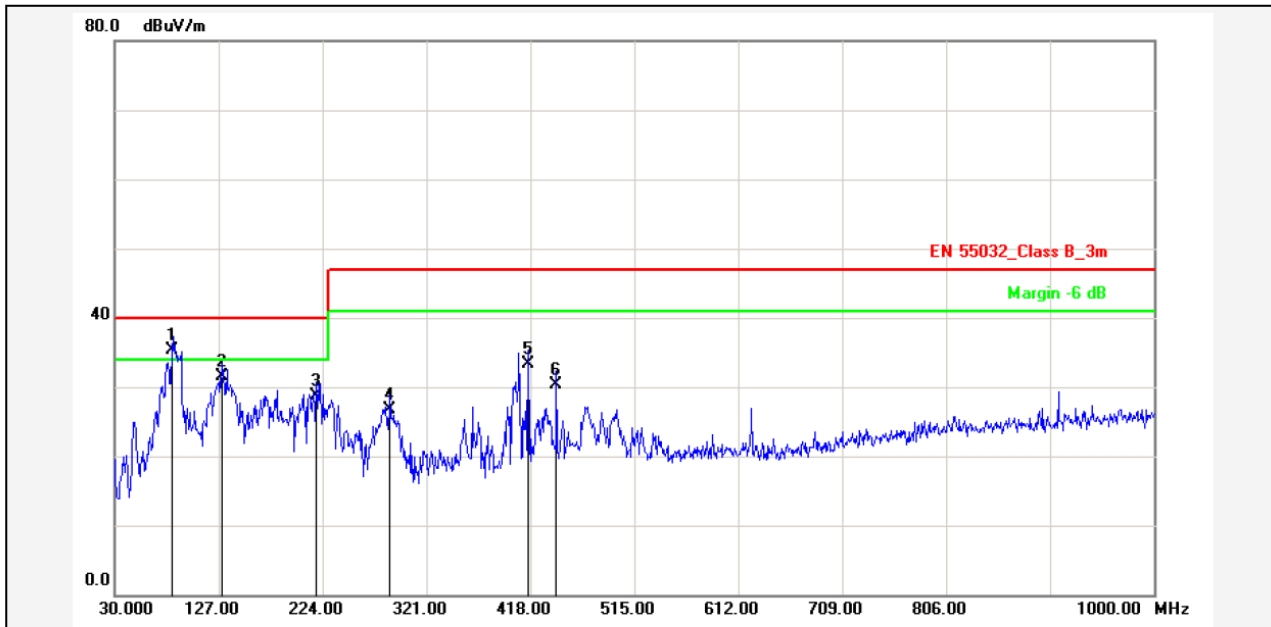

Report No.: F5060X
 Test Standard: EN 55032_Class B_3m
 Test item: Radiation Emission
 Applicant: FENDA
 Product: 5.1 Speaker System
 Model No.: F5060X

Test Distance: 3m
 Ant. Polarization: Horizontal
 Temp.(C)/Hum.(%): 22(C) / 54 %
 Power Rating: AC 230V/50Hz
 Test Engineer: Chilam

Test Mode: DVD(5.1 CH) Input
 Remark:

No.	Frequency (MHz)	Factor (dB/m)	Reading (dBuV)	Level (dBuV/m)	Limit (dBuV/m)	Margin (dB)	Detector	Height (cm)	Azimuth (deg.)	P/F	Remark
1	84.3198	-15.31	50.71	35.40	40.00	-4.60	QP			P	
2	129.9096	-15.15	46.65	31.50	40.00	-8.50	QP			P	
3	218.1800	-13.02	41.72	28.70	40.00	-11.30	QP			P	
4	287.0500	-10.83	37.63	26.80	47.00	-20.20	QP			P	
5	416.0600	-8.73	42.03	33.30	47.00	-13.70	QP			P	
6	442.2500	-8.16	38.46	30.30	47.00	-16.70	QP			P	

Note: Level=Reading+Factor.
 Margin=Limit-Level.



Dongguan NTC Co., Ltd.
Tel: +86-769-22022444 Fax: +86-769-22022799
Web: [Http://www.ntc-c.com](http://www.ntc-c.com)

Site: Radiation

Test Time: 2016-11-30 11:45:17

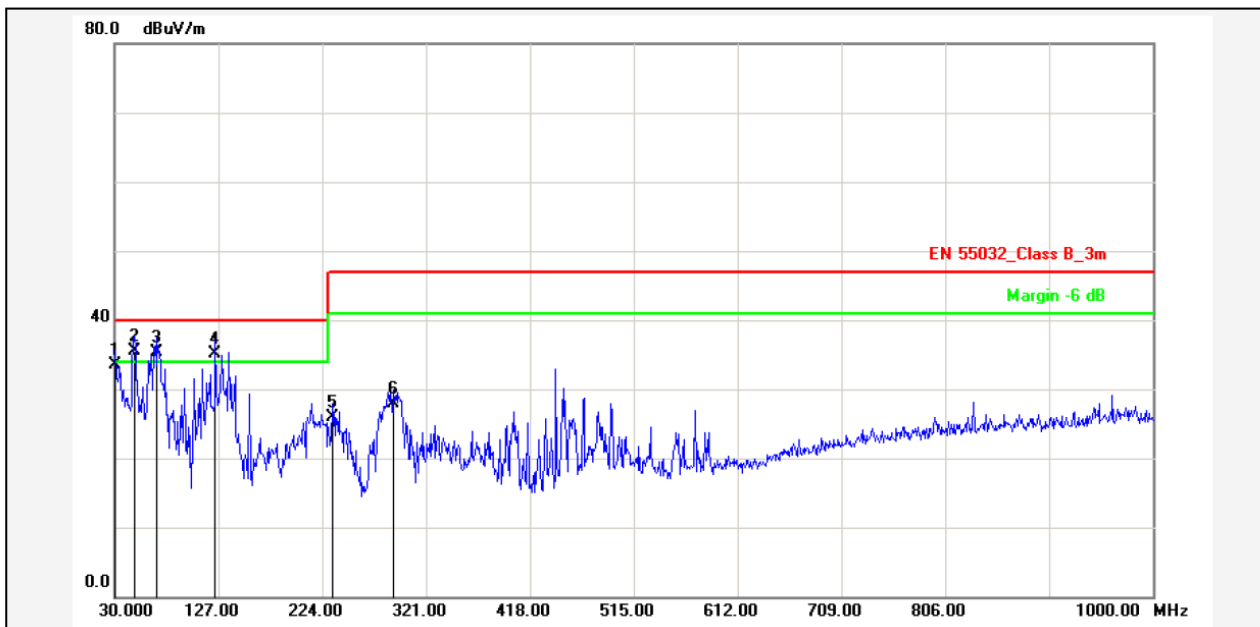

Report No.: F5060X
 Test Standard: EN 55032_Class B_3m
 Test item: Radiation Emission
 Applicant: FENDA
 Product: 5.1 Speaker System
 Model No.: F5060X
 Test Distance: 3m
 Ant. Polarization: Vertical
 Temp.(C)/Hum.(%): 22(C) / 54 %
 Power Rating: AC 230V/50Hz
 Test Engineer: Chilam
 Test Mode: DVD(5.1 CH) Input
 Remark:

No.	Frequency (MHz)	Factor (dB/m)	Reading (dBuV)	Level (dBuV/m)	Limit (dBuV/m)	Margin (dB)	Detector	Height (cm)	Azimuth (deg.)	P/F	Remark
1	30.0000	-15.90	49.50	33.60	40.00	-6.40	QP			P	
2	48.4299	-13.42	49.02	35.60	40.00	-4.40	QP			P	
3	69.7699	-17.31	52.71	35.40	40.00	-4.60	QP			P	
4	124.0900	-17.51	52.61	35.10	40.00	-4.90	QP			P	
5	233.6999	-15.30	41.20	25.90	47.00	-21.10	QP			P	
6	290.9300	-12.73	40.63	27.90	47.00	-19.10	QP			P	

Note: Level=Reading+Factor.
Margin=Limit-Level.

6. HARMONIC CURRENT EMISSION TEST

6.1 Block Diagram of Test Setup

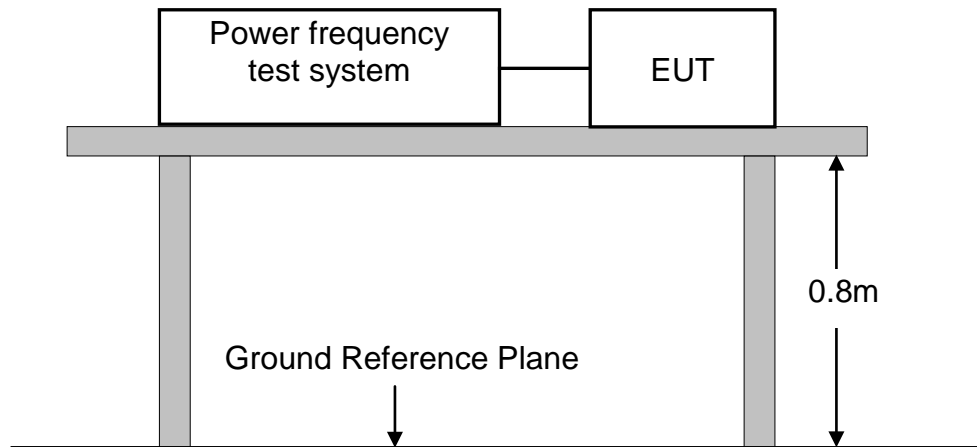

6.2 Limits of Harmonics current measurement

Test Standard: EN 61000-3-2

Limits for Class A equipment	
Harmonics Order n	Max. permissible harmonics current A
Odd harmonics	
3	2.30
5	1.14
7	0.77
9	0.40
11	0.33
13	0.21
15 ≤ n ≤ 39	0.15 × 15/n
Even harmonics	
2	1.08
4	0.43
6	0.30
8 ≤ n ≤ 40	0.23 × 8/n

For the following categories of equipment limits are not specified in this edition of the standard.

Note: Equipment with a rated power of 75W or less, other than lighting equipment.

6.3 Test Procedure

The E.U.T. was put on the top of a wooden table 0.8m above the ground and operated to produce the maximum harmonic components under normal operating conditions for each successive harmonic component in turn.

The E.U.T. is classified as follows:

Class A:

Balanced three-phase equipment, Household appliances excluding equipment as Class D, Tools excluding portable tools, Dimmers for incandescent lamps, audio equipment, equipment not specified in one of the three other classes.

Class B:

Portable tools; Arc welding equipment which is not professional equipment.

Class C:

Lighting equipment.

Class D:

Equipment having a specified power less than or equal to 600W of the following types: Personal computers and personal computer monitors and television receivers.

6.4 Operating Condition of E.U.T.

6.4.1 Setup the E.U.T. and simulators as shown in Section 2.3.

6.4.2 Turn on the power of all equipments.

6.4.3 Let the E.U.T. work in test mode (USB Playing) and test it.

6.5 Test Results

PASS.

According to clause 7 of EN 61000-3-2, equipment with a rated power of 75W or less, no limits apply. It is considered to meet the requirements of the standard.

7. VOLTAGE FLUCTUATIONS & FLICKER TEST

7.1 Block Diagram of Test Setup

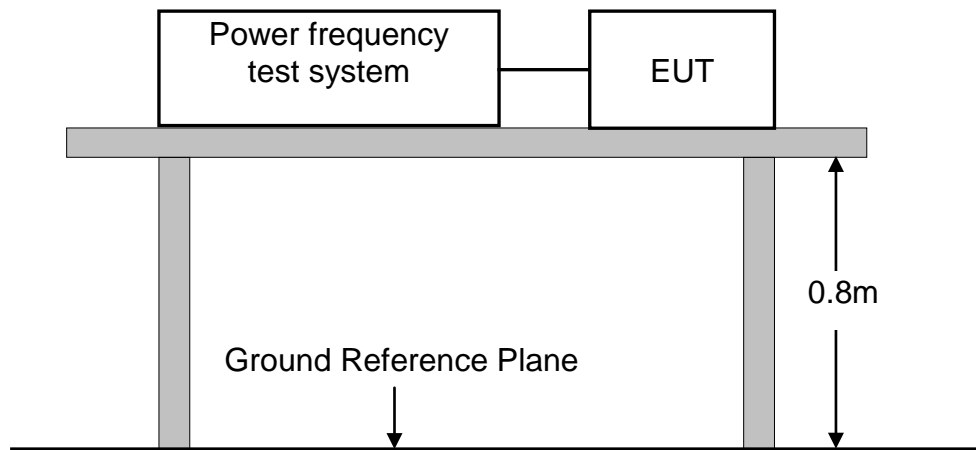

7.2 Limits of Voltage Fluctuations & Flicker Measurement

Test Standard: EN 61000-3-3

Test Item	Limit
P_{st} (Short-term flicker indicator.)	1.0
P_{lt} (Long-term flicker indicator.)	0.65
$T_{d(t)}$ (ms) (Maximum time that $d(t)$ exceeds 3.3%)	500
d_{max} (%) (Maximum relative voltage change.)	4
d_c (%) (Relative steady-state voltage change)	3.3

7.3 Test Procedure

The E.U.T. was put on the top of a wooden table 0.8m above the ground and operated to produce the most unfavorable sequence of voltage changes under normal operating conditions.

7.4 Operating Condition of E.U.T.

7.4.1 Setup the E.U.T. and simulators as shown in Section 2.3.

7.4.2 Turn on the power of all equipments.

7.4.3 Let the E.U.T. work in test mode (USB Playing) and test it.

7.5 Test Results

PASS.

Please refer to the following page.

Flicker Test Summary per EN/IEC61000-3-3 (Run time)

EUT: 5.1 Speaker System
 Test category: All parameters (European limits)
 Test date: 2016-10-1
 Test duration (min): 10
 Comment: USB Playing
 Customer: FENDA
 M/N: F5060X
 Test Result: Pass

Tested by: Ryan
 Test Margin: 100
 End time: 10:31:48
 Data file name: F-000137.cts_data

Status: Test Completed

Pst_i and limit line

European Limits



Plt and limit line

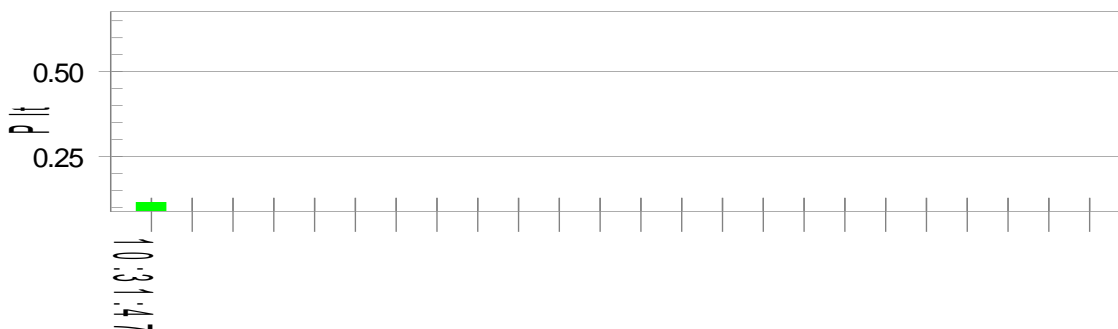

Parameter values recorded during the test:

Vrms at the end of test (Volt):	230.29		
Highest dt (%):	0.00	Test limit (%):	N/A
T-max (mS):	0	Test limit (mS):	500.0
Highest dc (%):	0.00	Test limit (%):	3.30
Highest dmax (%):	0.05	Test limit (%):	4.00
Highest Pst (10 min. period):	0.263	Test limit:	1.000
Highest Plt (2 hr. period):	0.115	Test limit:	0.650

8. PERFORMANCE CRITERIA FOR IMMUNITY

The performance criteria are referred to the test standard:

EN 55020

Performance Criteria A

The equipment shall continue to operate as intended during the test. No change of actual operating state (for example change of channel) is allowed as a result of the application of the test. Multifunction equipment shall for each function meet the relevant requirements. Evaluation is carried out for audio and video functions.

Evaluation of Audio Quality

The criterion of compliance with the requirement is a wanted to unwanted audio signal ratio of ≥ 40 dB at a wanted audio signal level of 50mW, or at another audio signal level specified by the manufacturer. If the S/N ratio is less than 43dB, the performance criterion for audio assessment is the actual S/N ratio minus 3dB. For AM sound receivers the criterion is ≥ 26 dB at 50mW; and is ≥ 26 dB at 500mW for the AM/FM car radios or broadcast receiver cards for computers.

Evaluation of Video Quality

In the evaluation of picture interference the wanted test signal produces a standard picture (in the case of video tape equipment on the screen of the test-tv-set) and the unwanted signal produces a degradation of the picture. The degradation may be in a number of forms, such as a superposed pattern, disturbance of synchronization, geometrical distortion, loss of picture contrast, of colour, etc.

The criterion of compliance with the requirement is just perceptible degradation by observation of the picture. The screen shall be observed under normal viewing conditions (brightness 15 lx to 20 lx), at a viewing distance of six times the height of the screen.

Performance criterion B

The equipment shall continue to operate as intended after the test. No loss of function is allowed after the test when the apparatus is used as intended, but failures which are recovered automatically but which cause temporary delay in processing, are permissible. No change of actual operating state for example change of channel or stored data and settings is allowed as a result of the application of the test. During the test, degradation of performance is allowed.

9. ELECTROSTATIC DISCHARGE IMMUNITY TEST

9.1 Block Diagram of Test Setup

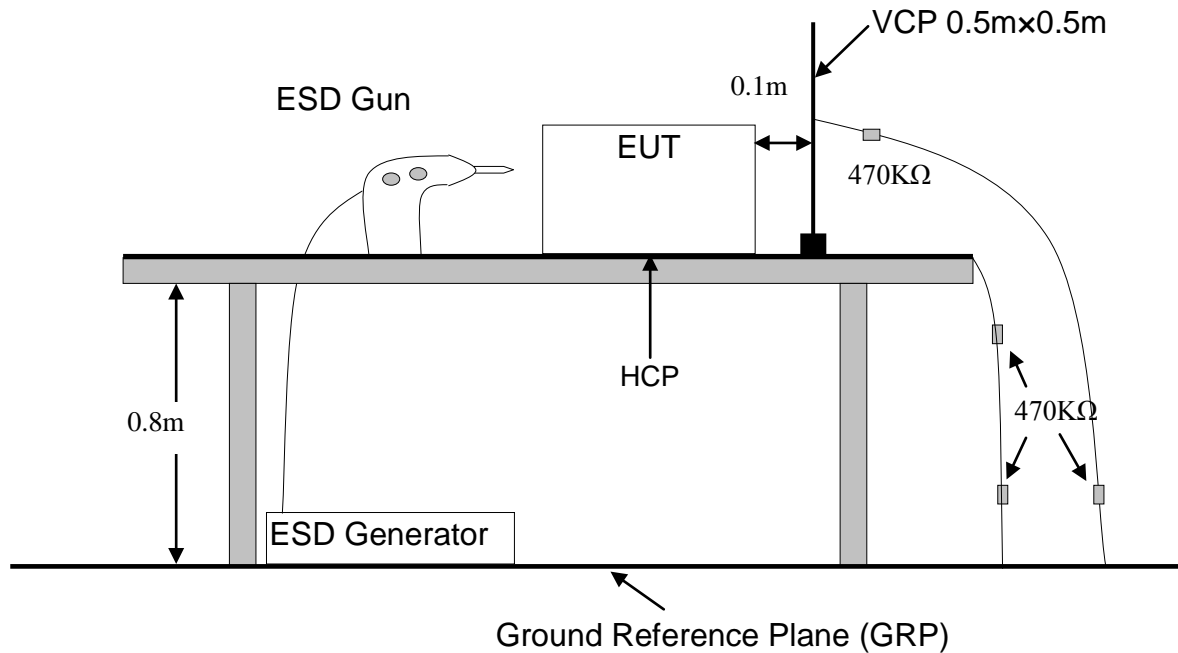

9.2 Test Standard and Severity Levels

9.2.1 Test Standard:

EN 55020

(EN 61000-4-2 Air Discharge: Severity Level: 3, ± 8 KV;
 Contact Discharge: Level: 2, ± 4 KV)

9.2.2 Severity Levels:

Level	Test Voltage Contact Discharge (KV)	Test Voltage Air Discharge (KV)
1.	± 2	± 2
2.	± 4	± 4
3.	± 6	± 8
4.	± 8	± 15
X	Special	Special

9.3 Test Procedure

9.3.1 Air Discharge:

This test is done on a non-conductive surface. The round discharge tip of the discharge electrode shall be approached as fast as possible to touch the E.U.T.. After each discharge, the discharge electrode shall be removed from the E.U.T..

The generator is then re-triggered for a new single discharge and repeated 10 times for each pre-selected test point. This procedure shall be repeated until all the air discharge completed.

9.3.2 Contact Discharge:

All the procedure shall be same as Section 9.3.1. except that the tip of the discharge electrode shall touch the E.U.T..

9.3.3 Indirect discharge for horizontal coupling plane

At least 10 single discharges (in the most sensitive polarity) shall be applied at the front edge of each HCP opposite the center point of each unit(if applicable) of the E.U.T. and 0.1m from the front of the E.U.T.. The long axis of the discharge electrode shall be in the plane of the HCP and perpendicular to its front edge during the discharge.

9.3.4 Indirect discharge for vertical coupling plane

At least 10 single discharges (in the most sensitive polarity) shall be applied to the center of one vertical edge of the coupling plane. The coupling plane, of dimensions 0.5m X 0.5m, is placed parallel to, and positioned at a distance of 0.1m from the E.U.T.. Discharges shall be applied to the coupling plane, with this plane in sufficient different positions that the four faces of the E.U.T. are completely illuminated.

9.4 Test Results

PASS.

Please refer to the following page.

Electrostatic Discharge Test Results

Ambient Condition:	Temp.: 22 °C	R.H.: 49 %	Air Pressure : 101 kPa
Power Supply:	AC 230V 50Hz	Required Performance Criterion : B	
Test Level:	±2, 4 KV Contact Discharge; ±2, 4, 8 KV Air Discharge For each point positive 10 times and negative 10 times		
Tested mode:	FM Mode, AUX IN, USB Playing, DVD(5.1 CH) Input		
Test Point	Kind A-Air Discharge C-Contact Discharge	Result (Performance Criterion)	
Screen	A	A	
Screw	C	A	
USB Port	C	B	
Metal	C	A	
Coaxial Port	C	A	
Indirect Discharge (HCP)	C	A	
Indirect Discharge (VCP)	C	A	
<p>Note: The EUT Power off during the test, but it can be resumed to normal operation by user after test. After consider with client's confirmation that relevant instruction will be mentioned in the manual, so the test result was considered to be passed.</p>			
Test Equipment : ESD Tester (TESEQ, NSG 437)		Test Engineer : Ryan	

10. RF FIELD (KEYED CARRIER) STRENGTH SUSCEPTIBILITY

TEST (S5)

10.1 Block Diagram of Test Setup

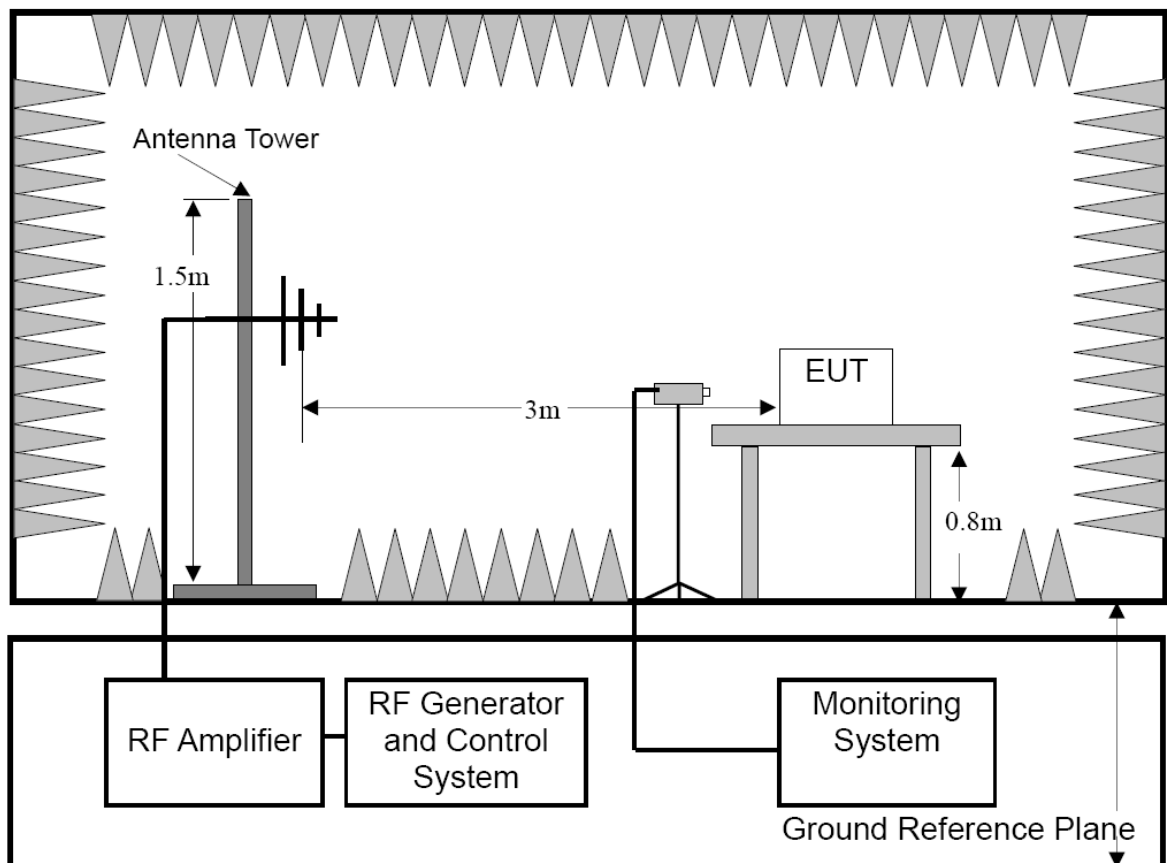

10.2 Test Standard and Severity Levels

10.2.1 Test Standard

EN 55020
 (EN 61000-4-3, Severity Level: 2, 3V / m)

10.2.2 Severity Levels

Level	Field Strength V/m
1.	1
2.	3
3.	10
X	Special

10.3 Test Procedure

The E.U.T. and its simulators are placed on a turn table which is 0.8 meter above ground. E.U.T. is set 3 meter away from the transmitting antenna which is mounted on an antenna tower. Both horizontal and vertical polarization of the antenna are set on test. Each of the four sides of E.U.T. must be faced this transmitting antenna and measured individually.

All the scanning conditions are as follows :

Condition of Test	Remarks
1. Fielded Strength	3 V/m (Severity Level 2)
2. Radiated Signal	Modulated
3. Scanning Frequency	895 - 905 MHz
4. Dwell time of radiated	0.0015 decade/s
5. Waiting Time	1 Sec.

10.4 Test Results

PASS.

Please refer to the following pages of the worst case: AUX IN.

11. ELECTRICAL FAST TRANSIENT/BURST IMMUNITY TEST

11.1 Block Diagram of Test Setup

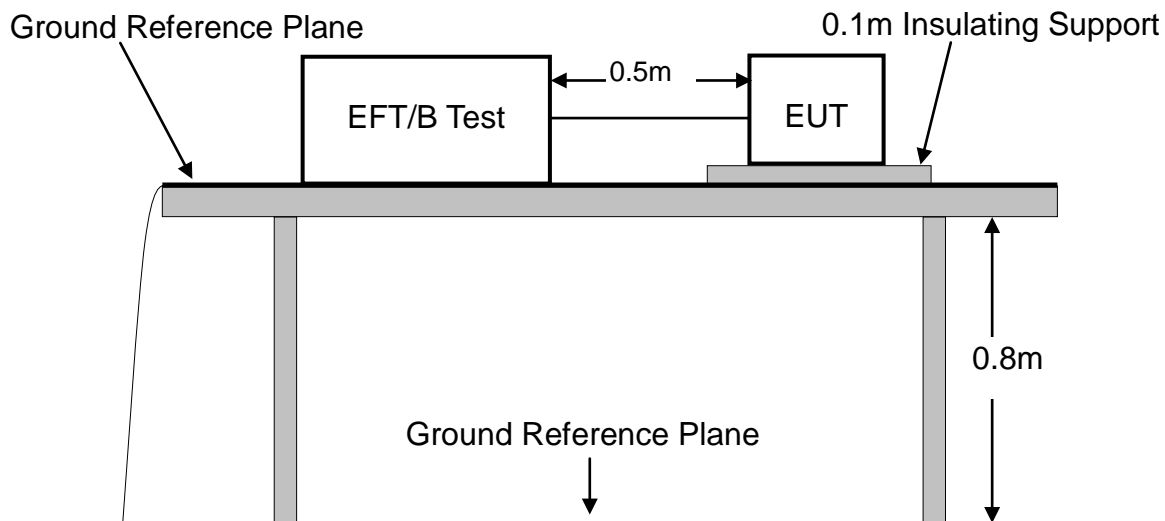

11.2 Test Standard and Severity Levels

11.2.1 Test Standard

EN 55020

(EN 61000-4-4, Severity Level, Level 2: 1KV)

11.2.2 Severity level

Open circuit output test voltage and repetition rate of the impulses				
Level	On power port, PE		On I/O (Input/Output) Signal data and control ports	
	Voltage peak KV	Repetition rate KHz	Voltage peak KV	Repetition rate KHz
1.	0.5 KV	5 or 100	0.25 KV	5 or 100
2.	1 KV	5 or 100	0.5 KV	5 or 100
3.	2 KV	5 or 100	1 KV	5 or 100
4.	4 KV	5 or 100	2 KV	5 or 100
X	Special	Special	Special	Special

Note 1 Use of 5 KHz repetition rates is traditional; however, 100 KHz is closer to reality. Product committees should determine which frequencies are relevant for specific products or product types.

Note 2 With some products, there may be no clear distinction, between power ports and I/O ports, in which case it is up to product committees to make this determination for test purposes.

Note 3 "X" is an open level. The level has to be specified in the dedicated equipment specification.

11.3 Test Procedure

The E.U.T. is put on the table which is 0.8 meter high above the ground. This reference ground plane shall project beyond the E.U.T. by at least 0.1m on all sides and the minimum distance between E.U.T. and all other conductive structure, except the ground plane beneath the E.U.T., shall be more than 0.5m.

11.3.1 For input and output AC power ports:

The E.U.T. is connected to the power mains by using a coupling device which couples the EFT interference signal to AC power lines. Both polarities of the test voltage should be applied during compliance test and the duration of the test is 2 minutes.

11.3.2 For signal lines ports:

It's unnecessary to test.

11.3.3 For DC ports:

It's unnecessary to test.

11.4 Test Result

PASS.

Please refer to the following pages.

Electrical Fast Transient/Burst Test Results

Ambient Condition:	Temp.: 22 °C	R.H.: 49 %	Air Pressure: 101 kPa
Power Supply:	AC 230V 50Hz	Required Performance Criterion: B	
Test Level:	Repetition Frequency: 5kHz; Duration: 15ms; Period: 300ms		
Test mode:	FM Mode, AUX IN, USB Playing, DVD(5.1 CH) Input		
Line :	<input checked="" type="checkbox"/> AC Mains	<input type="checkbox"/> Signal line	<input type="checkbox"/> DC line
Coupling :	<input checked="" type="checkbox"/> Direct	<input type="checkbox"/> Capacitive	
Line	Test Voltage	Result (Performance Criterion)	
L	±1KV	A	
N	±1KV	A	
PE			
L、N	±1KV	A	
L、PE			
N、PE			
L、N、PE			
Signal line			
DC line			
Note:			
Test Equipment : Burst Tester(EM TEST, UCS500N)		Test Engineer : Ryan	

12.2 Test Standard and Limits

12.2.1 Test Standard EN 55020

12.2.2 Limits

Table 1 Limits of immunity of RF voltages of mains, loudspeaker and headphone terminals

Frequency MHz	Level dB(μ V)(e.m.f.)
0.15 to 30	130
30 to 100	120
100 to 150	120-110 ^a
^a Decreasing linearly with the logarithm of frequency	

Table 2 Limits of immunity to RF voltages of audio input and output terminals (except loudspeaker and headphone terminals)(S2)

Frequency MHz	Level dB(μ V)(e.m.f.)
0.15 to 1.6	80-90 ^a
1.6 to 20	90-120 ^a
20 to 100	120
100 to 150	120-110 ^b
^a Increasing linearly with the logarithm of frequency	
^b Decreasing linearly with the logarithm of frequency	

12.3 Test Result

PASS.

Please refer to the following page of the worst case.

Test: Immunity Conducted Voltages S2a <F5060X >

Test Mode:	Combi Device -	Monitor:	Audio Out
Operating Mode:	AUX	S/N:	69.2 dB
Frequency:	-	AF Level:	394.9 mV

Interf. Signal: AUX, 301116-00543-001, 11/31/2016, 4:58:25PM

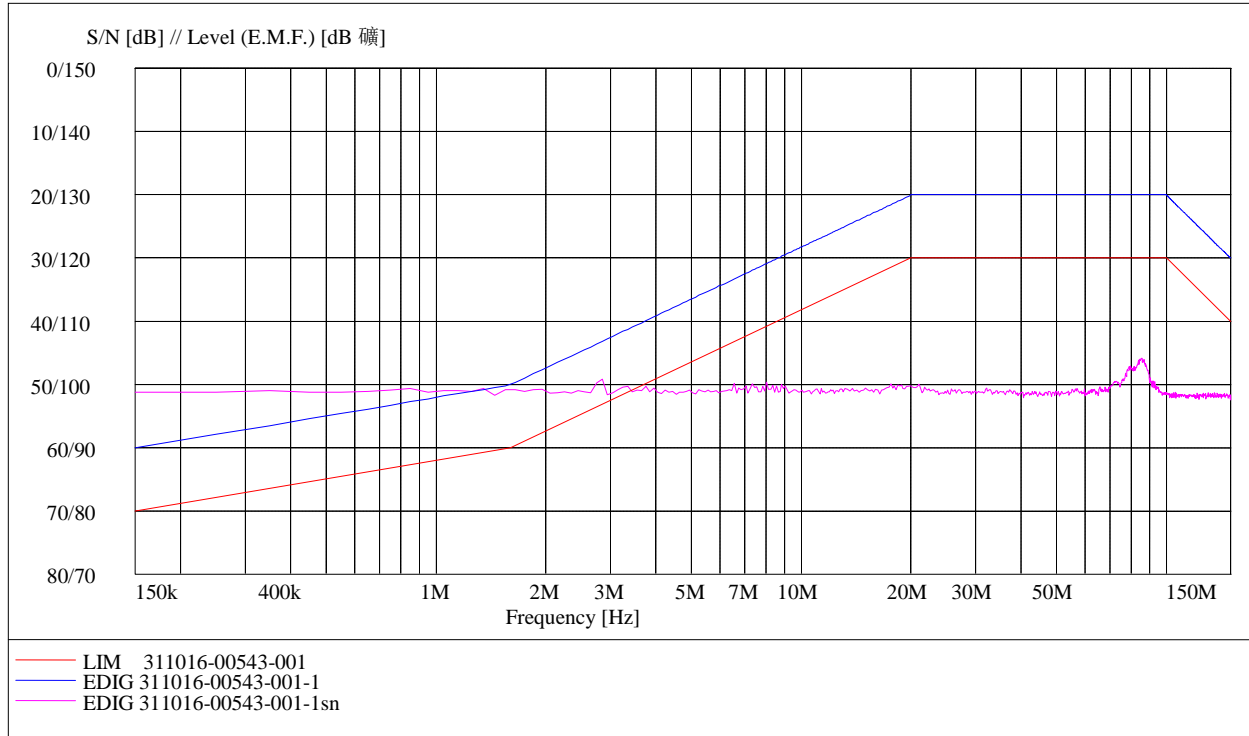

13. AMBIENT ELECTROMAGNETIC FIELDS IMMUNITY TEST(S3)

13.1 Block Diagram of Test Setup

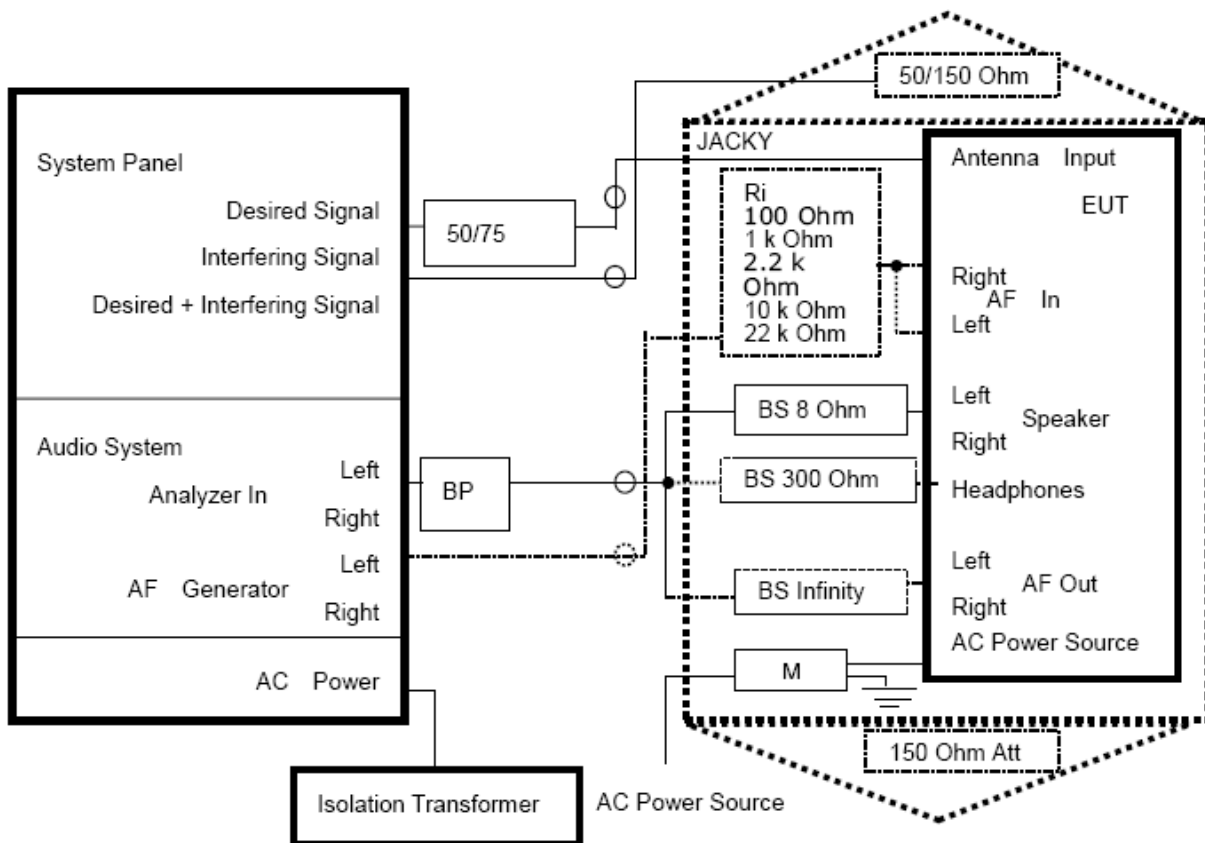

13.2 Test Standard and Limits

13.2.1 Test Standard EN 55020

13.2.2 Limits

Limits of immunity to ambient electromagnetic fields of Television reception functions of sound receivers

Frequency MHz	Level dB(μ V/m)
0,15 to 47 Except frequency bands: $(f_c - 1,5)$ to $(f_c + 1,5)$ $(f_s - 0,5)$ to $(f_s + 0,5)$ $(f_i - 2)$ to $(f_v + 2)$ ^a $(f_v - 2)$ to $(f_i + 2)$ ^b	125 101 101 101 101
For non-European countries and Russia 47 to 150 ^c Except the tuned channel $\pm 0,5$	109 ^d
For European countries 47 to 87 87 to 108 108 to 144 144 to 150 Except the tuned channel $\pm 0,5$	109 125 109 125
NOTE f_i is the sound intermediate frequency f_v is the vision intermediate frequency f_s is the intercarrier sound frequency f_c is the colour subcarrier frequency	
^a For systems B, D, G, K, I, L, M. ^b Only for system L'. ^c The frequency 47 MHz can be varied on a national basis depending on the use of this frequency range. ^d For television receivers with reception function in this frequency range. For television receivers without reception function in this frequency range a level of 125 dB(μ V/m) shall apply.	

13.3 Test Result

PASS.

Please refer to the following pages of the worst case.

Test: Immunity Radiated Fields S3 <F5060X>

Test Mode:	Combi Device -	Monitor:	Audio Out
Operating Mode:	AUX	S/N:	72.0 dB
Frequency:	-	AF Level:	440.7 mV

Interf. Signal: Scan, 301116-00543-001, 11/31/2016, 5:47:28PM K2 = 1.6 dB

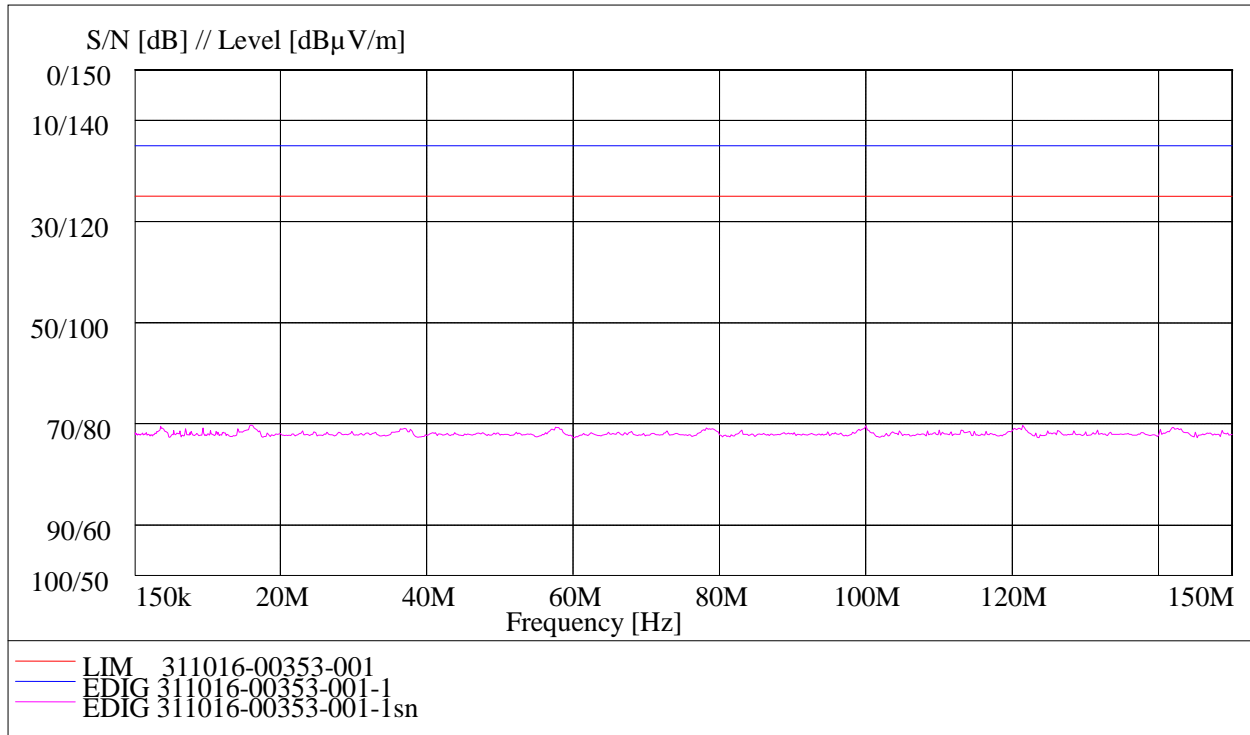

14. PHOTOGRAPHS

14.1 Photo of Power Line Conducted Emission Measurement



14.2 Photo of Radiated Emission Measurement



14.3 Photo of Harmonic Current / Flicker Measurement



14.4 Photo of Electrostatic Discharge Immunity Measurement



14.5 Photo of Electrical Fast Transient /Burst Immunity Measurement



14.6 Photo of S2 Measurement



14.7 Photo of S3 Measurement

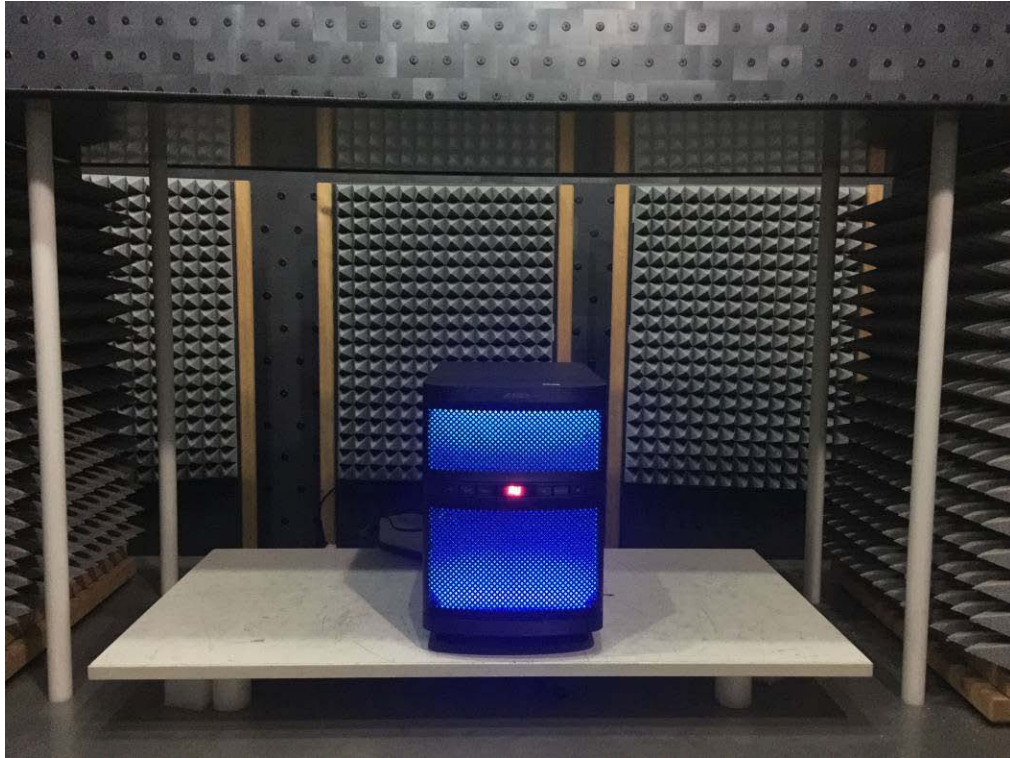

APPENDIX I (PHOTOS OF E.U.T.)

Figure 1
General Appearance of the E.U.T.



Figure 2
General Appearance of the E.U.T.



Figure 3
General Appearance of the E.U.T.



Figure 4
General Appearance of the E.U.T.



Figure 5
General Appearance of the E.U.T.



Figure 6
General Appearance of the E.U.T.



Figure 7
General Appearance of the E.U.T.



Figure 8
General Appearance of the E.U.T.



Figure 9
General Appearance of the E.U.T.



Figure 10
General Appearance of the E.U.T.



Figure 11
General Appearance of the E.U.T.

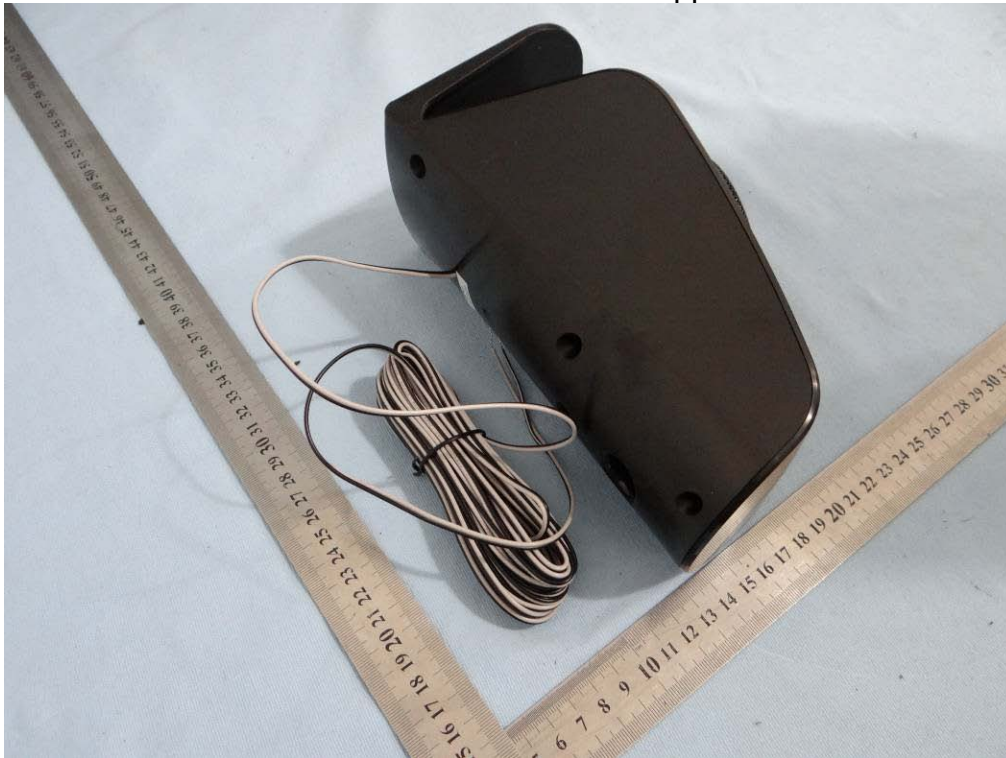

Figure 12
General Appearance of the E.U.T.



Figure 13
General Appearance of the E.U.T.

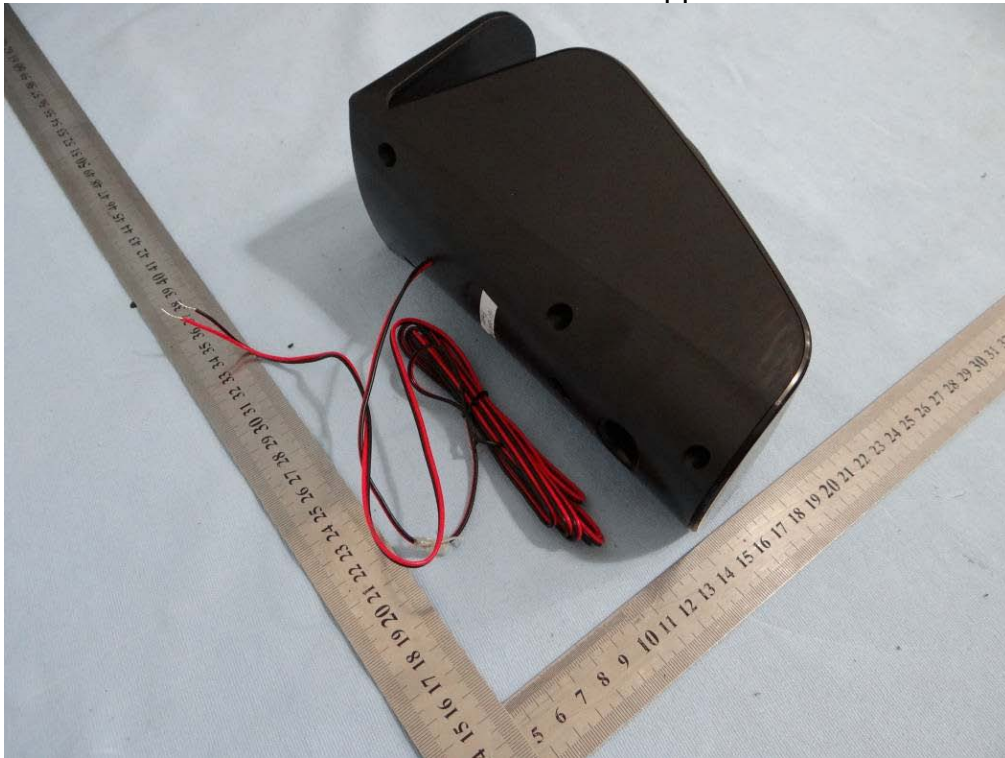

Figure 14
General Appearance of the Remote Control



Figure 15
General Internal of the E.U.T.

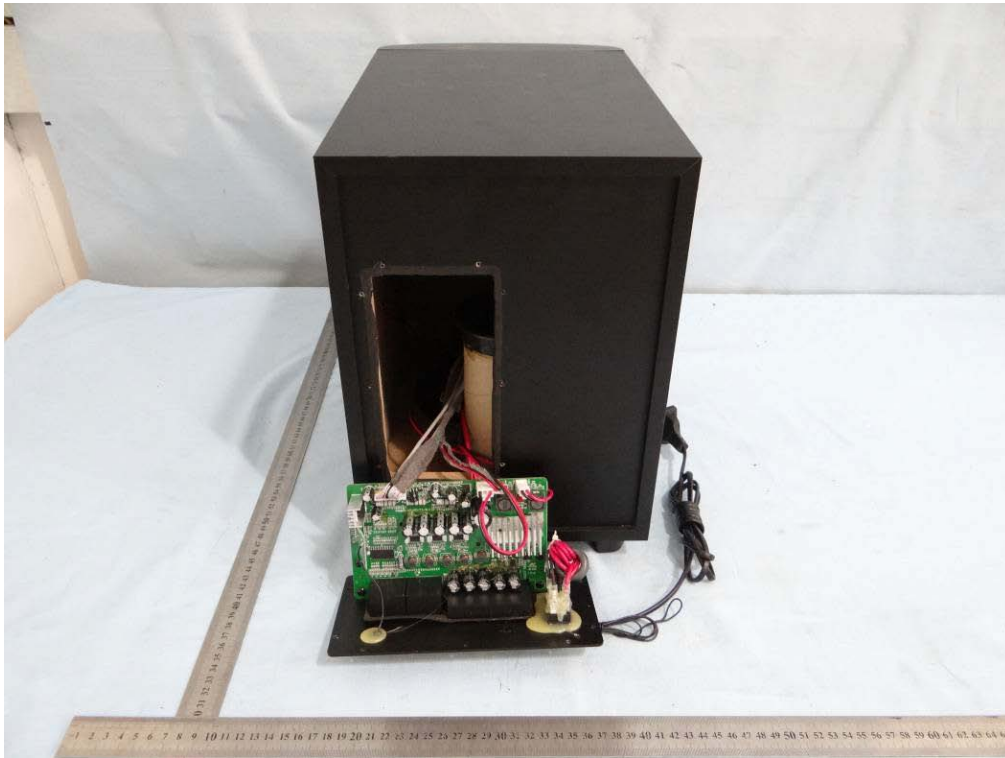

Figure 16
General Internal of the E.U.T.

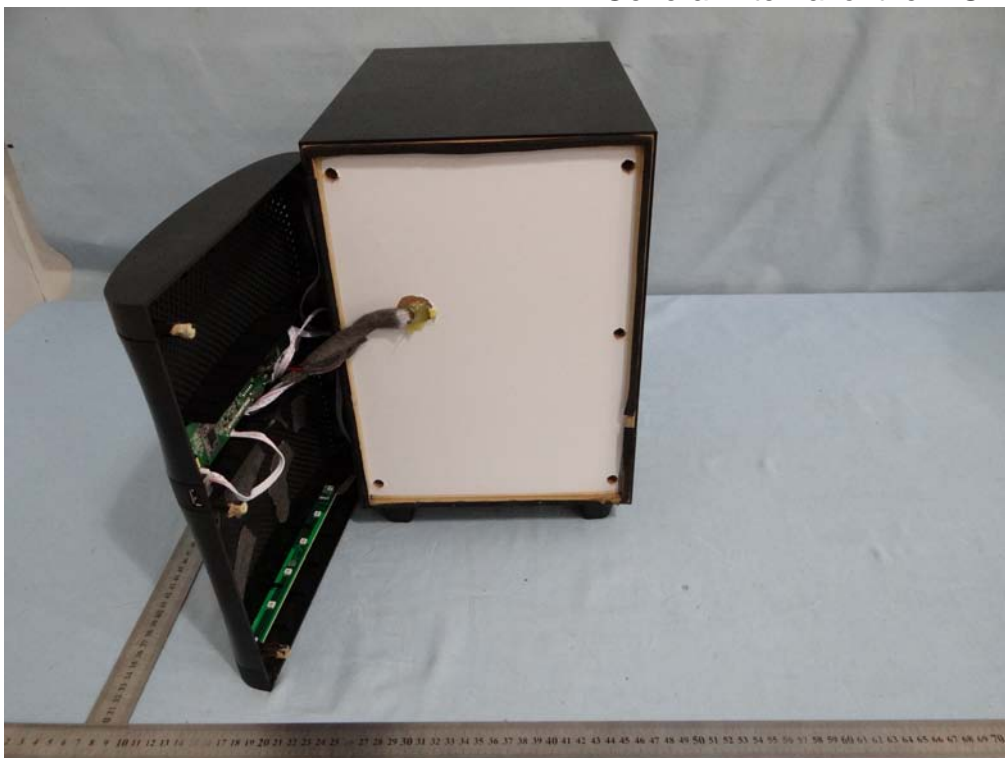

Figure 17
General Appearance of the PCB

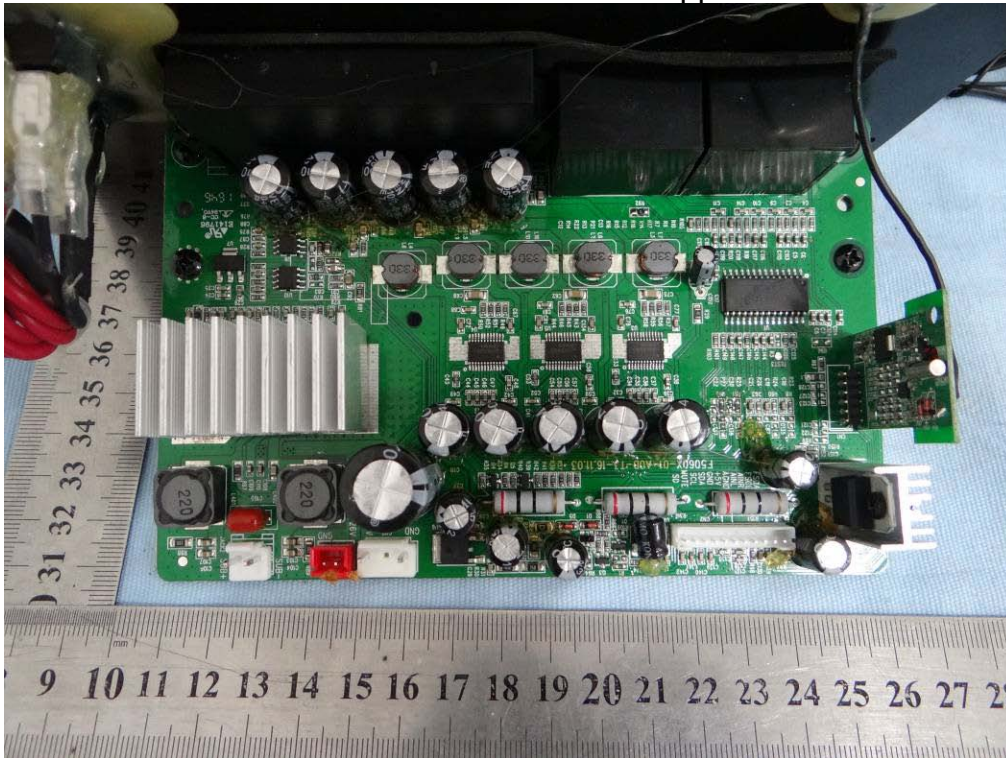

Figure 18
General Appearance of the PCB

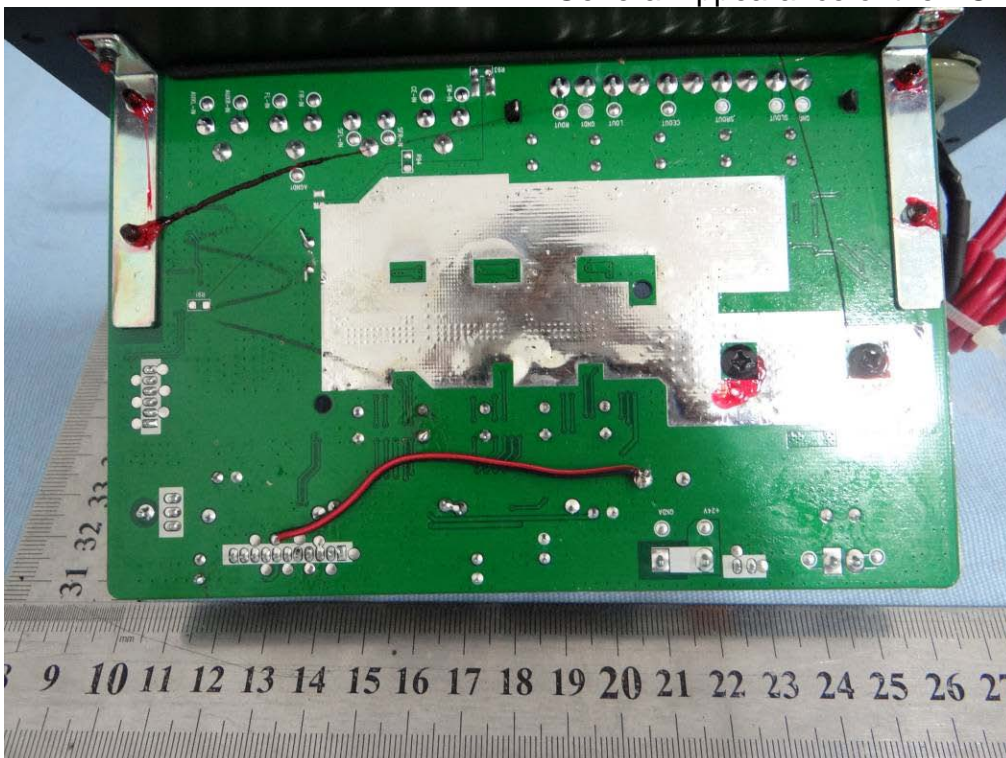

Figure 19
General Appearance of the PCB

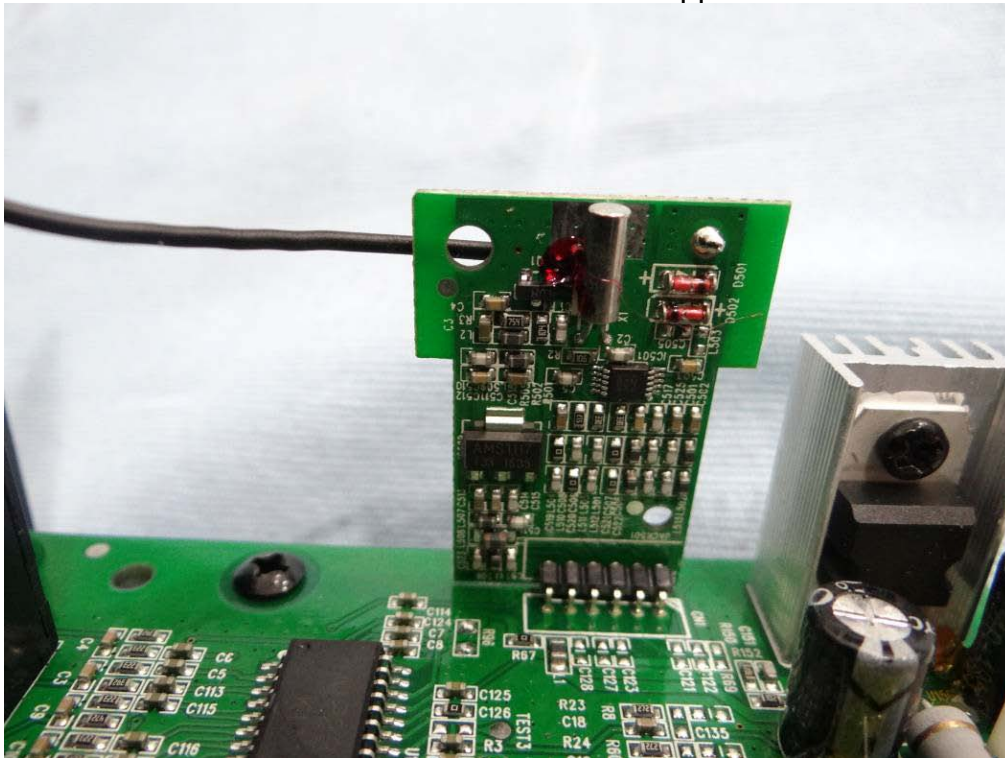

Figure 20
General Appearance of the PCB

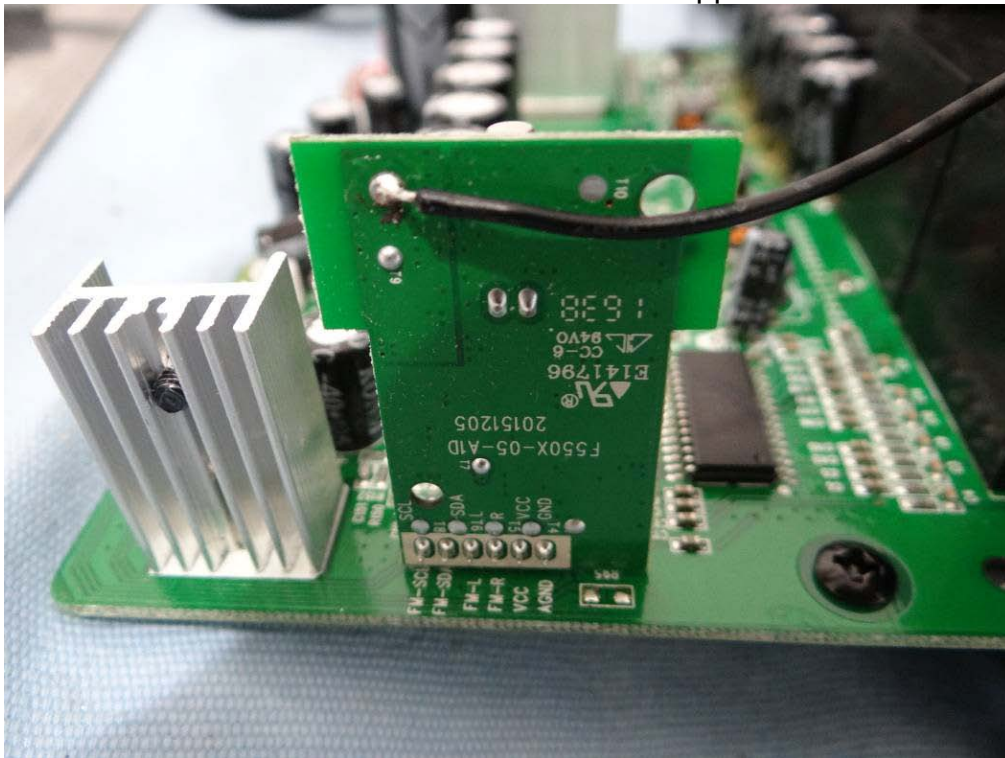

Figure 21
General Appearance of the PCB

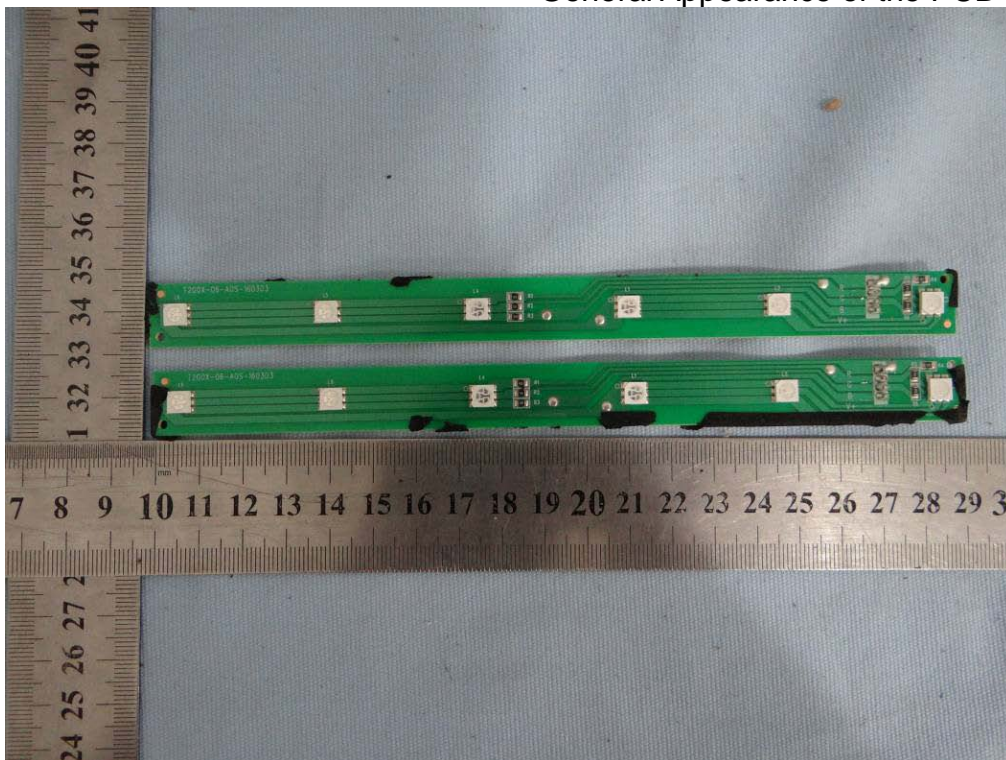

Figure 22
General Appearance of the PCB

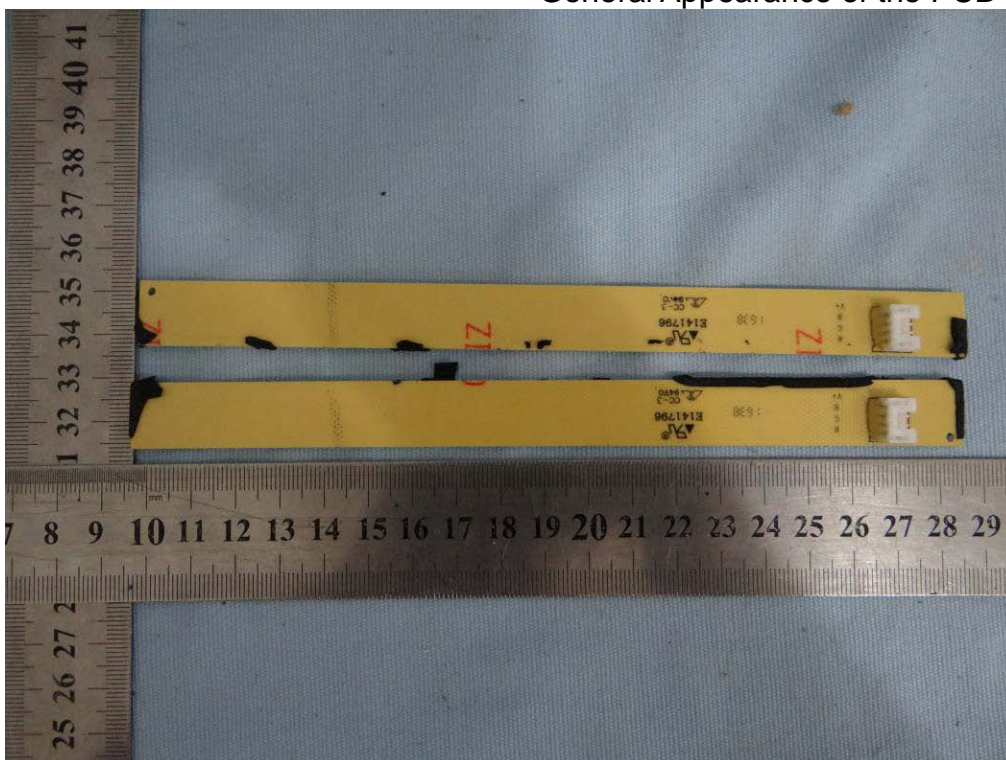

Figure 23
General Appearance of the PCB

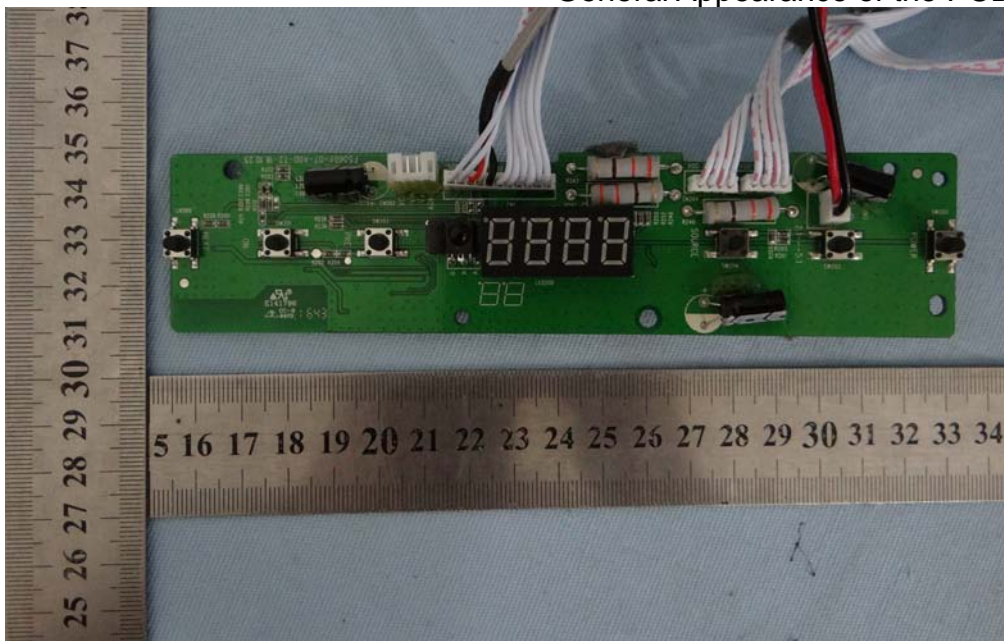
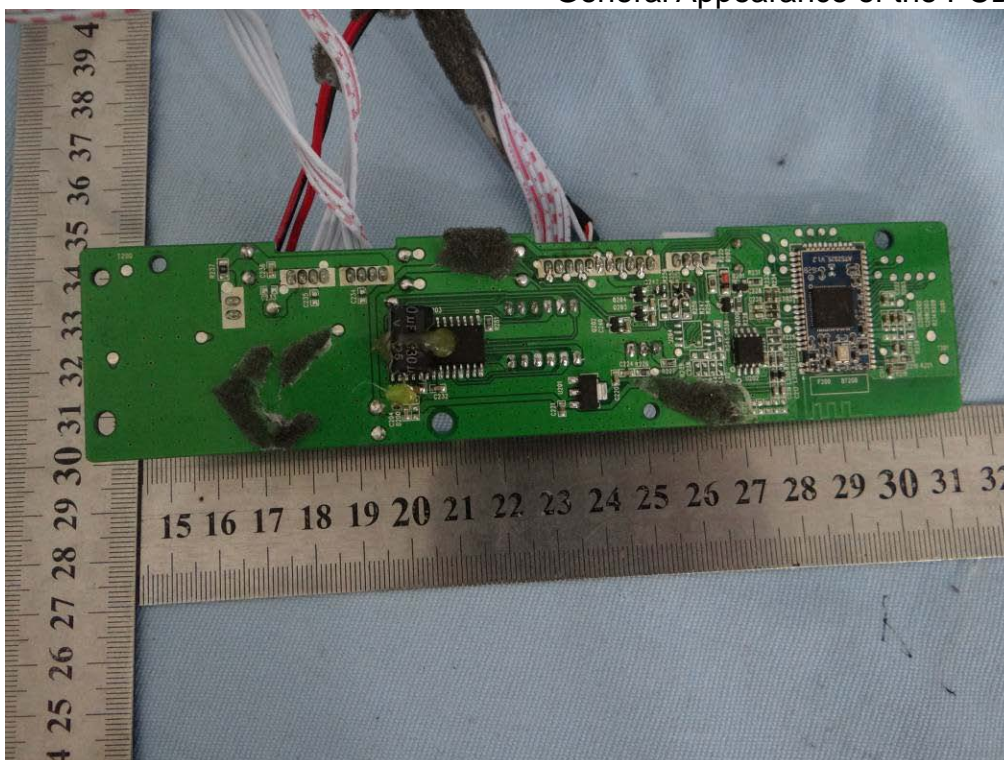

Figure 24
General Appearance of the PCB



---End---