

EMC TEST REPORT

The device described below is tested by Dongguan Nore Testing Center Co., Ltd. to determine the maximum emission levels emanating from the device, the severe levels which the device can endure and E.U.T.'s performance criterion. The test results, data evaluation, test procedures, and equipment of configurations shown in this report were made in accordance with the R&TTE directive 1999/5/EC.

Applicant : SHENZHEN FENDA TECHNOLOGY CO., LTD.
Address : Fenda Hi-Tech Park, Zhoushi Road, Shiyan Town, Baoan District, Shenzhen City, Guangdong, China
Manufacturer/Factory : SHENZHEN FENDA TECHNOLOGY CO., LTD.
Address : Fenda Hi-Tech Park, Zhoushi Road, Shiyan Town, Baoan District, Shenzhen City, Guangdong, China
E.U.T. : 5.1 Speaker System
Brand Name : F&D
Model No. : F5060X, F5080X, 5090X, F6000X, F6600X
(For model difference refer to section 2.1)
Measurement Standard : ETSI EN 301 489-1 v 1.9.2: 2011
ETSI EN 301 489-17 v 2.2.1: 2012
Date of Receiver : November 28, 2016
Date of Test : November 29, 2016 to December 19, 2016
Date of Report : December 19, 2016

This Test Report is Issued Under the Authority of :

Prepared by

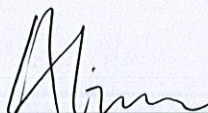
Alina Guo / Engineer

Approved & Authorized Signer



Iori Fan / Authorized Signatory

This test report is for the customer shown above and their specific product only. This report applies to above tested sample only and shall not be reproduced in part without written approval of Dongguan Nore Testing Center Co., Ltd.

TABLE OF CONTENTS

1. GENERAL INFORMATION	4
PRODUCT DESCRIPTION FOR EQUIPMENT UNDER TEST.....	4
2. SUMMARY OF TEST RESULTS	5
3. TEST METHODOLOGY	6
4. MEASURING INSTRUMENT CALIBRATION	6
5. TEST FACILITY	6
6. SUPPORT EQUIPMENT	6
7. PERFORMANCE CRITERIA	7
8. ETSI EN 301 489-1/-17 REQUIREMENTS	8
8.1 RADIATED EMISSION LIMIT	8
8.2 AC POWER CONDUCTED EMISSION.....	14
8.3 AC MAINS HARMONIC CURRENT EMISSION	17
8.4 AC MAINS VOLTAGE FLUCTUATION AND FLICKER.....	18
8.5 ELECTROSTATIC DISCHARGE.....	20
8.6 RF ELECTROMAGNETIC FIELD.....	22
8.7 AC MAINS FAST TRANSIENTS COMMON MODE	24
8.8 AC MAINS SURGE	26
8.9 RADIO FREQUENCY COMMON MODE	28
8.10 VOLTAGE DIPS AND INTERRUPTION	30
8.11 TEST EQUIPMENT LIST.....	32
FOR MAINS TERMINALS DISTURBANCE VOLTAGE TEST.....	32
FOR RADIATED EMISSION MEASUREMENT	32
FOR HARMONIC / FLICKER MEASUREMENT	32
FOR ELECTROSTATIC DISCHARGE TEST	32
FOR RF ELECTROMAGNETIC FIELD IMMUNITY TEST.....	33
FOR ELECTRICAL FAST TRANSIENT /BURST IMMUNITY TEST.....	33
FOR SURGE IMMUNITY TEST.....	33
FOR INJECTED CURRENTS IMMUNITY MEASUREMENT	34
FOR VOLTAGE DIPS AND INTERRUPTIONS MEASUREMENT.....	34



Revision History of This Test Report

Report Number	Description	Issued Date
NTC1611343E	Initial Issue	2016-12-19

1. GENERAL INFORMATION

PRODUCT DESCRIPTION FOR EQUIPMENT UNDER TEST

- Model Name : F5060X, F5080X, 5090X, F6000X, F6600X
 All tests were carried on model F5060X.
- Model difference : These models have the same circuit schematic, construction, PCB Layout and critical components. Their difference in model number, appearance and color due to trading purpose.
- Power Supply : AC 120-240V 50/60Hz 2.5A
- Test Voltage : AC 230V 50Hz
- Operating Temperature Range : 0°C to 35°C (Declaration by manufacturer)
- Adaptive/Non-Adaptive Equipment : Adaptive equipment

Technical Specification:

For BT function
 BT Version: 4.2+EDR and backward compatible BLE.
 We prepare version BLE(V4.0) and 4.2+EDR for RF test..

Item	BT4.2+EDR	BLE(V4.0)
Frequency	2402-2480MHz	2402-2480MHz
Modulation	GFSK, $\pi/4$ -DQPSK, 8DPSK	GFSK
Number of Channel	79	40
Channel space	1MHz	2MHz
Antenna Type	PCB antenna	PCB antenna
Antenna Gain	0.5 dBi (declared by manufacturer)	0.5 dBi (declared by manufacturer)

2. SUMMARY OF TEST RESULTS

The E.U.T. has been tested according to the following specifications:

ETSI EN 301 489-1 v 1.9.2: 2011/ ETSI EN 301 489-17 v 2.2.1: 2012			
EMISSION			
Standard	Test Type	Result	Remarks
EN 55022: 2010+AC: 2011	Mains Terminal Disturbance Voltage Test	PASS	Uncertainty: 2.7dB
	Radiated Emission Test	PASS	Uncertainty: 3.4dB
EN 61000-3-2: 2014	Harmonic current emission	PASS	Meets the requirements.
EN 61000-3-3: 2013	Voltage fluctuations & flicker	PASS	Meets the requirements.
IMMUNITY			
Standard	Test Type	Result	Remarks
EN 61000-4-2: 2009	Electrostatic discharge immunity test	PASS	Meets the requirements of Performance Criterion B
EN 61000-4-3: 2006+A2: 2010	Radio-frequency, electromagnetic field immunity test	PASS	Meets the requirements of Performance Criterion A
EN 61000-4-4: 2012	Electrical fast transient/ burst immunity test	PASS	Meets the requirements of Performance Criterion B
EN 61000-4-5: 2014	Surge immunity test	PASS	Meets the requirements of Performance Criterion B
EN 61000-4-6: 2014	Injected Currents immunity test	PASS	Meets the requirements of Performance Criterion A
EN 61000-4-11: 2004	Voltage Dips and Interruptions	PASS	Meets the requirements of Performance Criterion B&C

3. TEST METHODOLOGY

As per table 2 of clause 7.1 of ETSI EN 301 489-1 V1.9.2, the measurement was performed under EUT combined condition during the tests. The ports on the ancillary left empty during the measurement in this report.

4. MEASURING INSTRUMENT CALIBRATION

The measuring equipment, which was utilized in performing the tests documented herein, has been calibrated in accordance with the manufacturer's recommendations for utilizing calibration equipment, which is traceable to recognized national standards.

5. TEST FACILITY

Site Description

EMC Lab : Listed by CNAS, August 14, 2015
The certificate is valid until August 13, 2018
The Laboratory has been assessed and proved to be in compliance with CNAS/CL01
The Certificate Registration Number is L5795.

Listed by FCC, July 03, 2014
The Certificate Number is 665078.

Listed by Industry Canada, June 18, 2014
The Certificate Registration Number. Is 46405-9743

Name of Firm 1 : Dongguan Nore Testing Center Co., Ltd.
(Dongguan NTC Co., Ltd.)

Site Location 1 : Building D, Gaosheng Science & Technology Park,
Zhouxi Longxi Road, Nancheng District, Dongguan
City, Guangdong Province, China

Name of Firm 2 : Bureau Veritas Shenzhen Co., Ltd., Dongguan
Branch

Site Location 2 : No. 34, Chenwulu Section, Guantai Rd., Houjie
Town, Dongguan City, Guangdong 523942, China

6. SUPPORT EQUIPMENT

No.	Equipment	Model	Serial No.	Trade name	Data Cable	Power Cord
1	Mobile phone	X5SL	867048023 930426	Vivo	1.5m unshielded	N/A
2.	iPhone	iPhone 4	84133UUVA 4S	Apple	N/A	N/A

7. PERFORMANCE CRITERIA

ETSI EN301489-17 v 2.2.1: 2012		
Criteria	During Test	After Test
A	Shall operate as intended May show degradation of performance (note 1) Shall be no loss of function Shall be no unintentional transmissions	Shall operate as intended Shall be no degradation of performance (note 2) Shall be no loss of function Shall be no loss of stored data or user programmable functions
B	May show loss of function (one or more) May show degradation of performance (note 1) No unintentional transmissions	Functions shall be self-recoverable Shall operate as intended after recovering Shall be no degradation of performance (note 2) Shall be no loss of stored data or user programmable functions
C	May be loss of function (one or more)	Functions shall be recoverable by the operator Shall operate as intended after recovering Shall be no degradation of performance (note 2)
<p>NOTE 1: Degradation of performance during the test is understood as a degradation to a level not below a minimum performance level specified by the manufacturer for the use of the apparatus as intended. In some cases the specified minimum performance level may be replaced by a permissible degradation of performance. If the minimum performance level or the permissible performance degradation is not specified by the manufacturer then either of these may be derived from the product description and documentation (including leaflets and advertising) and what the user may reasonably expect from the apparatus if used as intended.</p> <p>NOTE 2: No degradation of performance after the test is understood as no degradation below a minimum performance level specified by the manufacturer for the use of the apparatus as intended. In some cases the specified minimum performance level may be replaced by a permissible degradation of performance. After the test no change of actual operating data or user retrievable data is allowed. If the minimum performance level or the permissible performance degradation is not specified by the manufacturer then either of these may be derived from the product description and documentation (including leaflets and advertising) and what the user may reasonably expect from the apparatus if used as intended.</p>		

Performance Criteria For Continuous Phenomena (CT & CR)

At the conclusion of the test the EUT shall operated as intended with no loss of user control functions or stored data, the communication link shall have been maintained during the test.

Performance Criteria For Transient Phenomena (TT & TR)

At the conclusion of each exposure the EUT shall operated with no user noticeable loss of communication link.

8. ETSI EN 301 489-1/-17 REQUIREMENTS

8.1 RADIATED EMISSION LIMIT

According standard ETSI EN 301 489-1 v 1.9.2 Clause 8.2.3, Table 3 and EN 55022: 2010+AC: 2011 Clause 6, Table 6, Class B

Limits for radiated disturbance Blow 1GHz

FREQUENCY (MHz)	DISTANCE (Meters)	FIELD STRENGTHS LIMIT (dB μ V/m)
30 ~ 230	3	40
230 ~ 1000	3	47

Note: (1) The smaller limit shall apply at the combination point between two frequency bands.
 (2) Distance refers to the distance in meters between the measuring instrument antenna and the closed point of any part of the EUT.

Limits for radiated disturbance Above 1GHz

FREQUENCY (MHz)	DISTANCE (Meters)	Average Limit (dB μ V/m)	Peak Limit
1000 ~ 3000	3	50	70
3000 ~ 6000	3	54	74

Note: The lower limit applies at the transition frequency.

TEST CONFIGURATION

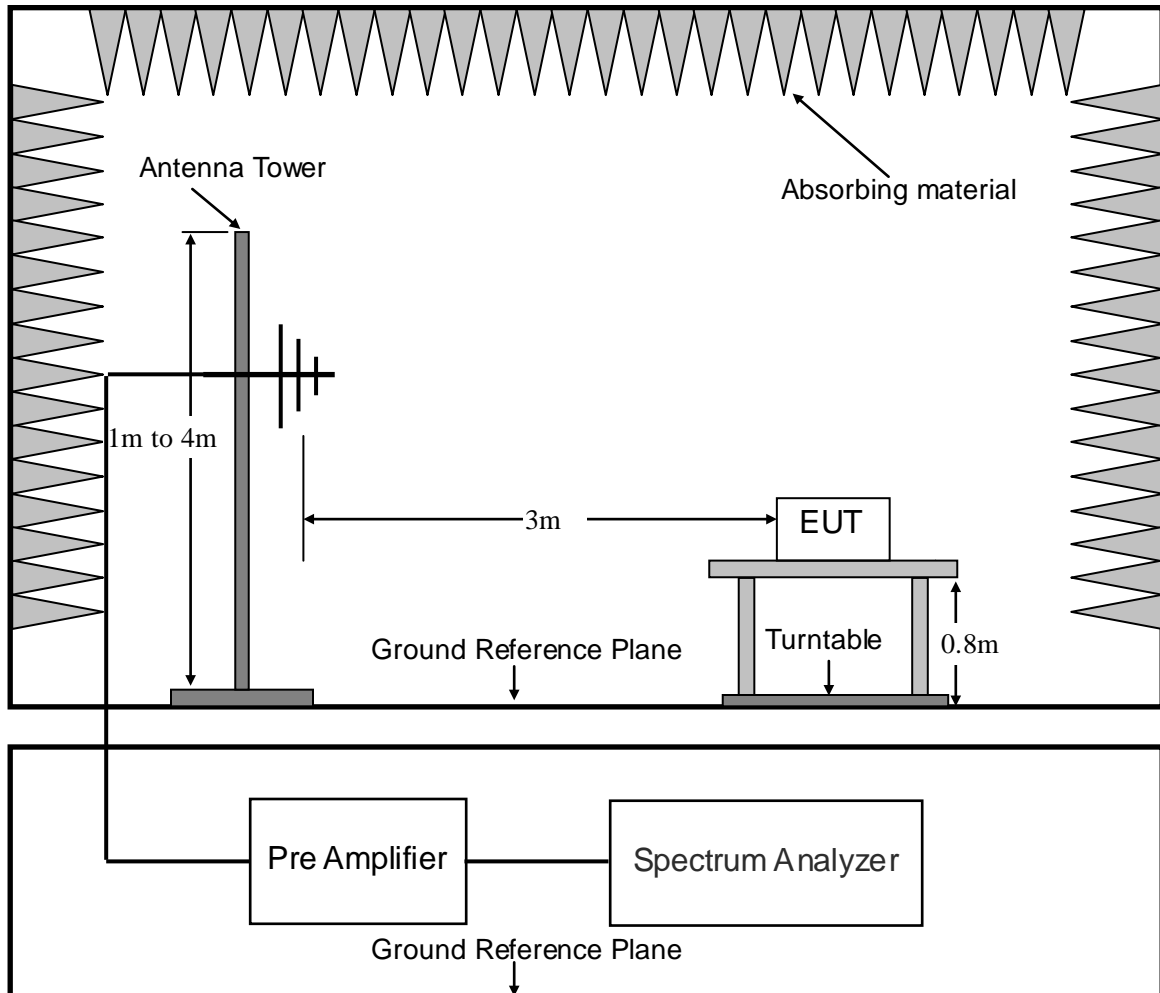

TEST PROCEDURE

Please refer to ETSI EN 301 489-1 v1.9.2 Clause 8.2.3 and EN 55022: 2010+AC: 2011 Clause 6 for the measurement methods.

TEST RESULT

PASS

Please refer to following data tables.



Dongguan NTC Co., Ltd.
Tel: +86-769-22022444 Fax: +86-769-22022799
Web: [Http://www.ntc-c.com](http://www.ntc-c.com)

Site: Radiation

Test Time: 2016-11-30 11:04:19

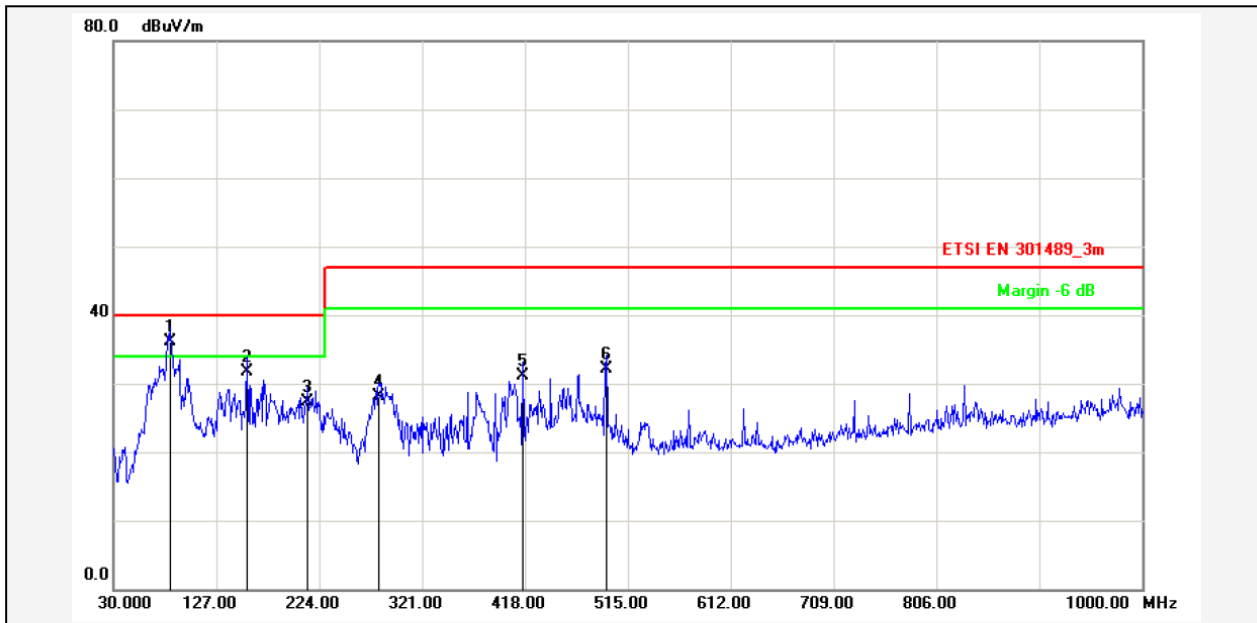

Report No.: F5060X	Test Standard: ETSI EN 301489_3m	Test Distance: 3m
Test item: Radiation Emission	Ant. Polarization: Horizontal	Temp.(C)/Hum.(%): 22(C) / 54 %
Applicant: FENDA	Power Rating: AC 230V/50Hz	Test Engineer: Chilam
Product: 5.1 Speaker System		
Model No.: F5060X		

Test Mode: BT Link
Remark:

No.	Frequency (MHz)	Factor (dB/m)	Reading (dBuV)	Level (dBuV/m)	Limit (dBuV/m)	Margin (dB)	Detector	Height (cm)	Azimuth (deg.)	P/F	Remark
1	83.3499	-15.50	51.70	36.20	40.00	-3.80	QP			P	
2	156.0997	-15.32	47.12	31.80	40.00	-8.20	QP			P	
3	213.3300	-13.16	40.56	27.40	40.00	-12.60	QP			P	
4	280.2599	-10.97	39.07	28.10	47.00	-18.90	QP			P	
5	416.0600	-8.73	39.83	31.10	47.00	-15.90	QP			P	
6	494.6299	-6.88	39.08	32.20	47.00	-14.80	QP			P	



Dongguan NTC Co., Ltd.
 Tel:+86-769-22022444 Fax:+86-769-22022799
 Web: [Http://www.ntc-c.com](http://www.ntc-c.com)

Site: Radiation

Test Time: 2016-11-30 10:57:00

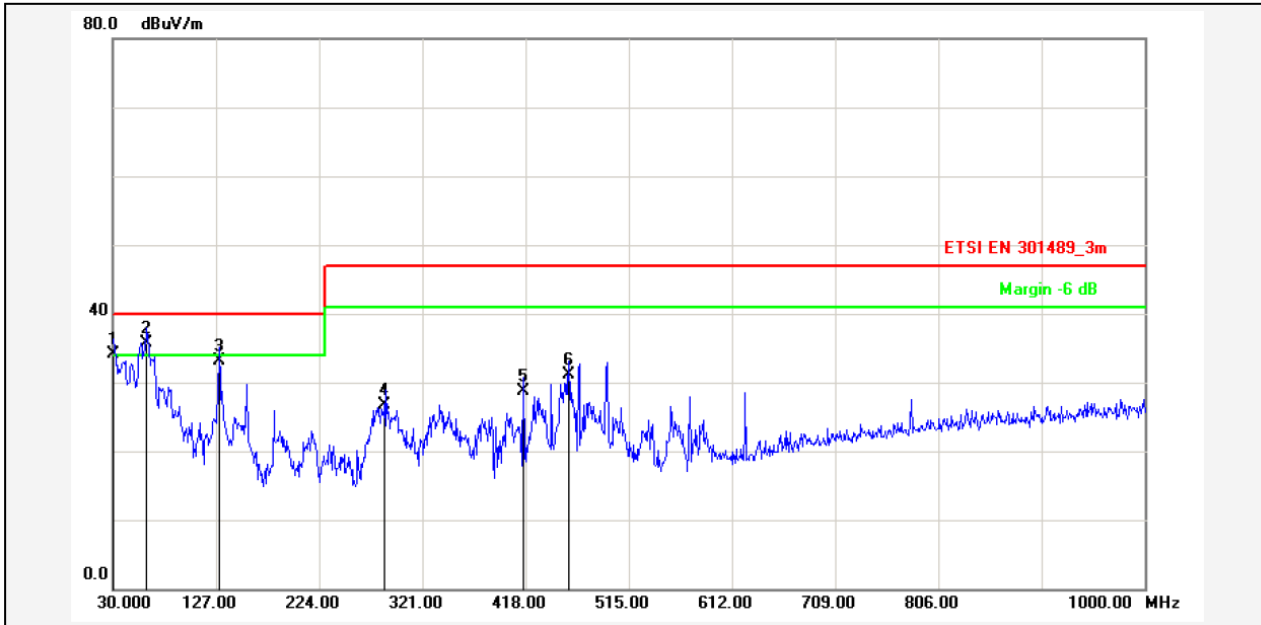

Report No.: F5060X
 Test Standard: ETSI EN 301489_3m
 Test item: Radiation Emission
 Applicant: FENDA
 Product: 5.1 Speaker System
 Model No.: F5060X

Test Distance: 3m
 Ant. Polarization: Vertical
 Temp.(C)/Hum.(%): 22(C) / 54 %
 Power Rating: AC 230V/50Hz
 Test Engineer: Chilam

Test Mode: BT Link
 Remark:

No.	Frequency (MHz)	Factor (dB/m)	Reading (dBuV)	Level (dBuV/m)	Limit (dBuV/m)	Margin (dB)	Detector	Height (cm)	Azimuth (deg.)	P/F	Remark
1	30.9695	-15.83	50.03	34.20	40.00	-5.80	QP			P	
2	62.0099	-14.84	50.64	35.80	40.00	-4.20	QP			P	
3	129.9096	-18.15	51.25	33.10	40.00	-6.90	QP			P	
4	286.0799	-12.85	39.65	26.80	47.00	-20.20	QP			P	
5	416.0600	-11.53	40.23	28.70	47.00	-18.30	QP			P	
6	458.7400	-9.82	41.02	31.20	47.00	-15.80	QP			P	



Dongguan NTC Co., Ltd.
Tel: +86-769-22022444 Fax: +86-769-22022799
Web: [Http://www.ntc-c.com](http://www.ntc-c.com)

Site: Radiation

Test Time: 2016-11-30 14:30:10

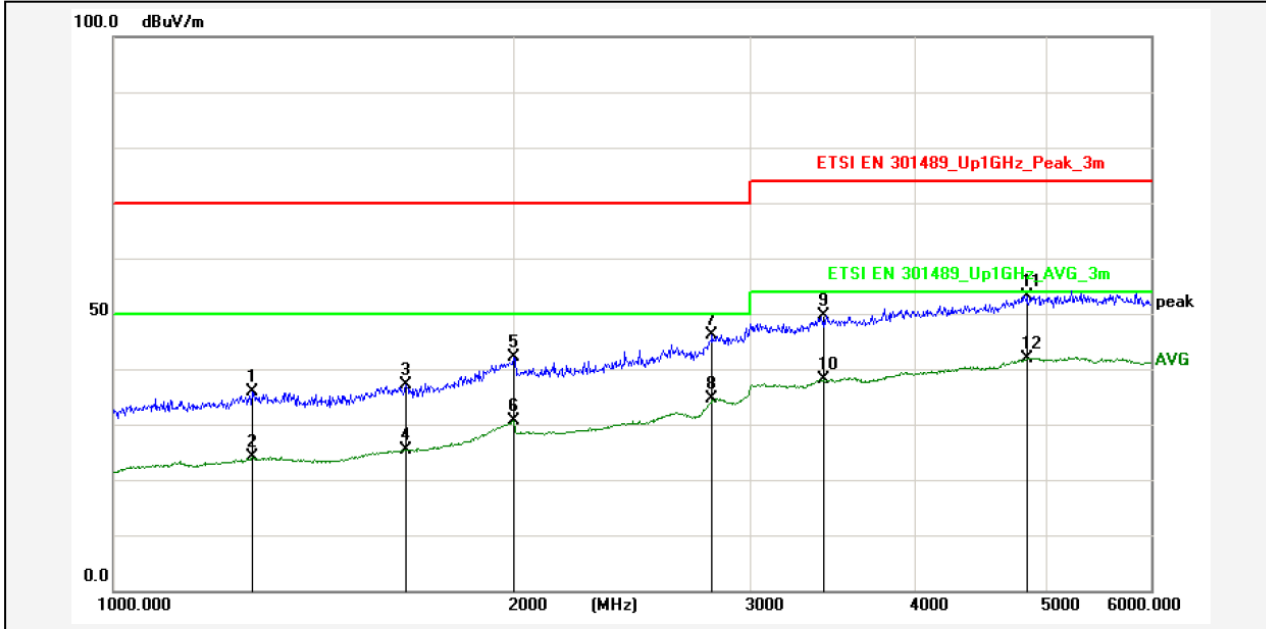

Report No.: F5060X
 Test Standard: ETSI EN 301489_Up1GHz_Peak_3m
 Test item: Radiation Emission
 Applicant: FENDA
 Product: 5.1 Speaker System
 Model No.: F5060X
 Test Distance: 3m
 Ant. Polarization: Horizontal
 Temp.(C)/Hum.(%): 22(C) / 54 %
 Power Rating: AC 230V/50Hz
 Test Engineer: Chilam

Test Mode: BT Link
 Remark:

No.	Frequency (MHz)	Factor (dB/m)	Reading (dBuV)	Level (dBuV/m)	Limit (dBuV/m)	Margin (dB)	Detector	Height (cm)	Azimuth (deg.)	P/F	Remark
1	1271.371	-7.17	43.08	35.91	70.00	-34.09	peak			P	
2	1271.371	-7.17	31.19	24.02	50.00	-25.98	AVG			P	
3	1657.443	-5.33	42.52	37.19	70.00	-32.81	peak			P	
4	1657.443	-5.33	30.80	25.47	50.00	-24.53	AVG			P	
5	1996.946	-0.89	43.11	42.22	70.00	-27.78	peak			P	
6	1996.946	-0.89	31.58	30.69	50.00	-19.31	AVG			P	
7	2811.857	1.41	44.77	46.18	70.00	-23.82	peak			P	
8	2811.857	1.41	33.18	34.59	50.00	-15.41	AVG			P	
9	3406.085	2.50	47.22	49.72	74.00	-24.28	peak			P	
10	3406.085	2.50	35.68	38.18	54.00	-15.82	AVG			P	
11	4839.195	6.44	46.73	53.17	74.00	-20.83	peak			P	
12	4839.195	6.44	35.51	41.95	54.00	-12.05	AVG			P	



Dongguan NTC Co., Ltd.
Tel: +86-769-22022444 Fax: +86-769-22022799
Web: [Http://www.ntc-c.com](http://www.ntc-c.com)

Site: Radiation

Test Time: 2016-11-30 14:37:38

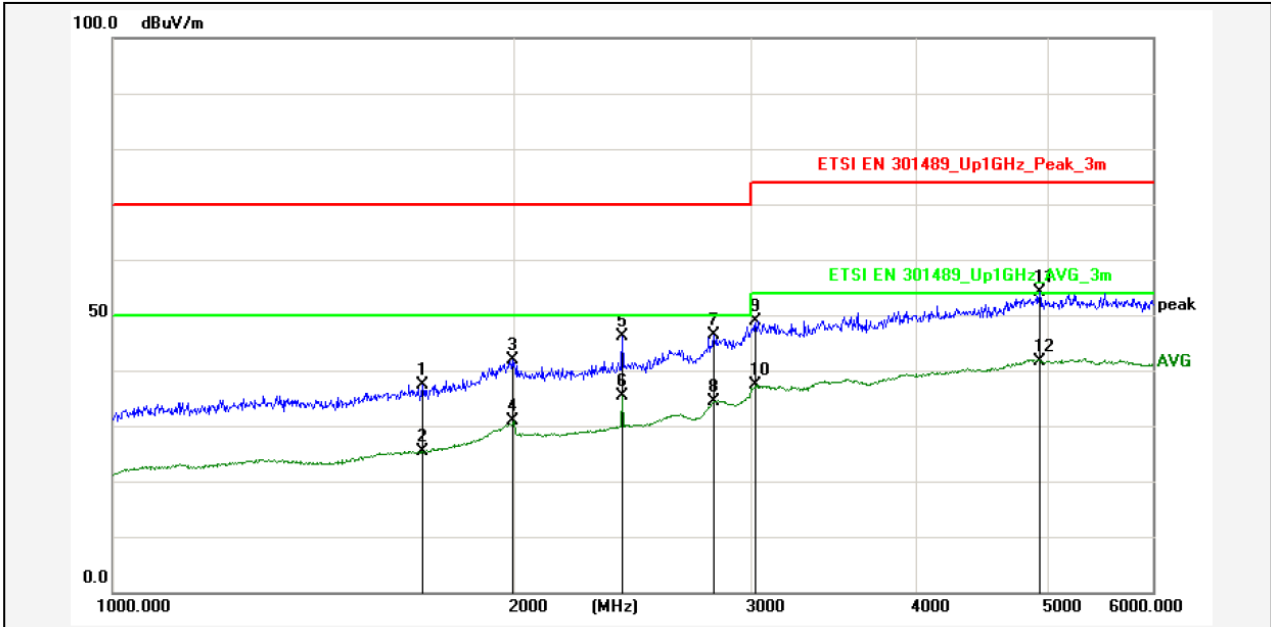

Report No.: F5060X
 Test Standard: ETSI EN 301489_Up1GHz_Peak_3m
 Test item: Radiation Emission
 Applicant: FENDA
 Product: 5.1 Speaker System
 Model No.: F5060X
 Test Distance: 3m
 Ant. Polarization: Vertical
 Temp.(C)/Hum.(%): 22(C) / 54 %
 Power Rating: AC 230V/50Hz
 Test Engineer: Chilam

Test Mode: BT Link

Remark:

No.	Frequency (MHz)	Factor (dB/m)	Reading (dBuV)	Level (dBuV/m)	Limit (dBuV/m)	Margin (dB)	Detector	Height (cm)	Azimuth (deg.)	P/F	Remark
1	1705.647	-4.71	42.19	37.48	70.00	-32.52	peak			P	
2	1705.647	-4.71	30.15	25.44	50.00	-24.56	AVG			P	
3	1989.803	-0.98	42.82	41.84	70.00	-28.16	peak			P	
4	1989.803	-0.98	31.75	30.77	50.00	-19.23	AVG			P	
5	2405.992	0.14	45.95	46.09	70.00	-23.91	peak			P	
6	2405.992	0.14	35.23	35.37	50.00	-14.63	AVG			P	
7	2816.900	1.42	44.91	46.33	70.00	-23.67	peak			P	
8	2816.900	1.42	33.07	34.49	50.00	-15.51	AVG			P	
9	3031.626	1.84	46.99	48.83	74.00	-25.17	peak			P	
10	3031.626	1.84	35.47	37.31	54.00	-16.69	AVG			P	
11	4935.518	6.81	47.27	54.08	74.00	-19.92	peak			P	
12	4935.518	6.81	34.91	41.72	54.00	-12.28	AVG			P	

8.2 AC POWER CONDUCTED EMISSION

LIMIT

According to standard ETSI EN 301 489-1 v1.9.2 Clause 8.3.3, Table 8 and EN 55022: 2010+AC: 2011 Clause 5, Table 2, Class B

Limits for conducted disturbance at the mains ports of class B ITE.

Frequency range (MHz)	Limits (dB(uV))	
	Quasi-peak	Average
0.15 to 0.5	66 to 56	56 to 46
0.5 to 5	56	46
5 to 30	60	50

TEST CONFIGURATION

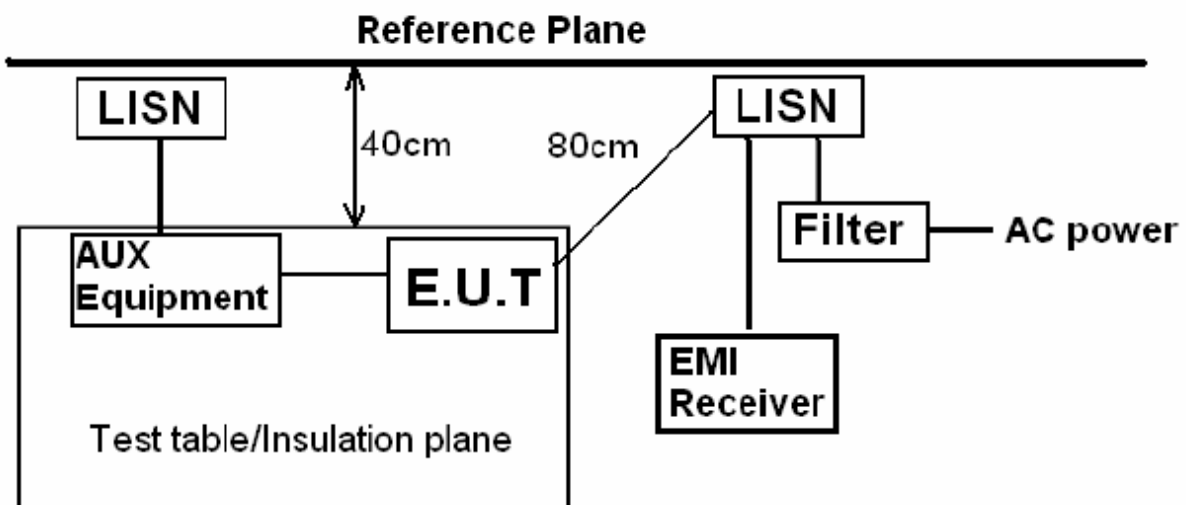

TEST PROCEDURE

Please refer to ETSI EN 301 489-1 v1.9.2 Clause 8.3.3 and EN 55022: 2010+AC: 2011 Clause 5 for the measurement methods.

TEST RESULTS

PASS

Please refer to following data tables.



Dongguan NTC Co., Ltd.
 Tel: +86-769-22022444 Fax: +86-769-22022799
 Web: [Http://www.ntc-c.com](http://www.ntc-c.com)

Site: Conduction

Test Time: 2016-12-6 14:34:07

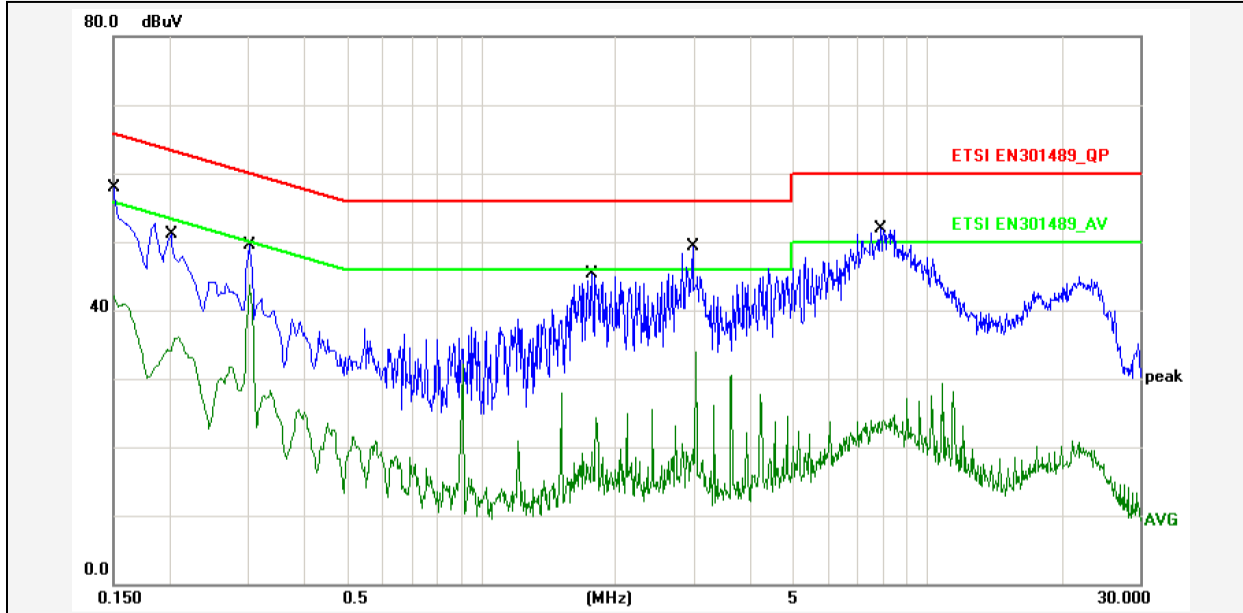

Report No.: F5060X
 Test Standard: ETSI EN301489_QP
 Test item: Conducted Emission
 Applicant: FENDA
 Product: 5.1 Speaker System
 Model No.: F5060X

Phase: L1
 Temp.()/Hum.(%): 22(C) / 52 %
 Power Rating: AC 230V/50Hz
 Test Engineer: Jerry

Test Mode: BT Link
 Remark:

No.	Frequency (MHz)	Factor (dBuV)	Reading (dBuV)	Level (dBuV)	Limit (dBuV)	Margin (dB)	Detector	P/F	Remark
1	0.1500	10.80	46.00	56.80	65.99	-9.19	QP	P	
2	0.1500	10.80	30.38	41.18	55.99	-14.81	AVG	P	
3	0.2020	10.80	39.20	50.00	63.52	-13.52	QP	P	
4	0.2020	10.80	24.40	35.20	53.52	-18.32	AVG	P	
5	0.3019	10.80	37.30	48.10	60.19	-12.09	QP	P	
6	0.3019	10.80	32.03	42.83	50.19	-7.36	AVG	P	
7	1.7740	10.80	33.46	44.26	56.00	-11.74	QP	P	
8	1.7740	10.80	12.60	23.40	46.00	-22.60	AVG	P	
9	2.9820	10.80	37.80	48.60	56.00	-7.40	QP	P	
10	2.9820	10.80	21.20	32.00	46.00	-14.00	AVG	P	
11	7.8859	10.80	40.00	50.80	60.00	-9.20	QP	P	
12	7.8859	10.80	12.00	22.80	50.00	-27.20	AVG	P	



Dongguan NTC Co., Ltd.
Tel: +86-769-22022444 Fax: +86-769-22022799
Web: [Http://www.ntc-c.com](http://www.ntc-c.com)

Site: Conduction

Test Time: 2016-12-6 14:41:04

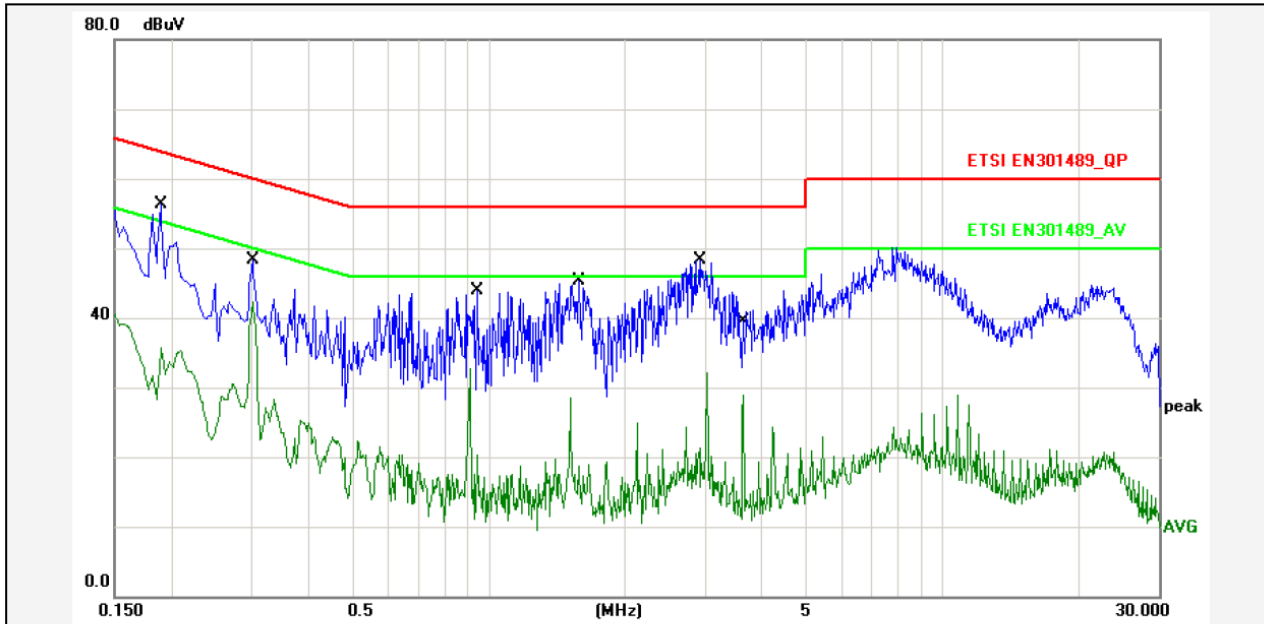

Report No.: F5060X
Test Standard: ETSI EN301489_QP
Test item: Conducted Emission
Applicant: FENDA
Product: 5.1 Speaker System
Model No.: F5060X
Phase: N
Temp.()/Hum.(%): 22(C) / 52 %
Power Rating: AC 230V/50Hz
Test Engineer: Jerry

Test Mode: BT Link
Remark:

No.	Frequency (MHz)	Factor (dBuV)	Reading (dBuV)	Level (dBuV)	Limit (dBuV)	Margin (dB)	Detector	P/F	Remark
1	0.1900	10.80	44.20	55.00	64.03	-9.03	QP	P	
2	0.1900	10.80	24.00	34.80	54.03	-19.23	AVG	P	
3	0.3019	10.80	36.70	47.50	60.19	-12.69	QP	P	
4	0.3019	10.80	31.00	41.80	50.19	-8.39	AVG	P	
5	0.9460	10.80	20.86	42.50	56.00	-13.50	QP	P	
6	0.9460	10.80	31.70	31.66	46.00	-13.34	AVG	P	
7	1.5820	10.80	33.30	44.10	56.00	-11.90	QP	P	
8	1.5820	10.80	16.71	27.51	46.00	-18.49	AVG	P	
9	2.9219	10.80	36.70	47.50	56.00	-8.50	QP	P	
10	2.9219	10.80	20.40	31.20	46.00	-14.80	AVG	P	
11	3.6420	10.80	28.68	39.48	56.00	-16.52	QP	P	
12	3.6420	10.80	17.00	27.80	46.00	-18.20	AVG	P	

8.3 AC MAINS HARMONIC CURRENT EMISSION

LIMIT

Please refer to EN 61000-3-2

TEST CONFIGURATION

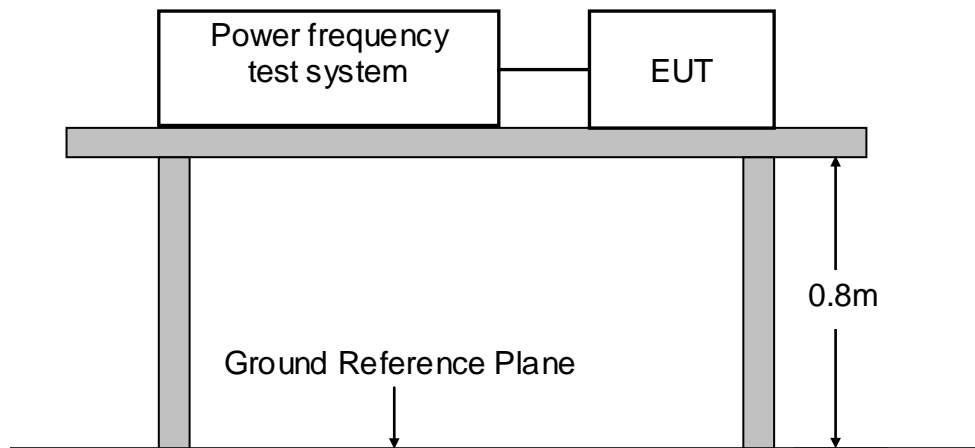

Ambient Condition of the Test Site			
Temperature	22°C	Test Voltage	AC 230V/50Hz
Humidity	49%RH	Tested by	Sance
Pressure	1022mbar		

TEST PROCEDURE

Please refer to EN 61000-3-2 for the measurement methods.

TEST RESULTS

Pass

Test Mode: BT Link

According to clause 7 of EN 61000-3-2, equipment with a rated power of 75W or less, no limits apply. It is considered to meet the requirements of the standard.

8.4 AC MAINS VOLTAGE FLUCTUATION AND FLICKER

LIMIT

Please refer to EN 61000-3- 3

TEST CONFIGURATION

(Same as the configuration of the AC MAINS HARMONIC CURRENT EMISSIONS TEST)

Ambient Condition of the Test Site			
Temperature	22°C	Test Voltage	AC 230V/50Hz
Humidity	49%RH	Tested by	Sance
Pressure	1022mbar		

TEST PROCEDURE

Please refer to EN 61000-3- 3 for the measurement methods.

TEST RESULTS

No non-compliance noted.

Test Mode : BT Link

Flicker Test Summary per EN/IEC61000-3-3 Ed. 3.0 (2013) (Run time)

EUT: 5.1 Speaker System Tested by: Ryan
Test category: All parameters (European limits) Test Margin: 100
Test date: 2016-10-1 Start time: 10:06:09 End time: 10:16:40
Test duration (min): 10 Data file name: F-000136.cts_data
Comment: BT Link
Customer: FENDA
M/N: F5060X
Test Result: Pass Status: Test Completed

Psti and limit line

European Limits

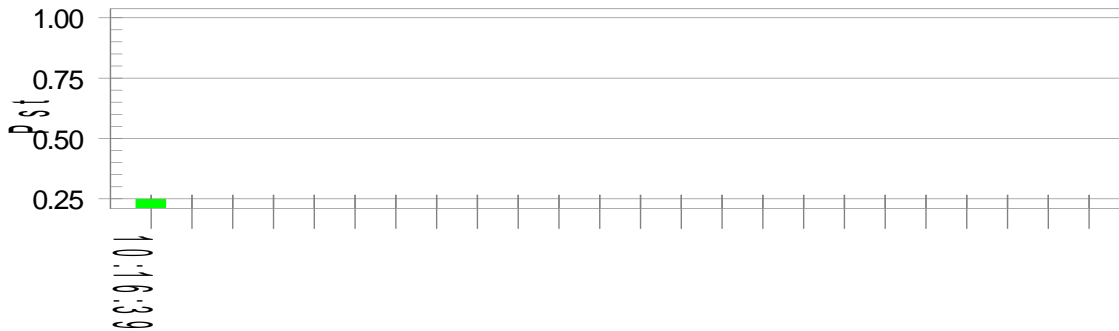

Plt and limit line

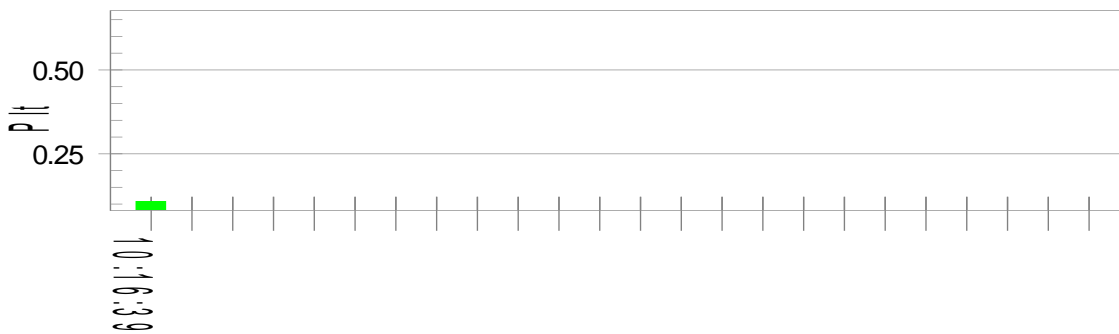

Parameter values recorded during the test:

Vrms at the end of test (Volt):	230.34		
Highest dt (%):	0.00	Test limit (%):	N/A N/A
T-max (mS):	0	Test limit (mS):	500.0 Pass
Highest dc (%):	0.00	Test limit (%):	3.30 Pass
Highest dmax (%):	0.05	Test limit (%):	4.00 Pass
Highest Pst (10 min. period):	0.248	Test limit:	1.000 Pass
Highest Plt (2 hr. period):	0.108	Test limit:	0.650 Pass

8.5 ELECTROSTATIC DISCHARGE

TEST CONFIGURATION

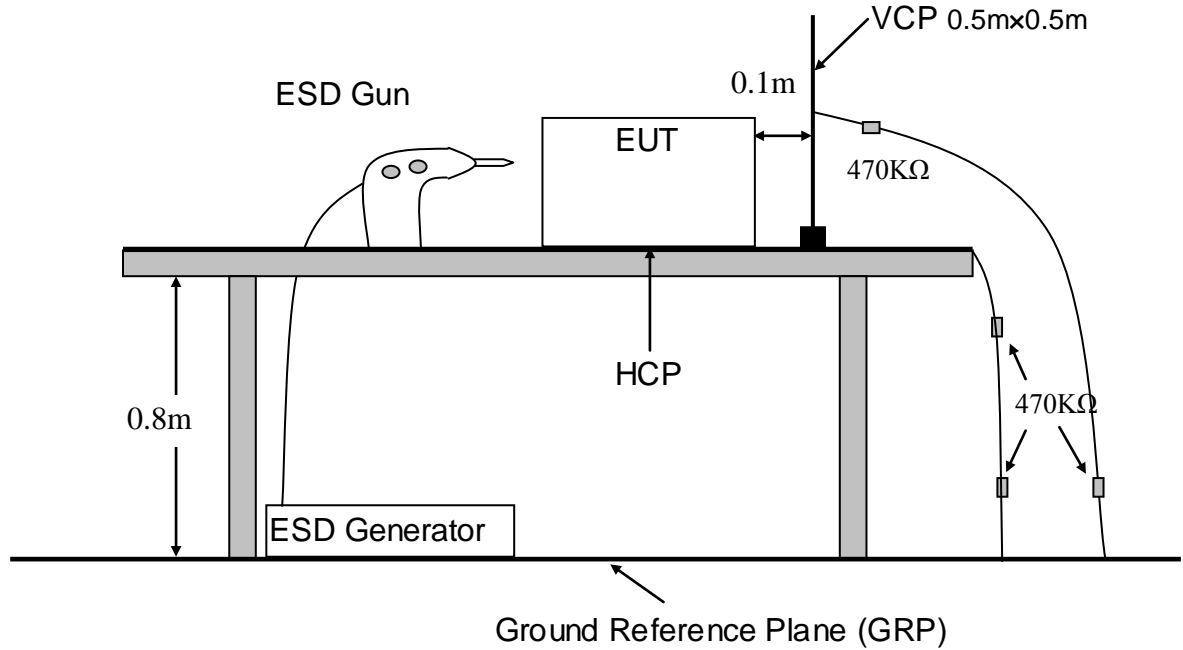

TEST PROCEDURE:

Please refer to ETSI EN 301 489-1 v1.9.2 Clause 9.3.2 and EN 61000-4-2 for the measurement methods.

TEST RESULT

PASS

please refer to following data table.

Test Condition			
Temperature	22°C	Test Voltage	AC 230V/50Hz
Humidity	49%RH	Tested by	Ryan
Pressure	1022mbar	Performance Criterion :	CR & CT & B
Ground Bond Resistance		0.2 Ω	
Time Between Each Discharge :		1 second	
Test Mode		BT Link	
Test Level		± 2.0, ± 4.0, ±8.0 kV (Air Discharge) ± 2.0, ±4.0 kV (Contact Discharge) ± 2.0, ±4.0 kV (Indirect Contact Discharge)	
Test Result			
Discharge Type	Level		Result
Contact Discharge	± 2, ± 4kV		Pass*
Air Discharge	± 2, ± 4, ± 8kV		Pass*
Indirect HCP Discharge	± 2, ± 4kV		Pass
Indirect VCP Discharge	± 2, ± 4kV		Pass

Note: The EUT Power off during the test, but it can be resumed to normal operation by user after test. After consider with client's confirmation that relevant instruction will be mentioned in the manual, so the test result was considered to be passed.

8.6 RF ELECTROMAGNETIC FIELD

TEST CONFIGURATION

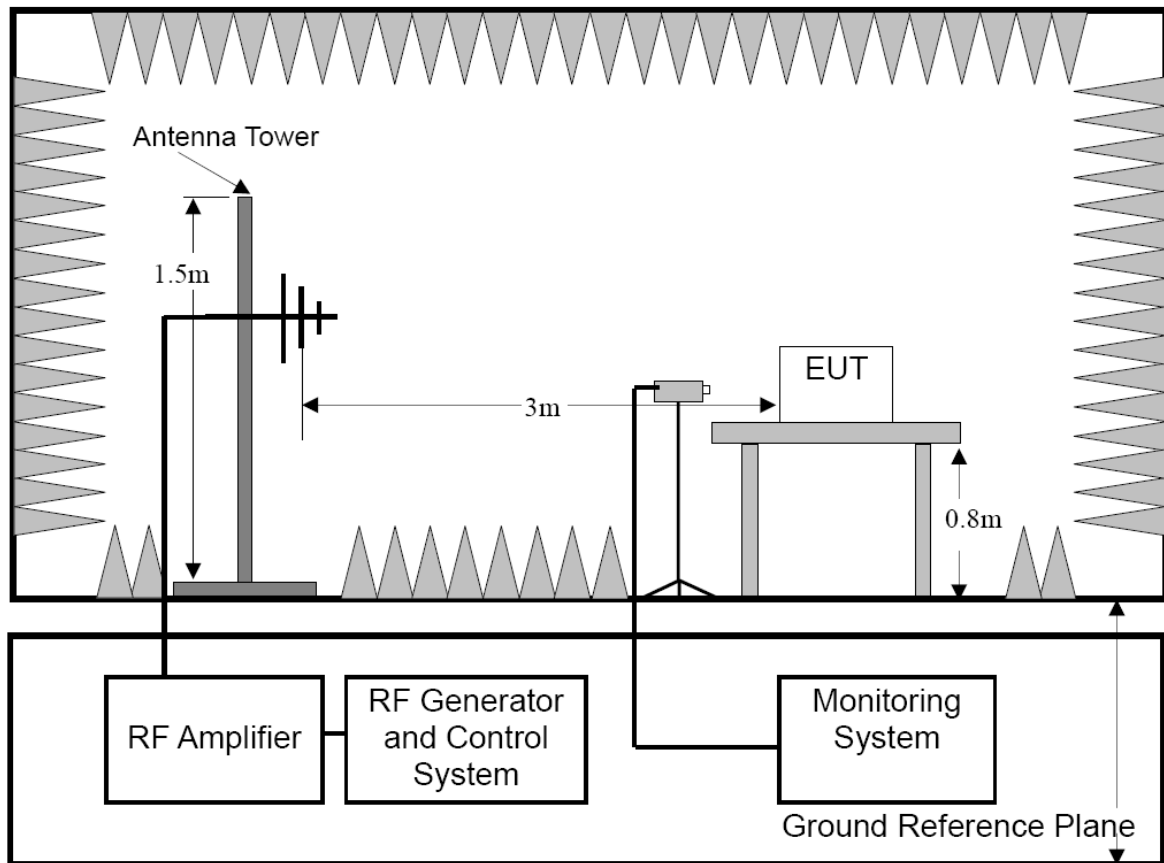

TEST PROCEDURE

Please refer to ETSI EN 301 489-1 v1.9.2 Clause 9.2.2 and EN61000-4-3 for the measurement methods.

TEST RESULT

PASS

please refer to following data table.

Test Condition			
Temperature	22°C	Test Voltage	AC 230V/50Hz
Humidity	49%RH	Tested by	Ryan
Pressure	1022mbar	Performance Criterion	CR & CT & A
Frequency Range	80-1000MHz and 1400-2700 MHz		
Test Modulation	1kHz, 80% AM		
Dwell time	1 second		
Frequency Step	1%		
Antenna Polarization	Horizontal and Vertical		
Test Mode	BT Link		
Test Level	3V/m		
Test Result			
Frequency (MHz)	Exposed Side		Result
80 to 1000 1400 to 2700	Front		Pass
80 to 1000 1400 to 2700	Left		Pass
80 to 1000 1400 to 2700	Rear		Pass
80 to 1000 1400 to 2700	Right		Pass

Note: The exclusion band for 2,45 GHZ equipment falling within the scope of the present document extends from 2 280 MHz to 2 607,675 MHz.

Note: This test was carry out on Bureau Veritas Shenzhen Co., Ltd., Dongguan Branch.

8.7 AC MAINS FAST TRANSIENTS COMMON MODE

TEST CONFIGURATION

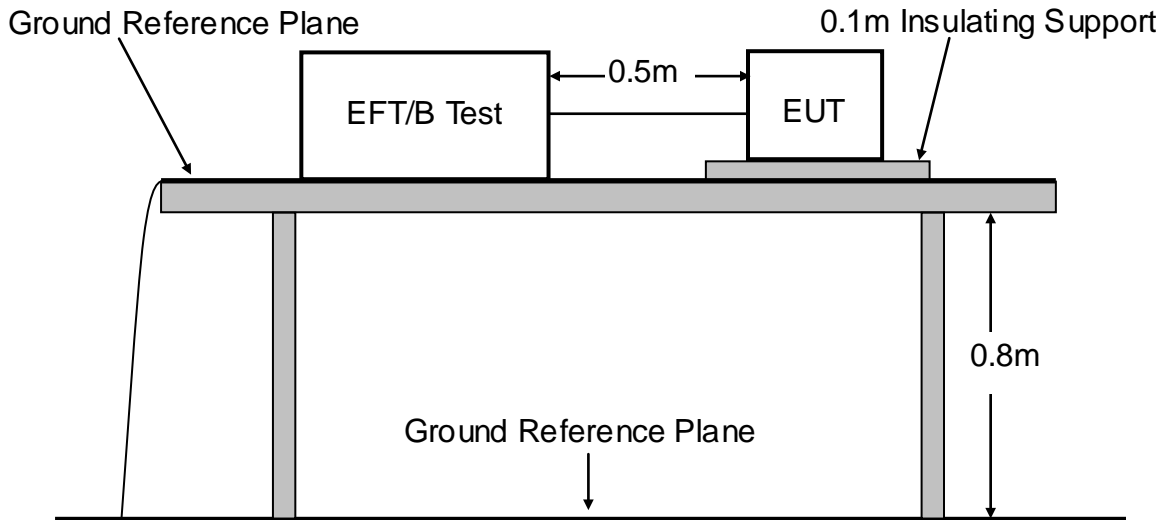

TEST PROCEDURE

Please refer to ETSI EN 301 489-1 v1.9.2 Clause 9.4.2 and EN 61000-4-4 for the measurement methods.

TEST RESULT

PASS

please refer to following data table.

Test Condition			
Temperature	22°C	Test Voltage	AC 230V/50Hz
Humidity	49%RH	Tested by	Ryan
Pressure	1022mbar	Performance Criterion	CR & CT & B
Impulse Frequency	5kHz		
Tr/Th	5/50ns		
Burst Duration	15ms		
Burst Period	300ms		
Port	AC Power		
Test Mode	BT Link		
Test Level	±1.0kV		
Test Result			
Injection Line	Level	Result	
Line	±1.0kV	Pass	
Neutral	±1.0kV	Pass	
PE	N/A	N/A	
Line + Neutral	±1.0kV	Pass	
Line + PE	N/A	N/A	
Neutral + PE	N/A	N/A	
DC Power Line	N/A	N/A	
Signal Line	N/A	N/A	

8.8 AC MAINS SURGE

TEST CONFIGURATION

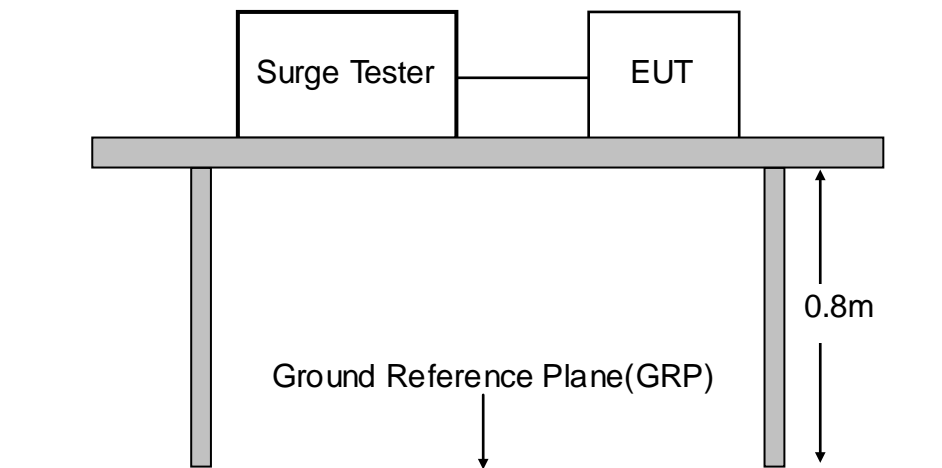

TEST PROCEDURE:

Please refer to ETSI EN 301 489-1 v1.9.2 Clause 9.8.2 and EN 61000-4-5 for the measurement methods.

TEST RESULT

PASS

please refer to following data table.

Test Condition			
Temperature	22°C	Test Voltage	AC 230V/50Hz
Humidity	49%RH	Tested by	Ryan
Pressure	1022mbar	Performance Criterion	CR & CT & B
Voltage Waveform		1.2/50 us	
Current Waveform		8/20 us	
Polarity		Positive/Negative	
Phase angle		0°, 90°, 180°, 270°	
Repetition Rate		1 minute	
Test Mode		BT Link	
Test Level		±1.0kV / 5 Positive And 5 Negative Surges	
Test Result			
Coupling Line	Level	Result	
Line + Neutral	±1.0kV	Pass	
Line + PE	N/A	N/A	
Neutral + PE	N/A	N/A	
T, R-Ground	N/A	N/A	
L1, 2, 3, 4-G (LAN)	N/A	N/A	

8.9 RADIO FREQUENCY COMMON MODE

TEST CONFIGURATION

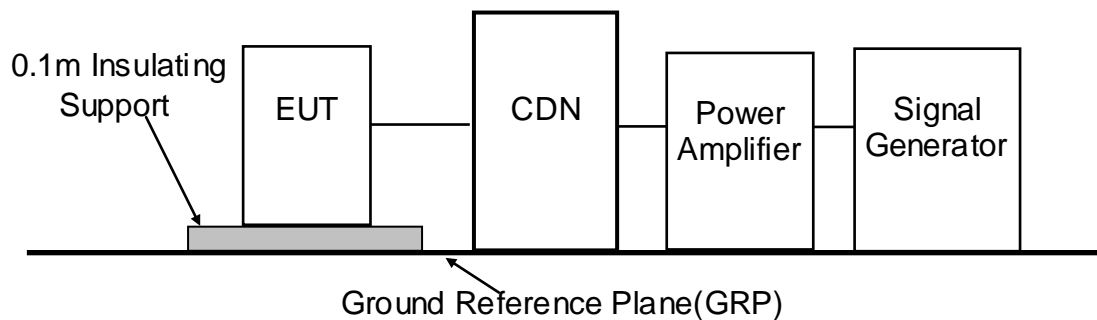

TEST PROCEDURE

Please refer to ETSI EN 301 489-1 v1.9.2 Clause 9.5.2, EN61000-4-6 for the measurement methods.

TEST RESULT

PASS

please refer to following data table.

Test Condition			
Temperature	22°C	Test Voltage	AC 230V/50Hz
Humidity	49%RH	Tested by	Ryan
Pressure	1022mbar	Performance Criterion	CR & CT & A
Frequency Range	0.15MHz~80MHz		
Frequency Step	1%		
Dwell time	1s		
Test Modulation	1 kHz, 80% AM		
Source Impedance	150Ω		
Test Mode	BT Link		
Test Level	3V(r.m.s)		
Test Result			
Injection Line	Level	Result	
AC Power Line	3V(r.m.s)	Pass	
Telecommunication Line	N/A	N/A	
DC Line	N/A	N/A	
Signal Line	N/A	N/A	
Control Line	N/A	N/A	

Note: This test was carry out on Bureau Veritas Shenzhen Co., Ltd., Dongguan Branch.

8.10 VOLTAGE DIPS AND INTERRUPTION

TEST CONFIGURATION

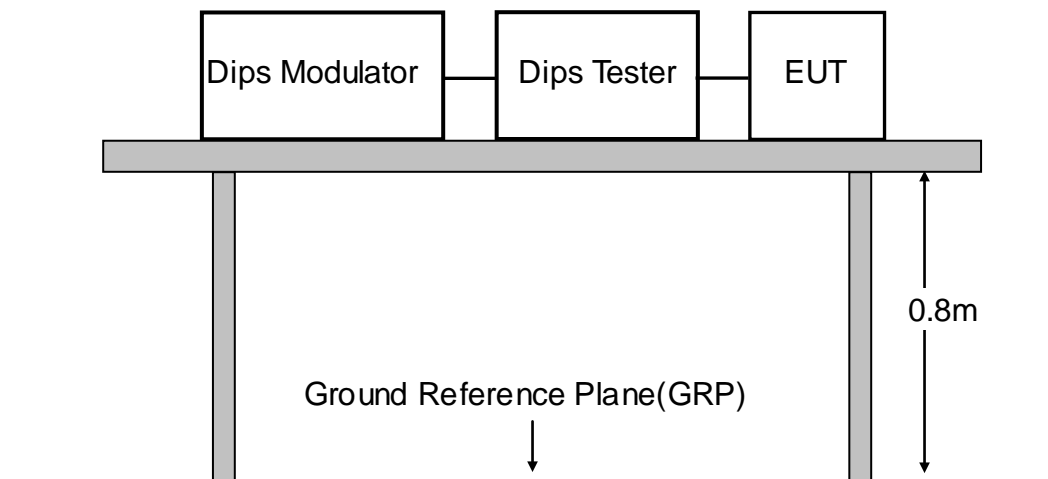

TEST PROCEDURE

Please refer to ETSI EN 301 489-1 V1.9.2 Clause 9.7.2 and EN 61000-4-11 for the measurement methods.

TEST RESULT

PASS

please refer to following data table.

Test Condition				
Temperature	22°C	Test Voltage	AC 230V 50Hz	
Humidity	49%RH	Tested by	Ryan	
Pressure	1022mbar	Performance Criterion	B&C	
Phase angles	0°, 45°, 90°, 135°, 180°, 225°, 270°, 315°			
Number of Dips/Interruptions :	3 times			
Repetition Rate	10s			
Test Mode	BT Link			
Test Level				
	Test Level (% U _T)	Reduction (%)	Duration (ms)	Criterion
Voltage Dips	70	30%	500	B
	0	100%	20	B
	0	100%	10	B
Voltage Interruption	0	100%	5000	C
Test Result				
	Test Level (% U _T)	Reduction (%)	Duration (ms)	Result
	70	30%	500	Pass
	0	100%	20	Pass
	0	100%	10	Pass
	0	100%	5000	Pass*

Note: The EUT power off during the test, and it could be recovered by users after test.

8.11 TEST EQUIPMENT LIST

FOR MAINS TERMINALS DISTURBANCE VOLTAGE TEST

Item	Equipment	Manufacturer	Model No.	Serial No.	Last Cal.	Cal. Interval
1.	Test Receiver	Rohde & Schwarz	ESCI	101152	Mar. 07, 2016	1 Year
2.	L.I.S.N	Rohde & Schwarz	ENV 216	101317	Mar. 07, 2016	1 Year
3.	L.I.S.N	Schwarzbeck	NNLK8129	8129-212	Mar. 07, 2016	1 Year
4.	RF Switching Unit	Compliance Direction Systems Inc.	RSU-M2	38311	Mar. 07, 2016	1 Year
5.	Pulse Limiter	MTS-systemtechnik	MTS-IMP-136	26115-010-0007	Mar. 07, 2016	1 Year

FOR RADIATED EMISSION MEASUREMENT

Item	Equipment	Manufacturer	Model No.	Serial No.	Last Cal.	Cal. Interval
1.	Test Receiver	Rohde & Schwarz	ESCI7	100837	Mar. 07, 2016	1 Year
2.	Antenna	Schwarzbeck	VULB9162	9162-010	Apr. 25, 2016	1 Year
3.	Cable	Huber+Suhner	CBL3-NN-9M	21490001	Mar. 07, 2016	1 Year
4.	Cable	Huber+Suhner	CIL02	N/A	Mar. 07, 2016	1 Year
5.	Power Amplifier	HP	HP 8447D	1145A00203	Mar. 07, 2016	1 Year
6.	Horn Antenna	COM-Power	AH-118	071078	Mar. 07, 2016	1 Year
7.	Pre-Amplifier	COM-Power	PAM-118	443007	Mar. 07, 2016	1 Year

FOR HARMONIC / FLICKER MEASUREMENT

Item	Equipment	Manufacturer	Model No.	Serial No.	Last Cal.	Cal. Interval
1.	Power Frequency Test System	California Instruments	CTS	72846	Apr. 25, 2016	1 Year
2.	Software	California Instruments	CTS30	N/A	N/A	N/A

FOR ELECTROSTATIC DISCHARGE TEST

Item	Equipment	Manufacturer	Model No.	Serial No.	Last Cal.	Cal. Interval
1.	ESD Tester	TESEQ	NSG 437	432	Apr. 26, 2016	1 Year

FOR RF ELECTROMAGNETIC FIELD IMMUNITY TEST

(Bureau Veritas Shenzhen Co., Ltd., Dongguan Branch)

Item	Equipment	Manufacturer	Model No.	Serial No.	Last Cal.	Cal. Interval
1.	Signal Generator	Agilent	N5181A	MY50142530	Aug 31, 2016	1 Year
2.	Antenna Log-Periodic	CORAD	ATR80M6G	0337307	Aug 31, 2016	1 Year
3.	Switch Controller	CORAD	SC1000	0337343	Aug 31, 2016	1 Year
4.	RF Power Meter	ESE	4242	13984	Aug 31, 2016	1 Year
5	Power Sensor	ESE	51011EMC	35716	Aug 31, 2016	1 Year
6	E-Field probe	Narda	NBM-520	2403/01B	Aug 31, 2016	1 Year
7	Power Amplifier	TESEQ	CBA 1G-150	T44029	N/A	N/A
8	Power Amplifier	TESEQ	CBA 3G-100	T44030	N/A	N/A
9	Power Amplifier	TESEQ	CBA 6G-050	1041204	N/A	N/A
10	Dual Directional Coupler	TESEQ	C5982	95208	Aug 31, 2016	1 Year
11	Dual Directional Coupler	TESEQ	C6187	95175	Aug 31, 2016	1 Year
12	Dual Directional Coupler	TESEQ	CPH-274F	M251304-01	Aug 31, 2016	1 Year

FOR ELECTRICAL FAST TRANSIENT /BURST IMMUNITY TEST

Item	Equipment	Manufacturer	Model No.	Serial No.	Last Cal.	Cal. Interval
1.	Burst Tester	EM TEST	UCS 500N	V1104108683	Mar. 07, 2016	1 Year
2.	Coupling Clamp	EM TEST	HFK	0311-94	Mar. 07, 2016	1 Year
3.	Test Soft	EM TEST	lec. control	N/A	N/A	N/A

FOR SURGE IMMUNITY TEST

Item	Equipment	Manufacturer	Model No.	Serial No.	Last Cal.	Cal. Interval
1.	Surge Tester	EM TEST	UCS 500N	V1104108683	Mar. 07, 2016	1 Year
2.	Test Soft	EM TEST	lec. control	N/A	N/A	N/A

FOR INJECTED CURRENTS IMMUNITY MEASUREMENT

(Bureau Veritas Shenzhen Co., Ltd., Dongguan Branch)

Item	Equipment	Manufacturer	Model No.	Serial No.	Last Cal.	Cal. Interval
1.	Signal Generator	HP	8648A	3426A01263	Oct.18, 2016	1 Year
2.	CDN	Luthi	L-801M2/M3	2015	Oct.18, 2016	1 Year
3.	CDN(AUX)	TESEQ	CDN M016	27452	Oct.18, 2016	1 Year
4.	6dB 50Watt Attenuator	Huber+Suhner	5906.17.0005	303688	Oct.18, 2016	1 Year
5.	Signal Amplifier	HAEFELY	PAMP250	149594	Oct.18, 2016	1 Year
6.	Electromagnetic Injection Clamp	Luthi	EM101	35640	Oct.18, 2016	1 Year
7.	C/S Test System	HAEFELY	WinPAMP	NSEMC002	Oct.18, 2016	1 Year

FOR VOLTAGE DIPS AND INTERRUPTIONS MEASUREMENT

Item	Equipment	Manufacturer	Model No.	Serial No.	Last Cal.	Cal. Interval
1.	Dips Tester	EM TEST	UCS500N	V1104108683	Mar. 07, 2016	1 Year
2.	Test Soft	EM TEST	lec.control	N/A	N/A	N/A
3.	Dips Modulator	EM TEST	V4780S2	0111-11	Mar. 07, 2016	1 Year

APPENDIX 1 PHOTOGRPHS OF TEST SETUP

LINE CONDUCTED EMISSION TEST



RADIATED EMISSION TEST



POWER HARMONIC & VOLTAGE FLUCTUATION / FLICKER TEST



ELECTROSTATIC DISCHARGE TEST



RADIATED ELECTROMAGNETIC FIELD TEST

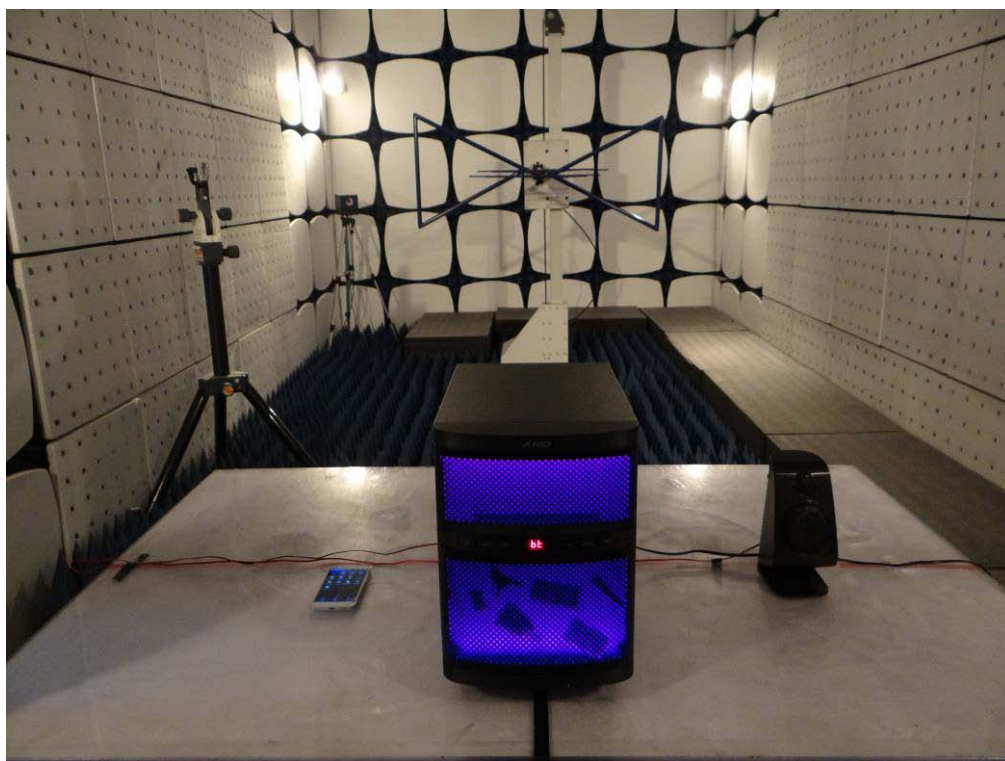

ELECTRICAL FAST TRANSIENTS/BURST/ SURGE/ VOLTAGE DIPS TEST



RADIO FREQUENCY COMMON MODE TEST



General Appearance of the EUT













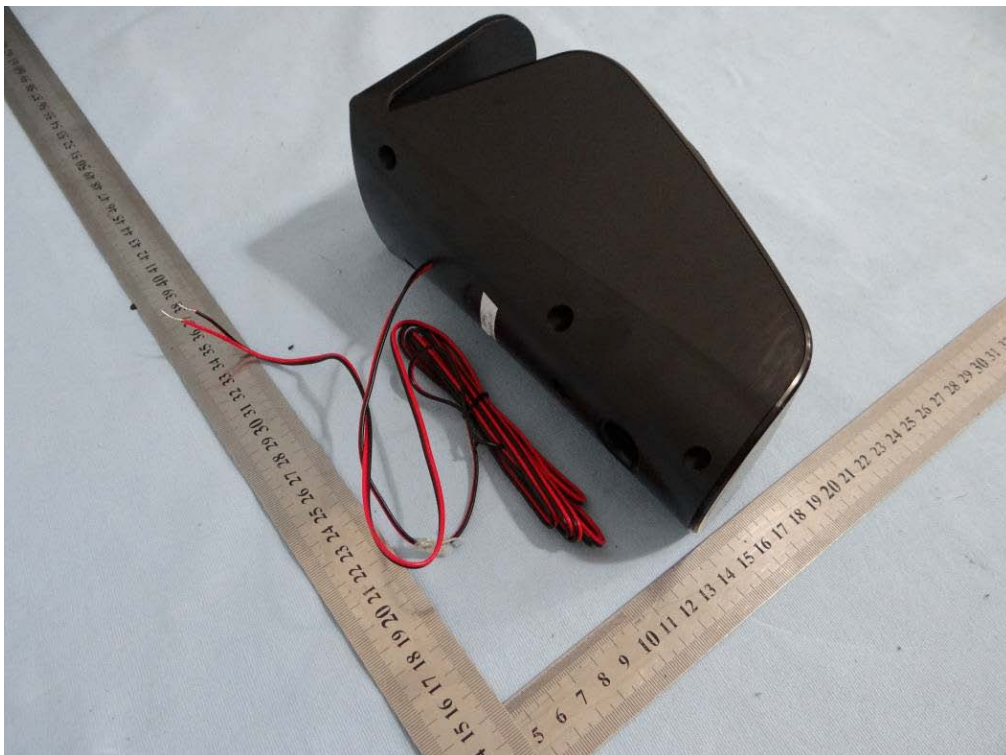

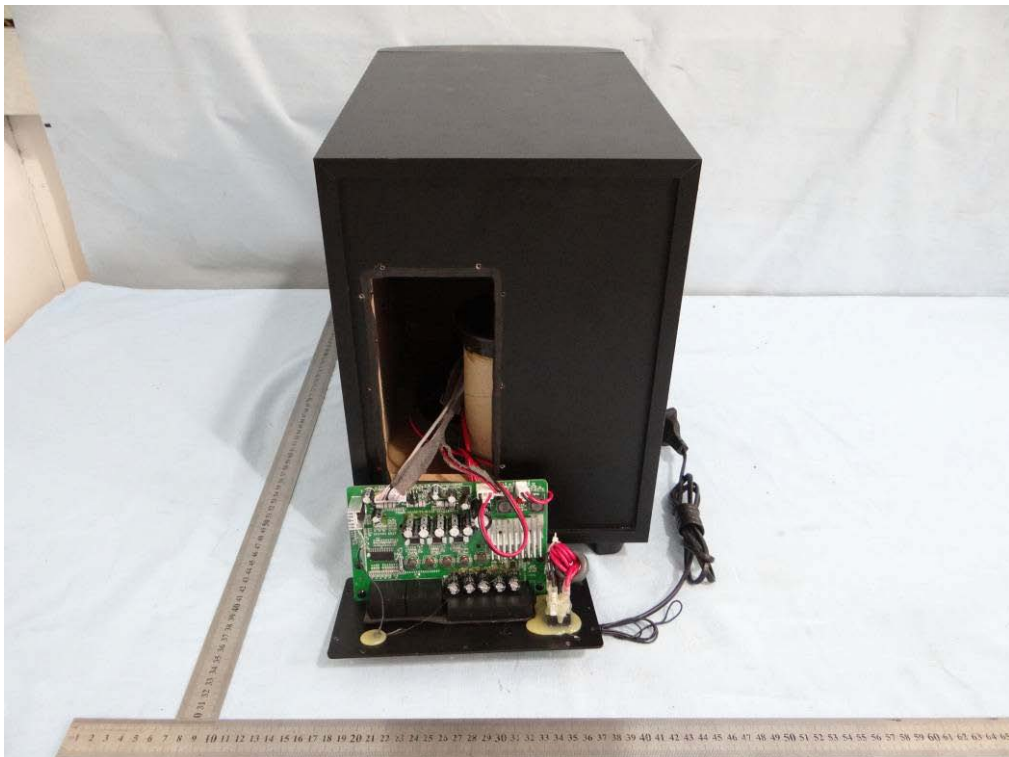

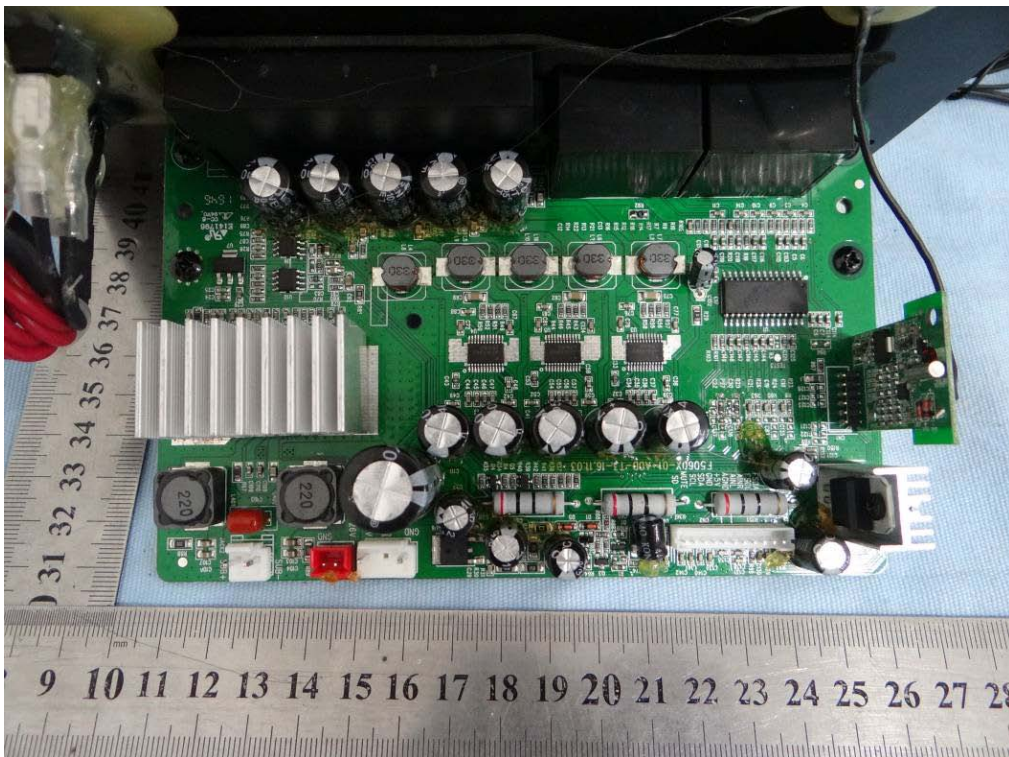
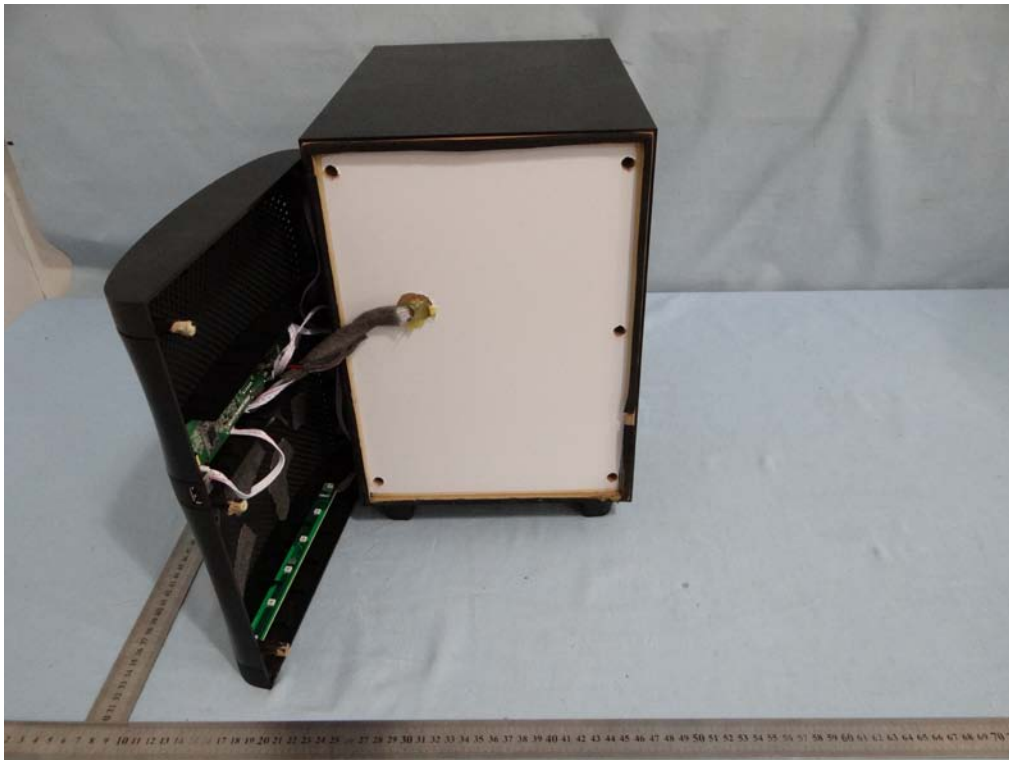

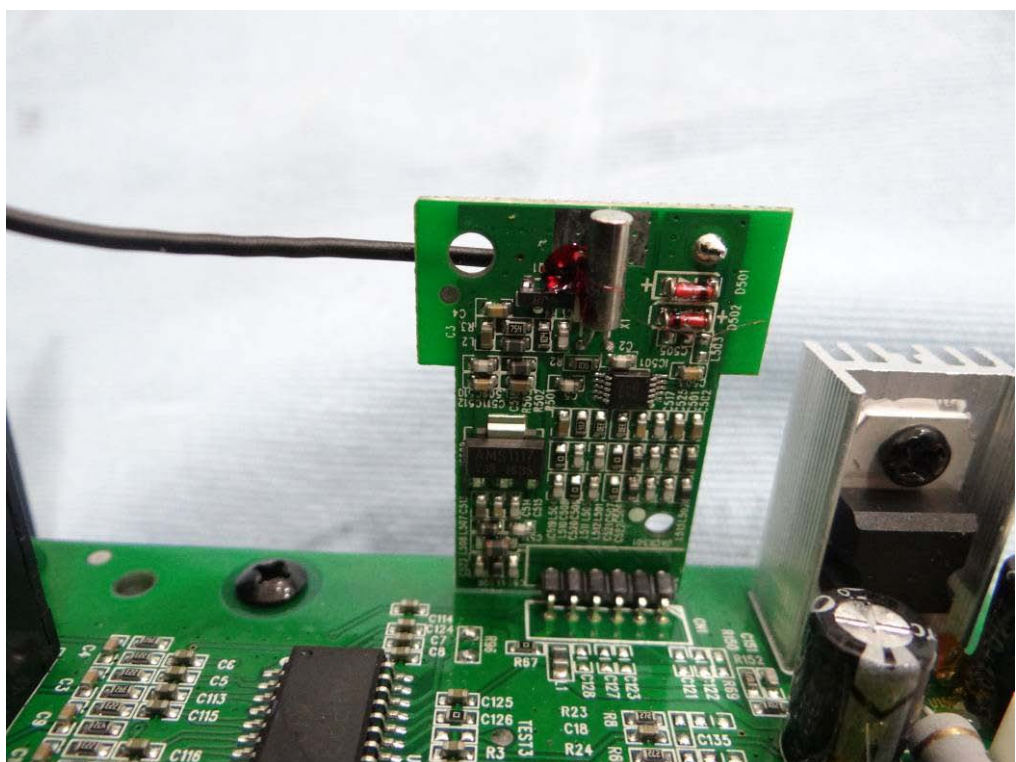
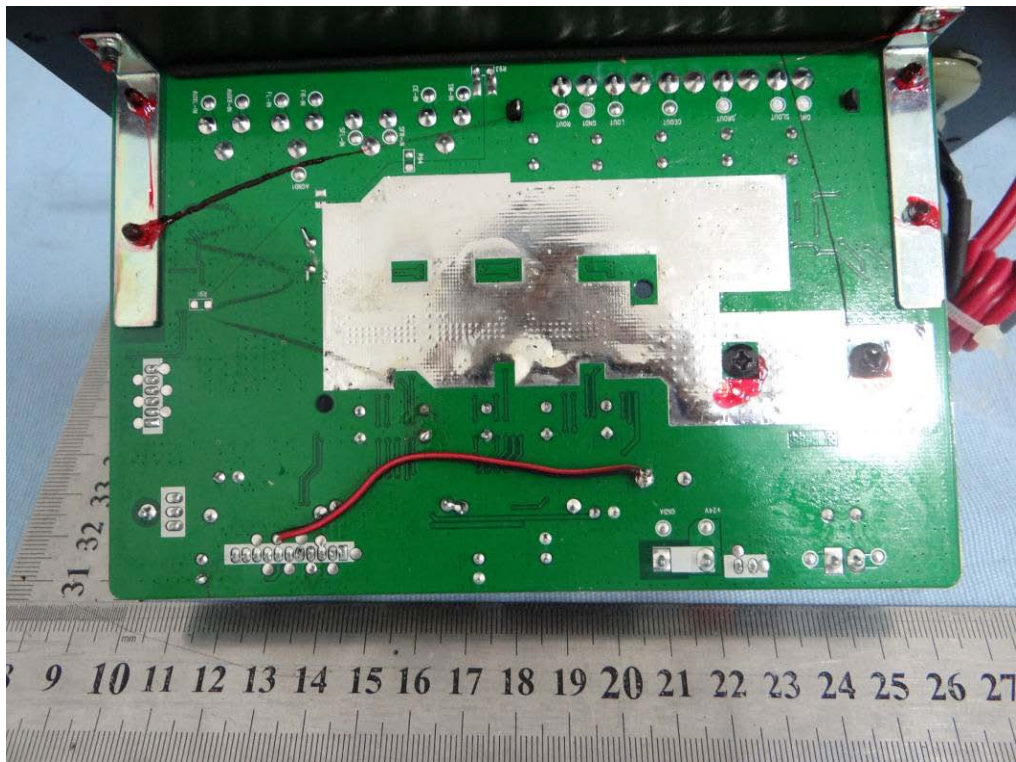

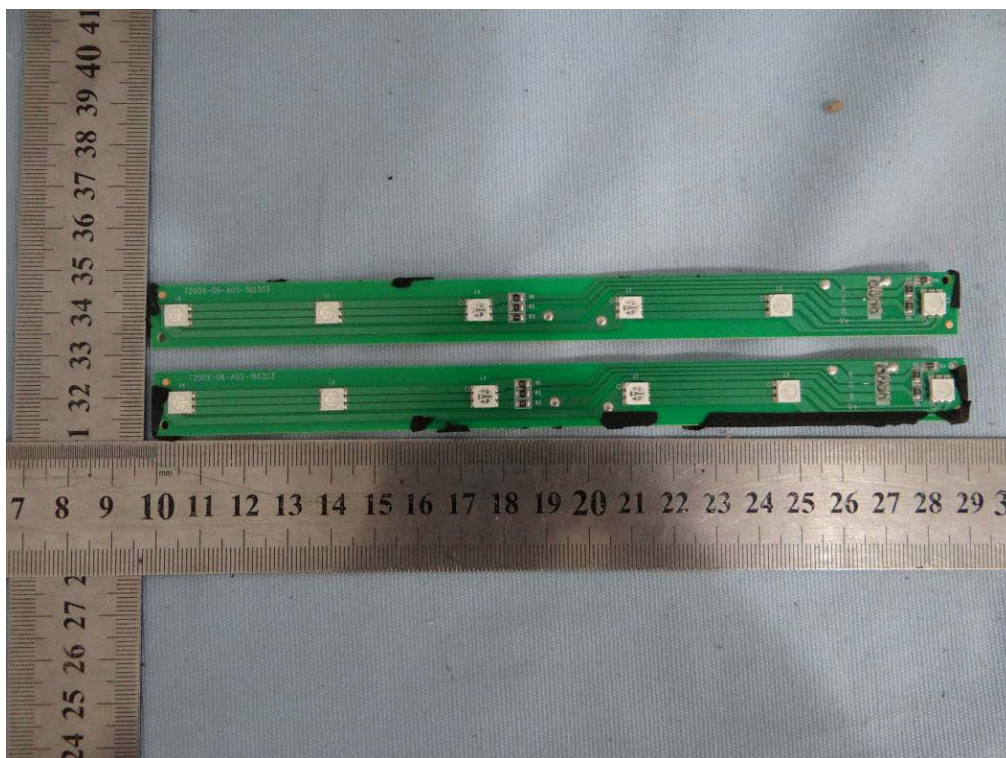
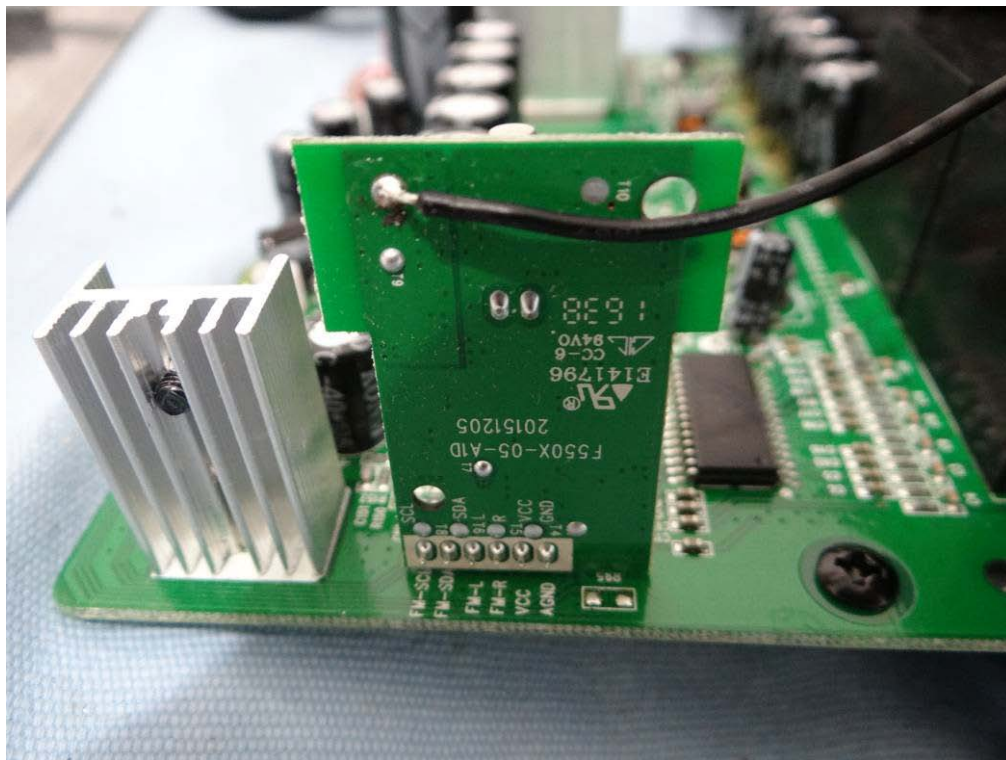

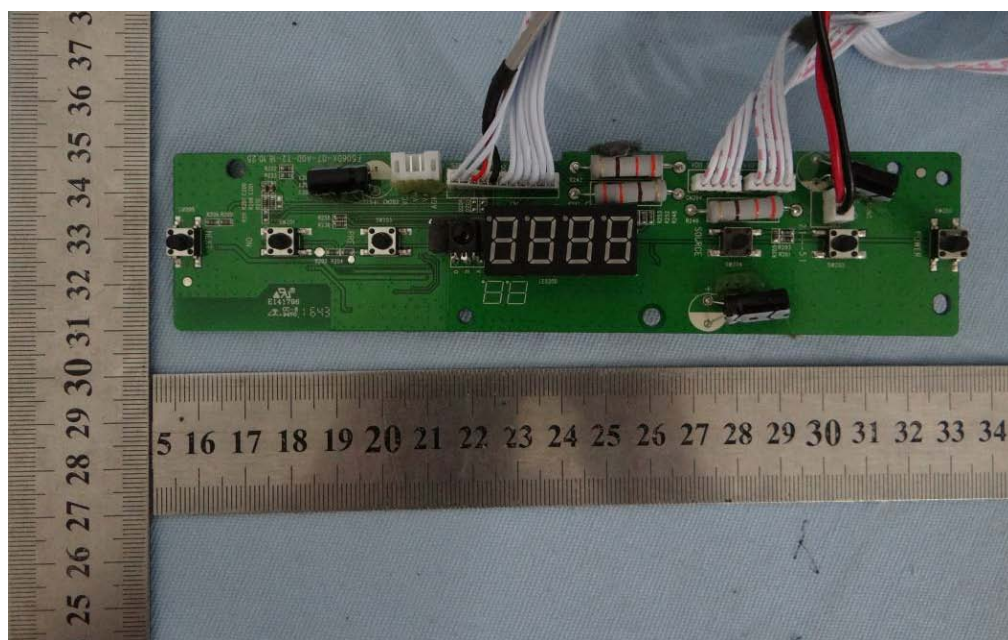
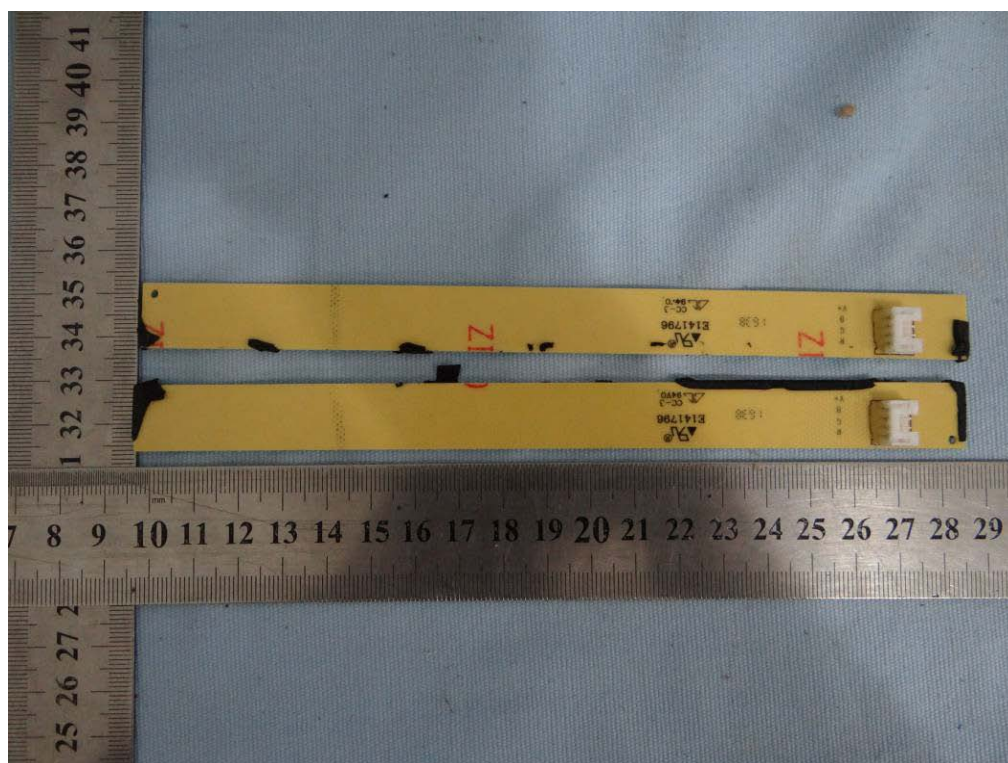

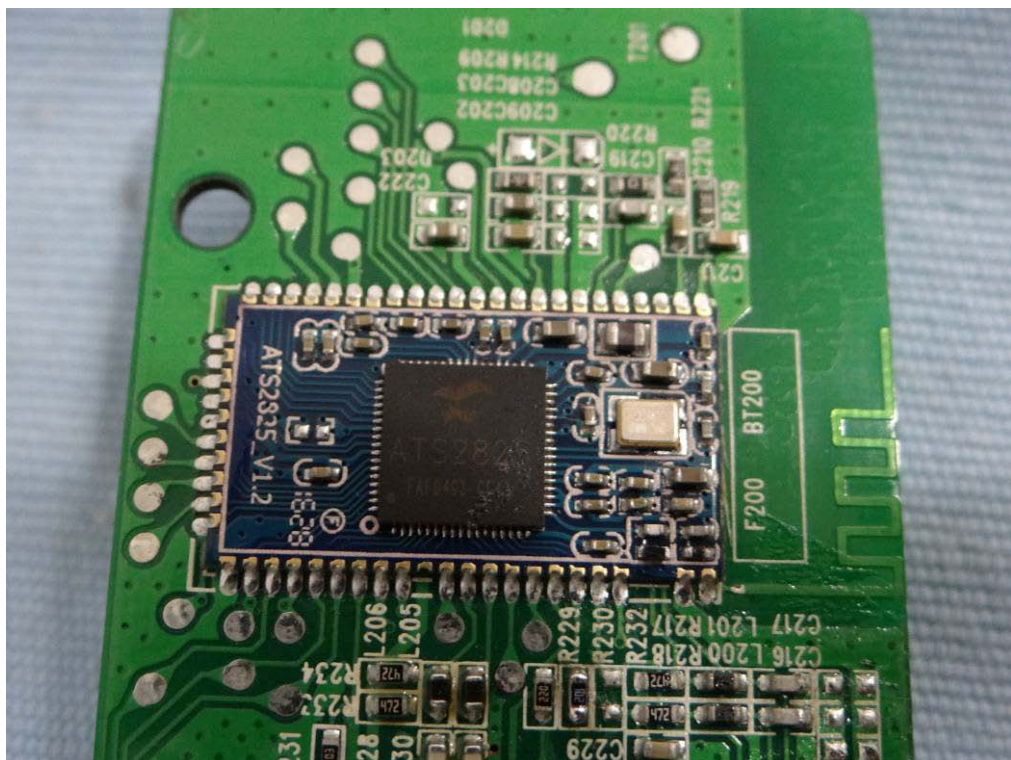
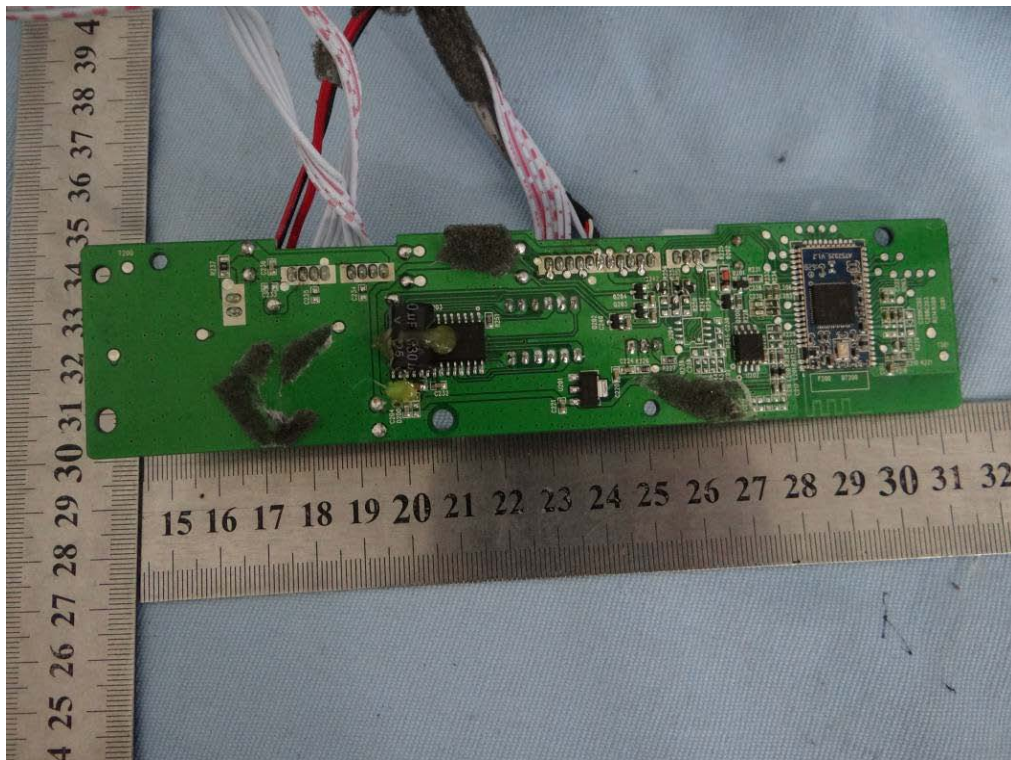

---End---