



RADIO TEST REPORT-BT

ETSI EN 300 328 V2.2.2 (2019-07)

Product : Computer Multimedia Speaker

Trade Mark : F&D

Model Name : R23BT

Family Model : R20BT, R24BT

Report No. : S20071700203002

Prepared for

SHENZHEN FENDA TECHNOLOGY CO., LTD.

Fenda Hi-Tech Park, Zhoushi Road, Shiyao Town, Baoan District,
Shenzhen City, Guangdong, China

Prepared by

Shenzhen NTEK Testing Technology Co., Ltd.

1/F, Building E, Fenda Science Park, Sanwei Community, Xixiang Street
Bao'an District, Shenzhen 518126 P.R. China

Tel.: +86-755-6115 6588 Fax.: +86-755-6115 6599

Website: <http://www.ntek.org.cn>

TEST RESULT CERTIFICATION

Applicant's name : SHENZHEN FENDA TECHNOLOGY CO., LTD.
Address : Fenda Hi-Tech Park, Zhoushi Road, Shiyao Town, Baoan District,
Shenzhen City, Guangdong, China
Manufacturer's Name : SHENZHEN FENDA TECHNOLOGY CO., LTD.
Address : Fenda Hi-Tech Park, Zhoushi Road, Shiyao Town, Baoan District,
Shenzhen City, Guangdong, China

Product description

Product name..... : Computer Multimedia Speaker
Trademark : F&D
Model Name : R23BT
Family Model : R20BT, R24BT

Standards : ETSI EN 300 328 V2.2.2 (2019-07)

This device described above has been tested by NTEK, and the test results show that the equipment under test (EUT) is in compliance with the of article 3.2 of the Directive 2014/53/EU requirements. And it is applicable only to the tested sample identified in the report.

This report shall not be reproduced except in full, without the written approval of NTEK, this document may be altered or revised by NTEK, personnel only, and shall be noted in the revision of the document.

Date of Test

Date (s) of performance of tests 17 Jul. 2020 ~ 14 Aug. 2020

Date of Issue 14 Aug. 2020

Test Result **Pass**

Testing Engineer :

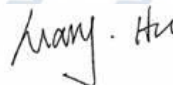

(Mary Hu)

Technical Manager :



(Jason Chen)

Authorized Signatory :



(Alex Li)

Table of Contents

Page

1 . GENERAL INFORMATION	7
1.1 GENERAL DESCRIPTION OF EUT	7
1.2 INFORMATION ABOUT THE EUT	8
1.3 TEST CONDITIONS	13
1.4 TEST CONFIGURATION OF EUT	13
1.5 DESCRIPTION OF TEST CONDITIONS	14
1.6 DESCRIPTION OF SUPPORT UNITS	15
1.7 EQUIPMENTS LIST FOR ALL TEST ITEMS	16
2 . SUMMARY OF TEST RESULTS	17
2.1 TEST FACILITY	18
3 . RF OUTPUT POWER	19
3.1 LIMITS OF RF OUTPUT POWER	19
3.2 TEST PROCEDURE	19
3.3 DEVIATION FROM TEST STANDARD	19
3.4 TEST SETUP	19
3.5 TEST RESULTS	20
4 . ACCUMULATED TRANSMIT TIME, FREQUENCY OCCUPATION AND HOPPING SEQUENCE	21
4.1 LIMITS OF ACCUMULATED TRANSMIT TIME, FREQUENCY OCCUPATION AND HOPPING SEQUENCE	21
4.2 TEST PROCEDURE	21
4.3 DEVIATION FROM TEST STANDARD	21
4.4 TEST SETUP	22
4.5 TEST RESULTS	23
5 . OCCUPIED CHANNEL BANDWIDTH	24
5.1 LIMITS OF OCCUPIED CHANNEL BANDWIDTH	24
5.2 TEST PROCEDURE	24
5.3 DEVIATION FROM TEST STANDARD	25
5.4 TEST SETUP	25
5.5 TEST RESULTS	26
6 . TRANSMITTER UNWANTED EMISSIONS IN THE OUT-OF-BAND DOMAIN	27
6.1 LIMITS OF TRANSMITTER UNWANTED EMISSIONS IN THE OUT-OF-BAND	

Table of Contents

Page

DOMAIN	27
6.2 TEST PROCEDURE	27
6.3 DEVIATION FROM TEST STANDARD	28
6.4 TEST SETUP	28
6.5 TEST RESULTS	29
7 . HOPPING FREQUENCY SEPARATION	30
7.1 LIMITS OF HOPPING FREQUENCY SEPARATION	30
7.2 TEST PROCEDURE	30
7.3 DEVIATION FROM TEST STANDARD	30
7.4 TEST SETUP	31
7.5 TEST RESULTS	32
8 . TRANSMITTER UNWANTED EMISSIONS IN THE SPURIOUS DOMAIN	33
8.1 LIMITS OF TRANSMITTER TRANSMITTER UNWANTED EMISSIONS IN THE SPURIOUS DOMAIN	33
8.2 TEST PROCEDURE	33
8.3 DEVIATION FROM TEST STANDARD	33
8.4 TEST SETUP	34
8.5 TEST RESULTS (Radiated measurement)	35
8.6 TEST RESULTS (Conducted measurement)	36
9 . RECEIVER SPURIOUS EMISSIONS	37
9.1 LIMITS OF RECEIVER SPURIOUS RADIATION	37
9.2 TEST PROCEDURE	37
9.3 DEVIATION FROM TEST STANDARD	37
9.4 TEST SETUP	38
9.5 TEST RESULTS (Radiated measurement)	39
9.6 TEST RESULTS (Conducted measurement)	40
10. RECEIVER BLOCKING	41
10.1 PERFORMANCE CRITERIA	41
10.2 LIMITS OF RECEIVER BLOCKING	41
10.3 TEST PROCEDURE	42
10.4 DEVIATION FROM TEST STANDARD	43
10.5 TEST SETUP	43
10.6 TEST RESULTS	44

Table of Contents	Page
11. TEST RESULTS	45
11.1 Accumulated Transmit Time	45
11.2 Frequency Occupation	48
11.3 One Pulse Dwell Time	51
11.4 RF Output Power	54
11.5 Hopping Frequency Separation	55
11.6 Occupied Channel Bandwidth	58
11.7 Transmitter unwanted emissions in the spurious domain	60
11.8 Receiver spurious emissions	64
11.9 Hopping Sequence	67
11.10 Transmitter unwanted emissions in the out-of-band domain	68
12. PHOTOGRAPHS OF THE TEST CONFIGURATION	69
SPURIOUS EMISSIONS MEASUREMENT PHOTOS	69

Revision History

Report No.	Version	Description	Issued Date
S20071700203002	Rev.01	Initial issue of report	14 Aug. 2020

1. GENERAL INFORMATION

1.1 GENERAL DESCRIPTION OF EUT

Equipment	Computer Multimedia Speaker	
Trade Mark	F&D	
Model Name.	R23BT	
Family Model	R20BT, R24BT	
Model Difference	All the model are the same circuit and RF module, except the exterior and color difference	
Product Description	The EUT is Computer Multimedia Speaker	
	Operation Frequency:	2402-2480 MHz
	Modulatin Type:	GFSK, π/4-DQPSK
	Modulation Technology:	FHSS
	Adaptive/non-adaptive	Adaptive equipment
	Receiver categories	2
	Number Of Channel	79CH
	Antenna Designation:	PCB Antenna
	Antenna Gain(Peak)	3 dBi
	Based on the application, features, or specification exhibited in User's Manual, the EUT is considered as an ITE/Computing Device. More details of EUT technical specification, please refer to the User's Manual.	
Channel List	Refer to below Table	
Adapter	N/A	
Battery	N/A	
Rating	AC 100-240V 50/60Hz 0.3A	
I/O Ports	N/A	
Hardware Version	N/A	
Software Version	N/A	

Note:

1. For a more detailed features description, please refer to the manufacturer's specifications or the User's Manual.

2.

79 channels are provided to BT(GFSK, $\pi/4$ -DQPSK, 8-DPSK)

Channel	Frequency (MHz)
00	2402
01	2403
.....
.....
.....	...
.....
77	2479
78	2480

1.2 INFORMATION ABOUT THE EUT

a) The type of modulation used by the equipment:

- FHSS
- other forms of modulation

b) In case of FHSS modulation:

- In case of non-Adaptive Frequency Hopping equipment:
The number of Hopping Frequencies:
- In case of Adaptive Frequency Hopping Equipment:
The maximum number of Hopping Frequencies: 79
The minimum number of Hopping Frequencies: 79
- The (average) Dwell Time:174.624ms Maximum

c) Adaptive / non-adaptive equipment:

- non-adaptive Equipment
- adaptive Equipment without the possibility to switch to a non-adaptive mode
- adaptive Equipment which can also operate in a non-adaptive mode

d) In case of adaptive equipment:

The maximum Channel Occupancy Time implemented by the equipment:/..... ms

- The equipment has implemented an LBT based DAA mechanism
 - In case of equipment using modulation different from FHSS:
 - The equipment is Frame Based equipment
 - The equipment is Load Based equipment
 - The equipment can switch dynamically between Frame Based and Load Based equipment

The CCA time implemented by the equipment:/.. μ s

- The equipment has implemented a non-LBT based DAA mechanism
- The equipment can operate in more than one adaptive mode

e) In case of non-adaptive Equipment:

The maximum RF Output Power (e.i.r.p.):

The maximum (corresponding) Duty Cycle:

Equipment with dynamic behaviour, that behaviour is described here. (e.g. the different combinations of duty cycle and corresponding power levels to be declared):

f) The worst case operational mode for each of the following tests:

- RF Output Power
GFSK
- Power Spectral Density
N/A
- Duty cycle, Tx-Sequence, Tx-gap
N/A
- Accumulated Transmit time, Frequency Occupation & Hopping Sequence (only for FHSS equipment)
□/4-DQPSK
- Hopping Frequency Separation (only for FHSS equipment)
GFSK
- Medium Utilization
N/A
- Adaptivity
N/A
- Receiver Blocking
GFSK
- Nominal Channel Bandwidth
□/4-DQPSK
- Transmitter unwanted emissions in the OOB domain
□/4-DQPSK
- Transmitter unwanted emissions in the spurious domain
□/4-DQPSK
- Receiver spurious emissions
GFSK

g) The different transmit operating modes (tick all that apply):

- Operating mode 1: Single Antenna Equipment
- Equipment with only one antenna
- Equipment with two diversity antennas but only one antenna active at any moment in time
- Smart Antenna Systems with two or more antennas, but operating in a (legacy) mode where only one antenna is used (e.g. IEEE 802.11™ [i.3] legacy mode in smart antenna systems)
- Operating mode 2: Smart Antenna Systems - Multiple Antennas without beam forming
- Single spatial stream / Standard throughput / (e.g. IEEE 802.11™ [i.3] legacy mode)
- High Throughput (> 1 spatial stream) using Nominal Channel Bandwidth 1

- High Throughput (> 1 spatial stream) using Nominal Channel Bandwidth 2

NOTE 1: Add more lines if more channel bandwidths are supported.

- Operating mode 3: Smart Antenna Systems - Multiple Antennas with beam forming
- Single spatial stream / Standard throughput (e.g. IEEE 802.11™ [i.3] legacy mode)
- High Throughput (> 1 spatial stream) using Nominal Channel Bandwidth 1
- High Throughput (> 1 spatial stream) using Nominal Channel Bandwidth 2

NOTE 2: Add more lines if more channel bandwidths are supported.

h) In case of Smart Antenna Systems:

- The number of Receive chains:
- The number of Transmit chains:
 - symmetrical power distribution
 - asymmetrical power distribution

In case of beam forming, the maximum (additional) beam forming gain: dB

NOTE: The additional beam forming gain does not include the basic gain of a single antenna.

i) Operating Frequency Range(s) of the equipment:

- Operating Frequency Range 1: 2402 MHz to 2480 MHz
 - Operating Frequency Range 2: MHz to MHz
- NOTE: Add more lines if more Frequency Ranges are supported.

j) Nominal Channel Bandwidth(s):

- Nominal Channel Bandwidth 1: 1.201MHz
 - Nominal Channel Bandwidth 2:/..... MHz
- NOTE: Add more lines if more channel bandwidths are supported.

k) Type of Equipment (stand-alone, combined, plug-in radio device, etc.):

- Stand-alone
- Combined Equipment (Equipment where the radio part is fully integrated within another type of equipment)
- Plug-in radio device (Equipment intended for a variety of host systems)
- Other

l) The normal and the extreme operating conditions that apply to the equipment:

Normal operating conditions (if applicable):

Operating temperature: 15°C~35°C
 Other (please specify if applicable):

Extreme operating conditions:

Operating temperature range: Minimum: -10°C Maximum 40°C
 Other (please specify if applicable): Minimum: Maximum

Details provided are for the:

- stand-alone equipment
- combined (or host) equipment
- test jig

m) The intended combination(s) of the radio equipment power settings and one or more antenna assemblies and their corresponding e.i.r.p. levels:

- Antenna Type: PCB Antenna

Integral Antenna (information to be provided in case of conducted measurements)

Antenna Gain: 3 dBi

If applicable, additional beamforming gain (excluding basic antenna gain):/..... dB

- Temporary RF connector provided
- No temporary RF connector provided
- Dedicated Antennas (equipment with antenna connector)
- Single power level with corresponding antenna(s)
- Multiple power settings and corresponding antenna(s)

Number of different Power Levels:

Power Level 1: dBm

Power Level 2: dBm

Power Level 3: dBm

NOTE 1: Add more lines in case the equipment has more power levels.

NOTE 2: These power levels are conducted power levels (at antenna connector).

- For each of the Power Levels, provide the intended antenna assemblies, their corresponding gains (G) and the resulting e.i.r.p. levels also taking into account the beamforming gain (Y) if applicable

Power Level 1: dBm

Number of antenna assemblies provided for this power level:

Assembly #	Gain (dBi)	e.i.r.p. (dBm)	Part number or model name
1	3	5.04	
2			
3			

NOTE 3: Add more rows in case more antenna assemblies are supported for this power level.

Power Level 2: dBm

Number of antenna assemblies provided for this power level:

Assembly #	Gain (dBi)	e.i.r.p. (dBm)	Part number or model name
1			
2			
3			

NOTE 4: Add more rows in case more antenna assemblies are supported for this power level.

Power Level 3: dBm

Number of antenna assemblies provided for this power level:

Assembly #	Gain (dBi)	e.i.r.p. (dBm)	Part number or model name
1			
2			
3			

NOTE 5: Add more rows in case more antenna assemblies are supported for this power level.

n) The nominal voltages of the stand-alone radio equipment or the nominal voltages of the combined (host) equipment or test jig in case of plug-in devices:

Details provided are for the:

- stand-alone equipment
- combined (or host) equipment
- test jig

Supply Voltage AC mains State AC voltage: AC 230V/50Hz
 DC State DC voltage:

In case of DC, indicate the type of power source

- Internal Power Supply
- External Power Supply or AC/DC adapter:
- Battery:
- Other:

o) Describe the test modes available which can facilitate testing:

p) The equipment type (e.g. Bluetooth®, IEEE 802.11™ [i.3], IEEE 802.15.4™ [i.4], proprietary, etc.):

Bluetooth®

q) If applicable, the statistical analysis referred to in clause 5.4.1 q)

(to be provided as separate attachment)

r) If applicable, the statistical analysis referred to in clause 5.4.1 r)

(to be provided as separate attachment)

s) Geo-location capability supported by the equipment:

- Yes
- The geographical location determined by the equipment as defined in clause 4.3.1.13.2 or clause 4.3.2.12.2 is not accessible to the user
- No

t) Describe the minimum performance criteria that apply to the equipment (see clause 4.3.1.12.3 or clause 4.3.2.11.3):

GFSK=0.77%

1.3 TEST CONDITIONS

	Normal Test Conditions	Extreme Test Conditions
Temperature	15°C - 35°C	-10°C ~ 40°C Note: (1)
Relative Humidity	20% - 75%	N/A
Supply Voltage	AC 230V/50Hz	/

Note:

(1) The HT 40°C and LT -10°C was declared by manufacturer, The EUT couldn't be operate normally with higher or lower temperature.

(2) The measurements are performed at the highest, middle, lowest available channels.

1.4 TEST CONFIGURATION OF EUT

Modulation Used For Conformance Testing		
Bluetooth mode	Data rate	Modulation type
BR	1Mbps	GFSK
EDR	2Mbps	π/4-DQPSK
EDR	3Mbps	8-DPSK

Test Channel Frequencies Configuration		
Test Channel	EUT Channel	Test Frequency (MHz)
Lowest	CH00	2402
Middle	CH39	2441
Highest	CH78	2480

1.5 DESCRIPTION OF TEST CONDITIONS

E-1
EUT

1.6 DESCRIPTION OF SUPPORT UNITS

The EUT has been tested as an independent unit together with other necessary accessories or support units. The following support units or accessories were used to form a representative test configuration during the tests.

Item	Equipment	Brand	Model/Type No.	Series No.	Note
E-1	Computer Multimedia Speaker	F&D	R23BT	N/A	EUT

Item	Shielded Type	Ferrite Core	Length	Note

Note:

- (1) The support equipment was authorized by Declaration of Confirmation.
- (2) For detachable type I/O cable should be specified the length in cm in 『Length』 column.

1.7 EQUIPMENTS LIST FOR ALL TEST ITEMS

EQUIPMENT TYPE	Manufacturer	Type No.	Serial No.	Last calibration	Calibrated until	Calibration period
EMI Test Receiver	R&S	ESPI7	101318	2020.05.11	2021.05.10	1 year
Bilog Antenna	TESEQ	CBL6111D	31216	2020.04.11	2021.04.10	1 year
Turn Table	EM	SC100_1	60531	N/A	N/A	N/A
Antnna Mast	EM	SC100	N/A	N/A	N/A	N/A
Horn Antenna	EM	EM-AH-10180	2011071402	2020.04.11	2021.04.10	1 year
Horn Ant	Schwarzbeck	BBHA 9170	9170-181	2019.12.10	2020.12.09	1 year
Test Cable (30MHz-1GHz)	N/A	R-01	N/A	2018.04.21	2021.04.20	3 year
Test Cable (1-18GHz)	N/A	R-02	N/A	2018.04.21	2021.04.20	3 year
50Ω Coaxial Switch	Anritsu	MP59B	6200983705	2019.05.19	2021.05.18	2 year
Pre-Amplifier	EMC	EMC051835S E	980246	2019.08.06	2020.08.05	1 year
Spectrum Analyzer	Agilent	E4407B	MY45108040	2020.05.11	2021.05.10	1 year
Filter	TRILTHIC	2400MHz	29	2020.04.07	2023.04.06	3 year
Attenuator	Weinschel	33-10-33	AR4010	2020.04.07	2023.04.06	3 year
Attenuator	Weinschel	24-20-34	BP4485	2020.04.07	2023.04.06	3 year
MXA Signal Analyzer	Agilent	N9020A	MY49100060	2020.05.11	2021.05.10	1 year
ESG VETCTOR SIGNAL GENERAROR	Agilent	E4438C	MY45093347	2020.05.11	2021.05.10	1 year
PSG Analog Signal Generator	Agilent	E8257D	MY51110112	2020.05.11	2021.05.10	1 year
Power Splitter	Mini-Circuits/USA	ZN2PD-63-S+	SF025101428	2020.04.07	2023.04.06	3 year
Coupler	Mini-Circuits	ZADC-10-63-S +	SF794101410	2020.04.07	2023.04.06	3 year
Directional Coupler	MCLI/USA	CB11-20	0D2L51502	2018.08.16	2021.08.15	3 year
Attenuator	Agilent	8495B	MY42147029	2020.04.13	2023.4.12	3 year
Power Meter	DARE	RPR3006W	15I00041SNO 84	2020.05.11	2021.05.10	1 year
MXG Vector Signal Generator	Agilent	N5182A	MY47070317	2020.05.13	2021.05.12	1 year
Wideband Radio Communication Tester Specifications	R&S	CMW500	148500	2020.05.13	2021.05.12	1 year
temporary antenna connector (Note)	NTS	R001	N/A	N/A	N/A	N/A

2. SUMMARY OF TEST RESULTS

The EUT has been tested according to the following specifications:

ETSI EN 300 328 V2.2.2 (2019-07)		
Clause	Test Item	Results
TRANSMITTER PARAMETERS		
4.3.1.2	RF Output Power	Pass
4.3.1.3	Duty cycle, Tx-Sequence, Tx-gap	Not Applicable (See Note 1/2)
4.3.1.4	Accumulated Transmit Time, Frequency Occupation and Hopping Sequence	Pass
4.3.1.5	Hopping Frequency Separation	Pass
4.3.1.6	Medium Utilization (MU) factor	Not Applicable (See Note 1/2)
4.3.1.7	Adaptivity	Not Applicable (See Note 1)
4.3.1.8	Occupied Channel Bandwidth	Pass
4.3.1.9	Transmitter unwanted emission in the OOB domain	Pass
4.3.1.10	Transmitter unwanted emissions in the spurious domain	Pass
RECEIVER PARAMETERS		
4.3.1.11	Receiver Spurious Emissions	Pass
4.3.1.12	Receiver Blocking	Pass

Note:

1. These requirements do not apply for equipment with a maximum declared RF output power of less than 10 dBm EIRP or for equipment when operating in a mode where the RF output power is less than 10 dBm EIRP.
2. These requirements apply to non-adaptive frequency hopping equipment or to adaptive frequency hopping equipment operating in a non-adaptive mode

2.1 TEST FACILITY

Shenzhen NTEK Testing Technology Co., Ltd.

Add. : 1/F, Building E, Fenda Science Park, Sanwei Community, Xixiang Street, Bao'an District, Shenzhen 518126 P.R. China

FCC Registered No.: 463705 IC Registered No.:9270A-1

CNAS Registration No.:L5516

2.2 MAXIMUM MEASUREMENT UNCERTAINTY

For the test methods, according to ETSI EN 300 328 standard, the measurement uncertainty figures shall be calculated in accordance with ETR 100 028-1[4] and shall correspond to an expansion factor(coverage factor) $k=1.96$ or $k=2$ (which provide confidence levels of respectively **95 %** and **95.45 %** in the case where the distributions characterizing the actual measurement uncertainties are normal (Gaussian)).

Maximum measurement uncertainty

No.	Item	Uncertainty
1	Occupied Channel Bandwidth	$\pm 5\%$
2	RF output Power,conducted	$\pm 1.5\text{dB}$
3	Power Spectral Density, conducted	$\pm 3\text{dB}$
4	Unwanted emissions, conducted	$\pm 3\text{dB}$
5	All emissions,radiated	$\pm 6\text{dB}$
6	Temperature	$\pm 3^{\circ}\text{C}$
7	Humidity	$\pm 3\%$
9	Time	$\pm 5\%$

TRANSMITTER PARAMETERS

3. RF OUTPUT POWER

3.1 LIMITS OF RF OUTPUT POWER

Refer to chapter 4.3.1.2.3 of ETSI EN 300 328 V2.2.2 (2019-07)

RF OUTPUT POWER	
Condition	Limit
<input type="checkbox"/> Non-adaptive frequency hopping systems	Equal to or less than the value declared by the supplier. This declared value shall be equal to or less than 20 dBm.
<input checked="" type="checkbox"/> Adaptive frequency hopping systems	equal to or less than 20 dBm.

3.2 TEST PROCEDURE

Refer to chapter 5.4.2.2 of ETSI EN 300 328 V2.2.2 (2019-07)

Measurement	
<input checked="" type="checkbox"/> Conducted measurement	<input type="checkbox"/> Radiated measurement

3.3 DEVIATION FROM TEST STANDARD

No deviation

3.4 TEST SETUP

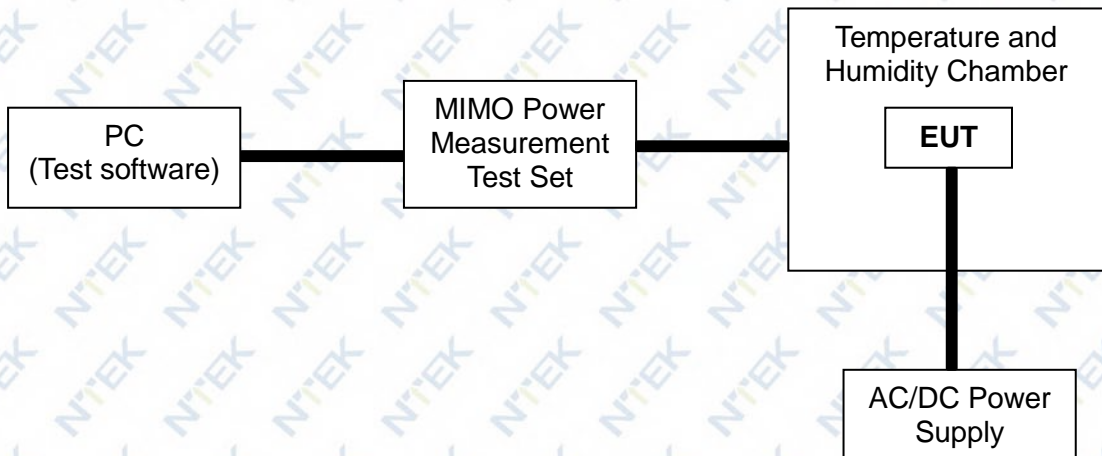

3.5 TEST RESULTS

EUT :	Computer Multimedia Speaker	Model Name :	R23BT
Temperature :	20°C	Relative Humidity :	55 %
Pressure :	1012 hPa	Test Voltage :	AC 230V/50Hz (Normal)
Test Mode :	BT-GFSK/π/4-DQPSK /8-DPSK		

Test data reference attachment

4. ACCUMULATED TRANSMIT TIME, FREQUENCY OCCUPATION AND HOPPING SEQUENCE

4.1 LIMITS OF ACCUMULATED TRANSMIT TIME, FREQUENCY OCCUPATION AND HOPPING SEQUENCE

Refer to chapter 4.3.1.4.3 of ETSI EN 300 328 V2.2.2 (2019-07)

Accumulated Transmit Time	
Condition	Limit
<input type="checkbox"/> Non-adaptive frequency hopping systems	≤ 15 ms[15 ms * the minimum number of hopping frequencies (N)]
<input checked="" type="checkbox"/> Adaptive frequency hopping systems	≤ 400 ms in [400 ms * the minimum number of hopping frequencies (N)]
MINIMUM FREQUENCY OCCUPATION TIME	
Condition	Limit
<input type="checkbox"/> Non-adaptive frequency hopping systems	Each hopping frequency of the hopping sequence shall be occupied at least once within a period not exceeding four times the product of the dwell time and the number of hopping frequencies in use.
<input checked="" type="checkbox"/> Adaptive frequency hopping systems	
HOPPING SEQUENCE (S)	
Condition	Limit
<input type="checkbox"/> Non-adaptive frequency hopping systems	≥15 hopping frequencies or 15/minimum
<input checked="" type="checkbox"/> Adaptive frequency hopping systems	Operating over a minimum of 70% of the Operating in the band 2.4 GHz to 2.4835 GHz
	≥15 hopping frequencies or 15/minimum

4.2 TEST PROCEDURE

Refer to chapter 5.4.4 of ETSI EN 300 328 V2.2.2 (2019-07)

Measurement	
<input checked="" type="checkbox"/> Conducted measurement	<input type="checkbox"/> Radiated measurement

4.3 DEVIATION FROM TEST STANDARD

No deviation

4.4 TEST SETUP



The measurements only were performed at normal test conditions. The equipment was configured to operate at its maximum Dwell time and maximum Duty Cycle. The measurement was performed on a minimum of 2 hopping frequencies chosen arbitrary from the actual hopping sequence. In case of conducted measurements the transmitter shall be connected to the measuring equipment via a suitable attenuator. Controlling software (Button Function) has been activated to set the EUT on specific status.

4.5 TEST RESULTS

EUT :	Computer Multimedia Speaker	Model Name :	R23BT
Temperature :	26°C	Relative Humidity	60 %
Pressure :	1012 hPa	Test Voltage :	AC 230V/50Hz
Test Mode :	BT-GFSK-Hopping Mode		

Test data reference attachment

5. OCCUPIED CHANNEL BANDWIDTH

5.1 LIMITS OF OCCUPIED CHANNEL BANDWIDTH

Refer to chapter 4.3.1.8.3 of ETSI EN 300 328 V2.2.2 (2019-07)

OCCUPIED CHANNEL BANDWIDTH		
Condition		Limit
All types of equipment		Shall fall completely within the band 2400 to 2483.5 MHz
Additional requirement	For non-adaptive using wide band modulations other than FHSS system and EIRP >10 dBm	Less than 20 MHz
	For non-adaptive frequency hopping system and EIRP >10 dBm	Less than 5 MHz

5.2 TEST PROCEDURE

Refer to chapter 5.4.7.2 of ETSI EN 300 328 V2.2.2 (2019-07)

Measurement	
<input checked="" type="checkbox"/> Conducted measurement	<input type="checkbox"/> Radiated measurement

The setting of the Spectrum Analyzer

Center Frequency	The centre frequency of the channel under test
Frequency Span	2 × Nominal Channel Bandwidth
Detector	RMS
RBW	~ 1 % of the span without going below 1 %
VBW	3 × RBW
Trace	Max hold
Sweep time	1s

5.3 DEVIATION FROM TEST STANDARD

No deviation

5.4 TEST SETUP



These measurements only were performed at normal test conditions. The measurement shall be performed only on the lowest and the highest frequency within the stdest frequency range. Using software to force the EUT to hop or transmit on a single Hopping frequency. In case of conducted measurements the transmitter shall be connected to the measuring equipment via a suitable attenuator. Controlling software (Button Function) has been activated to set the EUT on specific status.

5.5 TEST RESULTS

EUT :	Computer Multimedia Speaker	Model Name :	R23BT
Temperature :	26°C	Relative Humidity :	60 %
Pressure :	1012 hPa	Test Voltage :	AC 230V/50Hz
Test Mode :	BT-GFSK(CH00/CH78)		

Test data reference attachment

6. TRANSMITTER UNWANTED EMISSIONS IN THE OUT-OF-BAND DOMAIN

6.1 LIMITS OF TRANSMITTER UNWANTED EMISSIONS IN THE OUT-OF-BAND DOMAIN

Refer to chapter 4.3.1.9.3 of ETSI EN 300 328 V2.2.2 (2019-07)

TRANSMITTER UNWANTED EMISSIONS IN THE OUT-OF-BAND DOMAIN	
Condition	Limit
Under all test conditions	The transmitter unwanted emissions in the out-of-band domain but outside the allocated band, shall not exceed the values provided by the mask in below figure.

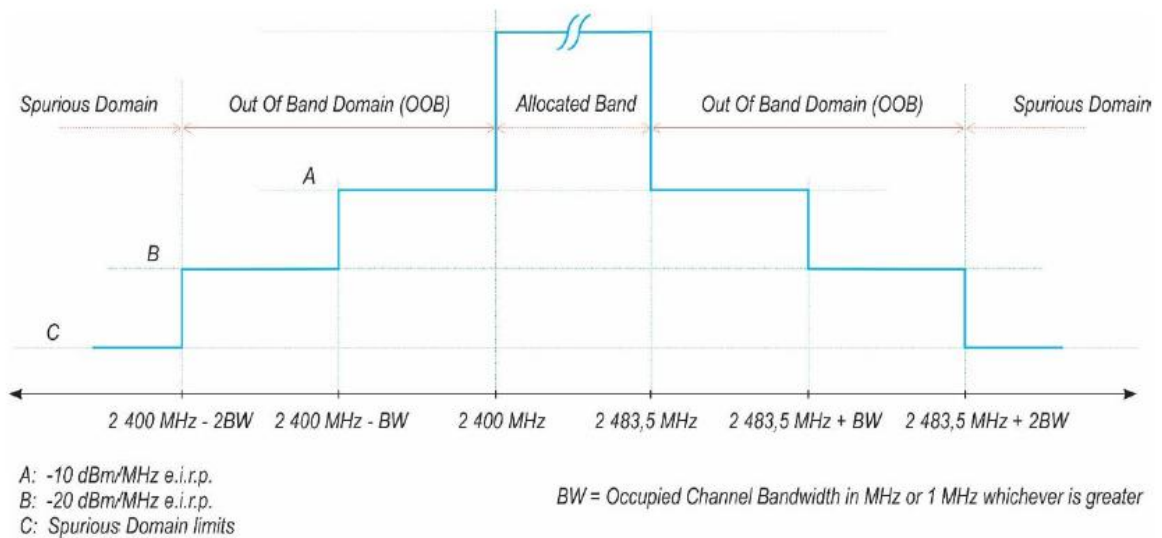

Figure 1: Transmit mask

6.2 TEST PROCEDURE

Refer to chapter 5.4.8.2 of ETSI EN 300 328 V2.2.2 (2019-07)

Measurement	
<input checked="" type="checkbox"/> Conducted measurement	<input type="checkbox"/> Radiated measurement

The setting of the Spectrum Analyzer

Span	0Hz
Filter Mode	Channel Filter
Trace Mode	Clear/Write
Trigger Mode	Video Trigger
Detector	RMS
Sweep Point / Sweep Mode	5000 / Continuous
RBW / VBW	1MHz / 3MHz

6.3 DEVIATION FROM TEST STANDARD

No deviation

6.4 TEST SETUP

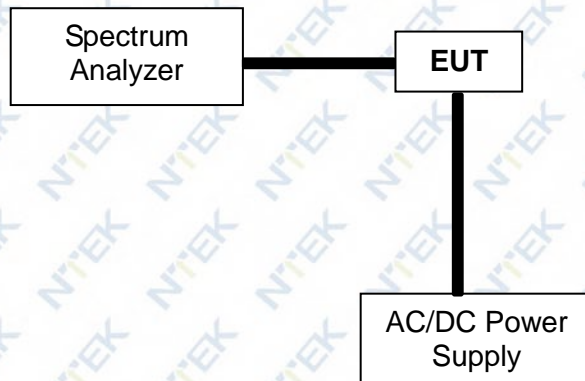

According to the EN 300328 V2.2.2 clause 5.4.8.1: These measurements shall only be performed at normal test conditions. For equipment using FHSS modulation, the measurements shall be performed during normal operation (hopping).

For equipment using wide band modulations other than FHSS, the measurement shall be performed at the lowest and the highest channel on which the equipment can operate. These operating channels shall be recorded.

The equipment shall be configured to operate under its worst case situation with respect to output power.

If the equipment can operate with different Nominal Channel Bandwidths (e.g. 20 MHz and 40 MHz), then each channel bandwidth shall be tested separately.

6.5 TEST RESULTS

EUT :	Computer Multimedia Speaker	Model Name :	R23BT
Temperature :	26°C	Relative Humidity :	60 %
Pressure :	1012 hPa	Test Voltage :	AC 230V/50Hz
Test Mode :	BT-GFSK(CH00/CH78)		

Test data reference attachment

7. HOPPING FREQUENCY SEPARATION

7.1 LIMITS OF HOPPING FREQUENCY SEPARATION

Refer to chapter 4.3.1.5.3 of ETSI EN 300 328 V2.2.2 (2019-07)

HOPPING FREQUENCY SEPARATION	
Condition	Limit
<input type="checkbox"/> Non-adaptive frequency hopping systems	The minimum Hopping Frequency Separation shall be equal to or greater than occupied channel bandwidth of a single hop, with a minimum separation of 100 kHz.
<input checked="" type="checkbox"/> Adaptive frequency hopping systems	The minimum Hopping Frequency Separation shall be 100 kHz.

7.2 TEST PROCEDURE

Refer to chapter 5.4.5.2 of ETSI EN 300 328 V2.2.2 (2019-07)

Measurement	
<input checked="" type="checkbox"/> Conducted measurement	<input type="checkbox"/> Radiated measurement

The setting of the Spectrum Analyzer

Center Frequency	Centre of the two adjacent hopping frequencies
Frequency Span	Sufficient to see the complete power envelope of both hopping frequencies
Detector	Max Peak
RBW	~ 1 % of the span
VBW	3 × RBW
Trace	Max hold
Sweep Time	Auto

7.3 DEVIATION FROM TEST STANDARD

No deviation

7.4 TEST SETUP



The measurements were performed at normal test conditions. The measurement was performed on 2 adjacent hopping frequencies. In case of conducted measurements the transmitter shall be connected to the measuring equipment via a suitable attenuator. Controlling software (Button Function) has been activated to set the EUT on specific status.

7.5 TEST RESULTS

EUT :	Computer Multimedia Speaker	Model Name :	R23BT
Temperature :	26°C	Relative Humidity :	60 %
Pressure :	1012 hPa	Test Voltage :	AC 230V/50Hz
Test Mode :	BT (CH00/CH39/CH78)		

Test data reference attachment

Note: 1.The limitation is from OCB of a single hop and this value must greater and equal to 100kHz.
2.The device will never "hop" to its neighbour channel, therefore the "effective" channel separation becomes 2x the "normal" channel separation.

8. TRANSMITTER UNWANTED EMISSIONS IN THE SPURIOUS DOMAIN

8.1 LIMITS OF TRANSMITTER TRANSMITTER UNWANTED EMISSIONS IN THE SPURIOUS DOMAIN

Refer to chapter 4.3.1.10.3 of ETSI EN 300 328 V2.2.2 (2019-07)

TRANSMITTER UNWANTED EMISSIONS IN THE SPURIOUS DOMAIN		
Frequency Range	Maximum Power Limit (E.R.P.(≤1 GHz) E.I.R.P.(> 1 GHz))	Bandwidth
30 MHz to 47 MHz	-36dBm	100 kHz
47 MHz to 74 MHz	-54dBm	100 kHz
74 MHz to 87.5 MHz	-36dBm	100 kHz
87.5 MHz to 118 MHz	-54dBm	100 kHz
118 MHz to 174 MHz	-36dBm	100 kHz
174 MHz to 230 MHz	-54dBm	100 kHz
230 MHz to 470 MHz	-36dBm	100 kHz
470 MHz to 694 MHz	-54dBm	100 kHz
694 MHz to 1 GHz	-36dBm	100 kHz
1 GHz ~ 12.75 GHz	-30dBm	1 MHz

8.2 TEST PROCEDURE

Refer to chapter 5.4.9.2 of ETSI EN 300 328 V2.2.2 (2019-07)

Measurement	
<input checked="" type="checkbox"/> Conducted measurement	<input checked="" type="checkbox"/> Radiated measurement

The setting of the Spectrum Analyzer

RBW	100K(<1GHz) / 1M(>1GHz)
VBW	300K(<1GHz) / 3M(>1GHz)

8.3 DEVIATION FROM TEST STANDARD

No deviation

8.4 TEST SETUP

Radiated measurement:

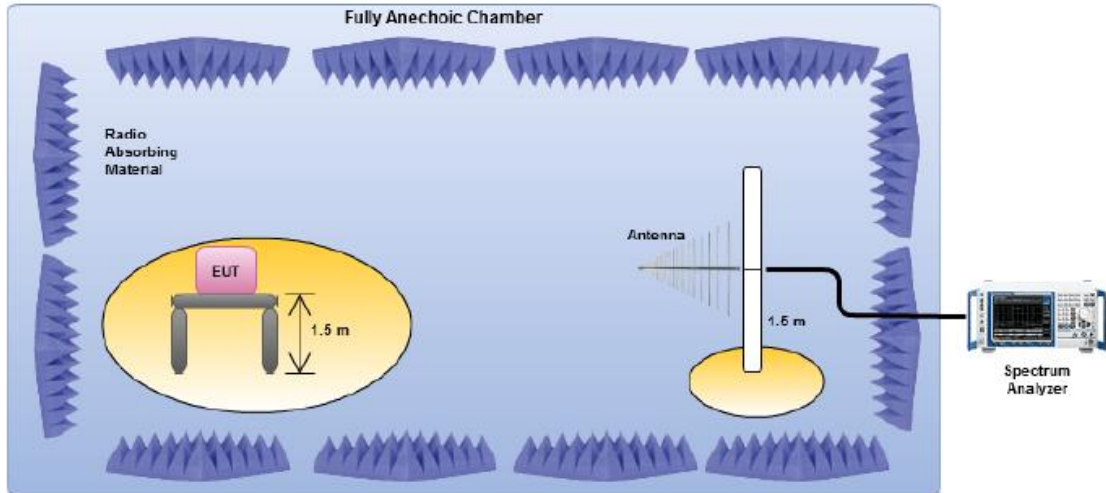

Conducted measurement:



1. For the actual test configuration, please refer to the related Item in this test report (Photographs of the Test Configuration).
2. The measurements were performed when normal hopping was disabled. In this case measurements were performed when operating at the lowest and the highest hopping frequency.
3. The equipment was configured to operate under its worst case situation with respect to output power.
4. The test setup has been constructed as the normal use condition. Controlling software (Button Function) has been activated to set the EUT on specific status.

8.5 TEST RESULTS (Radiated measurement)
 BELOW 1 GHz WORST- CASE DATA (30 MHz ~ 1GHz)

EUT :	Computer Multimedia Speaker	Model Name :	R23BT
Temperature :	24 °C	Relative Humidity	54%
Pressure :	1010 hPa	Test Power :	AC 230V/50Hz
Test Mode :	BT-GFSK(CH00)		

Polar (H/V)	Frequency	Meter Reading	Factor	Emission Level	Limits	Margin	Remark
	(MHz)	(dBm)	(dB)	(dBm)	(dBm)	(dB)	
V	32.065	-76.88	10.77	-66.11	-36	-30.11	peak
V	112.54	-67.48	11.26	-56.22	-54	-2.22	peak
V	225.921	-75.91	11.22	-64.69	-54	-10.69	peak
V	277.555	-76.29	11.19	-65.10	-36	-29.10	peak
V	480.795	-72.85	9.53	-63.32	-54	-9.32	peak
H	42.793	-70.75	10.45	-60.30	-36	-24.30	peak
H	117.18	-69.51	10.20	-59.31	-54	-5.31	peak
H	212.27	-74.59	10.83	-63.76	-54	-9.76	peak
H	338.015	-67.64	11.11	-56.53	-36	-20.53	peak
H	602.229	-70.71	11.03	-59.68	-54	-5.68	peak

Remark:

1. Absolute Level= ReadingLevel+ Factor, Margin= Limit- Absolute Level.
2. All the modes had been tested, but only the worst data recorded in the report.

ABOVE 1 GHz WORST- CASE DATA (1GHz ~ 12.75GHz)

EUT :	Computer Multimedia Speaker	Model Name :	R23BT
Temperature :	24 °C	Relative Humidity	54%
Pressure :	1010 hPa	Test Power :	AC 230V/50Hz
Test Mode :	BT-GFSK (CH00/CH39/CH78)		

Polar (H/V)	Frequency	Meter Reading	Factor	Emission Level	Limits	Margin	Remark
	(MHz)	(dBm)	(dB)	(dBm)	(dBm)	(dB)	
operation frequency:2402							
V	2275.22	-76.62	10.22	-66.40	-30	-36.40	peak
V	5998.375	-71.79	9.68	-62.11	-30	-32.11	peak
V	2189.706	-71.53	10.95	-60.58	-30	-30.58	peak
V	3440.786	-69.99	9.85	-60.14	-30	-30.14	peak
H	2980.135	-74.03	10.50	-63.53	-30	-33.53	peak
H	5687.153	-76.82	11.22	-65.60	-30	-35.60	peak
H	2840.793	-76.49	10.13	-66.36	-30	-36.36	peak
H	4545.492	-67.09	10.38	-56.71	-30	-26.71	peak
operation frequency:2441							
V	2289.864	-71.71	10.17	-61.54	-30	-31.54	peak
V	4164.308	-74.91	10.22	-64.69	-30	-34.69	peak
V	2490.534	-70.73	10.42	-60.31	-30	-30.31	peak
V	4134.397	-71.07	10.79	-60.28	-30	-30.28	peak
H	2312.787	-73.88	9.82	-64.06	-30	-34.06	peak
H	3715.26	-77.88	9.57	-68.31	-30	-38.31	peak
H	2109.836	-68.15	9.66	-58.49	-30	-28.49	peak
H	5706.435	-74	11.33	-62.67	-30	-32.67	peak
operation frequency:2480							
V	2315.318	-68.4	10.13	-58.27	-30	-28.27	peak
V	4151.851	-68.09	9.68	-58.41	-30	-28.41	peak
V	2810.265	-75.17	10.78	-64.39	-30	-34.39	peak
V	5719.82	-71.01	10.82	-60.19	-30	-30.19	peak
H	2213.017	-68.83	11.38	-57.45	-30	-27.45	peak
H	5571.938	-71.38	10.36	-61.02	-30	-31.02	peak
H	2925.883	-72.19	10.60	-61.59	-30	-31.59	peak
H	5379.938	-69.87	10.51	-59.36	-30	-29.36	peak

Remark:

1. Absolute Level= ReadingLevel+ Factor, Margin= Absolute Level – Limit.
2. All the modes had been tested, but only the worst data recorded in the report.

3.6 TEST RESULTS (Conducted measurement)

Test data reference attachment

9. RECEIVER SPURIOUS EMISSIONS

9.1 LIMITS OF RECEIVER SPURIOUS RADIATION

Refer to chapter 4.3.1.11.3 of ETSI EN 300 328 V2.2.2 (2019-07)

RECEIVER SPURIOUS EMISSIONS		
Frequency Range	Maximum Power Limit (E.R.P.(≤ 1 GHz) E.I.R.P.(> 1 GHz))	Measurement Bandwidth
30 MHz ~ 1 GHz	-57dBm	100KHz
1 GHz ~ 12.75 GHz	-47dBm	1MHz

9.2 TEST PROCEDURE

Refer to chapter 5.4.10.2 of ETSI EN 300 328 V2.2.2 (2019-07)

Measurement	
<input checked="" type="checkbox"/> Conducted measurement	<input checked="" type="checkbox"/> Radiated measurement

The setting of the Spectrum Analyzer

RBW	100K(<1GHz) / 1M(>1GHz)
VBW	300K(<1GHz) / 3M(>1GHz)

9.3 DEVIATION FROM TEST STANDARD

No deviation

9.4 TEST SETUP

Radiated measurement:

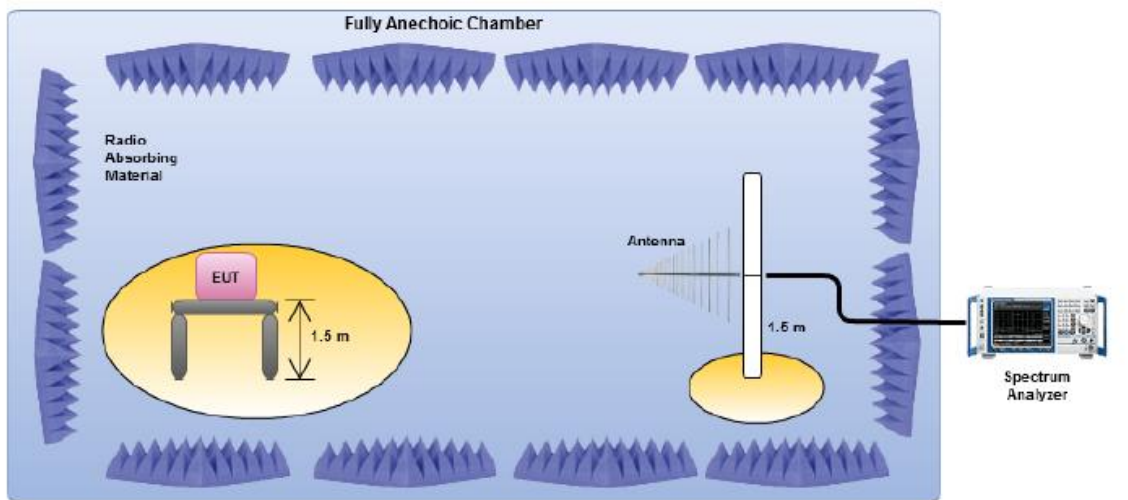

Conducted measurement:

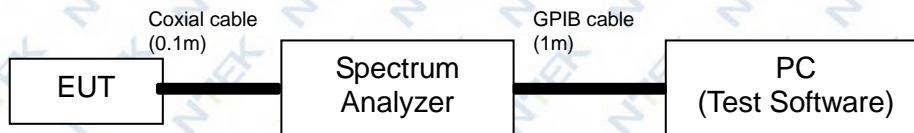

1. For the actual test configuration, please refer to the related Item in this test report (Photographs of the Test Configuration).
2. Testing was performed when the equipment was in a receive-only mode.
3. The measurements were performed when normal hopping was disabled. In this case measurements were performed when operating at the lowest and the highest hopping frequency.
4. The test setup has been constructed as the normal use condition. Controlling software (Button Function) has been activated to set the EUT on specific status.

9.5 TEST RESULTS (Radiated measurement)

RX BELOW 1 GHz WORST- CASE DATA (30 MHz ~ 1GHz)

EUT :	Computer Multimedia Speaker	Model Name :	R23BT
Temperature :	24 °C	Relative Humidity	54%
Pressure :	1010 hPa	Test Power :	AC 230V/50Hz
Test Mode :	BT-GFSK (CH00)		

Polar (H/V)	Frequency	Meter Reading	Factor	Emission Level	Limits	Margin	Remark
	(MHz)	(dBm)	(dB)	(dBm)	(dBm)	(dB)	
V	31.454	-80.97	12.25	-68.72	-57	-11.72	peak
V	91.158	-84.73	16.13	-68.60	-57	-11.60	peak
V	208.726	-78.97	14.05	-64.92	-57	-7.92	peak
V	368.727	-81.34	17.01	-64.33	-57	-7.33	peak
V	614.028	-84.16	15.51	-68.65	-57	-11.65	peak
H	34.281	-80.54	14.62	-65.92	-57	-8.92	peak
H	96.367	-83.47	17.87	-65.60	-57	-8.60	peak
H	199.743	-81.85	16.70	-65.15	-57	-8.15	peak
H	276.573	-78.55	15.79	-62.76	-57	-5.76	peak
H	632.026	-79.54	17.54	-62.00	-57	-5.00	peak

Remark:

1. Absolute Level= ReadingLevel+ Factor, Margin= Absolute Level – Limit.
2. All the modes had been tested, but only the worst data recorded in the report.

RX ABOVE 1 GHz WORST- CASE DATA (1GHz ~ 12.75GHz)

EUT :	Computer Multimedia Speaker	Model Name :	R23BT
Temperature :	24 °C	Relative Humidity	54%
Pressure :	1010 hPa	Test Power :	AC 230V/50Hz
Test Mode :	BT-GFSK (CH00)		

Polar (H/V)	Frequency	Meter Reading	Factor	Emission Level	Limits	Margin	Remark
	(MHz)	(dBm)	(dB)	(dBm)	(dBm)	(dB)	
V	2133.975	-84.39	10.46	-73.93	-47	-26.93	peak
V	4941.377	-80.65	10.21	-70.44	-47	-23.44	peak
V	2674.6	-77.02	10.57	-66.45	-47	-19.45	peak
V	5114.106	-78.74	16.88	-61.86	-47	-14.86	peak
H	2802.767	-84.25	10.29	-73.96	-47	-26.96	peak
H	5546.828	-82.67	11.29	-71.38	-47	-24.38	peak
H	2869.092	-79.86	6.79	-73.07	-47	-26.07	peak
H	4308.818	-83.17	15.06	-68.11	-47	-21.11	peak

1. Absolute Level= ReadingLevel+ Factor, Margin= Absolute Level – Limit.
2. All the modes had been tested, but only the worst data recorded in the report.

9.6 TEST RESULTS (Conducted measurement)

Test data reference attachment

10. RECEIVER BLOCKING

10.1 PERFORMANCE CRITERIA

The minimum performance criterion shall be a PER less than or equal to 10 %. The manufacturer may declare alternative performance criteria as long as that is appropriate for the intended use of the equipment (see clause 5.4.1.t)).

10.2 LIMITS OF RECEIVER BLOCKING

While maintaining the minimum performance criteria as defined in clause 4.3.1.12.3, the blocking levels at specified frequency offsets shall be equal to or greater than the limits defined for the applicable receiver category provided in table 6, table 7 or table 8.

Table 6: Receiver Blocking parameters for Receiver Category 1 equipment

Wanted signal mean power from companion device (dBm) (see notes 1 and 4)	Blocking signal Frequency (MHz)	Blocking signal power (dBm) (see note 4)	Type of blocking signal
(-133 dBm + 10 × log ₁₀ (OCBW)) or -68 dBm whichever is less (see note 2)	2 380	-34	CW
	2 504		
(-139 dBm + 10 × log ₁₀ (OCBW)) or -74 dBm whichever is less (see note 3)	2 300		
	2 330		
	2 360		
	2524		
	2584		
	2674		

NOTE 1: OCBW is in Hz.

NOTE 2: In case of radiated measurements using a companion device and the level of the wanted signal from the companion device cannot be determined, a relative test may be performed using a wanted signal up to P_{min} + 26 dB where P_{min} is the minimum level of wanted signal required to meet the minimum performance criteria as defined in clause 4.3.1.12.3 in the absence of any blocking signal.

NOTE 3: In case of radiated measurements using a companion device and the level of the wanted signal from the companion device cannot be determined, a relative test may be performed using a wanted signal up to P_{min} + 20 dB where P_{min} is the minimum level of wanted signal required to meet the minimum performance criteria as defined in clause 4.3.1.12.3 in the absence of any blocking signal.

NOTE 4: The level specified is the level at the UUT receiver input assuming a 0 dBi antenna assembly gain. In case of conducted measurements, this level has to be corrected for the (in-band) antenna assembly gain (G). In case of radiated measurements, this level is equivalent to a power flux density (PFD) in front of the UUT antenna with the UUT being configured/positioned as recorded in clause 5.4.3.2.2.

Table 7: Receiver Blocking parameters receiver category 2 equipment

Wanted signal mean power from companion device (dBm) (see notes 1 and 3)	Blocking signal Frequency (MHz)	Blocking signal power (dBm) (see note 3)	Type of blocking signal
(-139 dBm + 10 × log ₁₀ (OCBW) + 10 dB) or (-74 dBm + 10 dB) whichever is less (see note 2)	2 380	-34	CW
	2 504		
	2 300		
	2 584		

NOTE 1: OCBW is in Hz.

NOTE 2: In case of radiated measurements using a companion device and the level of the wanted signal from the companion device cannot be determined, a relative test may be performed using a wanted signal up to P_{min} + 26 dB where P_{min} is the minimum level of wanted signal required to meet the minimum performance criteria as defined in clause 4.3.1.12.3 in the absence of any blocking signal.

NOTE 3: The level specified is the level at the UUT receiver input assuming a 0 dBi antenna assembly gain. In case of conducted measurements, this level has to be corrected for the (in-band) antenna assembly gain (G). In case of radiated measurements, this level is equivalent to a power flux density (PFD) in front of the UUT antenna with the UUT being configured/positioned as recorded in clause 5.4.3.2.2.

Table 8: Receiver Blocking parameters receiver category 3 equipment

Wanted signal mean power from companion device (dBm)	Blocking signal Frequency (MHz)	Blocking signal power (dBm) (see note 2)	Type of blocking signal
(-139 dBm + 10 × log ₁₀ (OCBW) + 20 dB) or (-74 dBm + 20 dB) whichever is less (see note 2)	2 380	-34	CW
	2 504		
	2 300		
	2 584		

NOTE 1: OCBW is in Hz.

NOTE 2: In case of radiated measurements using a companion device and the level of the wanted signal from the companion device cannot be determined, a relative the test may be performed using a wanted signal up to P_{min} + 30 dB where P_{min} is the minimum level of wanted signal required to meet the minimum performance criteria as defined in clause 4.3.1.12.3 in the absence of any blocking signal.

NOTE 3: The level specified is the level at the UUT receiver input assuming a 0 dBi antenna assembly gain. In case of conducted measurements, this level has to be corrected for the (in-band) antenna assembly gain (G). In case of radiated measurements, this level is equivalent to a power flux density (PFD) in front of the UUT antenna with the UUT being configured/positioned as recorded in clause 5.4.3.2.2.

10.3 TEST PROCEDURE

Refer to chapter 5.4.11.2 of ETSI EN 300 328 V2.2.2 (2019-07)

Measurement	
<input checked="" type="checkbox"/> Conducted measurement	<input type="checkbox"/> Radiated measurement

10.4 DEVIATION FROM TEST STANDARD

No deviation

10.5 TEST SETUP

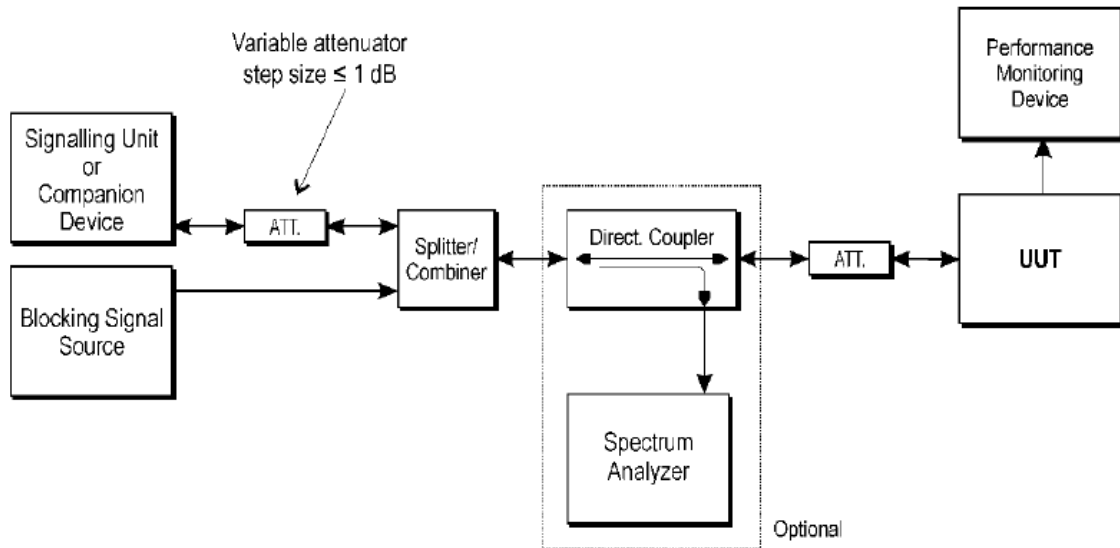

10.6 TEST RESULTS

EUT :	Computer Multimedia Speaker	Model Name :	R23BT
Temperature :	24 °C	Relative Humidity	54%
Pressure :	1010 hPa	Test Power :	AC 230V/50Hz
Test Mode :	BT-GFSK Hopping mode (RX)		

receiver category 2

Wanted signal mean power from companion device (dBm) <small>Note(1)</small>	Blocking signal Frequency (MHz)	Blocking signal power (dBm)	PER % <small>Note(3)</small>	PER Limit %
-69.64	2 380	-34	0.62	≤10%
	2 504		0.77	
	2 300		0.64	≤10%
	2 584		0.63	

EUT :	Computer Multimedia Speaker	Model Name :	R23BT
Temperature :	24 °C	Relative Humidity	54%
Pressure :	1010 hPa	Test Power :	AC 230V/50Hz
Test Mode :	BT-π/4-DQPSK Hopping mode (RX)		

receiver category 2

Wanted signal mean power from companion device (dBm) <small>Note(1)</small>	Blocking signal Frequency (MHz)	Blocking signal power (dBm)	PER % <small>Note(3)</small>	PER Limit %
-68.20	2 380	-34	0.70	≤10%
	2 504		0.65	
	2 300		0.57	≤10%
	2 584		0.53	

11. TEST RESULTS

11.1 Accumulated Transmit Time

Condition	Mode	Frequency (MHz)	Accumulated Transmit Time (ms)	Limit (ms)	Sweep Time (ms)	Burst Number	Verdict
NVNT	1-DH1	2441	117.12	400	31600	320	Pass
NVNT	1-DH3	2441	182	400	31600	112	Pass
NVNT	1-DH5	2441	143.5	400	31600	50	Pass
NVNT	2-DH1	2441	120.84	400	31600	318	Pass
NVNT	2-DH3	2441	174.624	400	31600	107	Pass
NVNT	2-DH5	2441	155.088	400	31600	54	Pass

Dwell NVNT 1-DH1 2441MHz

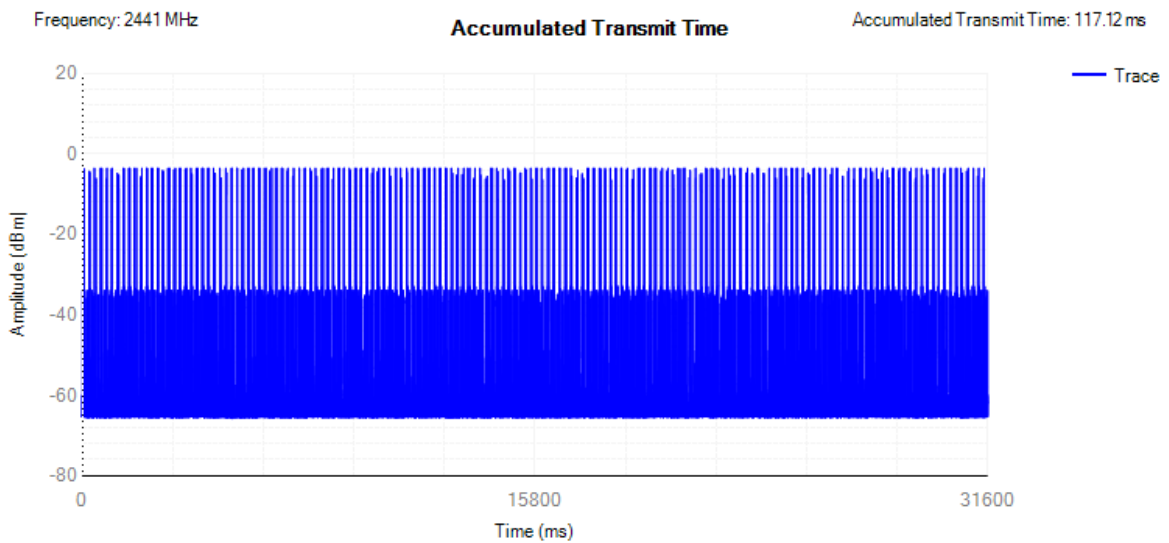

Dwell NVNT 1-DH3 2441MHz

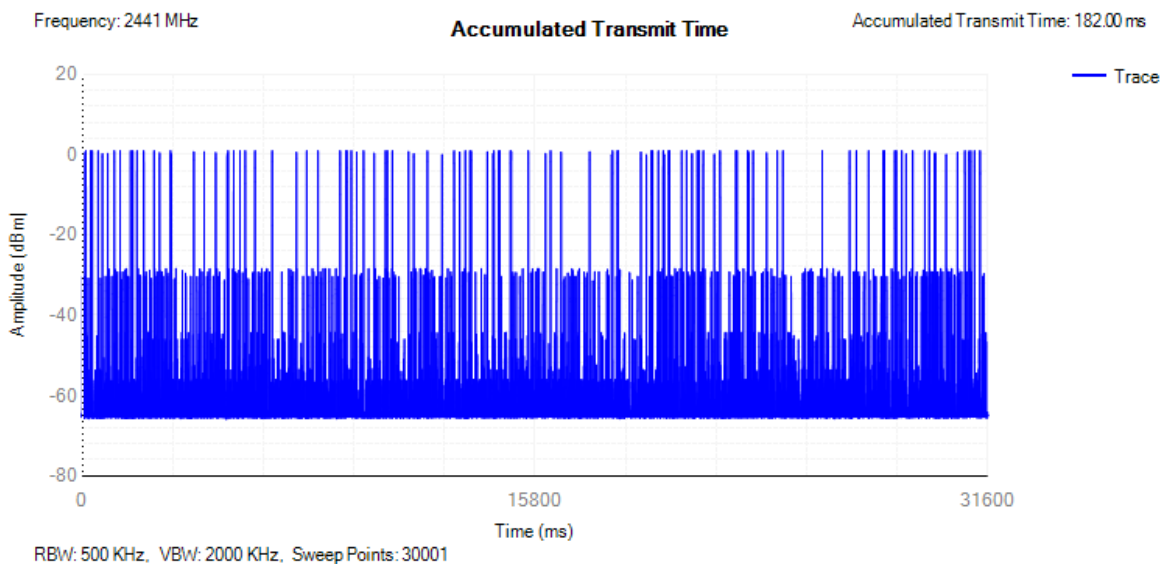

Dwell NVNT 1-DH5 2441MHz

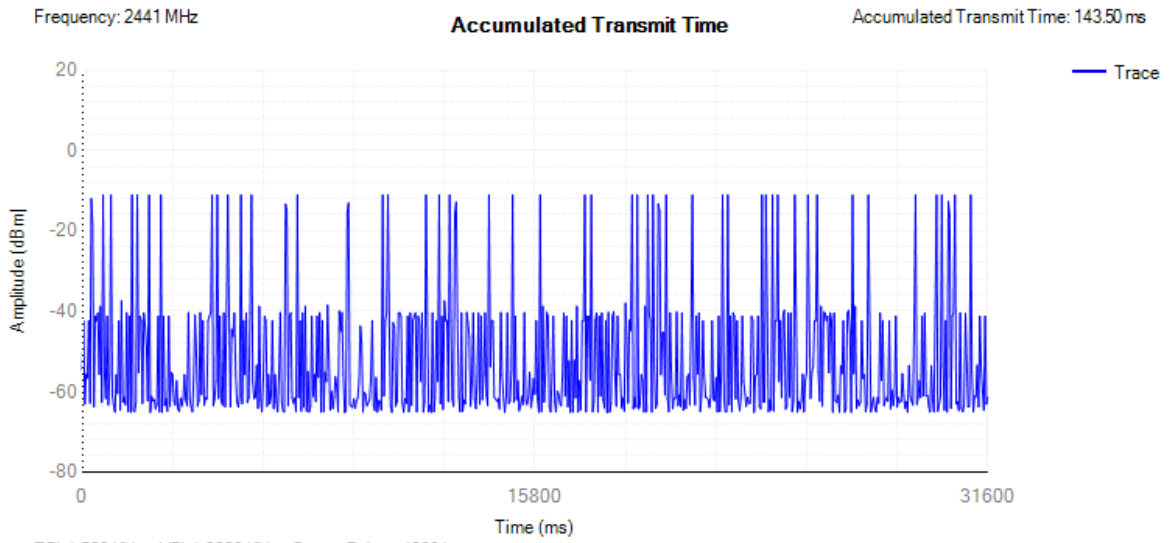

RBW: 500 KHz, VBW: 2000 KHz, Sweep Points: 40001

Dwell NVNT 2-DH1 2441MHz

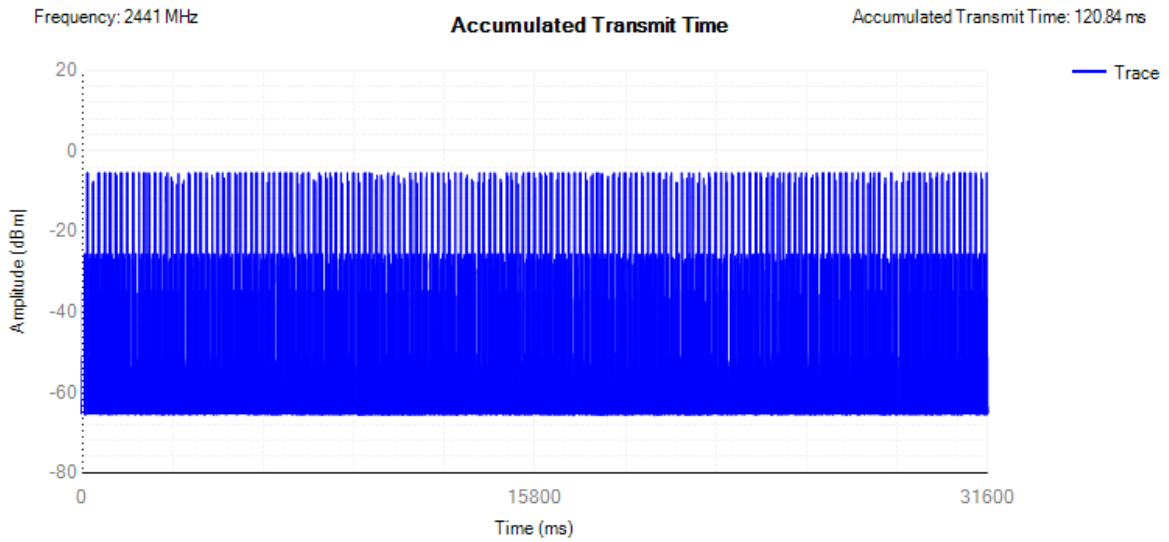

RBW: 500 KHz, VBW: 2000 KHz, Sweep Points: 30001

Dwell NVNT 2-DH3 2441MHz

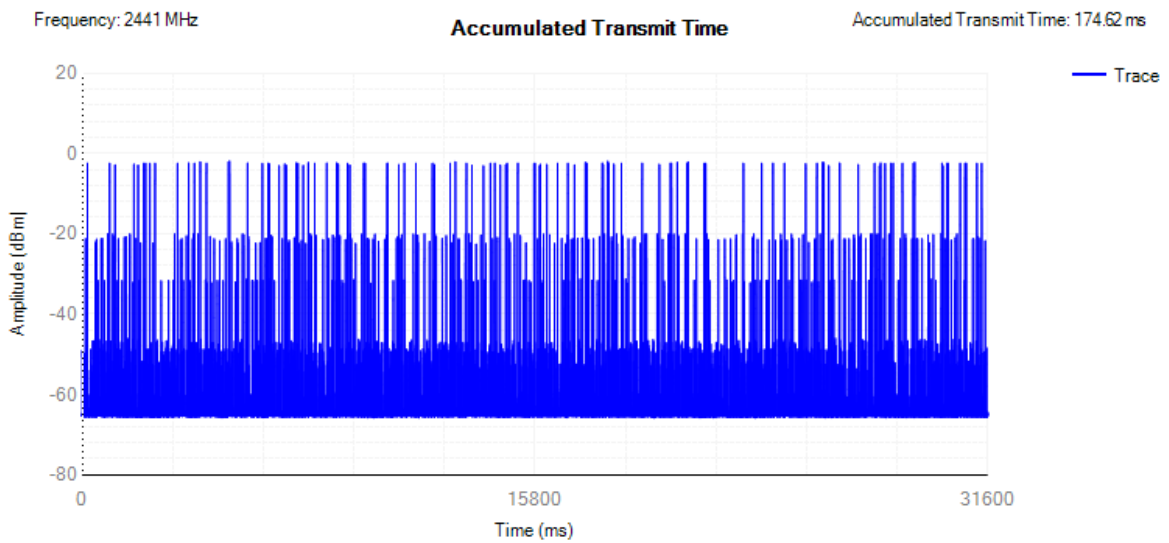

RBW: 500 KHz, VBW: 2000 KHz, Sweep Points: 30001

Dwell NVNT 2-DH5 2441MHz

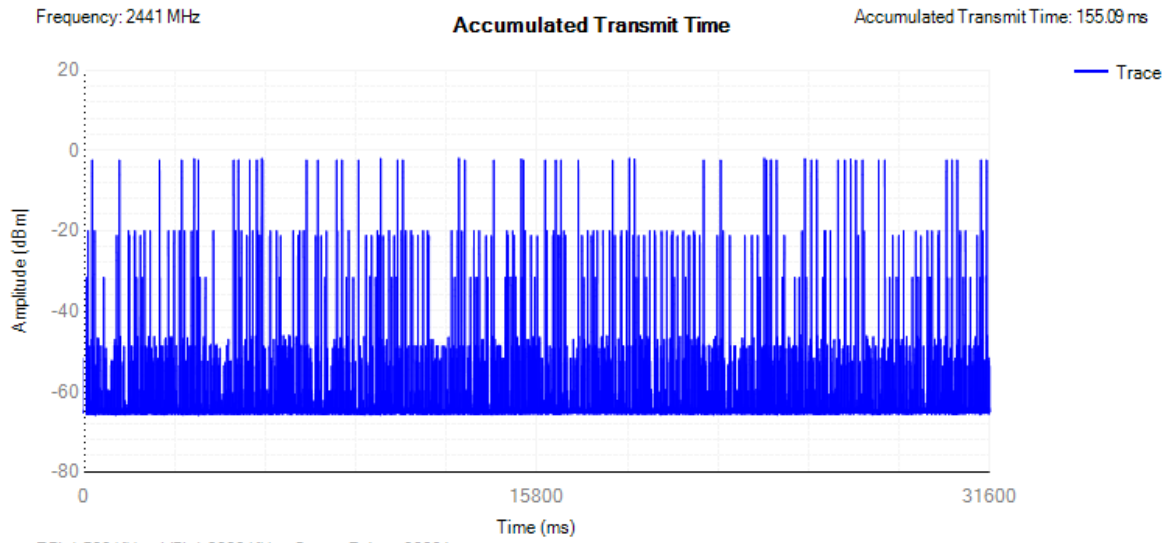

11.2 Frequency Occupation

Condition	Mode	Frequency (MHz)	Frequency Occupation (ms)	Limit (ms)	Sweep Time (ms)	Burst Number	Verdict
NVNT	1-DH1	2441	0.732	0	115.656	2	Pass
NVNT	1-DH3	2441	3.25	0	513.5	2	Pass
NVNT	1-DH5	2441	5.74	0	906.92	2	Pass
NVNT	2-DH1	2441	0.76	0	120.08	2	Pass
NVNT	2-DH3	2441	3.264	0	515.712	2	Pass
NVNT	2-DH5	2441	8.616	0	907.552	3	Pass

Freq. Occup. NVNT 1-DH1 2441MHz

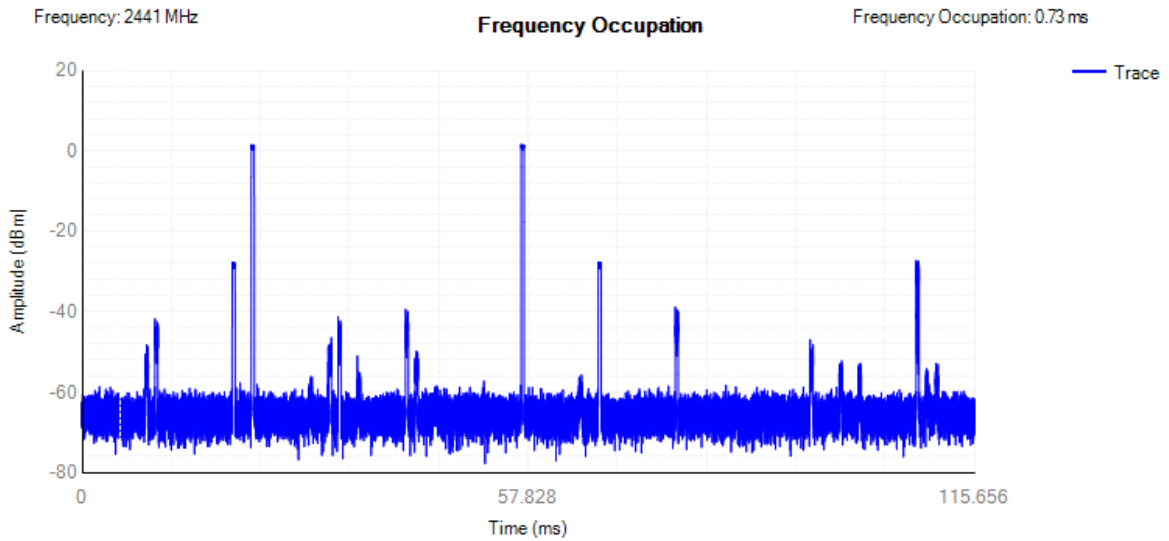

Freq. Occup. NVNT 1-DH3 2441MHz

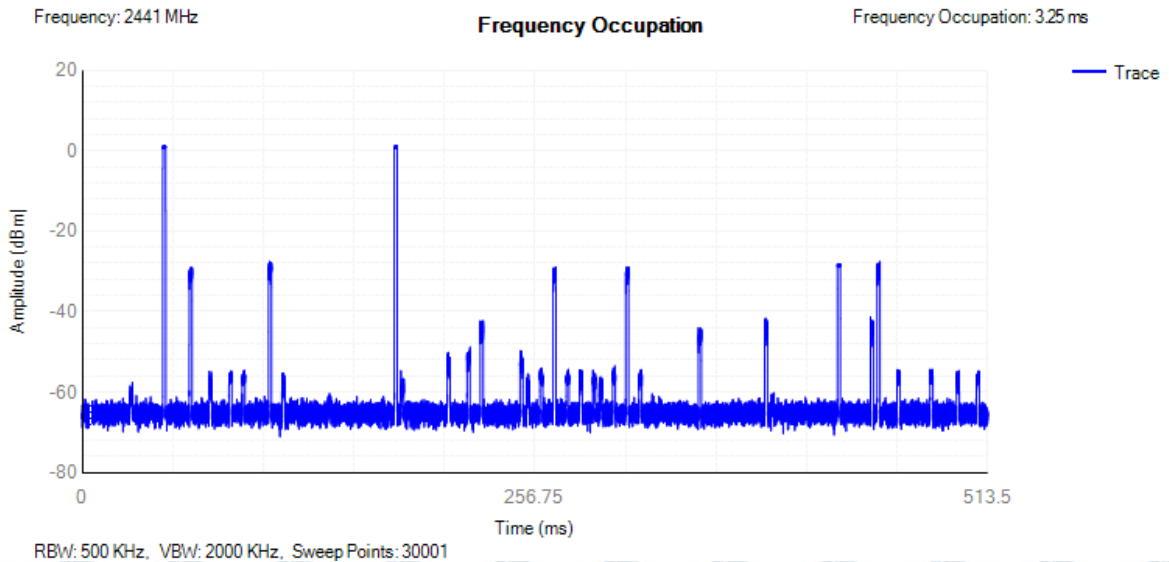

Freq. Occup. NVNT 1-DH5 2441MHz

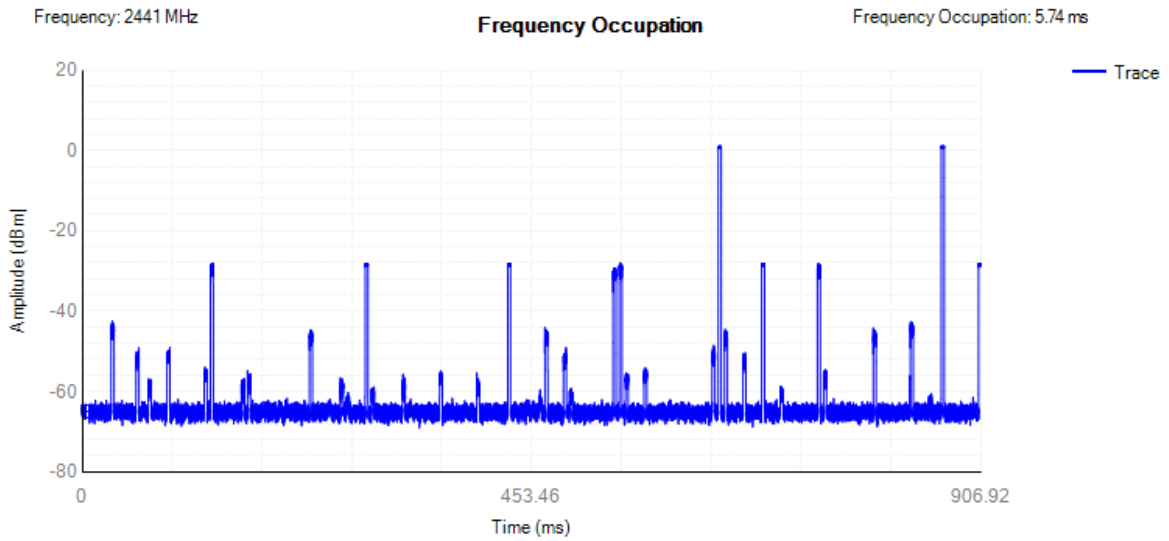

Freq. Occup. NVNT 2-DH1 2441MHz

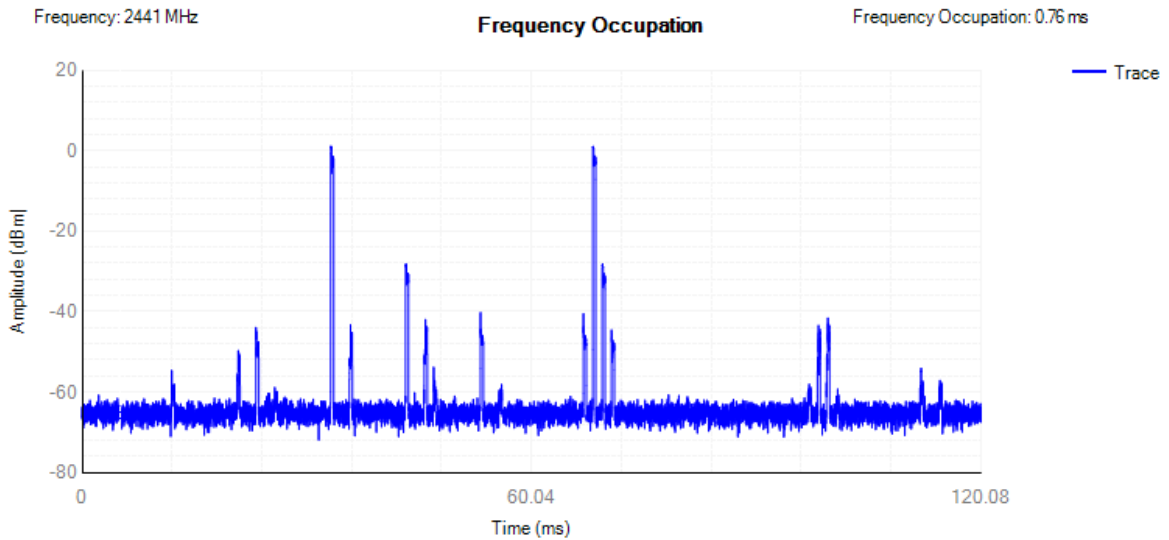

Freq. Occup. NVNT 2-DH3 2441MHz

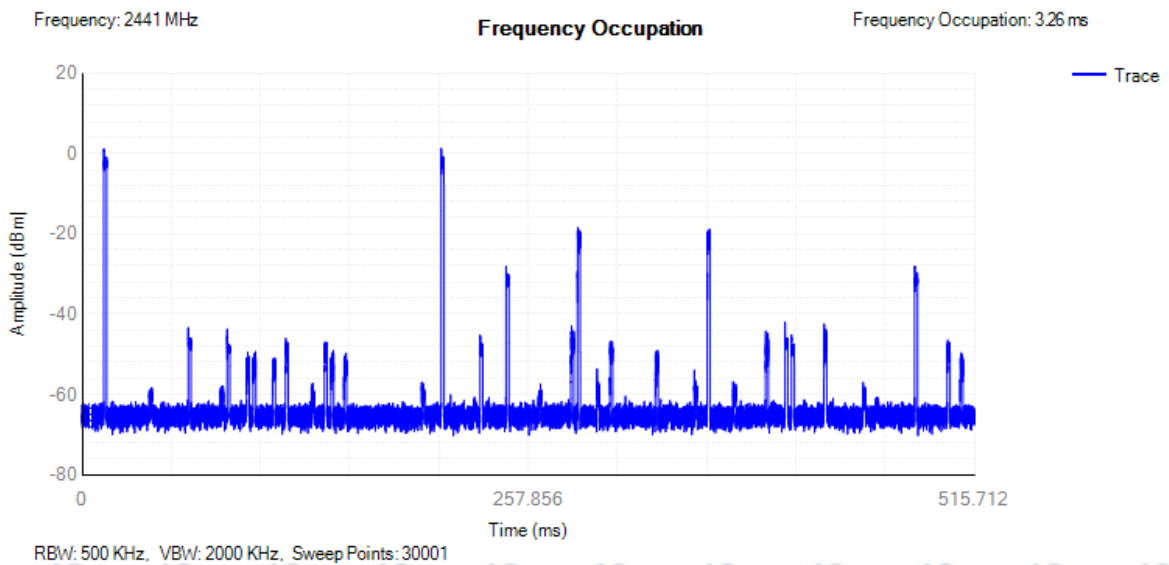

Freq. Occup. NVNT 2-DH5 2441MHz

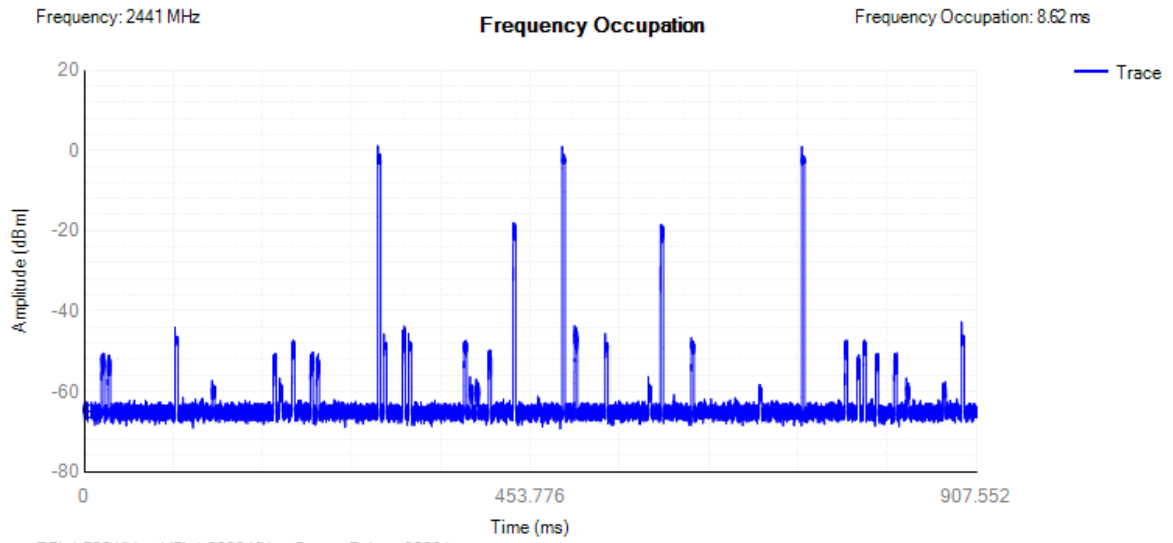

11.3 One Pulse Dwell Time

Condition	Mode	Frequency (MHz)	Pulse Time (ms)
NVNT	1-DH1	2441	0.366
NVNT	1-DH3	2441	1.625
NVNT	1-DH5	2441	2.87
NVNT	2-DH1	2441	0.38
NVNT	2-DH3	2441	1.632
NVNT	2-DH5	2441	2.872

One Pulse NVNT 1-DH1 2441MHz

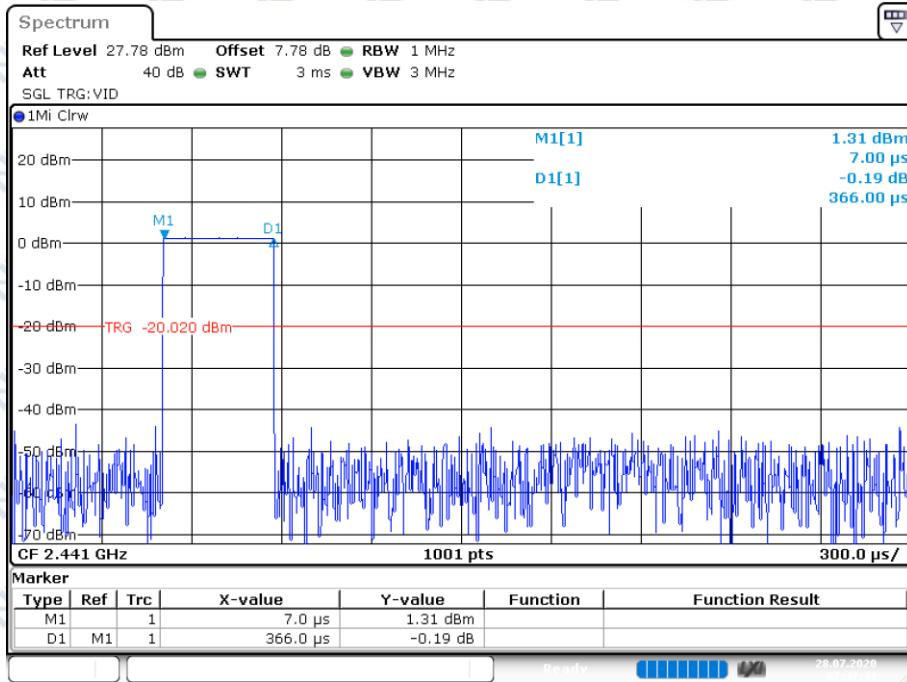

Date: 28.JUL.2020 07:47:41

One Pulse NVNT 1-DH3 2441MHz

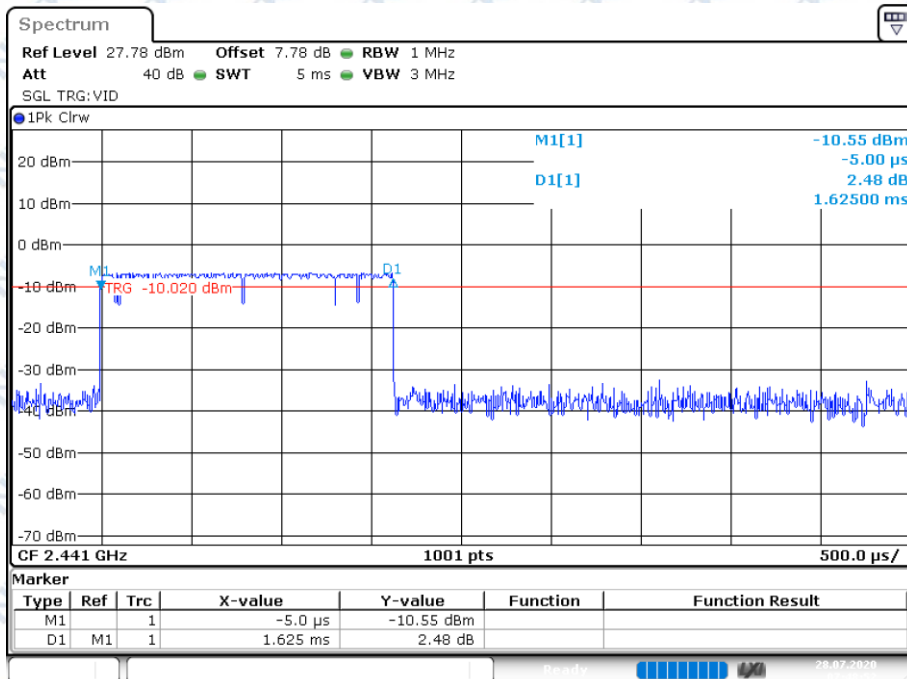

Date: 28.JUL.2020 07:48:52

One Pulse NVNT 1-DH5 2441MHz

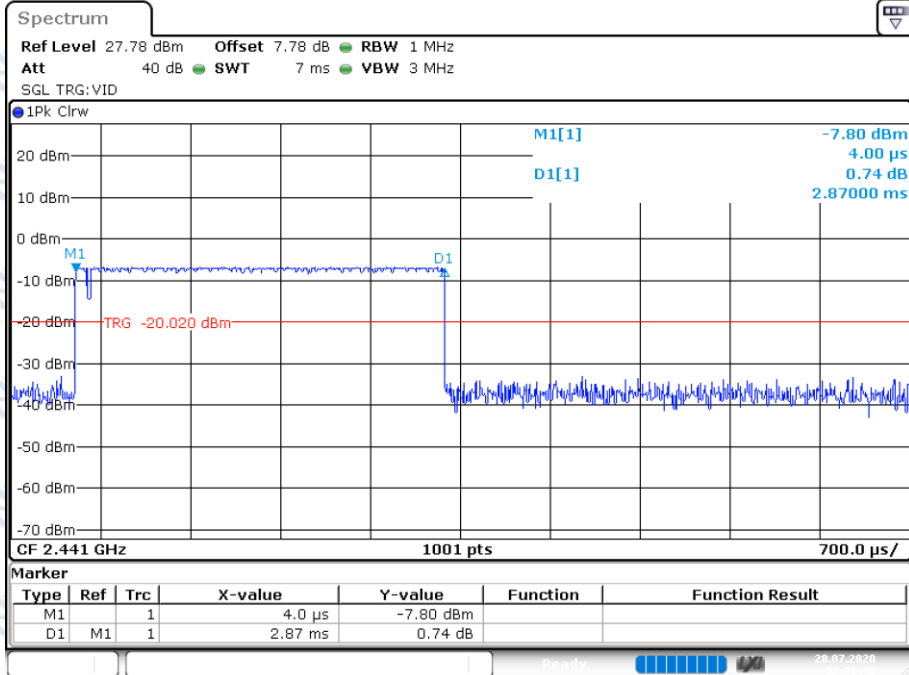

One Pulse NVNT 2-DH1 2441MHz

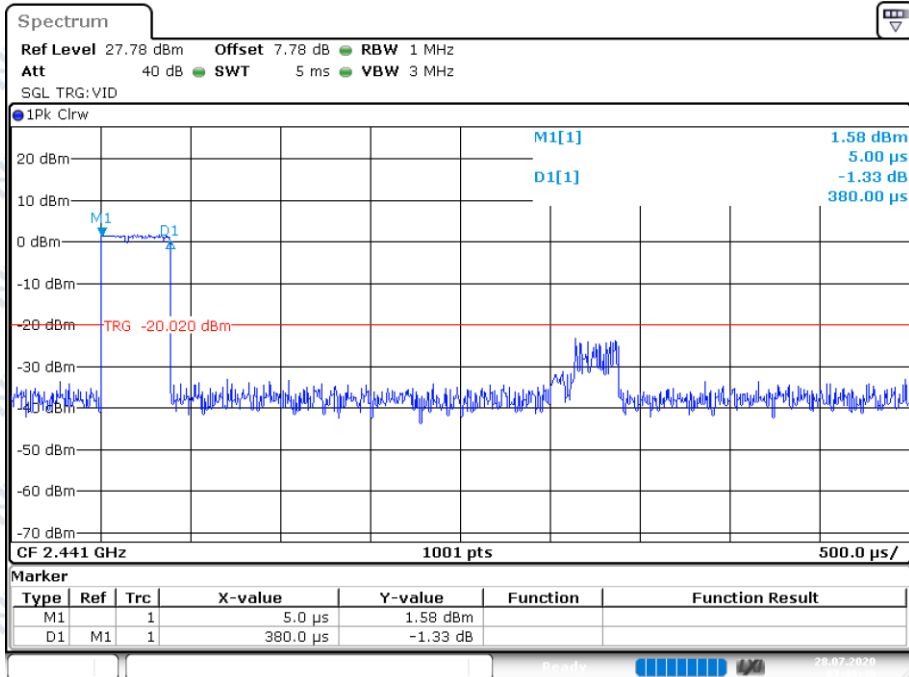

One Pulse NVNT 2-DH3 2441MHz

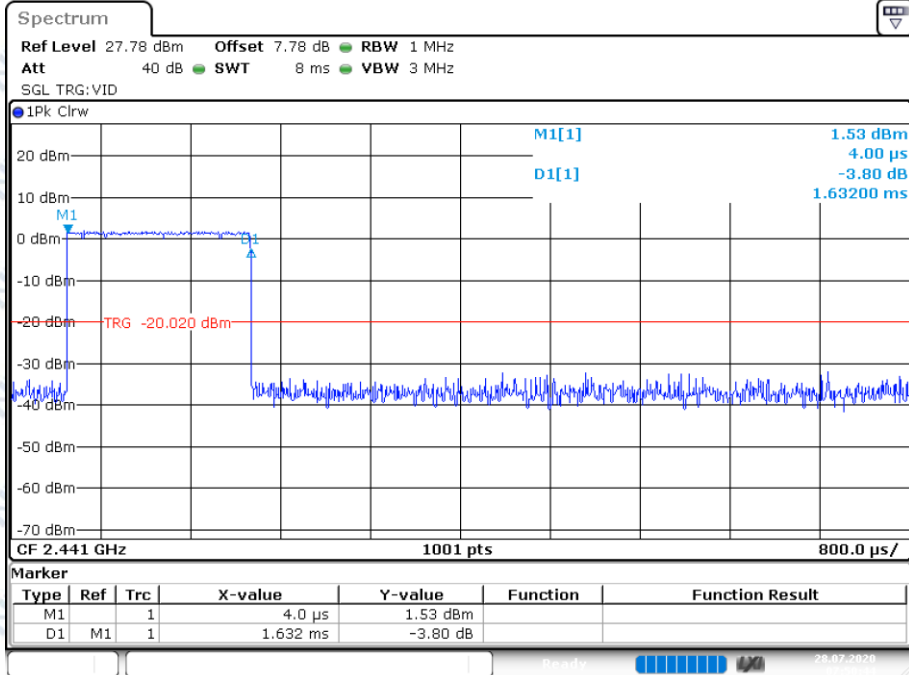

Date: 28.JUL.2020 07:50:44

One Pulse NVNT 2-DH5 2441MHz

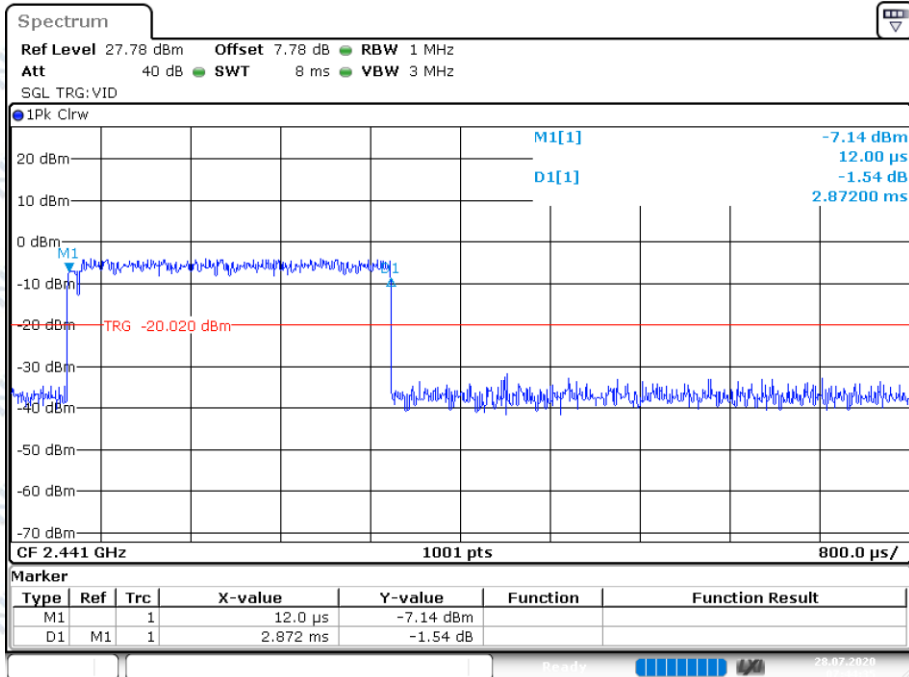

Date: 28.JUL.2020 07:44:35

11.4 RF Output Power

Condition	Mode	Frequency (MHz)	Max Burst RMS Power (dBm)	Burst Number	Max EIRP (dBm)	Limit (dBm)	Verdict
NVNT	1-DH5	hopping	2.04	16	5.04	20	Pass
NVNT	2-DH5	hopping	1.36	17	4.36	20	Pass
NVLT	1-DH5	hopping	1.36	16	4.36	20	Pass
NVLT	2-DH5	hopping	0.77	17	3.77	20	Pass
NVHT	1-DH5	hopping	1.33	16	4.33	20	Pass
NVHT	2-DH5	hopping	0.67	17	3.67	20	Pass

Power NVNT 1-DH5 2402MHz

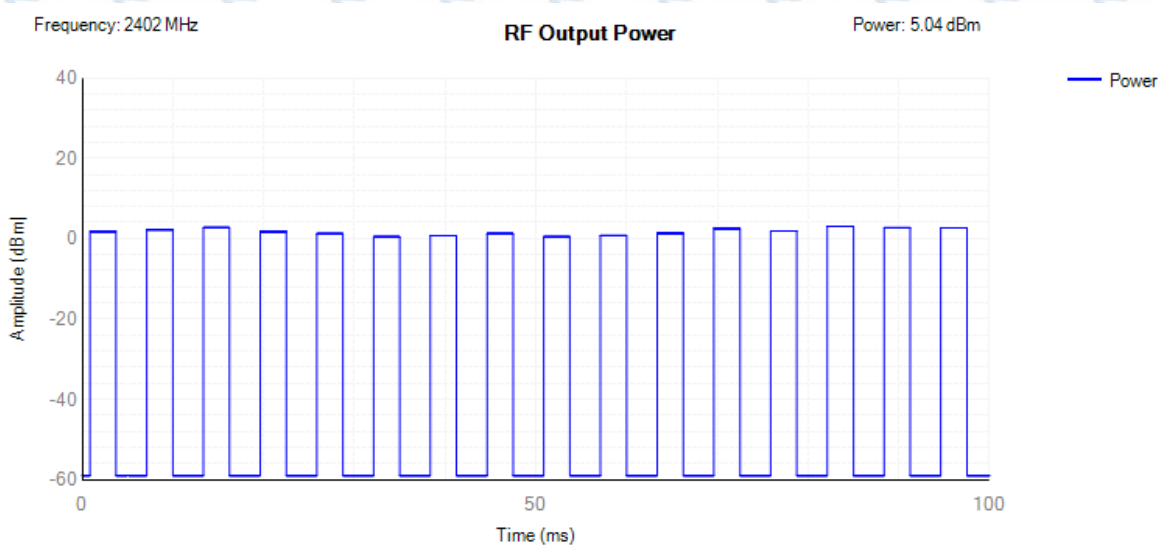

Power NVNT 2-DH5 2402MHz

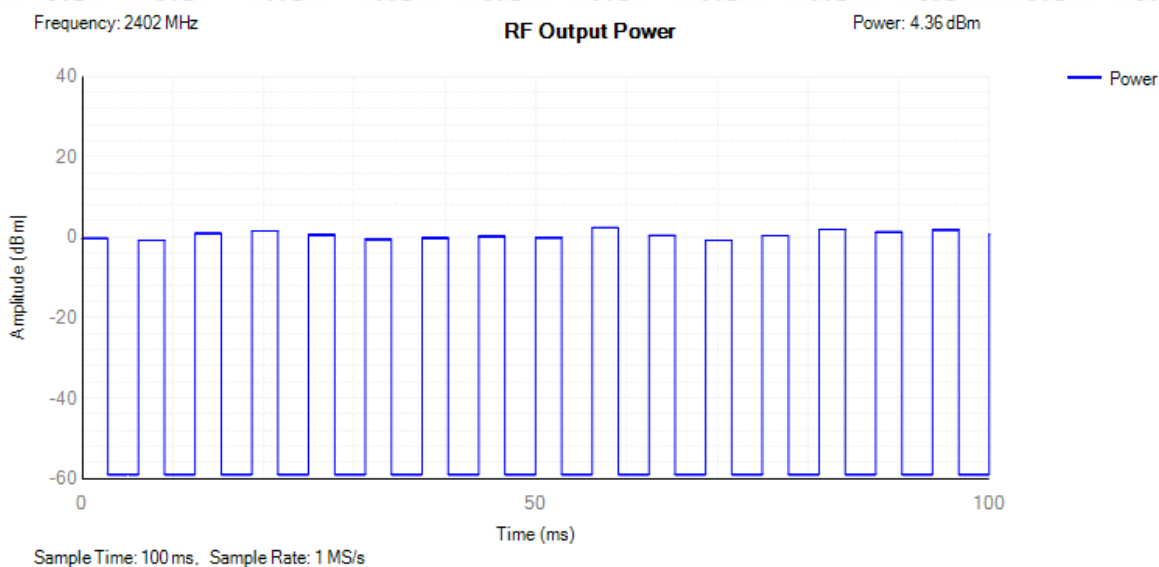

11.5 Hopping Frequency Separation

Condition	Mode	Hopping Freq1 (MHz)	Hopping Freq2 (MHz)	HFS (MHz)	Limit (MHz)	Verdict
NVNT	1-DH5	2401.99	2402.9401	0.9501	0.1	Pass
NVNT	1-DH5	2440.9864	2442.0493	1.0629	0.1	Pass
NVNT	1-DH5	2479.0494	2480.0496	1.0002	0.1	Pass
NVNT	2-DH5	2401.9903	2402.9899	0.9996	0.1	Pass
NVNT	2-DH5	2440.9852	2441.9926	1.0074	0.1	Pass
NVNT	2-DH5	2478.993	2479.9881	0.9951	0.1	Pass

HFS NVNT 1-DH5 2402MHz

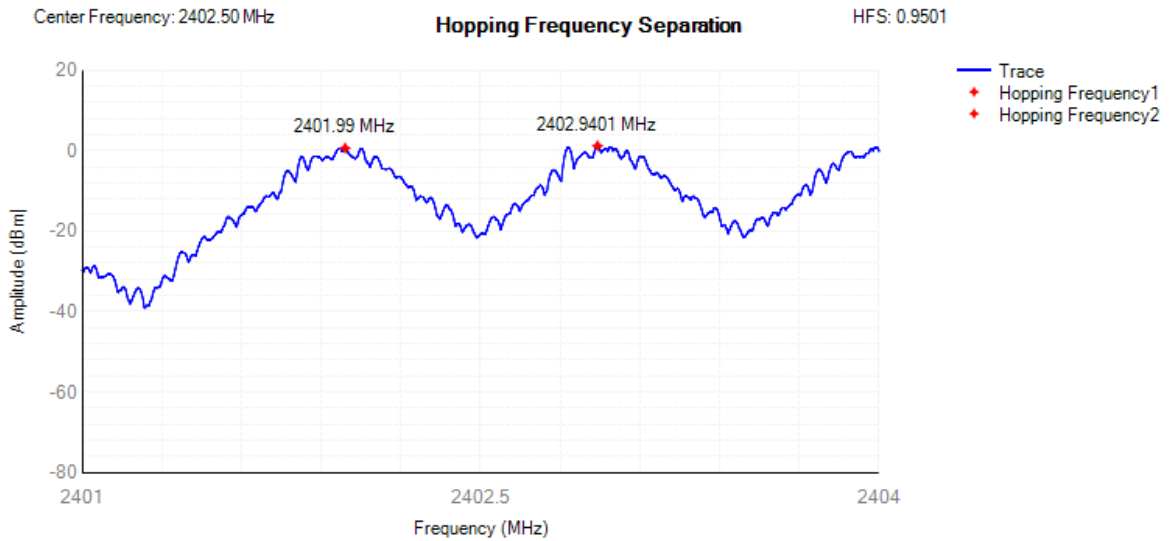

HFS NVNT 1-DH5 2441MHz

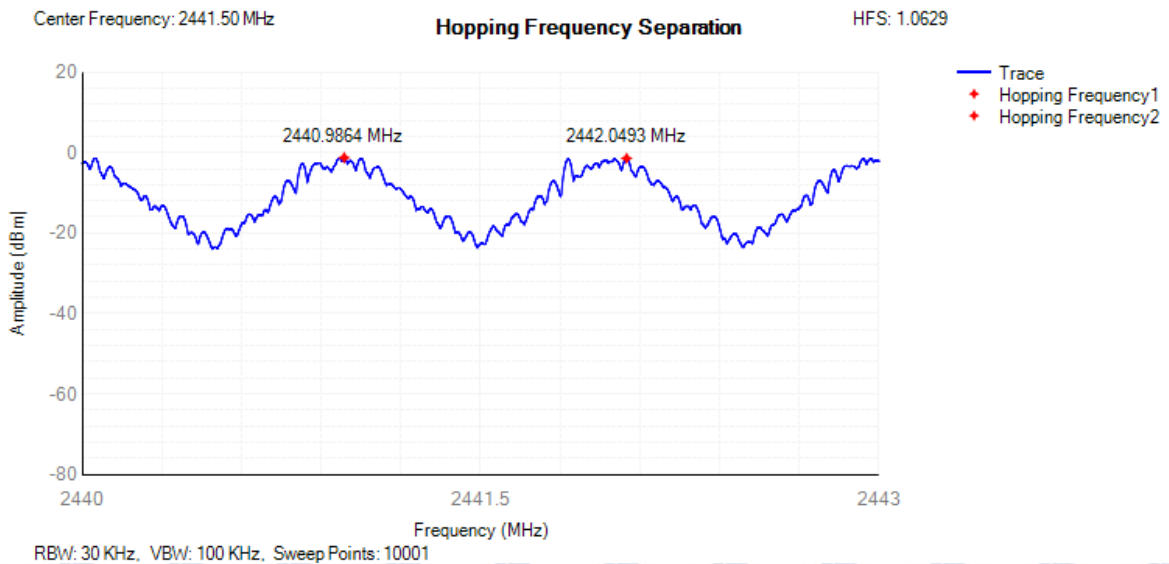

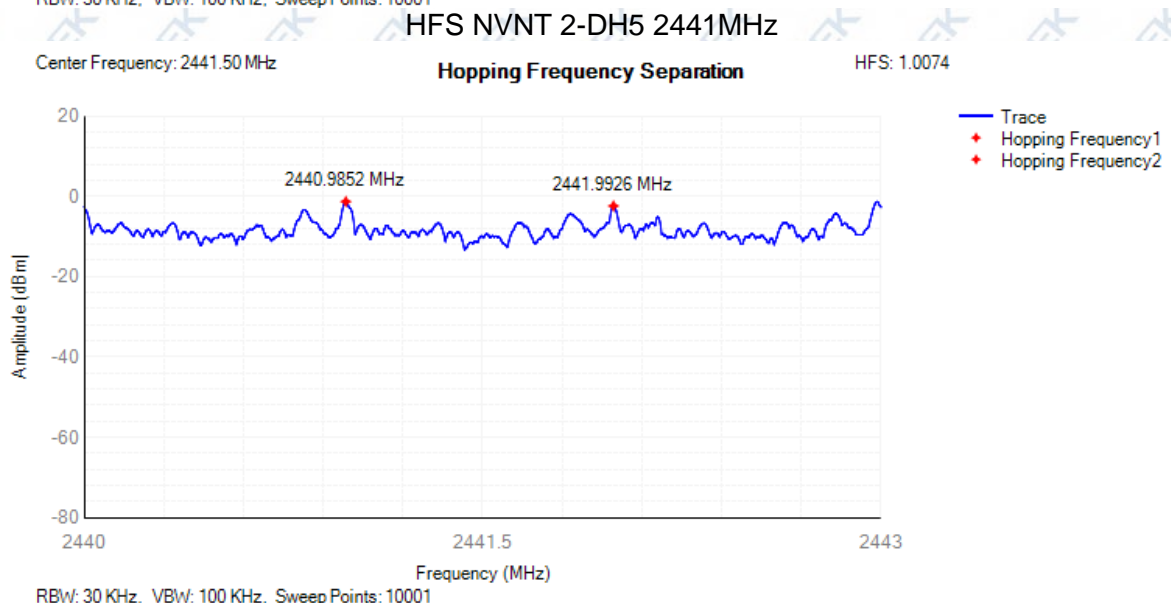
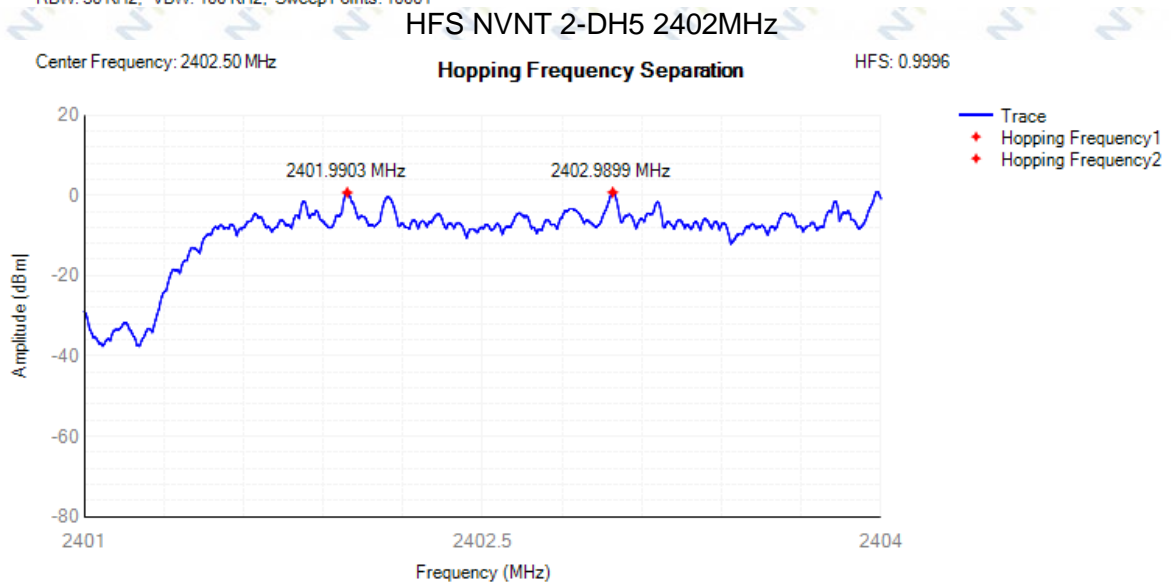
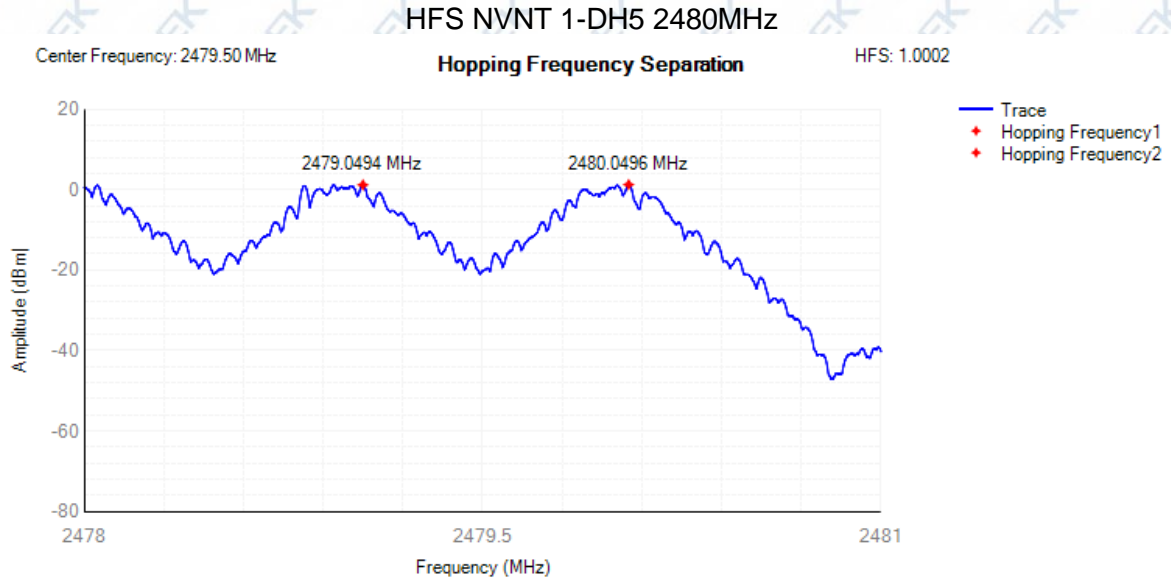

HFS NVNT 2-DH5 2480MHz

Center Frequency: 2479.50 MHz

Hopping Frequency Separation

HFS: 0.9951

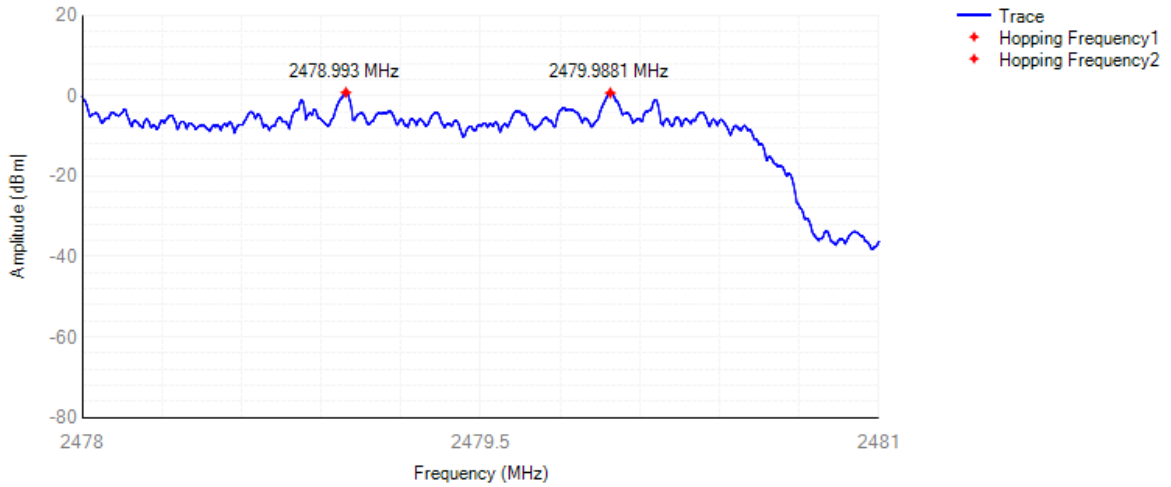

RBW: 30 KHz, VBW: 100 KHz, Sweep Points: 10001

11.6 Occupied Channel Bandwidth

Condition	Mode	Frequency (MHz)	Center Frequency (MHz)	OBW (MHz)	Lower Edge (MHz)	Upper Edge (MHz)	Limit OBW (MHz)	Verdict
NVNT	1-DH5	2402	2401.988	0.863	2401.556	2402.42	2400 - 2483.5MHz	Pass
NVNT	1-DH5	2480	2479.988	0.863	2479.556	2480.42	2400 - 2483.5MHz	Pass
NVNT	2-DH5	2402	2401.993	1.201	2401.393	2402.593	2400 - 2483.5MHz	Pass
NVNT	2-DH5	2480	2479.99	1.191	2479.395	2480.585	2400 - 2483.5MHz	Pass

OBW NVNT 1-DH5 2402MHz

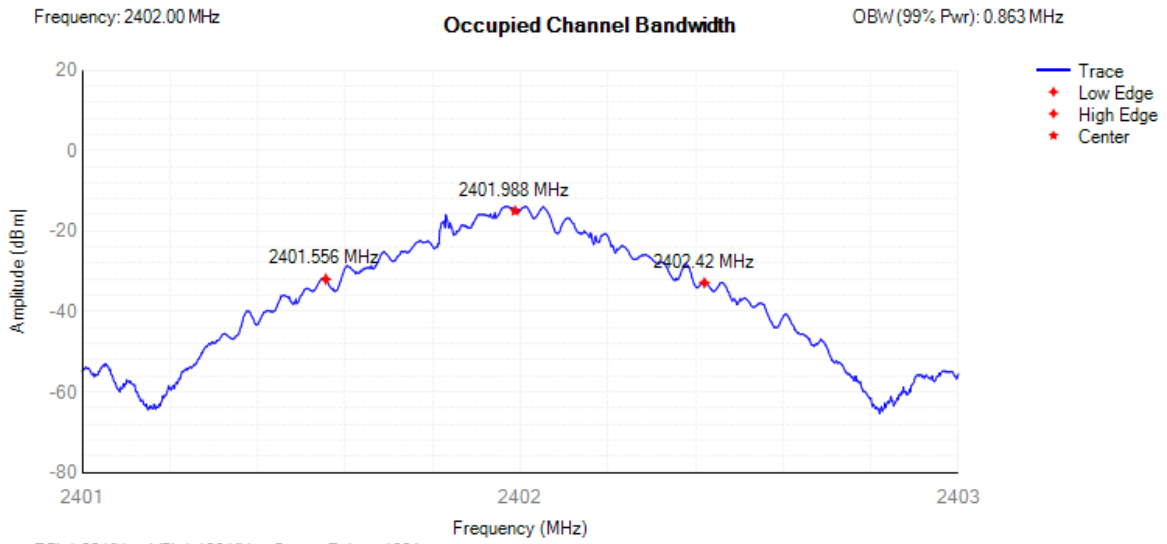

OBW NVNT 1-DH5 2480MHz

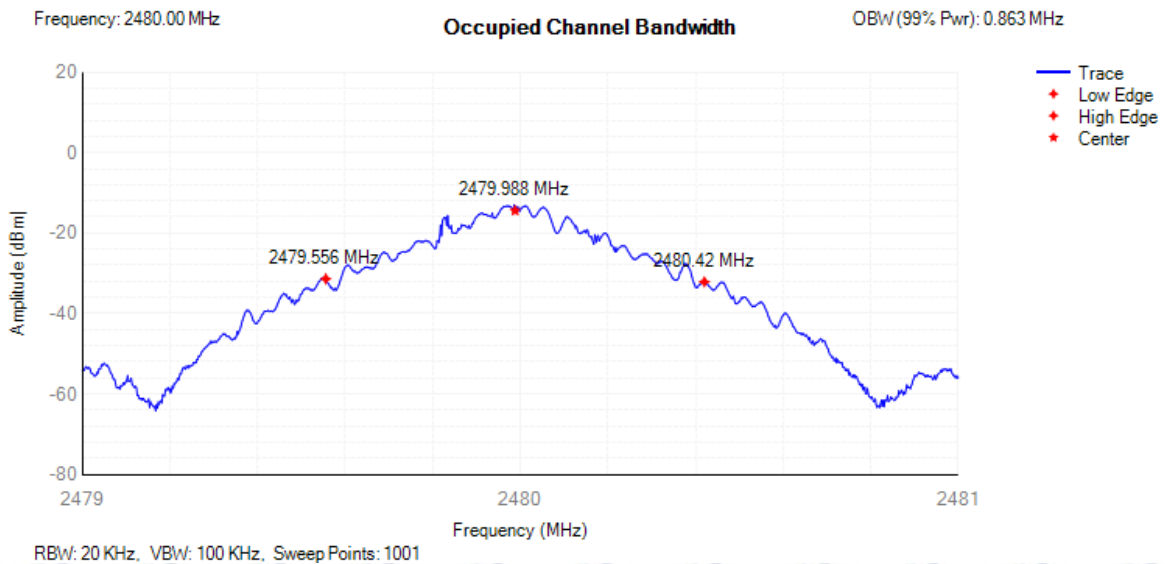

OBW NVNT 2-DH5 2402MHz

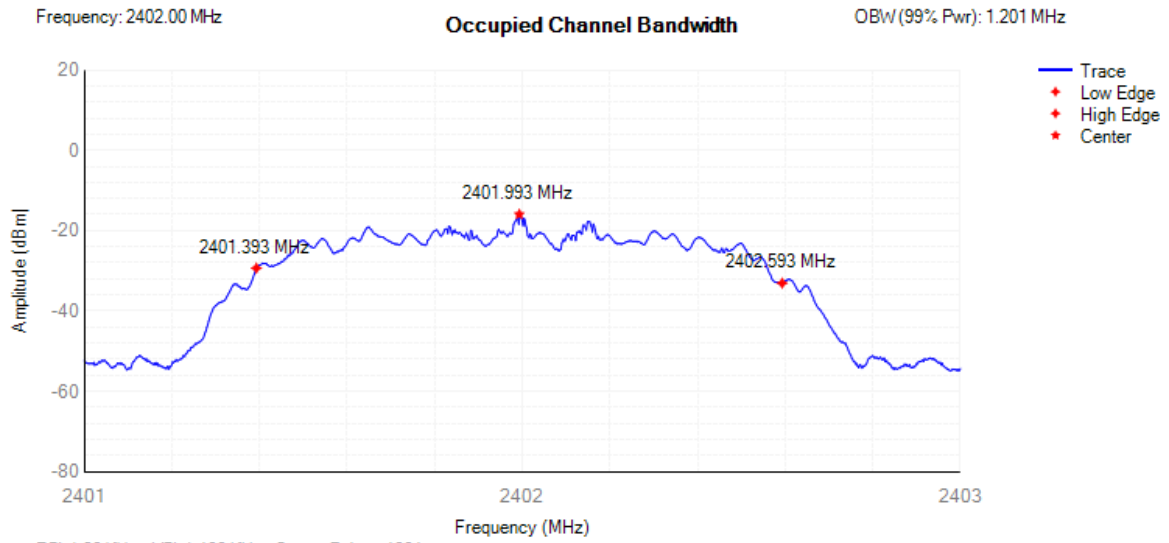

OBW NVNT 2-DH5 2480MHz

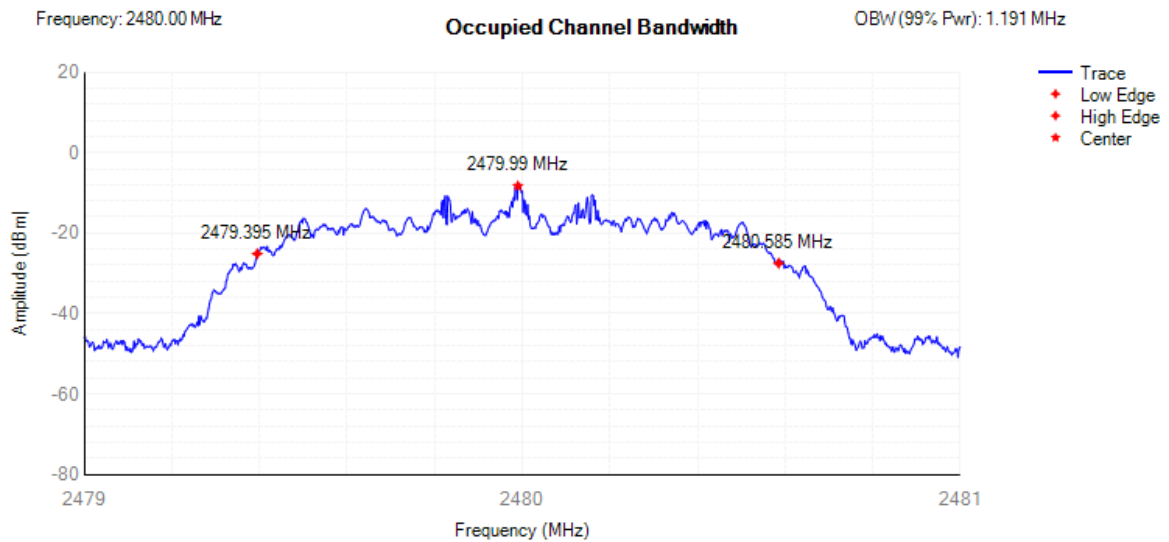

11.7 Transmitter unwanted emissions in the spurious domain

Condition	Mode	Frequency (MHz)	Range	Spur Freq (MHz)	Spur Level Peak(dBm)	Spur Level RMS(dBm)	Limit (dBm)	Verdict
NVNT	1-DH5	2402	30 MHz -47 MHz	30.65	-65.73	NA	-36	Pass
NVNT	1-DH5	2402	47 MHz -74 MHz	65.5	-65.84	NA	-54	Pass
NVNT	1-DH5	2402	74 MHz -87.5 MHz	74.7	-65.94	NA	-36	Pass
NVNT	1-DH5	2402	87.5 MHz -118 MHz	95.9	-64.79	NA	-54	Pass
NVNT	1-DH5	2402	118 MHz -174 MHz	145.65	-65.46	NA	-36	Pass
NVNT	1-DH5	2402	174 MHz -230 MHz	206	-64.51	NA	-54	Pass
NVNT	1-DH5	2402	230 MHz -470 MHz	398.45	-63.48	NA	-36	Pass
NVNT	1-DH5	2402	470 MHz -694 MHz	483.45	-64.22	NA	-54	Pass
NVNT	1-DH5	2402	694 MHz -1000 MHz	945.85	-62.36	NA	-36	Pass
NVNT	1-DH5	2402	1000 MHz -2398 MHz	2394	-37.47	NA	-30	Pass
NVNT	1-DH5	2402	2485.5 MHz -12750 MHz	7205.5	-42.84	NA	-30	Pass
NVNT	1-DH5	2441	30 MHz -47 MHz	37.8	-64.85	NA	-36	Pass
NVNT	1-DH5	2441	47 MHz -74 MHz	71.55	-64.77	NA	-54	Pass
NVNT	1-DH5	2441	74 MHz -87.5 MHz	85.75	-66	NA	-36	Pass
NVNT	1-DH5	2441	87.5 MHz -118 MHz	107.55	-65.64	NA	-54	Pass
NVNT	1-DH5	2441	118 MHz -174 MHz	169.2	-64.57	NA	-36	Pass
NVNT	1-DH5	2441	174 MHz -230 MHz	200.45	-64.4	NA	-54	Pass
NVNT	1-DH5	2441	230 MHz -470 MHz	310.15	-63.61	NA	-36	Pass
NVNT	1-DH5	2441	470 MHz -694 MHz	580.85	-63.59	NA	-54	Pass
NVNT	1-DH5	2441	694 MHz -1000 MHz	910.25	-61	NA	-36	Pass
NVNT	1-DH5	2441	1000 MHz -2398 MHz	2393	-51.28	NA	-30	Pass
NVNT	1-DH5	2441	2485.5 MHz -12750 MHz	12410.5	-43.4	NA	-30	Pass
NVNT	1-DH5	2480	30 MHz -47 MHz	41.55	-64.22	NA	-36	Pass
NVNT	1-DH5	2480	47 MHz -74 MHz	72.55	-65.2	NA	-54	Pass
NVNT	1-DH5	2480	74 MHz -87.5 MHz	83.8	-65.5	NA	-36	Pass
NVNT	1-DH5	2480	87.5 MHz -118 MHz	103.05	-64.89	NA	-54	Pass
NVNT	1-DH5	2480	118 MHz -174 MHz	150.85	-64.19	NA	-36	Pass
NVNT	1-DH5	2480	174 MHz -230 MHz	229.15	-64.29	NA	-54	Pass
NVNT	1-DH5	2480	230 MHz -470 MHz	391.65	-63.32	NA	-36	Pass
NVNT	1-DH5	2480	470 MHz -694 MHz	482.85	-63.68	NA	-54	Pass
NVNT	1-DH5	2480	694 MHz -1000 MHz	986.3	-62.61	NA	-36	Pass
NVNT	1-DH5	2480	1000 MHz -2398 MHz	2389	-51.88	NA	-30	Pass

NVNT	1-DH5	2480	2485.5 MHz -12750 MHz	12169.5	-42.41	NA	-30	Pass
NVNT	2-DH5	2402	30 MHz -47 MHz	36.85	-65.17	NA	-36	Pass
NVNT	2-DH5	2402	47 MHz -74 MHz	60.45	-64.5	NA	-54	Pass
NVNT	2-DH5	2402	74 MHz -87.5 MHz	84.75	-65.86	NA	-36	Pass
NVNT	2-DH5	2402	87.5 MHz -118 MHz	96.05	-65.84	NA	-54	Pass
NVNT	2-DH5	2402	118 MHz -174 MHz	167.8	-64.73	NA	-36	Pass
NVNT	2-DH5	2402	174 MHz -230 MHz	205.7	-64.62	NA	-54	Pass
NVNT	2-DH5	2402	230 MHz -470 MHz	457.35	-62.84	NA	-36	Pass
NVNT	2-DH5	2402	470 MHz -694 MHz	653.5	-64.45	NA	-54	Pass
NVNT	2-DH5	2402	694 MHz -1000 MHz	948.35	-61.99	NA	-36	Pass
NVNT	2-DH5	2402	1000 MHz -2398 MHz	2397.5	-27.22	-30.09	-30	Pass
NVNT	2-DH5	2402	2485.5 MHz -12750 MHz	2616	-38.58	NA	-30	Pass
NVNT	2-DH5	2441	30 MHz -47 MHz	40.75	-65.01	NA	-36	Pass
NVNT	2-DH5	2441	47 MHz -74 MHz	68.05	-65.06	NA	-54	Pass
NVNT	2-DH5	2441	74 MHz -87.5 MHz	74.3	-65.51	NA	-36	Pass
NVNT	2-DH5	2441	87.5 MHz -118 MHz	94.4	-64.85	NA	-54	Pass
NVNT	2-DH5	2441	118 MHz -174 MHz	156.95	-64.32	NA	-36	Pass
NVNT	2-DH5	2441	174 MHz -230 MHz	182	-64.23	NA	-54	Pass
NVNT	2-DH5	2441	230 MHz -470 MHz	241.5	-64.08	NA	-36	Pass
NVNT	2-DH5	2441	470 MHz -694 MHz	513.55	-63.99	NA	-54	Pass
NVNT	2-DH5	2441	694 MHz -1000 MHz	907.65	-63.04	NA	-36	Pass
NVNT	2-DH5	2441	1000 MHz -2398 MHz	2393.5	-51.77	NA	-30	Pass
NVNT	2-DH5	2441	2485.5 MHz -12750 MHz	12399	-42.85	NA	-30	Pass
NVNT	2-DH5	2480	30 MHz -47 MHz	39.05	-64.53	NA	-36	Pass
NVNT	2-DH5	2480	47 MHz -74 MHz	48	-65.16	NA	-54	Pass
NVNT	2-DH5	2480	74 MHz -87.5 MHz	74.55	-65.1	NA	-36	Pass
NVNT	2-DH5	2480	87.5 MHz -118 MHz	105.6	-64.67	NA	-54	Pass
NVNT	2-DH5	2480	118 MHz -174 MHz	165.35	-64.08	NA	-36	Pass
NVNT	2-DH5	2480	174 MHz -230 MHz	183.1	-64.03	NA	-54	Pass
NVNT	2-DH5	2480	230 MHz -470 MHz	267.8	-63.72	NA	-36	Pass
NVNT	2-DH5	2480	470 MHz -694 MHz	599.75	-63.45	NA	-54	Pass
NVNT	2-DH5	2480	694 MHz -1000 MHz	943.4	-60.8	NA	-36	Pass
NVNT	2-DH5	2480	1000 MHz -2398 MHz	1813.5	-51.94	NA	-30	Pass
NVNT	2-DH5	2480	2485.5 MHz -12750 MHz	2621	-37.28	NA	-30	Pass

Tx. Spurious NVNT 1-DH5 2402MHz

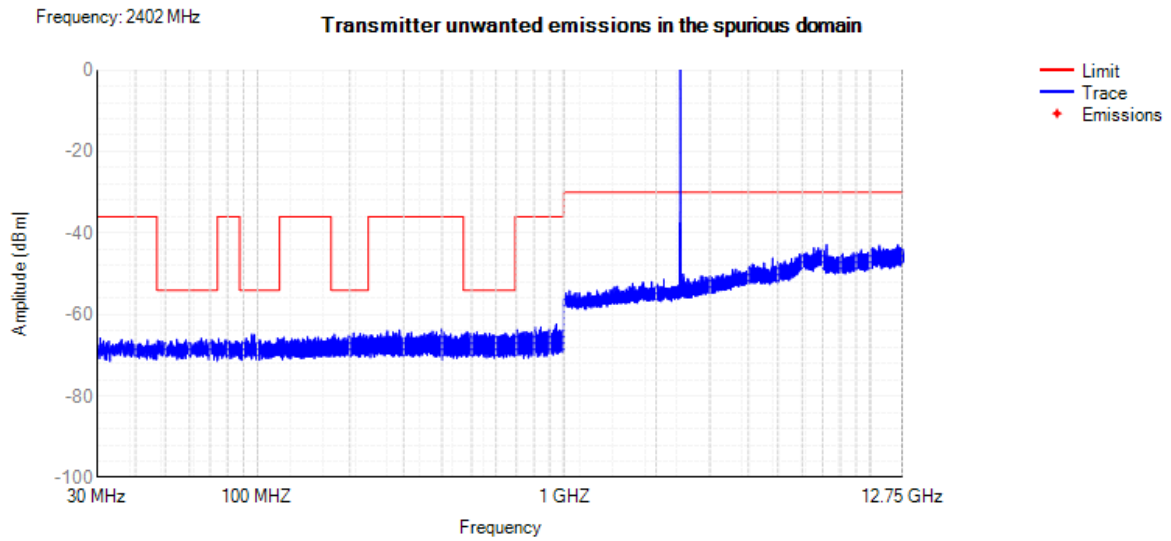

Tx. Spurious NVNT 1-DH5 2441MHz

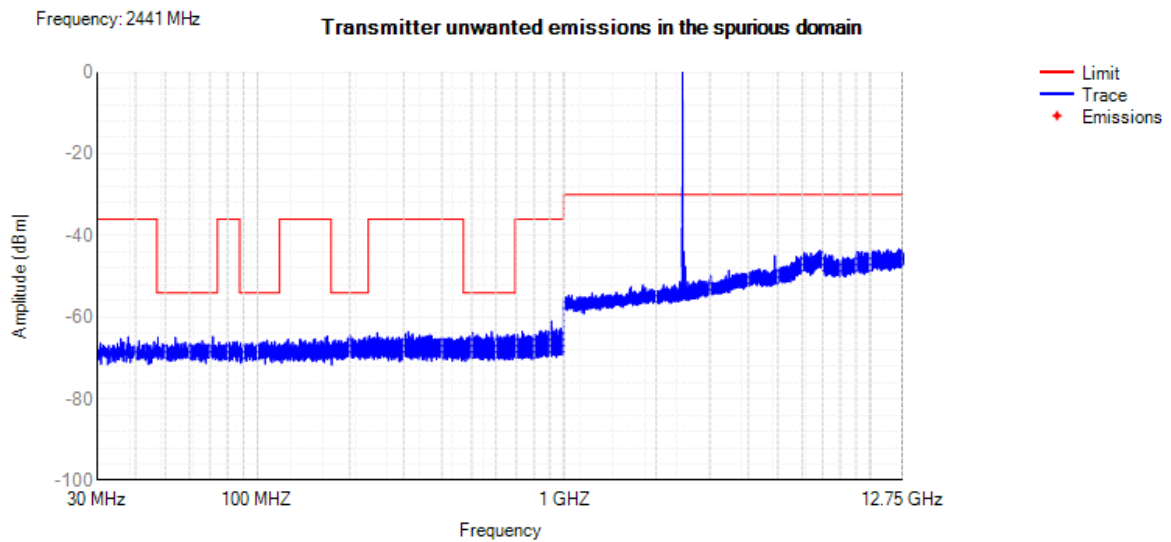

Tx. Spurious NVNT 1-DH5 2480MHz

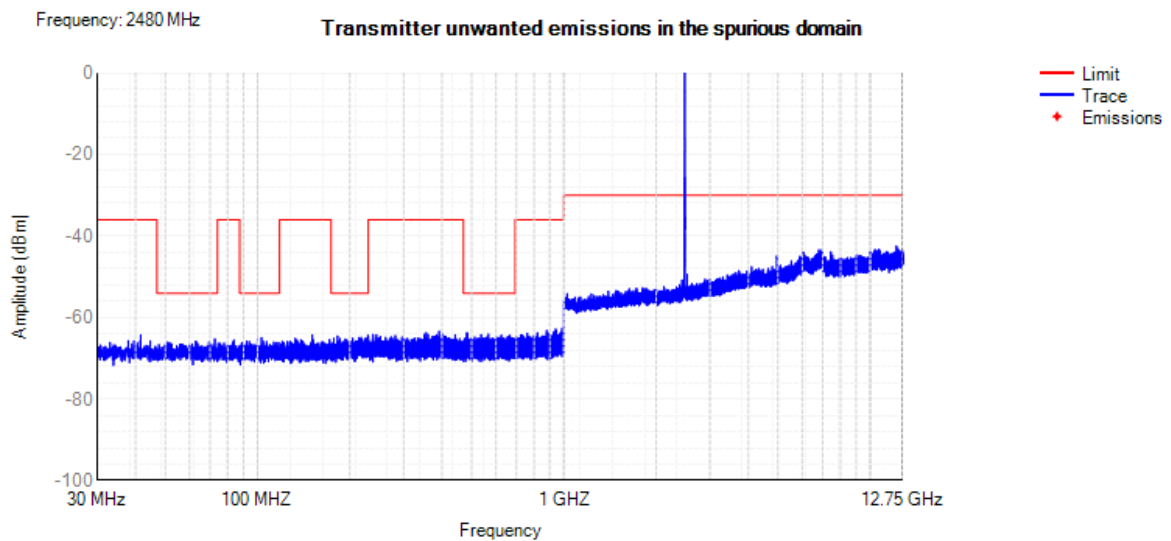

Tx. Spurious NVNT 2-DH5 2402MHz

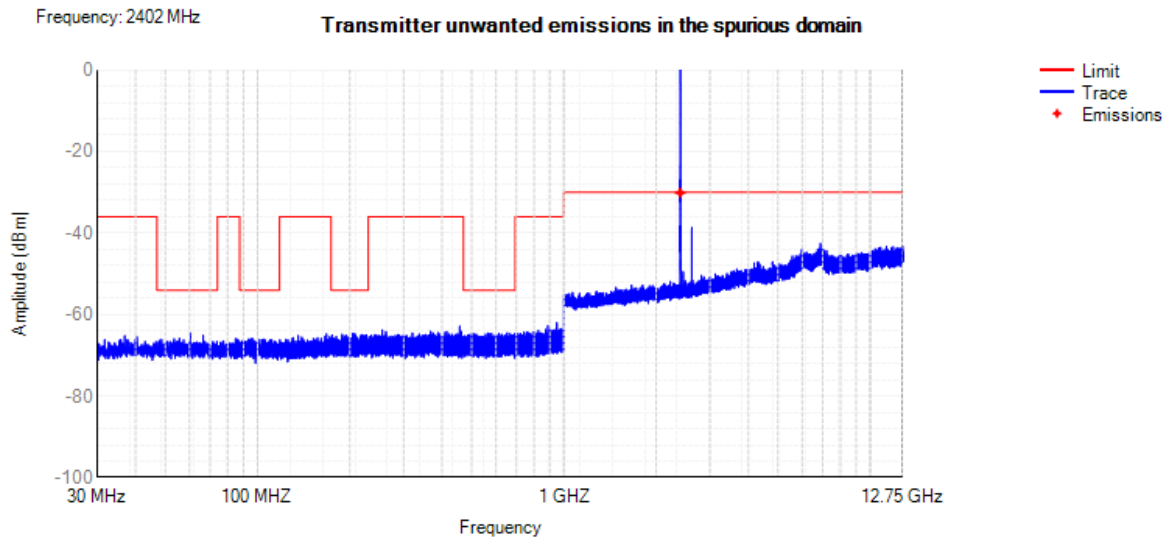

Tx. Spurious NVNT 2-DH5 2441MHz

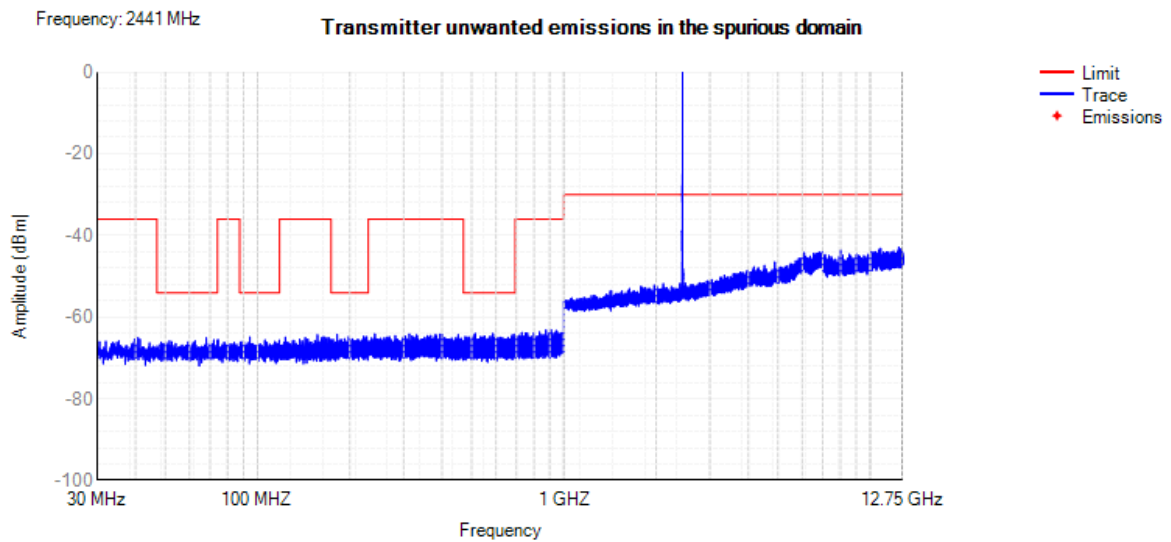

Tx. Spurious NVNT 2-DH5 2480MHz

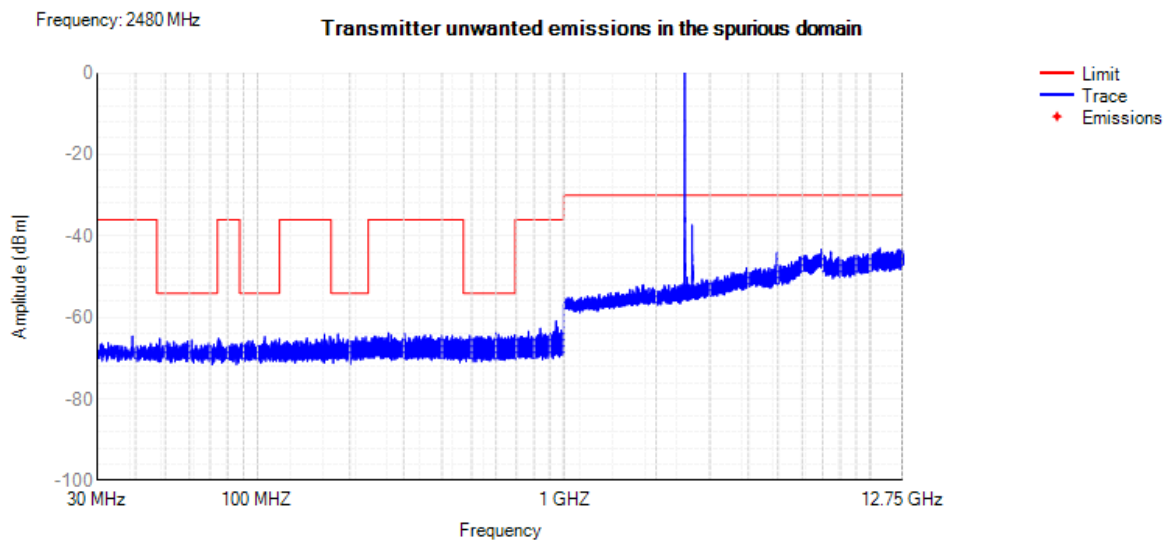

11.8 Receiver spurious emissions

Condition	Mode	Frequency (MHz)	Range	Spur Freq (MHz)	Spur Level Peak(dBm)	Spur Level RMS(dBm)	Limit (dBm)	Verdict
NVNT	1-DH5	2402	30 MHz -1000 MHz	810.7	-71.87	NA	-57	Pass
NVNT	1-DH5	2402	1000 MHz -12750 MHz	10639.5	-52.58	-58.31	-47	Pass
NVNT	1-DH5	2441	30 MHz -1000 MHz	792.65	-71.88	NA	-57	Pass
NVNT	1-DH5	2441	1000 MHz -12750 MHz	10721.5	-53.07	NA	-47	Pass
NVNT	1-DH5	2480	30 MHz -1000 MHz	257.2	-72.09	NA	-57	Pass
NVNT	1-DH5	2480	1000 MHz -12750 MHz	12218	-53.28	NA	-47	Pass
NVNT	2-DH5	2402	30 MHz -1000 MHz	706.85	-71.63	NA	-57	Pass
NVNT	2-DH5	2402	1000 MHz -12750 MHz	12379.5	-53.47	NA	-47	Pass
NVNT	2-DH5	2441	30 MHz -1000 MHz	257.8	-71.93	NA	-57	Pass
NVNT	2-DH5	2441	1000 MHz -12750 MHz	6215	-54.07	NA	-47	Pass
NVNT	2-DH5	2480	30 MHz -1000 MHz	796.3	-70.88	NA	-57	Pass
NVNT	2-DH5	2480	1000 MHz -12750 MHz	11899.5	-53.31	NA	-47	Pass

Rx. Spurious NVNT 1-DH5 2402MHz

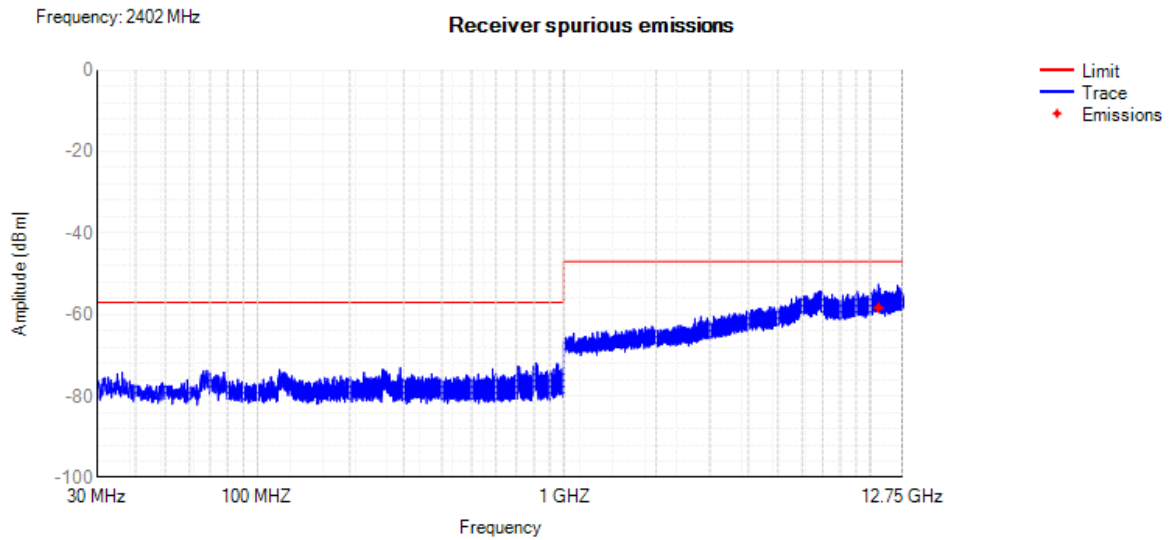

Rx. Spurious NVNT 1-DH5 2441MHz

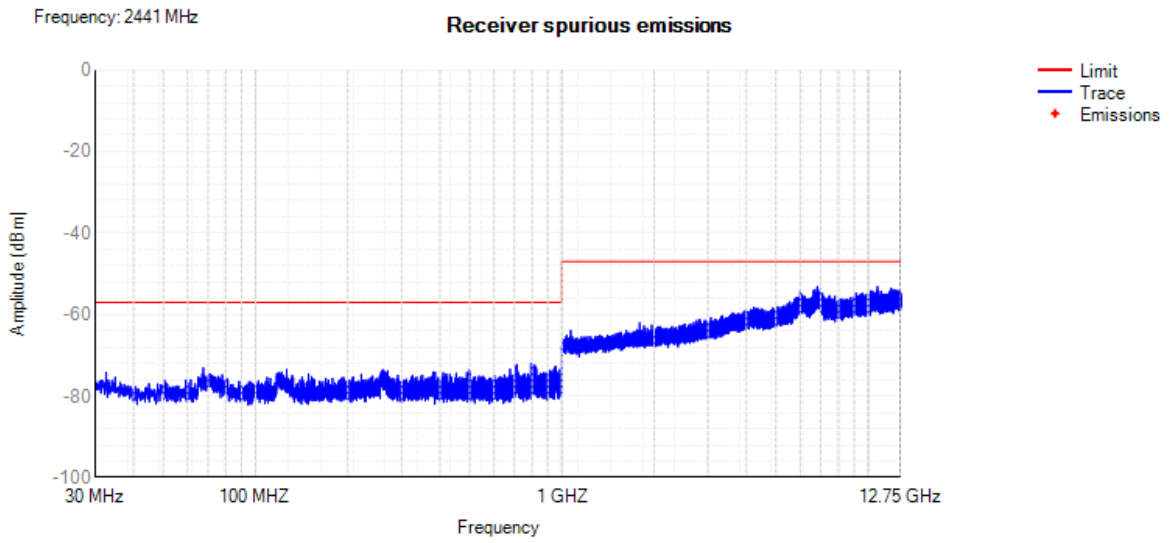

Rx. Spurious NVNT 1-DH5 2480MHz

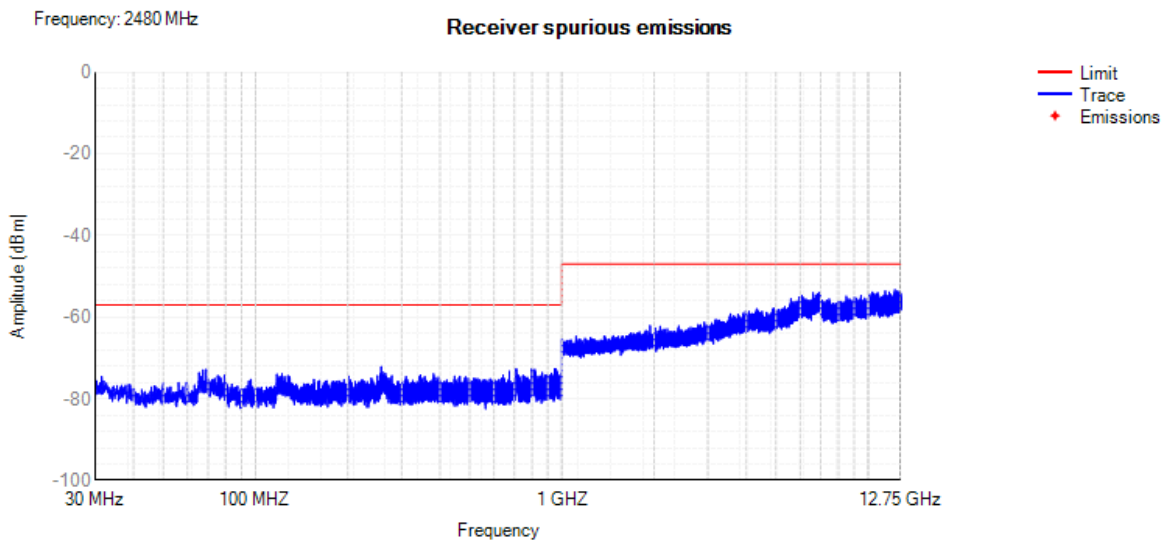

Rx. Spurious NVNT 2-DH5 2402MHz

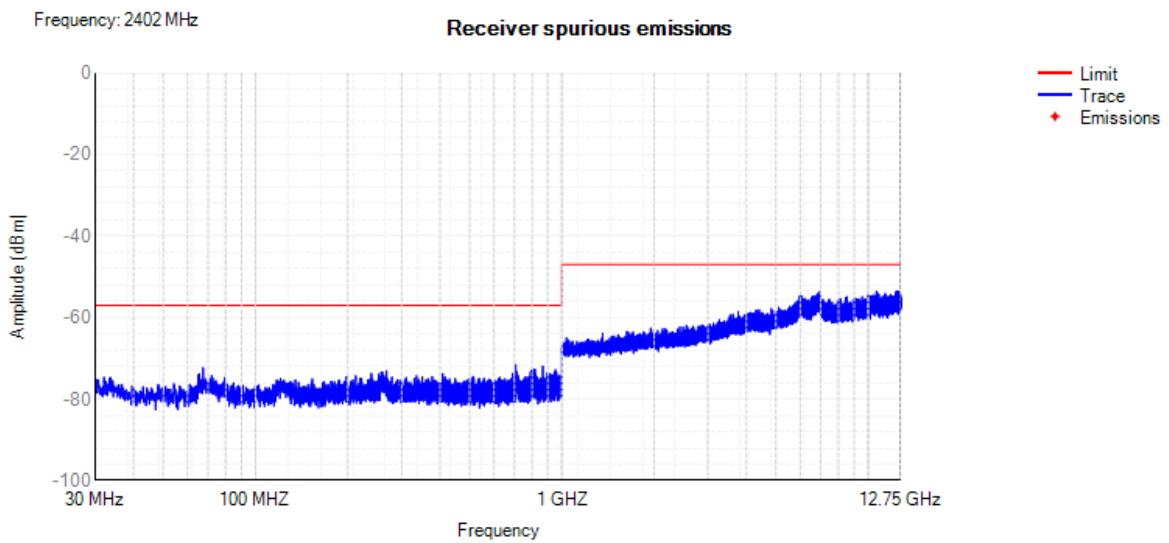

Rx. Spurious NVNT 2-DH5 2441MHz

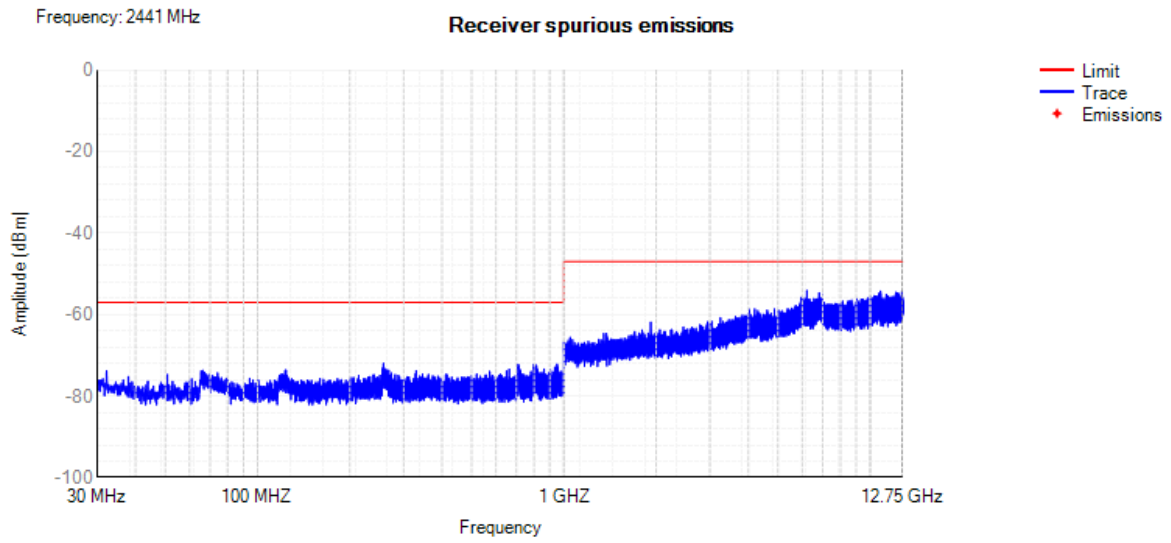

Rx. Spurious NVNT 2-DH5 2480MHz

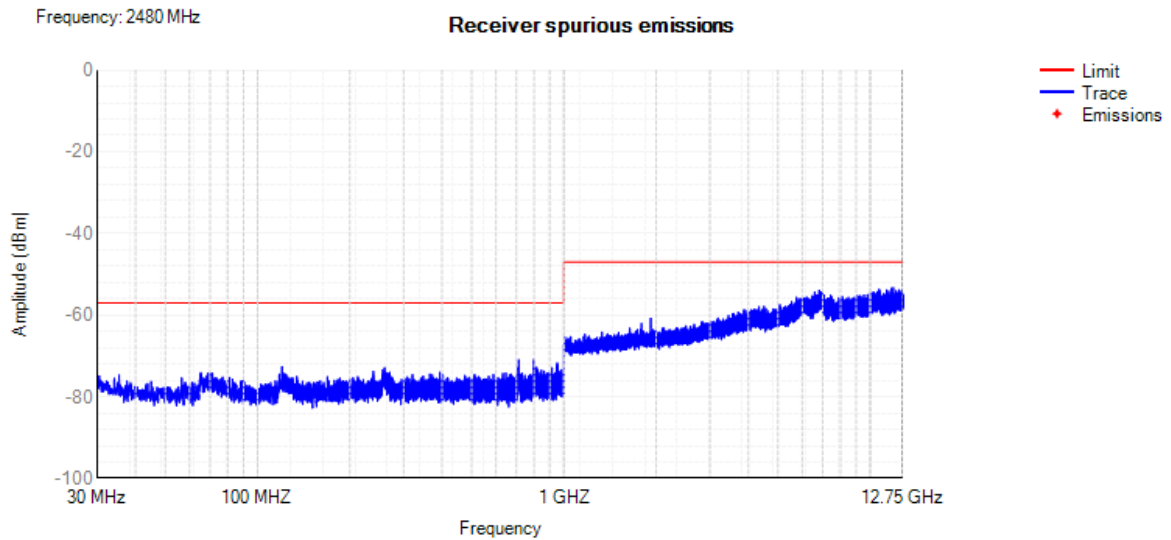

11.9 Hopping Sequence

Condition	Mode	Hopping Number	Limit	Band Allocation (%)	Limit Band Allocation (%)	Verdict
NVNT	1-DH5	79	15	95.4	70	Pass

Hopping Seq. NVNT 1-DH5 2441MHz

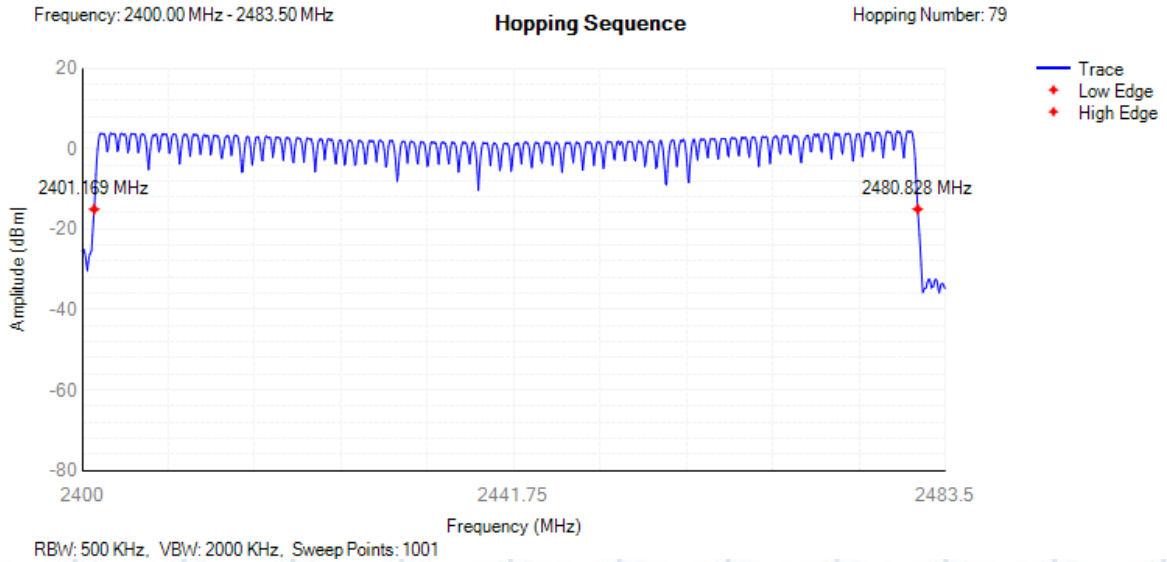

11.10 Transmitter unwanted emissions in the out-of-band domain

Condition	Mode	Frequency (MHz)	OOB Frequency (MHz)	Level (dBm/MHz)	Limit (dBm/MHz)	Verdict
NVNT	1-DH5	2480	2399.5	-61.99	-10	Pass
NVNT	1-DH5	2480	2398.5	-62.73	-20	Pass
NVNT	1-DH5	2480	2484	-61.46	-10	Pass
NVNT	1-DH5	2480	2485	-61.64	-20	Pass
NVNT	2-DH5	2480	2399.5	-62.28	-10	Pass
NVNT	2-DH5	2480	2399.299	-62.71	-10	Pass
NVNT	2-DH5	2480	2398.299	-62.68	-20	Pass
NVNT	2-DH5	2480	2398.098	-62.63	-20	Pass
NVNT	2-DH5	2480	2484	-62.16	-10	Pass
NVNT	2-DH5	2480	2484.191	-53.34	-10	Pass
NVNT	2-DH5	2480	2485.191	-61.51	-20	Pass
NVNT	2-DH5	2480	2485.382	-61.91	-20	Pass

Tx. Emissions OOB NVNT 1-DH5 2480MHz

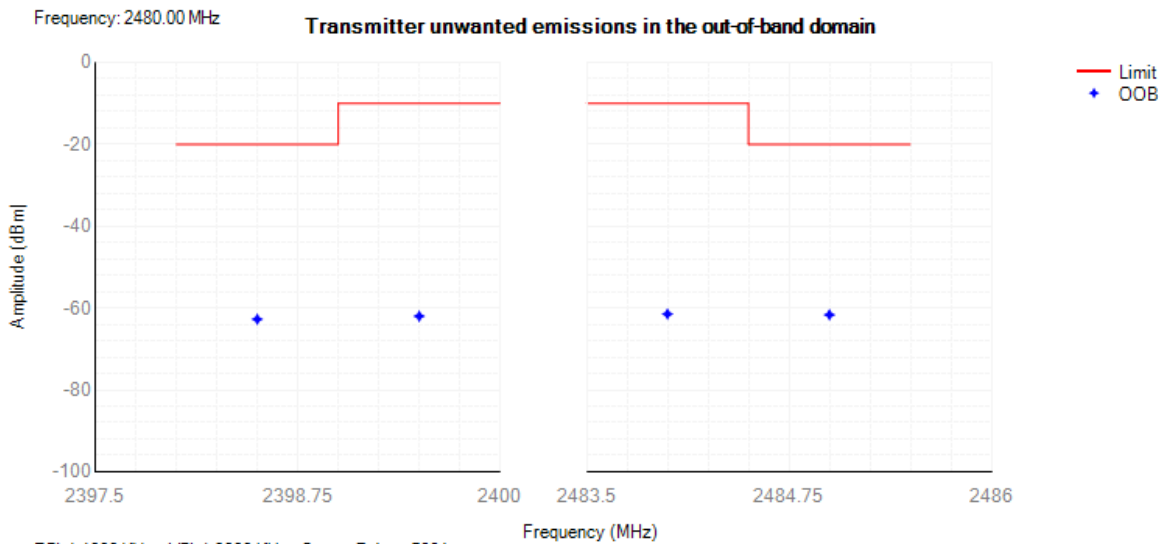

Tx. Emissions OOB NVNT 2-DH5 2480MHz

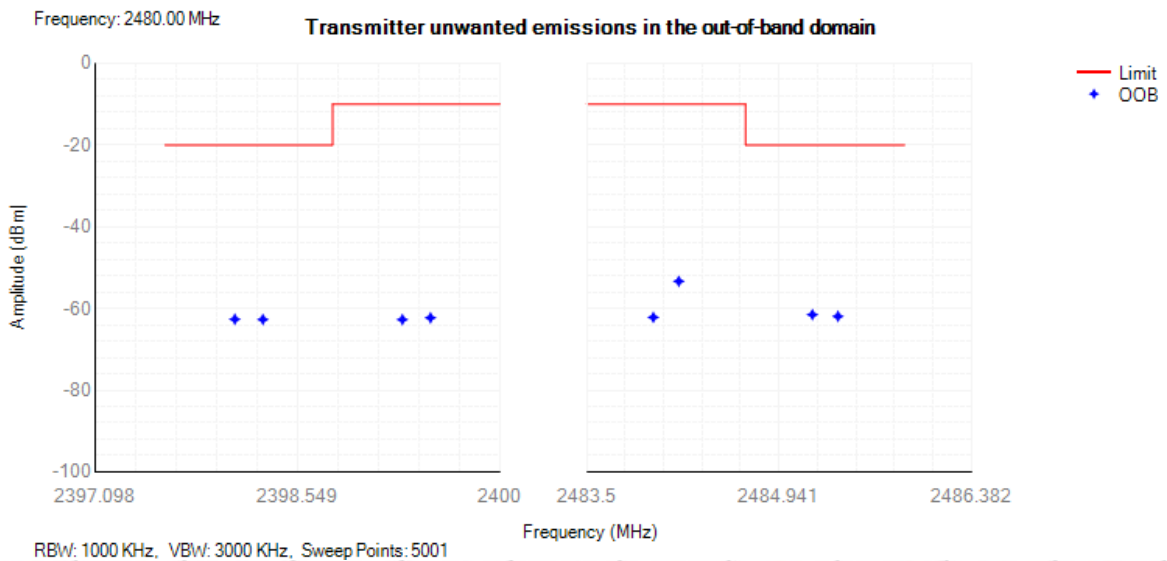

12. PHOTOGRAPHS OF THE TEST CONFIGURATION

SPURIOUS EMISSIONS MEASUREMENT PHOTOS

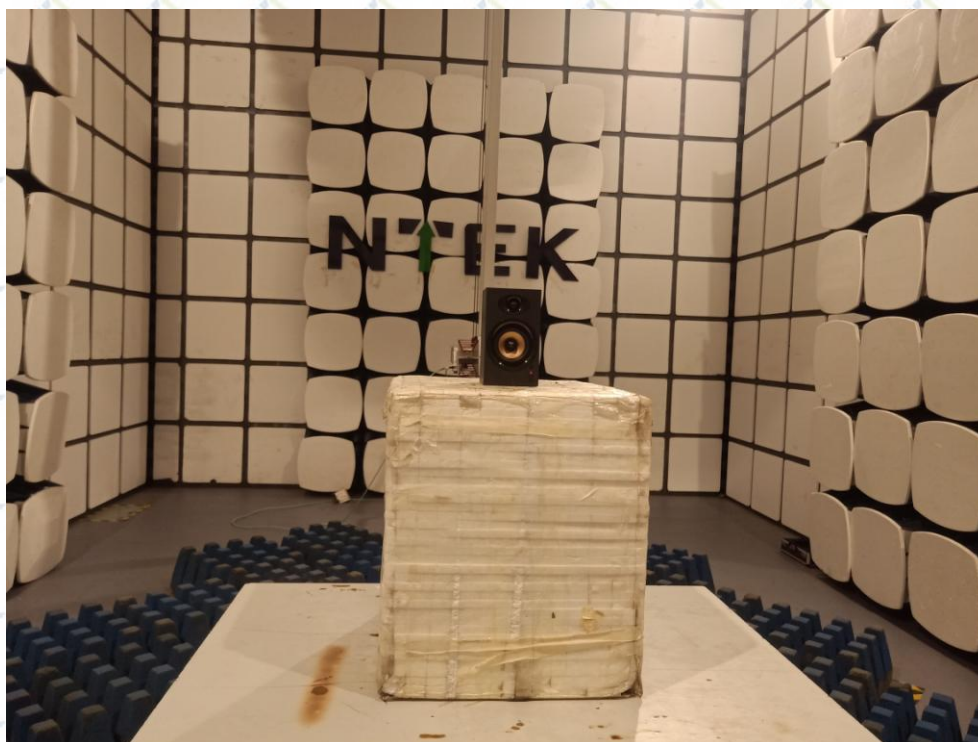
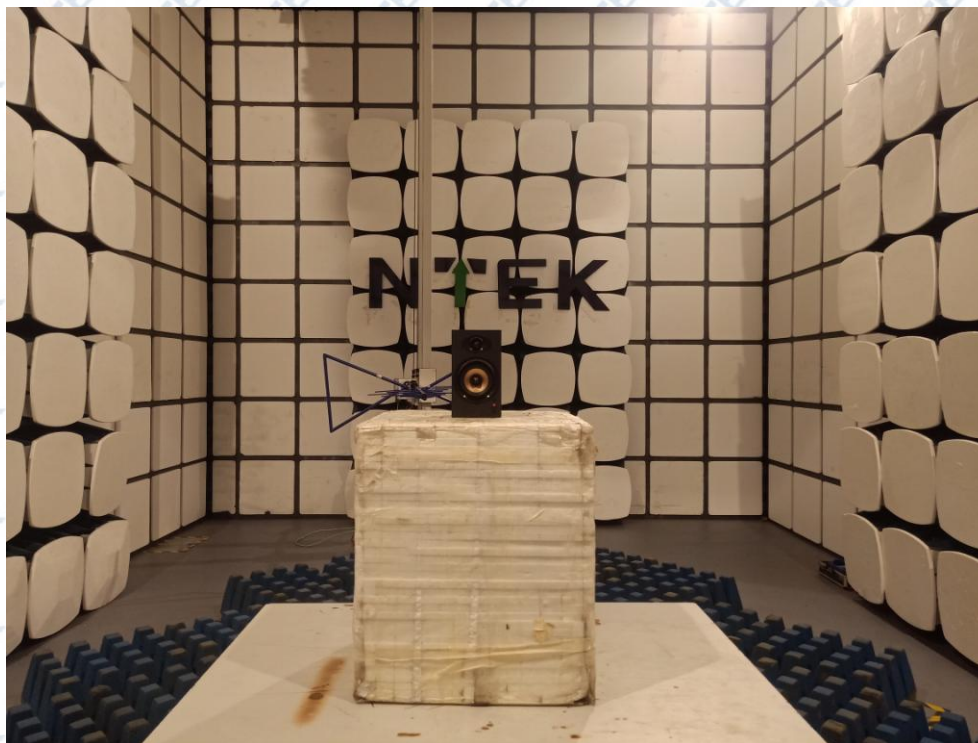

END OF REPORT