

EMC TEST REPORT

The device described below is tested by Dongguan Nore Testing Center Co., Ltd. to determine the maximum emission levels emanating from the device, the severe levels which the device can endure and E.U.T.'s performance criterion. The test results are contained in this test report. Dongguan Nore Testing Center Co., Ltd. is assumed of full responsibility for the accuracy and completeness of these tests.

Applicant : SHENZHEN FENDA TECHNOLOGY CO., LTD.
Address : Fenda Hi-Tech Park, Zhoushi Road, Shiyan Town, Baoan District, Shenzhen City, Guangdong, China
Manufacturer/Factory : SHENZHEN FENDA TECHNOLOGY CO., LTD.
Address : Fenda Hi-Tech Park, Zhoushi Road, Shiyan Town, Baoan District, Shenzhen City, Guangdong, China
E.U.T. : 2.0 Multimedia Speaker
Brand Name : F&D
Model No. : R40BT, R44BT, R50BT, R55BT, R27BT, R24BT, R25BT
(For model difference refer to section 2.1)
Measurement Standard : EN 55032: 2015
EN 61000-3-2: 2014, EN 61000-3-3: 2013
EN 55035: 2017
(IEC 61000-4-2: 2008, IEC 61000-4-3: 2006+A2: 2010,
IEC 61000-4-4: 2012, IEC 61000-4-5: 2014, IEC 61000-4-6: 2013,
IEC 61000-4-8: 2009, IEC 61000-4-11: 2004)
Date of Receiver : July 04, 2019
Date of Test : July 05, 2019 to July 16, 2019
Date of Report : July 17, 2019
This Test Report is Issued Under the Authority of :

Prepared by

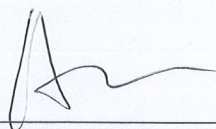

Alina Guo / Engineer

Approved & Authorized Signer



Ion Fan / Authorized Signatory

This report shows that the E.U.T. is technically compliant with the EN 55032, EN 61000-3-2, EN 61000-3-3, EN 55035. This report applies to above tested sample only and shall not be reproduced in part without written approval of Dongguan Nore Testing Center Co., Ltd.

TABLE OF CONTENT

1. SUMMARY OF TEST RESULTS.....	5
2. GENERAL INFORMATION	6
2.1 Details of E.U.T.	6
2.2 Description of Support Device	7
2.3 Block Diagram of Test Setup.....	7
2.4 Test Facility	8
2.5 Abnormalities from Standard Conditions.....	8
3. MEASURING DEVICES AND TEST EQUIPMENT	9
3.1 For Mains terminals Disturbance voltage test	9
3.2 For Radiated Emission Measurement.....	9
3.3 For Harmonic / Flicker Measurement.....	9
3.4 For Electrostatic Discharge Test	10
3.5 For RF Electromagnetic Field Immunity Test	10
3.6 For Electrical Fast Transient /Burst Immunity Test.....	10
3.7 For Surge Immunity Test.....	10
3.8 For Injected Currents Immunity Measurement	11
3.9 For Voltage Dips and Interruptions Measurement.....	11
4. MAINS TERMINAL DISTURBANCE VOLTAGE MEASUREMENT	12
4.1 Block Diagram of Test Setup.....	12
4.2 Limit of Mains Terminal Disturbance voltage measurement.....	12
4.3 Test Procedure.....	13
4.4 Operating Condition of E.U.T.	13
4.5 Mains Terminal Disturbance Voltage Test Results	13
5. RADIATED EMISSION MEASUREMENT	16
5.1 Block Diagram of Test.....	16
5.2 Limit of Radiated Emission Measurement	16
5.3 Test Procedure.....	17
5.4 Operating Condition of E.U.T.	17
5.5 Radiated Emission Measurement Result.....	17
6. HARMONIC CURRENT EMISSION TEST	20
6.1 Block Diagram of Test Setup.....	20
6.2 Limits of Harmonics current measurement	20
6.3 Test Procedure.....	21
6.4 Operating Condition of E.U.T.	21
6.5 Test Results	21
7. VOLTAGE FLUCTUATIONS & FLICKER TEST	22
7.1 Block Diagram of Test Setup.....	22
7.2 Limits of Voltage Fluctuations & Flicker Measurement.....	22
7.3 Test Procedure.....	22
7.4 Operating Condition of E.U.T.	23
7.5 Test Results	23
8. PERFORMANCE CRITERIA FOR IMMUNITY.....	24
9. ELECTROSTATIC DISCHARGE IMMUNITY TEST	26
9.1 Block Diagram of Test Setup.....	26
9.2 Test Standard and Severity Levels.....	26
9.3 Test Procedure.....	27
9.4 Test Results	27
10. RF FIELD STRENGTH SUSCEPTIBILITY TEST.....	30
10.1 Block Diagram of Test Setup.....	30
10.2 Test Standard and Severity Levels.....	31
10.3 Test Procedure.....	32
10.4 Test Results	32

11. ELECTRICAL FAST TRANSIENT/BURST IMMUNITY TEST.....	34
11.1 Block Diagram of Test Setup.....	34
11.2 Test Standard and Severity Levels.....	34
11.3 Test Procedure.....	35
11.4 Test Result.....	35
12. SURGE IMMUNITY TEST	37
12.1 Block Diagram of Test Setup.....	37
12.2 Test Standard and Severity Levels.....	37
12.3 Test Procedure.....	38
12.4 Test Result.....	38
13. INJECTED CURRENTS SUSCEPTIBILITY TEST.....	40
13.1 Block Diagram of Test Setup.....	40
13.2 Test Standard and Severity Levels.....	41
13.3 Test Procedure.....	41
13.4 Test Result.....	41
14. VOLTAGE DIPS AND INTERRUPTIONS TEST.....	43
14.1 Block Diagram of Test Setup.....	43
14.2 Test Standard and Severity Levels.....	43
14.3 Test Procedure.....	43
14.4 Test Result.....	44
15. PHOTOGRAPHS.....	46
15.1 Photo of Radiated Emission Measurement.....	46
15.2 Photo of Power Line Conducted Emission Measurement.....	46
15.3 Photo of Harmonic Current / Flicker Measurement.....	47
15.4 Photo of Electrostatic Discharge Immunity Measurement.....	47
15.5 Photo of RF Electromagnetic Field Immunity.....	48
15.6 Photo of Electrical Fast Transient /Burst /Surge /Voltage Dips	48
15.7 Photo of Injected Currents Immunity.....	49

APPENDIX I (Photos of the E.U.T.) (8 pages)

1. SUMMARY OF TEST RESULTS

The E.U.T. has been tested according to the following specifications:

EMISSION			
Standard	Test Type	Result	Remarks
EN 55032: 2015	Mains Terminal Disturbance Voltage Test	PASS	Uncertainty: 2.7dB
	Radiated Emission Test	PASS	Uncertainty: 3.4dB
EN 61000-3-2: 2014	Harmonic current emission	PASS	Meets the requirements.
EN 61000-3-3: 2013	Voltage fluctuations & flicker	PASS	Meets the requirements.
IMMUNITY(EN 55035: 2017)			
Standard	Test Type	Result	Remarks
IEC 61000-4-2: 2008	Electrostatic discharge immunity test	PASS	Meets the requirements of Performance Criterion B
IEC 61000-4-3: 2006+A2: 2010	Radio-frequency, electromagnetic field immunity test	PASS	Meets the requirements of Performance Criterion A
IEC 61000-4-4: 2012	Electrical fast transient/ burst immunity test	PASS	Meets the requirements of Performance Criterion B
IEC 61000-4-5: 2014	Surge immunity test	PASS	Meets the requirements of Performance Criterion B
IEC 61000-4-6: 2013	Injected Currents immunity test	PASS	Meets the requirements of Performance Criterion A
IEC 61000-4-8: 2009	Magnetic Field immunity test	N/A	The EUT do not contain magnetic field sensitive components.
IEC 61000-4-11: 2004	Voltage Dips and Interruptions	PASS	Meets the requirements of Performance Criterion B&C

2. GENERAL INFORMATION

2.1 Details of E.U.T.

E.U.T.	: 2.0 Multimedia Speaker
Main Model Name	: R40BT
Additional Model name	: R44BT, R50BT, R55BT, R27BT, R24BT, R25BT
Brand Name	: F&D
E.U.T. Type	: Class B
Operation Frequency	: Below108MHz (Except BT function)
Rating	: AC 100-240V 50/60Hz
Adapter	: N/A
Test Voltage	: AC 230V 50Hz, AC 110V 60Hz Only the worst case was recorded in the report.
Cable	: Audio Line: 1 to 2: 1.54m unshielded Speaker Line: 1.97m unshielded AC Mains: 1.78m unshielded
Hardware version	: V1.0
Software version	: V1.0
Description of model difference	: These models have the same circuit schematic, construction, PCB Layout and critical components. The difference is model number and color only due to trading purpose.
Note	: According to the model difference, all tests were performed on model R40BT.

2.2 Description of Support Device

Mobile Phone	:	Manufacturer: HUAWEI M/N: HWI-AL00 S/N: TAG-TL00C01B166
USB DISK	:	Manufacturer: Sony M/N: USB 3.0 8GB
DVD Player	:	Manufacturer: Pioneer M/N: DV-310NC-K S/N: 0JTL030411CN

2.3 Block Diagram of Test Setup

Block diagram of connection between the E.U.T. and simulators

Test mode: AUX IN, USB Playing



Test mode: Optical IN



2.4 Test Facility

Site Description

EMC Lab : Listed by CNAS, August 13, 2018
The certificate is valid until August 13, 2024
The Laboratory has been assessed and proved to
be in compliance with CNAS/CL01
The Certificate Registration Number is L5795.

Listed by A2LA, November 01, 2017
The certificate is valid until December 31, 2019
The Laboratory has been assessed and proved to
be in compliance with ISO17025
The Certificate Registration Number is 4429.01

Listed by FCC, November 06, 2017
The Designation Number is CN1214
Test Firm Registration Number: 907417

Listed by Industry Canada, June 08, 2017
The Certificate Registration Number. Is 46405-9743

Name of Firm : Dongguan Nore Testing Center Co., Ltd.
(Dongguan NTC Co., Ltd.)

Site Location : Building D, Gaosheng Science and Technology
Park, Hongtu Road, Nancheng District, Dongguan
City, Guangdong Province, China

2.5 Abnormalities from Standard Conditions

N/A

3. MEASURING DEVICES AND TEST EQUIPMENT

3.1 For Mains terminals Disturbance voltage test

Item	Equipment	Manufacturer	Model No.	Serial No.	Last Cal.	Cal. Interval
1.	Test Receiver	Rohde & Schwarz	ESCI	101152	Mar. 14, 2019	1 Year
2.	L.I.S.N	Rohde & Schwarz	ENV 216	101317	Mar. 14, 2019	1 Year
3.	L.I.S.N	Rohde & Schwarz	ESH2-Z5	893606/01 4	Mar. 14, 2019	1 Year
4.	RF Switching Unit	Compliance Direction Systems Inc.	RSU-M2	38311	Mar.14, 2019	1 Year
5.	Test Software	EZ	EZ_EM	N/A	N/A	N/A

3.2 For Radiated Emission Measurement

Item	Equipment	Manufacturer	Model No.	Serial No.	Last Cal.	Cal. Interval
1.	Test Receiver	Rohde & Schwarz	ESCI7	100837	Mar. 14, 2019	1 Year
2.	Antenna	Schwarzbeck	VULB9162	9162-010	Mar. 23, 2019	1 Year
3.	Positioning Controller	UC	UC 3000	N/A	N/A	N/A
4.	Color Monitor	SUNSCO	SP-140A	N/A	N/A	N/A
5.	Single Phase Power Line Filter	SAEMC	PF201A-32	110210	N/A	N/A
6.	3 Phase Power Line Filter	SAEMC	PF401A-200	110318	N/A	N/A
7.	DC Power Filter	SAEMC	PF301A-200	110245	N/A	N/A
8.	Spectrum Analyzer	Rohde & Schwarz	FSU26	200409/026	Mar. 14, 2019	1 Year
9.	Horn Antenna	COM-Power	AH-118	071078	Mar. 23, 2019	1 Year
10.	Loop Antenna	Schwarzbeck	FMZB 1513	1513-272	Apr. 24, 2019	1 Year
11.	Pre-Amplifier	HP	HP 8449B	3008A00964	Mar. 14, 2019	1 Year
12.	Pre-Amplifier	HP	HP 8447D	1145A00203	Mar. 14, 2019	1 Year
13.	Test Software	EZ	EZ_EM	N/A	N/A	N/A

3.3 For Harmonic / Flicker Measurement

Item	Equipment	Manufacturer	Model No.	Serial No.	Last Cal.	Cal. Interval
1.	Power Frequency Analyser	California Instruments	PACS-1	72846	Mar. 14, 2019	1 Year
2.	5KVA AC Power Source	California Instruments	500liX	60137	Mar. 14, 2019	1 Year
3.	Software	California Instruments	CTS30	N/A	N/A	N/A

3.4 For Electrostatic Discharge Test

Item	Equipment	Manufacturer	Model No.	Serial No.	Last Cal.	Cal. Interval
1.	ESD Tester	TESEQ	NSG 437	432	Mar. 23, 2019	1 Year

3.5 For RF Electromagnetic Field Immunity Test

Item	Equipment	Manufacturer	Model No.	Serial No.	Last Cal.	Cal. Interval
1.	Signal Generator	Agilent	N5181A	MY470701 60	Apr. 24, 2019	1 Year
2.	RF Switch	SKET	N/A	N/A	N/A	N/A
3.	Power Amplifier	SKET	HAP801000 M_250W	201804008	N/A	N/A
4.	Power Amplifier	SKET	HAP0103G_ 75W	201804009	N/A	N/A
5.	Power Amplifier	SKET	HAP0306G_ 50W	201804010	N/A	N/A
6.	Power Meter	Agilent	E4419B	GB402014 69	Apr.24,2019	1 Year
7.	Power Sensor	Agilent	E9300A	MY414989 19	Apr.24,2019	1 Year
8.	Power Sensor	Agilent	E9300A	US392112 59	Apr.24,2019	1 Year
9.	E-Field Probe	Narda	EP-601	N/A	Apr.24,2019	1 Year
10.	Antenna	Schwarzbeck	STLP 9129	9129071	Apr.24,2018	2 Year
11.	Audio Analyzer	Rohde & Schwarz	UPV	100894	Mar. 23, 2019	1 Year
12.	Chamber	Chengyu	7*5*3.5m	N/A	Mar.26,2018	2 Year
13.	Test Software	SKET	SKIT_RS	N/A	N/A	N/A

3.6 For Electrical Fast Transient /Burst Immunity Test

Item	Equipment	Manufacturer	Model No.	Serial No.	Last Cal.	Cal. Interval
1.	Burst Tester	EM TEST	UCS 500N	V1104108683	Mar. 14, 2019	1 Year
2.	Coupling Clamp	EM TEST	HFK	0311-94	Mar. 14, 2019	1 Year
3.	Test Soft	EM TEST	lec. control	N/A	N/A	N/A

3.7 For Surge Immunity Test

Item	Equipment	Manufacturer	Model No.	Serial No.	Last Cal.	Cal. Interval
1.	Surge Tester	EM TEST	UCS 500N	V1104108683	Mar. 14, 2019	1 Year
2.	Test Soft	EM TEST	lec. control	N/A	N/A	N/A

3.8 For Injected Currents Immunity Measurement

Item	Equipment	Manufacturer	Model No.	Serial No.	Last Cal.	Cal. Interval
1.	Signal Generator	IFR	2023A	N/A	Mar. 14, 2019	1 Year
2.	Power Amplifier	SCHAFFNER	CBA9425	1022	Mar. 14, 2019	1 Year
3.	6dB 50Watt Attenuator	SCHAFFNER	ATN6025	N/A	Mar. 14, 2019	1 Year
4.	CDN	Lioncel	CDN-M3-16	0170708	Mar. 14, 2019	1 Year
5.	CDN	Lioncel	CDN-M2-16	0170723	Mar. 14, 2019	1 Year
6.	Directional Coupler	SCHAFFNER	255	19184	Mar. 14, 2019	1 Year
7.	Dips Modulator	EM TEST	V4780S2	0111-11	Mar. 14, 2019	1 Year
8.	Audio Analyzer	Rohde & Schwarz	UPV	100894	Mar. 23, 2019	1 Year
9.	Test Software	EZ	EZ_CS	N/A	N/A	N/A

3.9 For Voltage Dips and Interruptions Measurement

Item	Equipment	Manufacturer	Model No.	Serial No.	Last Cal.	Cal. Interval
1.	Dips Tester	EM TEST	UCS500N	V1104108683	Mar. 14, 2019	1 Year
2.	Test Soft	EM TEST	lec.control	N/A	N/A	N/A
3.	Dips Modulator	EM TEST	V4780S2	0111-11	Mar. 14, 2019	1 Year

4. MAINS TERMINAL DISTURBANCE VOLTAGE MEASUREMENT

4.1 Block Diagram of Test Setup

4.1.1 Conducted Disturbance at the mains ports

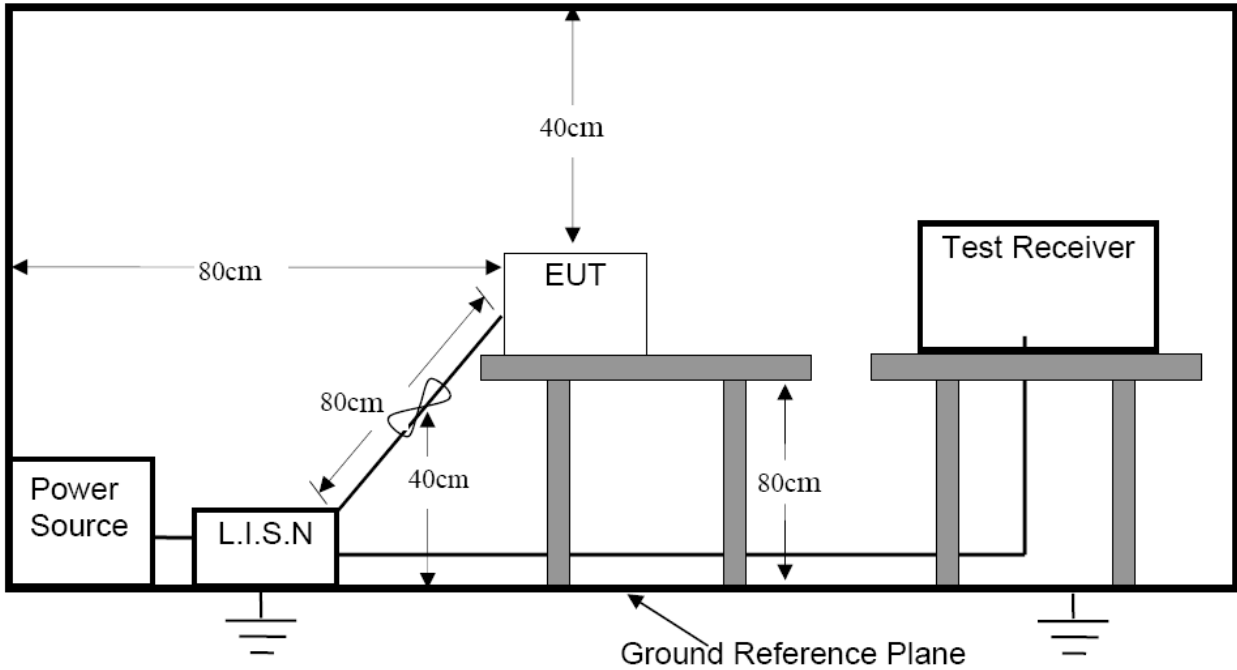

4.2 Limit of Mains Terminal Disturbance voltage measurement

Test Standard: EN 55032

Limits for conducted disturbance at the mains ports.

Frequency range (MHz)	Limits (dB(uV))	
	Quasi-peak	Average
0.15 to 0.5	66 to 56*	56 to 46*
0.5 to 5	56	46
5 to 30	60	50

*Decreasing linearly with the logarithm of the frequency.

- Note:
1. The lower limit shall apply at the transition frequencies.
 2. The limit decreases linearly with the logarithm of the frequency in the range 0.15 MHz to 0.5 MHz.

4.3 Test Procedure

The E.U.T. is put on the 0.8 m high table and connected to the AC mains through a Artificial Mains Network (AMN). This provided a 50ohm coupling impedance for the tested equipments. Both sides of AC line are checked to find out the maximum conducted emission levels according to the EN 55032 regulations during conducted emission test.

The bandwidth of the test receiver (R&S Test Receiver ESCI) is set at 9 KHz.

4.4 Operating Condition of E.U.T.

4.4.1 Setup the E.U.T. and simulators as shown in Section 2.3.

4.4.2 Turn on the power of all equipments.

4.4.3 Let the E.U.T. work in test modes (AUX IN, Optical IN, USB Playing) and test it.

4.5 Mains Terminal Disturbance Voltage Test Results

PASS.

Please refer to the following pages of the worst case: USB Playing.



Dongguan NTC Co., Ltd.
 Tel: +86-769-22022444 Fax: +86-769-22022799
 Web: [Http://www.ntc-c.com](http://www.ntc-c.com)

Conducted Emission Measurement

File :R40BT Data :#1 Date: 2019/7/6 Time: 10:07:06

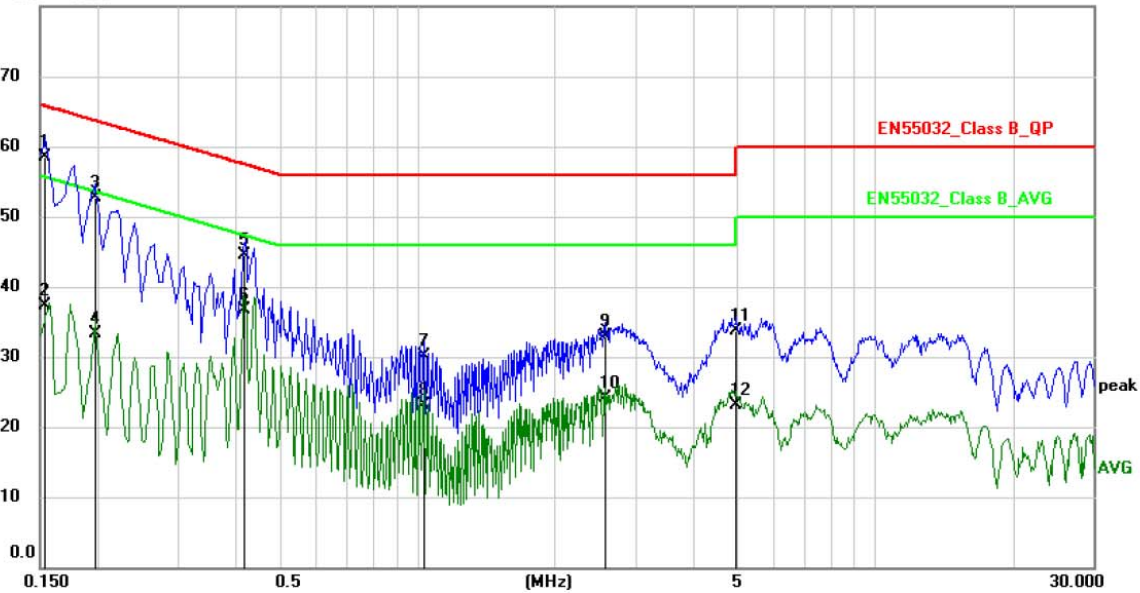

Site: Phase: **L1** Temperature: 26
 Limit: EN55032_Class B_QP Power: AC230V/50Hz Humidity: 60 %
 EUT: 2.0 Multimedia Speaker
 M/N: R40BT
 Mode: USB Playing
 Note:

No.	Mk.	Freq. MHz	Reading Level dBuV	Correct Factor dB	Measure- ment dBuV	Limit dBuV	Over dB	Detector	Comment
1	*	0.1539	47.99	10.61	58.60	65.79	-7.19	QP	
2		0.1539	26.79	10.61	37.40	55.79	-18.39	AVG	
3		0.1980	42.19	10.61	52.80	63.69	-10.89	QP	
4		0.1980	22.69	10.61	33.30	53.69	-20.39	AVG	
5		0.4180	33.98	10.62	44.60	57.49	-12.89	QP	
6		0.4180	26.18	10.62	36.80	47.49	-10.69	AVG	
7		1.0339	19.55	10.65	30.20	56.00	-25.80	QP	
8		1.0339	12.55	10.65	23.20	46.00	-22.80	AVG	
9		2.5779	22.25	10.65	32.90	56.00	-23.10	QP	
10		2.5779	13.45	10.65	24.10	46.00	-21.90	AVG	
11		4.9778	23.04	10.66	33.70	56.00	-22.30	QP	
12		4.9778	12.44	10.66	23.10	46.00	-22.90	AVG	

*:Maximum data x:Over limit !:over margin

(Reference Only)



Dongguan NTC Co., Ltd.
 Tel: +86-769-22022444 Fax: +86-769-22022799
 Web: [Http://www.ntc-c.com](http://www.ntc-c.com)

Conducted Emission Measurement

File :R40BT Data :#2 Date: 2019/7/6 Time: 10:14:08

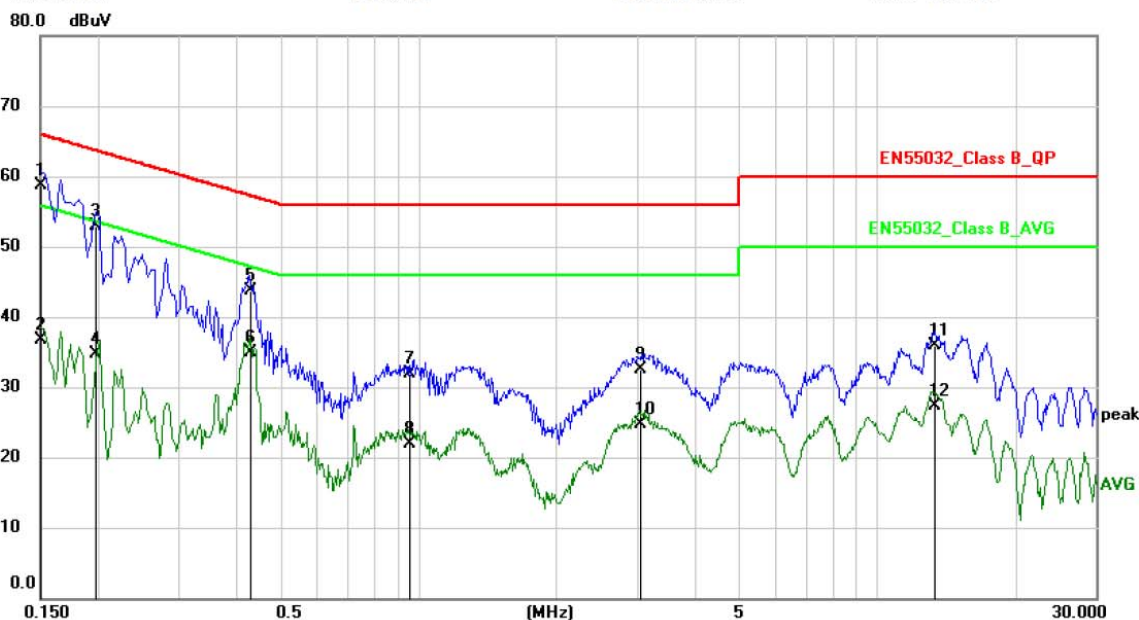

Site: Phase: **N** Temperature: 26
 Limit: EN55032_Class B_QP Power: AC230V/50Hz Humidity: 60 %
 EUT: 2.0 Multimedia Speaker
 M/N: R40BT
 Mode: USB Playing
 Note:

No.	Mk.	Freq.	Reading Level	Correct Factor	Measurement	Limit	Over	Detector	Comment
		MHz	dBuV	dB	dBuV	dBuV	dB		
1	*	0.1500	48.19	10.61	58.80	66.00	-7.20	QP	
2		0.1500	26.19	10.61	36.80	56.00	-19.20	AVG	
3		0.1980	42.29	10.61	52.90	63.69	-10.79	QP	
4		0.1980	24.19	10.61	34.80	53.69	-18.89	AVG	
5		0.4300	33.18	10.62	43.80	57.25	-13.45	QP	
6		0.4300	24.28	10.62	34.90	47.25	-12.35	AVG	
7		0.9577	21.25	10.65	31.90	56.00	-24.10	QP	
8		0.9577	11.25	10.65	21.90	46.00	-24.10	AVG	
9		3.0300	21.95	10.65	32.60	56.00	-23.40	QP	
10		3.0300	14.05	10.65	24.70	46.00	-21.30	AVG	
11		13.2736	25.23	10.67	35.90	60.00	-24.10	QP	
12		13.2736	16.73	10.67	27.40	50.00	-22.60	AVG	

*:Maximum data x:Over limit !:over margin

(Reference Only)

5. RADIATED EMISSION MEASUREMENT

5.1 Block Diagram of Test

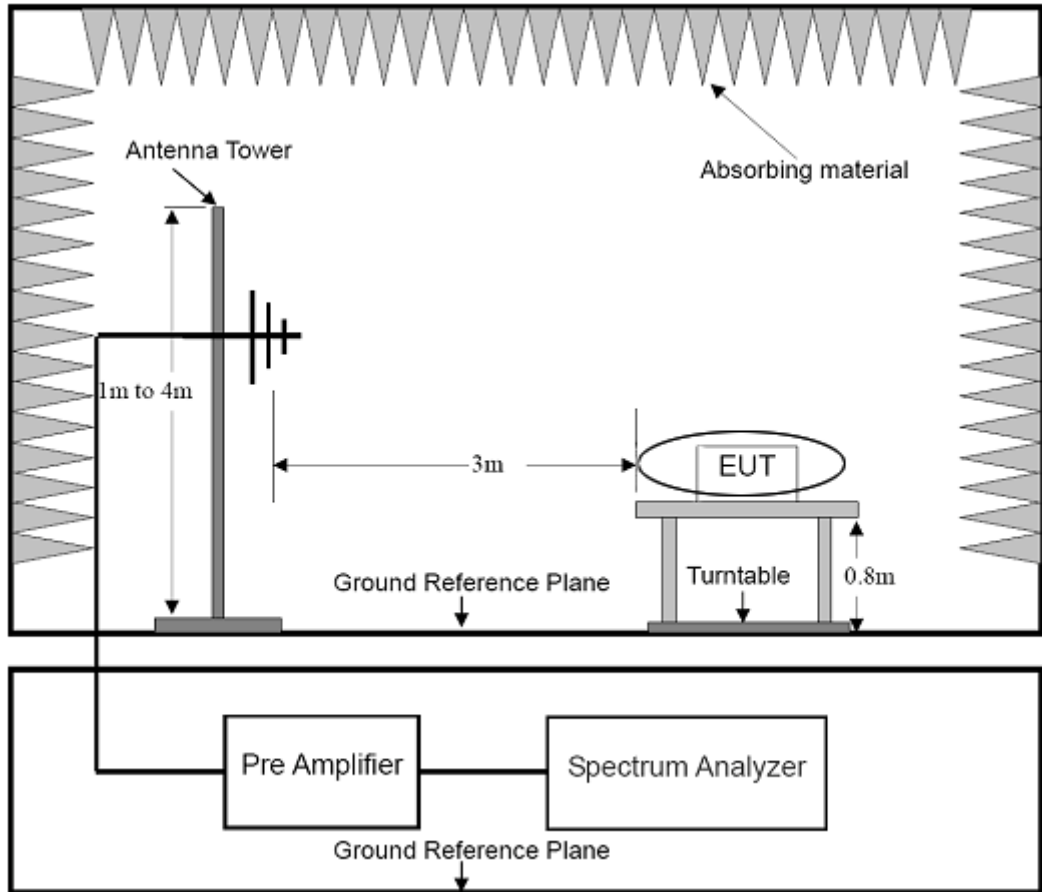

5.2 Limit of Radiated Emission Measurement

Test Standard: EN 55032

Limits for radiated disturbance of class B at a measuring distance of 3m
 Limits below 1GHz

Frequency range MHz	Quasi-peak limits dB(uV/m)
30 to 230	40
230 to 1000	47

Note 1 The lower limit shall apply at the transition frequency.

Note 2 Additional provisions may be required for cases where interference occurs.

Limits above 1GHz

Frequency (GHz)	Average Limit dB(uV/m)	Peak Limit dB(uV/m)
1 ~ 3	50	70
3 ~ 6	54	74

Note: The highest internal source of an EUT is defined as the highest frequency generated or used within the EUT or on which the EUT operates or tunes.

- (1) If the highest frequency of the internal sources of the EUT is less than 108MHz, the measurement shall only be made up to 1GHz.
- (2) If the highest frequency of the internal sources of the EUT is between 108MHz and 500MHz, the measurement shall only be made up to 2GHz.
- (3) If the highest frequency of the internal sources of the EUT is between 500MHz and 1GHz, the measurement shall only be made up to 5GHz.
- (4) If the highest frequency of the internal sources of the EUT is above 1GHz, the measurement shall be made up to 5 times the highest frequency or 6GHz, whichever is less.

5.3 Test Procedure

E.U.T. and its simulators are placed on a turntable, which is 0.8 meter high above ground. The turntable can rotate 360 degrees to determine the position of the maximum emission level. E.U.T. is set 3.0 meters away from the receiving antenna, which is mounted on a antenna tower. The antenna can be moved up and down between 1.0 meter and 4 meters to find out the maximum emission level. Broadband antenna (calibrated bilog antenna) is used as receiving antenna. Both horizontal and vertical polarization of the antenna is set on measurement. In order to find the maximum emission levels, all of the interface cables must be manipulated according to EN 55032 on radiated emission measurement.

Below 1GHz, the bandwidth of the EMI test is set at 120 KHz.

The frequency range from 30 MHz to 1 GHz is checked.

5.4 Operating Condition of E.U.T.

5.4.1 Setup the E.U.T. and simulators as shown in Section 2.3.

5.4.2 Turn on the power of all equipments.

5.4.3 Let the E.U.T. work in test modes (AUX IN, Optical IN, USB Playing) and test it.

5.5 Radiated Emission Measurement Result

PASS.

Please refer to the following pages of the worst case: USB Playing.



Dongguan NTC Co., Ltd.
 Tel:+86-769-22022444 Fax:+86-769-22022799
 Web: [Http://www.ntc-c.com](http://www.ntc-c.com)

Radiated Emission Measurement

File :R40BT Data :#6 Date: 2019/7/8 Time: 22:13:53

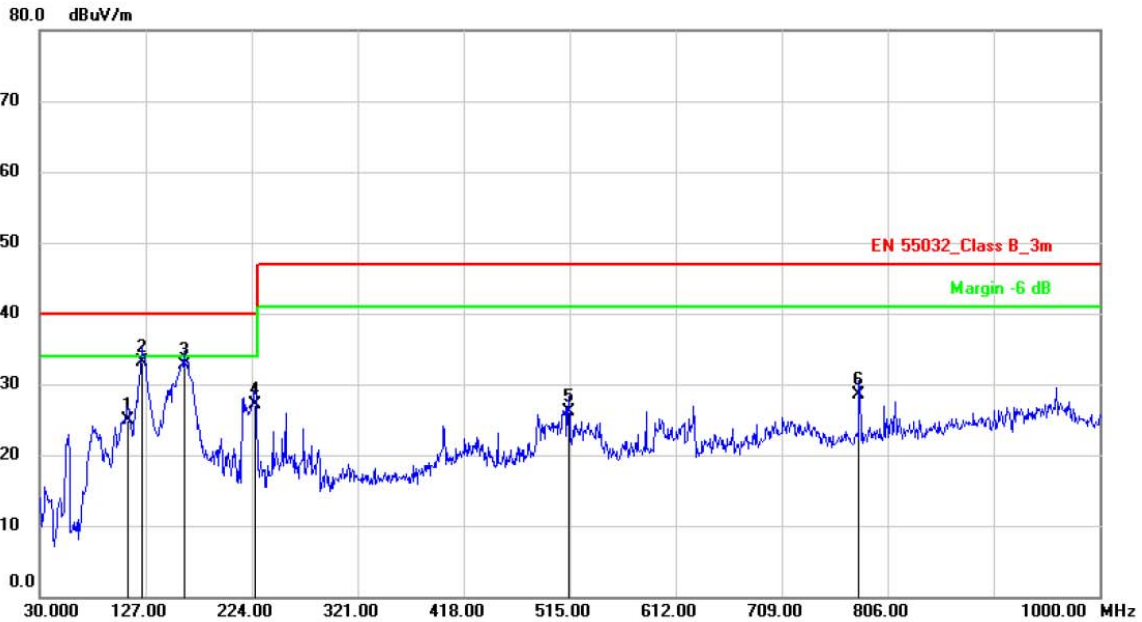

Site: 3m Chamber Polarization: **Horizontal** Temperature: 26
 Limit: EN 55032_Class B_3m Power: AC230V/50Hz Humidity: 47 %
 EUT: 2.0 Multimedia Speaker Distance: 3m
 M/N: R40BT
 Mode: USB Playing
 Note:

No.	Mk.	Freq. MHz	Reading Level dBuV	Correct Factor dB/m	Measure- ment dBuV/m	Limit dBuV/m	Over dB	Detector	Antenna Height cm	Table Degree degree	Comment
1		110.5100	37.16	-12.26	24.90	40.00	-15.10	QP			
2	*	123.1200	47.60	-14.40	33.20	40.00	-6.80	QP			
3		161.9200	47.78	-15.08	32.70	40.00	-7.30	QP			
4		226.9100	39.71	-12.61	27.10	40.00	-12.90	QP			
5		514.0300	32.94	-6.74	26.20	47.00	-20.80	QP			
6		779.8100	30.70	-2.20	28.50	47.00	-18.50	QP			

*:Maximum data x:Over limit !:over margin

(Reference Only)



Dongguan NTC Co., Ltd.
 Tel:+86-769-22022444 Fax:+86-769-22022799
 Web: [Http://www.ntc-c.com](http://www.ntc-c.com)

Radiated Emission Measurement

File :R40BT Data :#5 Date: 2019/7/8 Time: 22:06:42

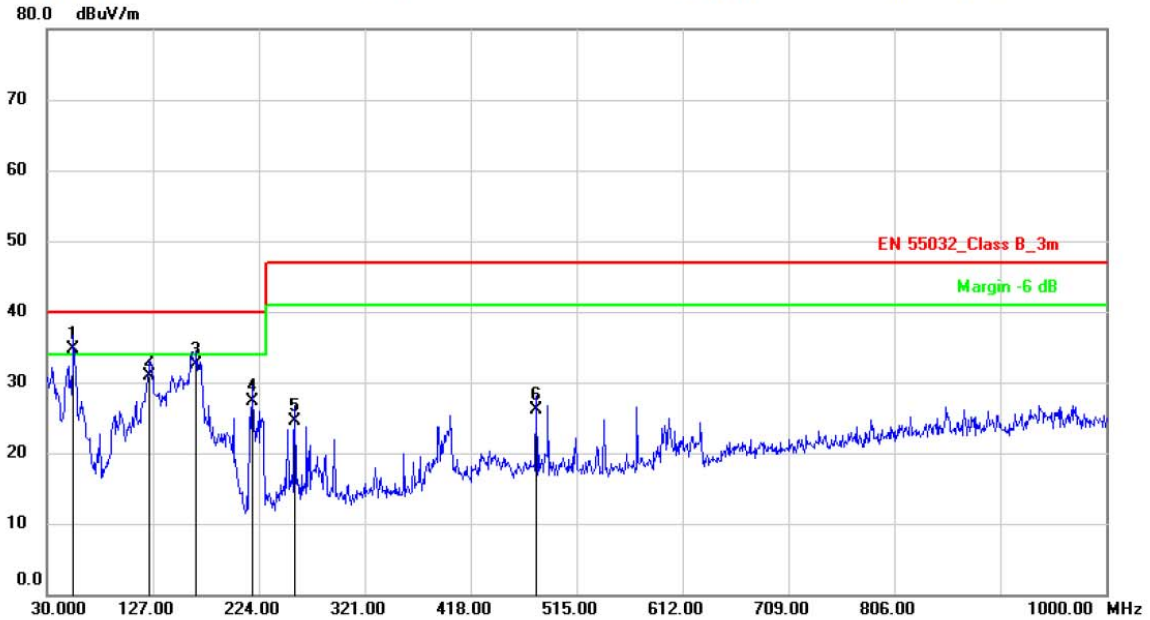

Site: 3m Chamber Polarization: *Vertical* Temperature: 26
 Limit: EN 55032_Class B_3m Power: AC230V/50Hz Humidity: 47 %
 EUT: 2.0 Multimedia Speaker Distance: 3m
 M/N: R40BT
 Mode: USB Playing
 Note:

No.	Mk.	Freq.	Reading Level	Correct Factor	Measurement	Limit	Over	Antenna Height	Table Degree	
		MHz	dBuV	dB/m	dBuV/m	dBuV/m	dB	cm	degree	Comment
1	*	54.2500	48.34	-13.64	34.70	40.00	-5.30	QP		
2		124.0900	48.51	-17.51	31.00	40.00	-9.00	QP		
3		166.7700	50.42	-17.92	32.50	40.00	-7.50	QP		
4		218.1800	43.42	-16.02	27.40	40.00	-12.60	QP		
5		256.9800	38.11	-13.51	24.60	47.00	-22.40	QP		
6		478.1400	35.35	-9.25	26.10	47.00	-20.90	QP		

*:Maximum data x:Over limit !:over margin

<Reference Only

6. HARMONIC CURRENT EMISSION TEST

6.1 Block Diagram of Test Setup

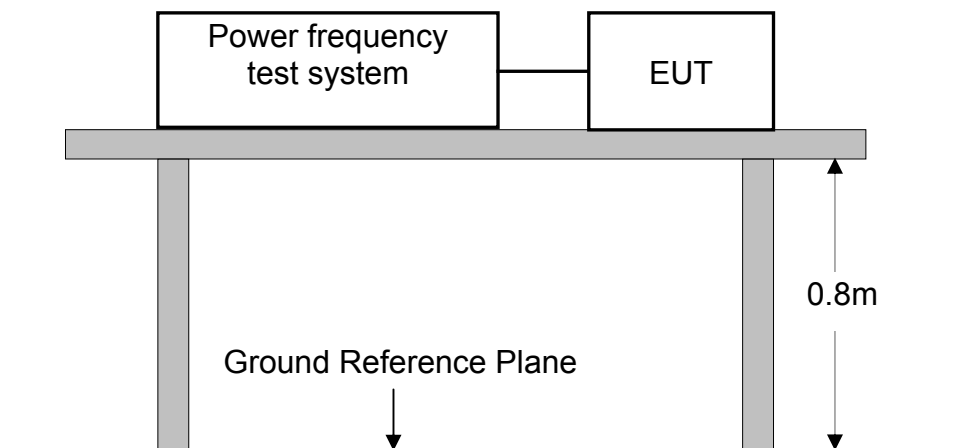

6.2 Limits of Harmonics current measurement

Test Standard: EN 61000-3-2

Limits for Class A equipment	
Harmonics Order n	Max. permissible harmonics current A
Odd harmonics	
3	2.30
5	1.14
7	0.77
9	0.40
11	0.33
13	0.21
$15 \leq n \leq 39$	$0.15 \times 15/n$
Even harmonics	
2	1.08
4	0.43
6	0.30
$8 \leq n \leq 40$	$0.23 \times 8/n$

For the following categories of equipment limits are not specified in this edition of the standard.

Note: Equipment with a rated power of 75W or less, other than lighting equipment.

6.3 Test Procedure

The E.U.T. was put on the top of a wooden table 0.8m above the ground and operated to produce the maximum harmonic components under normal operating conditions for each successive harmonic component in turn.

The E.U.T. is classified as follows:

Class A:

Balanced three-phase equipment, Household appliances excluding equipment as Class D, Tools excluding portable tools, Dimmers for incandescent lamps, audio equipment ,equipment not specified in one of the three other classes.

Class B:

Portable tools; Arc welding equipment which is not professional equipment.

Class C:

Lighting equipment.

Class D:

Equipment having a specified power less than or equal to 600W of the following types: Personal computers and personal computer monitors and television receivers.

6.4 Operating Condition of E.U.T.

6.4.1 Setup the E.U.T. and simulators as shown in Section 2.3.

6.4.2 Turn on the power of all equipments.

6.4.3 Let the E.U.T. work in test modes (AUX IN, Optical IN, USB Playing) and test it.

6.5 Test Results

PASS.

According to clause 7 of EN 61000-3-2, equipment with a rated power of 75W or less, no limits apply. It is considered to meet the requirements of the standard.

7. VOLTAGE FLUCTUATIONS & FLICKER TEST

7.1 Block Diagram of Test Setup

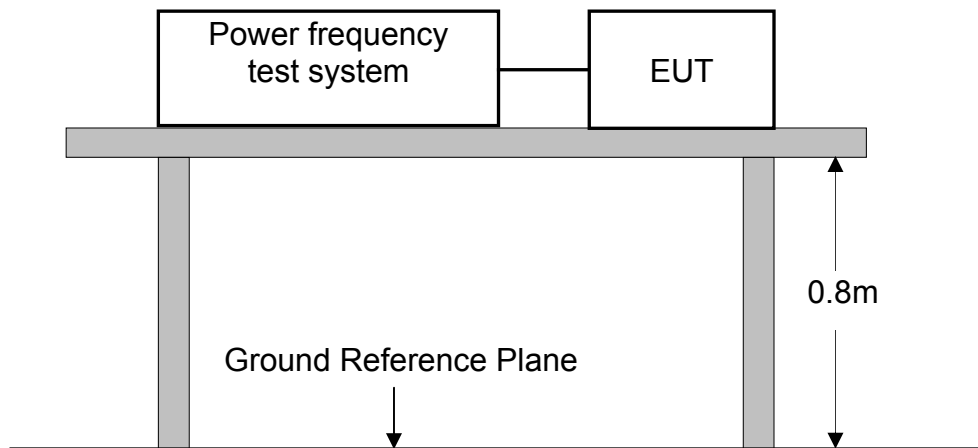

7.2 Limits of Voltage Fluctuations & Flicker Measurement

Test Standard: EN 61000-3-3

Test Item	Limit
P_{st} (Short-term flicker indicator.)	1.0
P_{lt} (Long-term flicker indicator.)	0.65
$T_{d(t)}$ (ms) (Maximum time that $d(t)$ exceeds 3.3%)	500
d_{max} (%) (Maximum relative voltage change.)	4
d_c (%) (Relative steady-state voltage change)	3.3

7.3 Test Procedure

The E.U.T. was put on the top of a wooden table 0.8m above the ground and operated to produce the most unfavorable sequence of voltage changes under normal operating conditions.

7.4 Operating Condition of E.U.T.

7.4.1 Setup the E.U.T. and simulators as shown in Section 2.3.

7.4.2 Turn on the power of all equipments.

7.4.3 Let the E.U.T. work in test modes (AUX IN, Optical IN, USB Playing) and test it.

7.5 Test Results

PASS.

Please refer to the following page of the worst case: AUX IN.

Flicker Test Summary per EN/IEC61000-3-3 (Run time)

EUT: 2.0 Multimedia Speaker
 Test category: All parameters (European limits)
 Test date: 2019/7/9
 Test duration (min): 10
 Comment: AUX IN
 Customer: FENDA
 M/N: R40BT
 Test Result: Pass

Tested by: Sean
 Test Margin: 100
 End time: 9:49:08
 Start time: 9:38:47
 Data file name: F-000097.cts_data

Status: Test Completed

Pst_i and limit line

European Limits

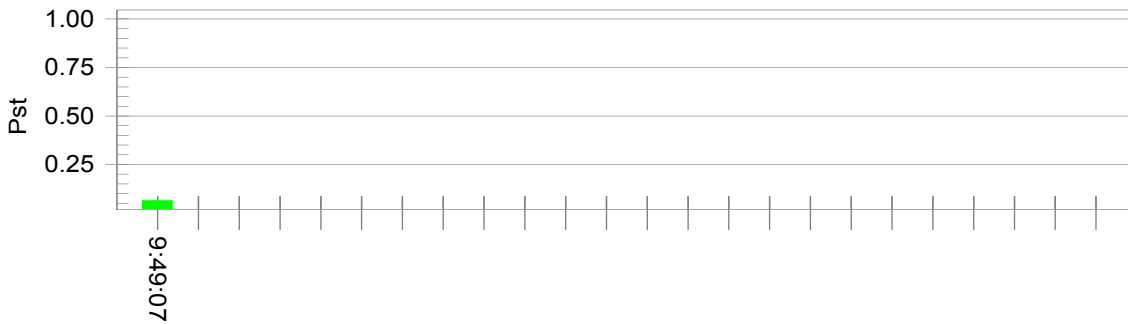

Plt and limit line

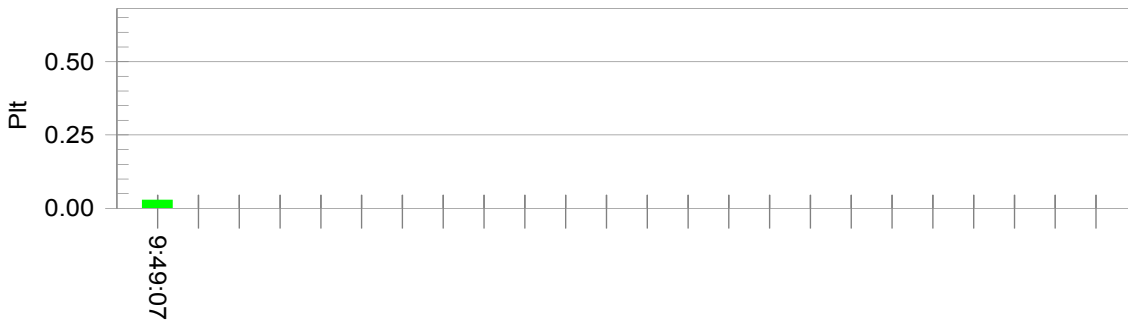

Parameter values recorded during the test:

Vrms at the end of test (Volt):	230.48		
Highest dt (%):	0.00	Test limit (%):	3.30 Pass
Time(mS) > dt:	0.0	Test limit (mS):	500.0 Pass
Highest dc (%):	0.00	Test limit (%):	3.30 Pass
Highest dmax (%):	0.00	Test limit (%):	4.00 Pass
Highest Pst (10 min. period):	0.064	Test limit:	1.000 Pass
Highest Plt (2 hr. period):	0.028	Test limit:	0.650 Pass

8. PERFORMANCE CRITERIA FOR IMMUNITY

The performance criteria are referred to the test standard: **EN 55035**

Performance Criteria A

The equipment shall continue to operate as intended without operator intervention. No degradation of performance, loss of function or change of operating state is allowed below a performance level specified by the manufacturer when the equipment is used as intended. The performance level may be replaced by a permissible loss of performance. If the minimum performance level or the permissible performance loss is not specified by the manufacturer, then either of these may be derived from the product description and documentation, and by what the user may reasonably expect from the equipment if used as intended.

Performance Criteria B

During the application of the disturbance, degradation of performance is allowed. However, no unintended change of actual operating state or stored data is allowed to persist after the test.

After the test, the equipment shall continue to operate as intended without operator intervention; no degradation of performance or loss of function is allowed, below a performance level specified by the manufacturer, when the equipment is used as intended. The performance level may be replaced by a permissible loss of performance.

If the minimum performance level (or the permissible performance loss), or recovery time, is not specified by the manufacturer, then either of these may be derived from the product description and documentation, and by what the user may reasonably expect from the equipment if used as intended.

Performance Criteria C

Loss of function is allowed, provided the function is self-recoverable, or can be restored by the operation of the controls by the user in accordance with the manufacturer's instructions. A reboot or re-start operation is allowed.

Information stored in non-volatile memory, or protected by a battery backup, shall not be lost.

9. ELECTROSTATIC DISCHARGE IMMUNITY TEST

9.1 Block Diagram of Test Setup

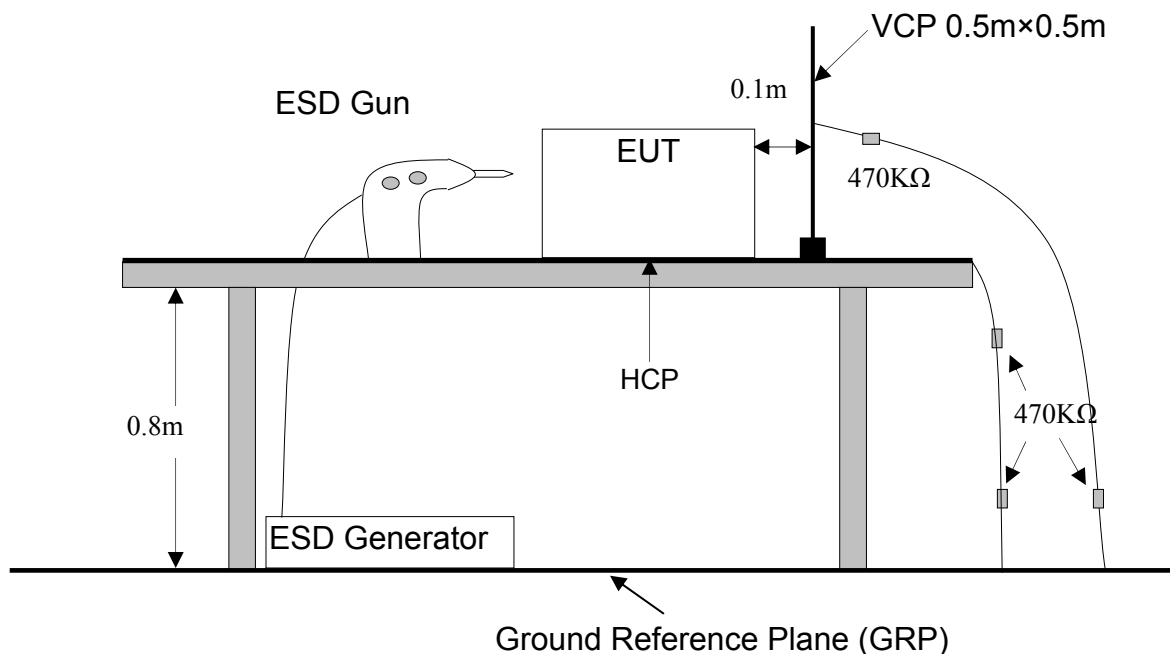

9.2 Test Standard and Severity Levels

9.2.1 Test Standard:

EN 55035

(IEC 61000-4-2 Air Discharge: Severity Level: 1, 2, 3;

Contact Discharge: Level:1, 2)

9.2.2 Severity Levels:

Level	Test Voltage Contact Discharge (KV)	Test Voltage Air Discharge (KV)
1.	±2	±2
2.	±4	±4
3.	±6	±8
4.	±8	±15
X	Special	Special

9.3 Test Procedure

9.3.1 Air Discharge:

This test is done on a non-conductive surface. The round discharge tip of the discharge electrode shall be approached as fast as possible to touch the E.U.T. After each discharge, the discharge electrode shall be removed from the E.U.T.

The generator is then re-triggered for a new single discharge and repeated 10 times for each pre-selected test point. This procedure shall be repeated until all the air discharge completed.

9.3.2 Contact Discharge:

All the procedure shall be same as Section 9.3.1. except that the tip of the discharge electrode shall touch the E.U.T.

9.3.3 Indirect discharge for horizontal coupling plane

At least 10 single discharges(in the most sensitive polarity) shall be applied at the front edge of each HCP opposite the center point of each unit(if applicable) of the E.U.T. and 0.1m from the front of the E.U.T.. The long axis of the discharge electrode shall be in the plane of the HCP and perpendicular to its front edge during the discharge.

9.3.4 Indirect discharge for vertical coupling plane

At least 10 single discharge (in the most sensitive polarity) shall be applied to the center of one vertical edge of the coupling plane. The coupling plane, of dimensions 0.5m X 0.5m, is placed parallel to, and positioned at a distance of 0.1m from the E.U.T.. Discharges shall be applied to the coupling plane, with this plane in sufficient different positions that the four faces of the E.U.T. are completely illuminated.

9.4 Test Results

PASS.

Please refer to the following page.

Electrostatic Discharge Test Results

Ambient Condition:		Temp.: 25°C		R.H.: 50 %		Air Pressure: 101 kPa		
Power Supply:		AC 230V 50Hz						
Tested mode:		AUX IN, Optical IN, USB Playing						
Required Performance Criterion: B								
Direct Discharge								
-	Air discharge (KV)				Contact discharge (KV)			
Test Point	±2	±4	±6	±8	±2	±4	-	-
1	A	A	A	A	A	A	-	-
2	B	B	B	B	B	B	-	-
3	A	A	A	A	A	A	-	-
Indirect Discharge								
-	HCP (KV)				VCP (KV)			
Test Point	±2	±4	-	-	±2	±4	-	-
Front	A	A	-	-	A	A	-	-
Left	A	A	-	-	A	A	-	-
Right	A	A	-	-	A	A	-	-
Back	A	A	-	-	A	A	-	-
Test result					PASS			
<p>Note: The EUT stop working during the test, but it can be resumed to normal operation by user after test. After consider with client's confirmation that relevant instruction will be mentioned in the manual, so the test result was considered to be passed.</p>								
Test Engineer : Alvin								

Electrostatic discharge immunity test- Appendix I

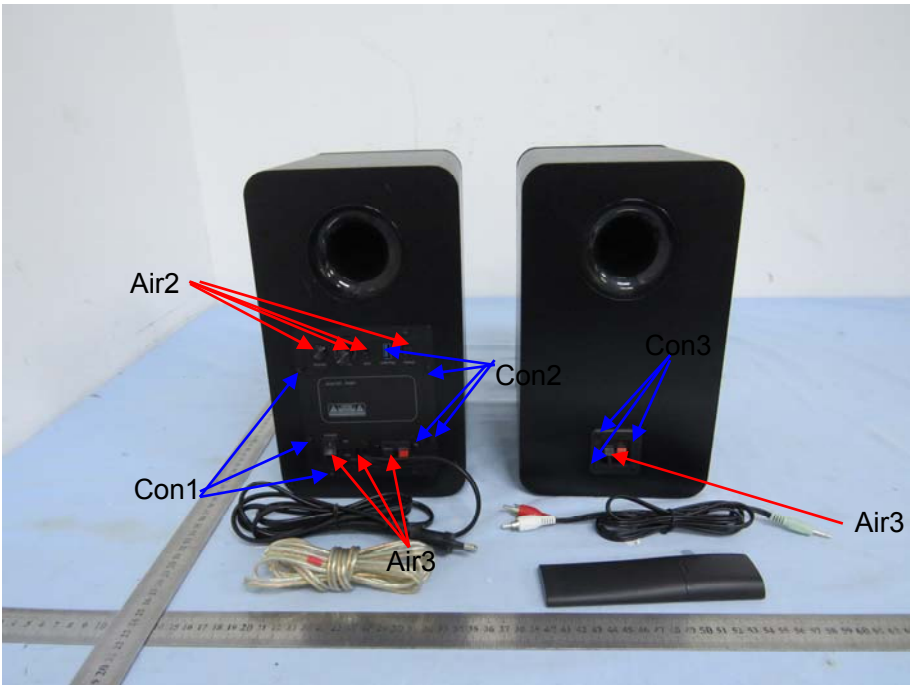

10. RF FIELD STRENGTH SUSCEPTIBILITY TEST

10.1 Block Diagram of Test Setup

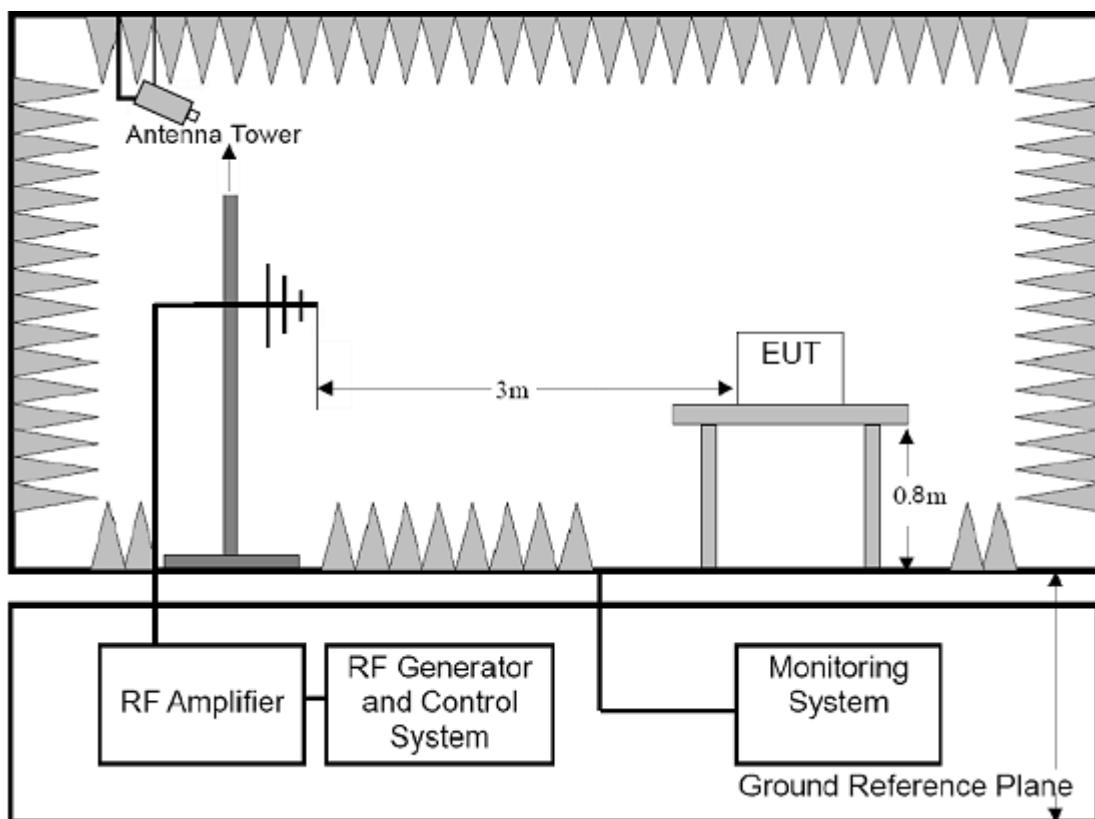

For Acoustic mode:

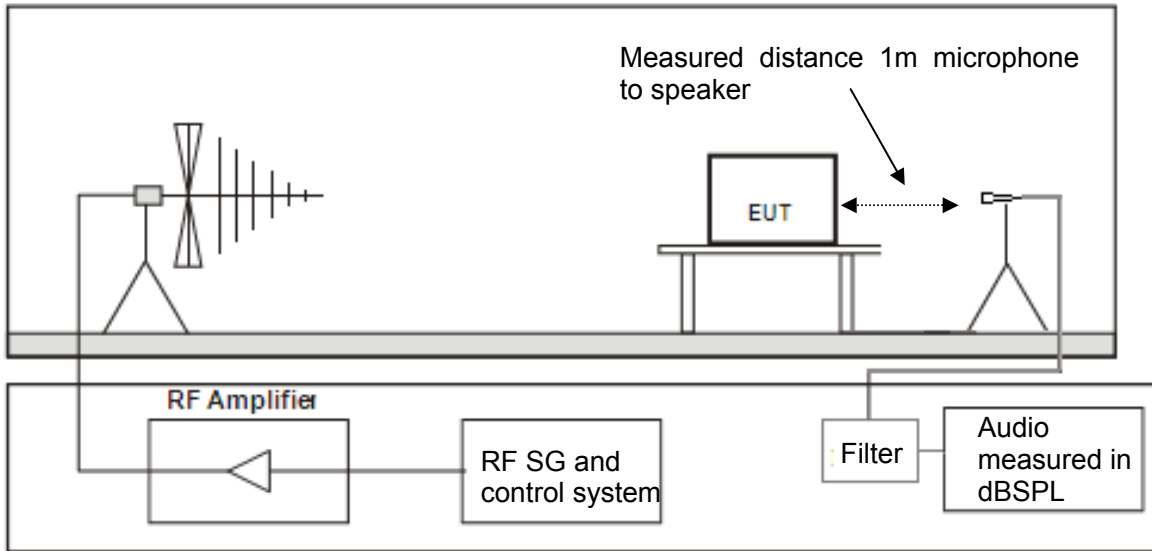

For Electrical mode:

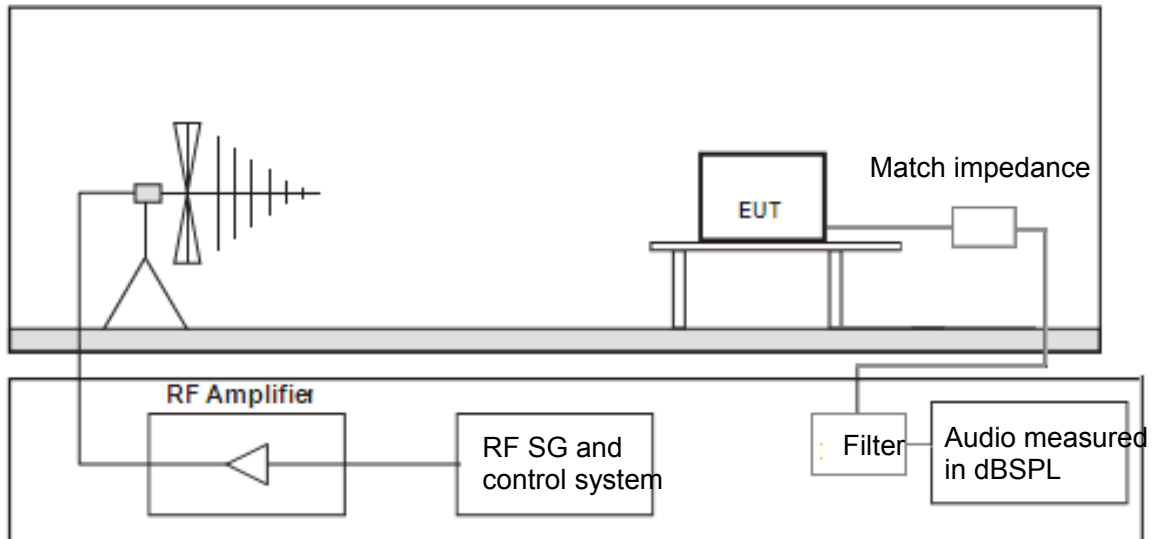

10.2 Test Standard and Severity Levels

10.2.1 Test Standard

EN 55035

(IEC 61000-4-3, Severity Level: 2, 3V / m)

10.2.2 Severity Levels

Level	Field Strength V/m
1.	1
2.	3
3.	10
X	Special

10.3 Test Procedure

The E.U.T. and its simulators are placed on a turn table which is 0.8 meter above ground. E.U.T. is set 3 meter away from the transmitting antenna which is mounted on an antenna tower. Both horizontal and vertical polarization of the antenna are set on test. Each of the four sides of E.U.T. must be faced this transmitting antenna and measured individually. All the scanning conditions are as follows:

Condition of Test	Remarks
1. Fielded Strength	3 V/m (Severity Level 2)
2. Radiated Signal	Modulated
3. Scanning Frequency	80-1000MHz, 1800MHz, 2600MHz, 3500MHz, 5000MHz
4. Dwell time of radiated	0.0015 decade/s
5. Waiting Time	1 Sec.

10.4 Test Results

PASS.

Please refer to the following page:

RF Field Strength Susceptibility Test Results

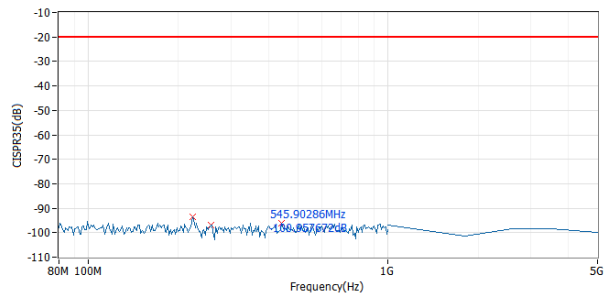
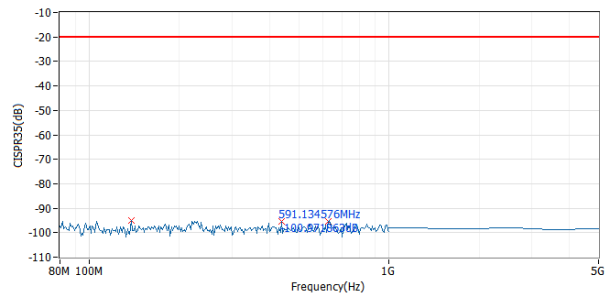
Ambient Condition:	Temp.: 25°C	R.H.: 50%	Air Pressure: 101 kPa	
Power Supply:	AC 230V 50Hz	Required Performance Criterion: A		
Test Specifications:	Modulation: 1kHz, 80%AM; Step Size: 1%; Dwell Time: 1s			
Tested mode:	AUX IN, USB Playing, Optical IN			
Frequency (MHz)	Level (V/m)	Antenna polarity	Side	Result (Performance Criterion)
80-1000 1800 2600 3500 5000	3	Horizontal/ Vertical	Front	A
			Left	A
			Right	A
			Back	A
			Worst case mode: USB Playing Note: The value of the reference level was 20dB as the limit.	
Horizontal		Vertical		
				
TEST RESULT		PASS		
Note: During the test, the EUT did not show any abnormality.				
				Test Engineer : Sean

11. ELECTRICAL FAST TRANSIENT/BURST IMMUNITY TEST

11.1 Block Diagram of Test Setup

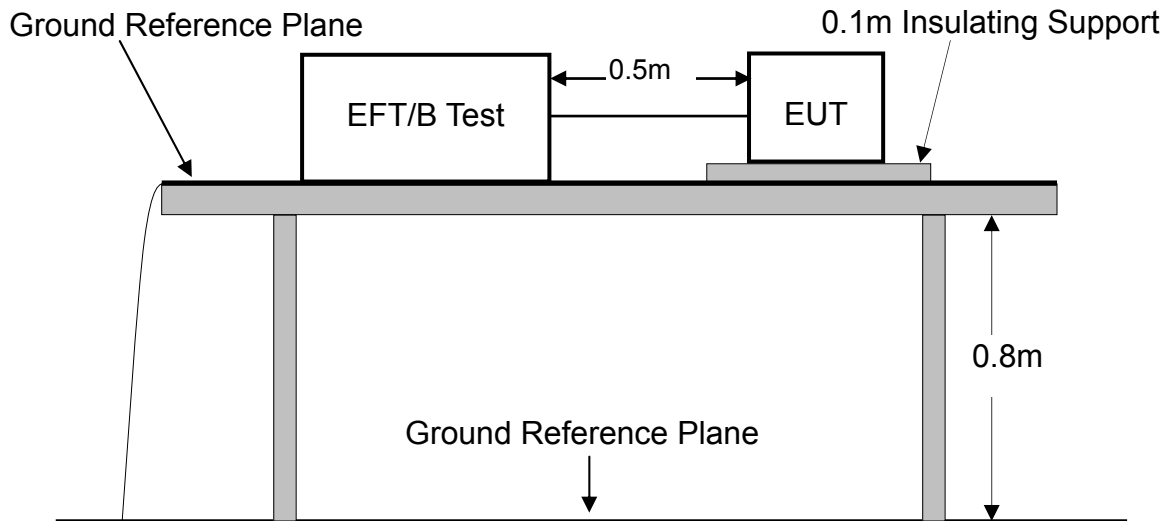

11.2 Test Standard and Severity Levels

11.2.1 Test Standard

EN 55035

(IEC 61000-4-4, Severity Level, Level 2: 1KV)

11.2.2 Severity level

Open circuit output test voltage and repetition rate of the impulses				
Level	On power port, PE		On I/O (Input/Output) Signal data and control ports	
	Voltage peak KV	Repetition rate KHz	Voltage peak KV	Repetition rate KHz
1.	0.5 KV	5 or 100	0.25 KV	5 or 100
2.	1 KV	5 or 100	0.5 KV	5 or 100
3.	2 KV	5 or 100	1 KV	5 or 100
4.	4 KV	5 or 100	2 KV	5 or 100
X	Special	Special	Special	Special

Note 1 Use of 5 KHz repetition rates is traditional; however, 100 KHz is closer to reality. Product committees should determine which frequencies are relevant for specific products or product types.

Note 2 With some products, there may be no clear distinction, between power ports and I/O ports, in which case it is up to product committees to make this determination for test purposes.

Note 3 "X" is an open level. The level has to be specified in the dedicated equipment specification.

11.3 Test Procedure

The E.U.T. is put on the table which is 0.8 meter high above the ground. This reference ground plane shall project beyond the E.U.T. by at least 0.1m on all sides and the minimum distance between E.U.T. and all other conductive structure, except the ground plane beneath the E.U.T., shall be more than 0.5m.

11.3.1 For input and output AC power ports:

The E.U.T. is connected to the power mains by using a coupling device which couples the EFT interference signal to AC power lines. Both polarities of the test voltage should be applied during compliance test and the duration of the test is 2 minutes.

11.3.2 For signal lines ports:

It's unnecessary to test.

11.3.3 For DC ports:

It's unnecessary to test.

11.4 Test Result

PASS.

Please refer to the following page.

Electrical Fast Transient/Burst Test Results

Ambient Condition:	Temp.: 25°C	R.H.: 50 %	Air Pressure: 101 kPa
Power Supply:	AC 230V 50Hz	Required Performance Criterion: B	
Test Level:	Repetition Frequency: 5kHz; Duration: 15ms; Period: 300ms		
Test mode:	AUX IN, USB Playing, Optical IN		
Line :	<input checked="" type="checkbox"/> AC Mains	<input type="checkbox"/> Signal line	<input type="checkbox"/> DC line
Coupling :	<input checked="" type="checkbox"/> Direct	<input type="checkbox"/> Capacitive	
Line	Test Voltage	Result (Performance Criterion)	
L	±1KV	A	
N	±1KV	A	
PE	-	-	
L、N	±1KV	A	
L、PE	-	-	
N、PE	-	-	
L、N、PE	-	-	
Signal port	-	-	
DC line	-	-	
<p>Note: During the test, the EUT did not show any abnormality.</p>			
<p>Test Equipment : Burst Tester(EM TEST, UCS500N)</p>		<p>Test Engineer : Alvin</p>	

12. SURGE IMMUNITY TEST

12.1 Block Diagram of Test Setup

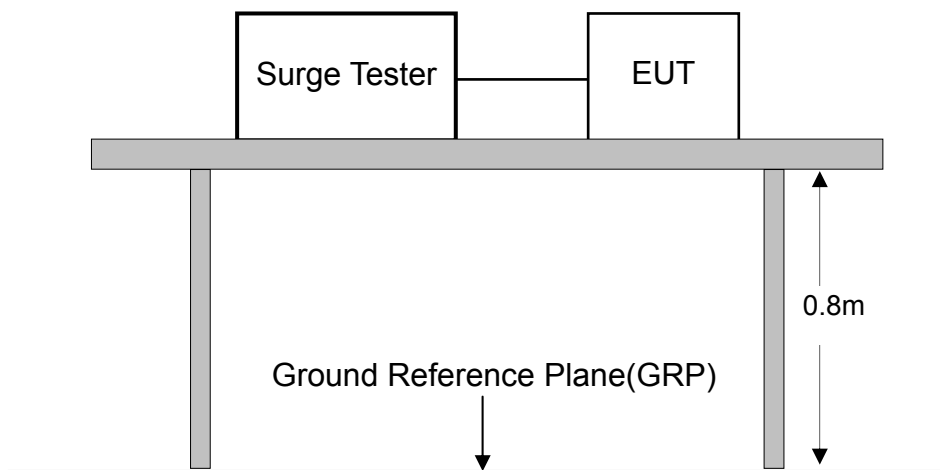

12.2 Test Standard and Severity Levels

12.2.1 Test Standard

EN 55035

(IEC 61000-4-5, Severity Level: Line To Line, Level 2: 1.0KV)

12.2.2 Severity level

Severity Level	Open-Circuit Test Voltage KV
1	0.5
2	1.0
3	2.0
4	4.0
*	Special

12.3 Test Procedure

1. Set up the E.U.T. and test generator as shown on Section 12.1.
2. For Mains line to line coupling mode, provide a 1.0KV 1.2/50us voltage surge (at open-circuit condition) and 8/20us current surge to E.U.T. selected points.
For signal line, provide a 1.0KV 10/700us voltage surge.
3. Five positive pulses Line-to-neutral at 90°phase, Five negative pulses Line-to-neutral at 270°phase. with a maximum 1/min repetition rate are conducted during test.
4. Different phase angles are done individually.
5. Record the E.U.T. operating situation during compliance test and decide the E.U.T. immunity criterion for above each test.

12.4 Test Result

PASS.

Please refer to the following page.

Surge Immunity Test Results

Ambient Condition:	Temp.: 25°C	R.H.: 50 %	Air Pressure: 101 kPa
Power Supply:	AC 230V 50Hz	Required Performance Criterion: B	
Test Specifications:	Voltage surge 1.2/50 us ; Current surge 8/20 us ; Five positive pulses Line-to-neutral at 90°phase, Five negative pulses Line-to-neutral at 270°phase.		
Test mode:	AUX IN, USB Playing, Optical IN		
Line	Phase Angle	Test Voltage	Result (Performance Criterion)
L-N	90°	+1KV	A
	270°	-1KV	A
L-PE	-	-	-
	-	-	-
N-PE	-	-	-
	-	-	-
Telecommunication Port	-	-	-
	-	-	-
DC line	-	-	-
	-	-	-
<p>Note: During the test, the EUT did not show any abnormality.</p>			
Test Equipment : Surge Tester(EM TEST, UCS500N)		Test Engineer : Loki	

13. INJECTED CURRENTS SUSCEPTIBILITY TEST

13.1 Block Diagram of Test Setup

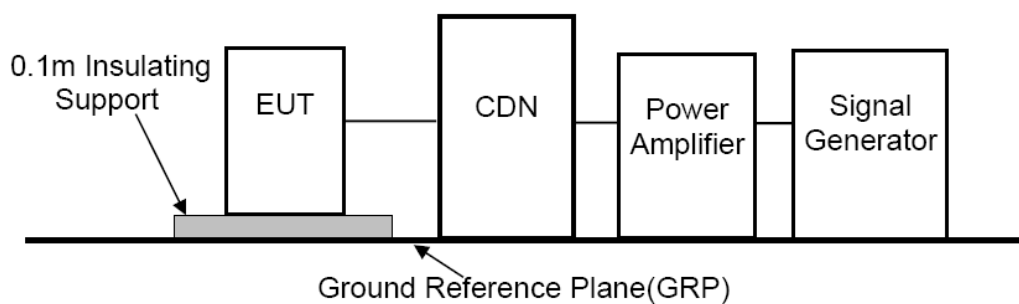

For Electrical measurements setup:

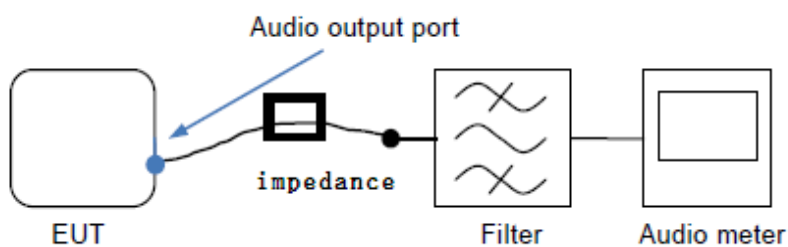

For Acoustic measurements setup:

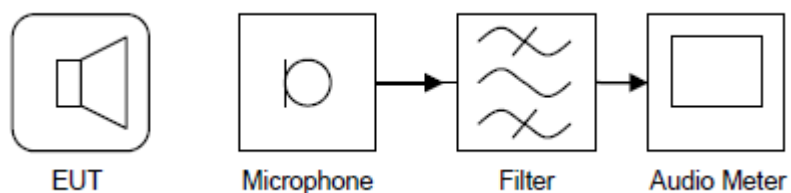

13.2 Test Standard and Severity Levels

13.2.1 Test Standard

EN 55035
(IEC 61000-4-6:2013)

13.2.2 Severity level

Level	Field Strength V
0.15-10MHz	3
10-30MHz	3 to 1 *
30-80MHz	1

Note*: Where the amplitude of a test level varies over a given frequency range, it changes linearly with respect to the logarithm of the frequency.

13.3 Test Procedure

1. Set up the E.U.T., CDN and test generators as shown on Section 13.1.
2. Let the E.U.T. work in test mode and measure it.
3. The E.U.T. are placed on an insulating support 0.1m high above a ground reference plane. CDN (coupling and decoupling device) is placed on the ground plane about 0.3m from E.U.T.. Cables between CDN and E.U.T. are as short as possible, and their height above the ground reference plane shall be between 30 and 50 mm (where possible).
4. The disturbance signal described below is injected to E.U.T. through CDN.
5. The E.U.T. operates within its operational mode(s) under intended climatic conditions after power on.
6. The frequency range is swept from 150 KHz to 10 MHz using 3V signal level, from 10 MHz to 30 MHz using 3V to 1V changes linearly, from 30 MHz to 80 MHz using 1V signal level, and with the disturbance signal 80% amplitude modulated with a 1KHz sine wave.
7. The rate of sweep shall not exceed 1.5×10^{-3} decades/s. Where the frequency is swept incrementally, the step size shall not exceed 1% of the start and thereafter 1% of the preceding frequency value.
8. Recording the E.U.T. operating situation during compliance testing and decide the E.U.T. immunity criterion.

13.4 Test Result

PASS.

Please refer to the following page.

Injected Currents Susceptibility Test Results

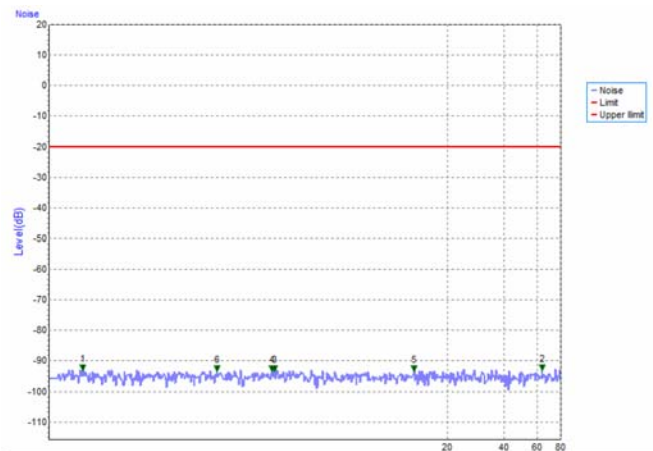
Ambient Condition:	Temp.: 25 °C	R.H.: 50%	Air Pressure: 101 kPa
Power Supply:	AC 230V 50Hz	Required Performance Criterion: A	
Test Specifications:	Modulation : 1KHz, 80%AM, Step Size : 1%, Dwell Time : 3s		
Test mode:	AUX IN, USB Playing, Optical IN		
Test Port	Frequency (MHz)	Level(V)	Result (Performance Criterion)
AC Mains	0.15~10	3	A
	10~30	3 to 1	A
	30~80	1	A
<p>Worst case mode: USB Playing</p> <p>Note: The value of the reference level was 20dB as the limit.</p>			
			
Test Result		Pass	
Note: During the test, the EUT did not show any abnormality.			
Test Engineer : Sean			

14. VOLTAGE DIPS AND INTERRUPTIONS TEST

14.1 Block Diagram of Test Setup

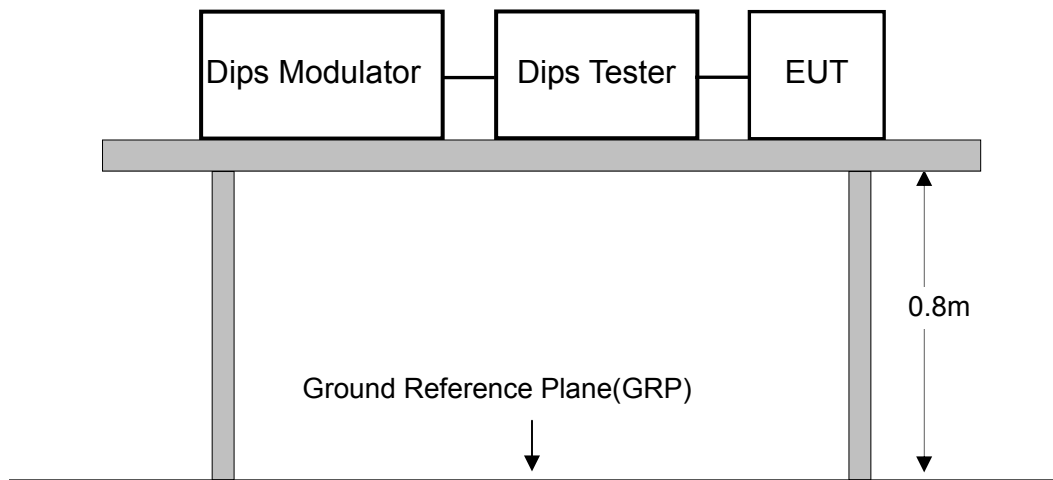

14.2 Test Standard and Severity Levels

14.2.1 Test Standard

EN 55035
 (IEC 61000-4-11)

14.2.2 Severity level

Test Level %UT	Voltage dip and short interruptions %UT	Duration (in period)
0	100	0.5 1
40	60	5 10
70	30	25 50 *

14.3 Test Procedure

1. Set up the E.U.T. and test generator as shown on Section 14.1.
2. The interruptions are introduced at selected phase angles with specified duration.
3. Record any degradation of performance.

14.4 Test Result

PASS.

Please refer to the following page.

Voltage Dips And Interruptions Test Results

Ambient Condition:	Temp.: 25 °C	R.H.: 50%	Air Pressure: 101 kPa
Power Supply:	AC 230V 50/60Hz	Required Performance Criterion: B & C	
Test Specifications:	0%UT, 0.5Cycle; 30%UT, 25Cycle; 0%UT,250Cycle		
Test mode:	AUX IN, USB Playing, Optical IN		
Test Level % UT	Duration (in period)		Result (Performance Criterion)
	50Hz	60Hz	
0	0.5P	0.5P	A
70	25P	30P	A
0	250P	300P	C
Note : During the test, the EUT power off, but it can be recovered by user after test.			
Test Result		Pass	
Test Equipment : Dips Tester: EM TEST, UCS 500N		Test Engineer : Loki	

15. PHOTOGRAPHS

15.1 Photo of Radiated Emission Measurement

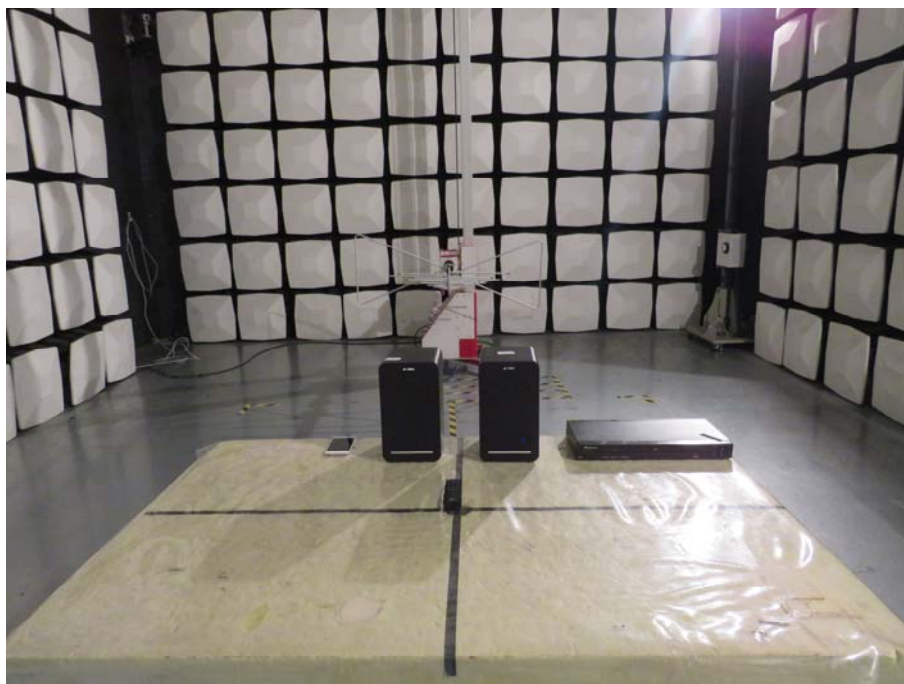

15.2 Photo of Power Line Conducted Emission Measurement



15.3 Photo of Harmonic Current / Flicker Measurement



15.4 Photo of Electrostatic Discharge Immunity Measurement



15.5 Photo of RF Electromagnetic Field Immunity



15.6 Photo of Electrical Fast Transient /Burst /Surge /Voltage Dips



15.7 Photo of Injected Currents Immunity



APPENDIX I (PHOTOS OF E.U.T.)

General Appearance of the E.U.T.









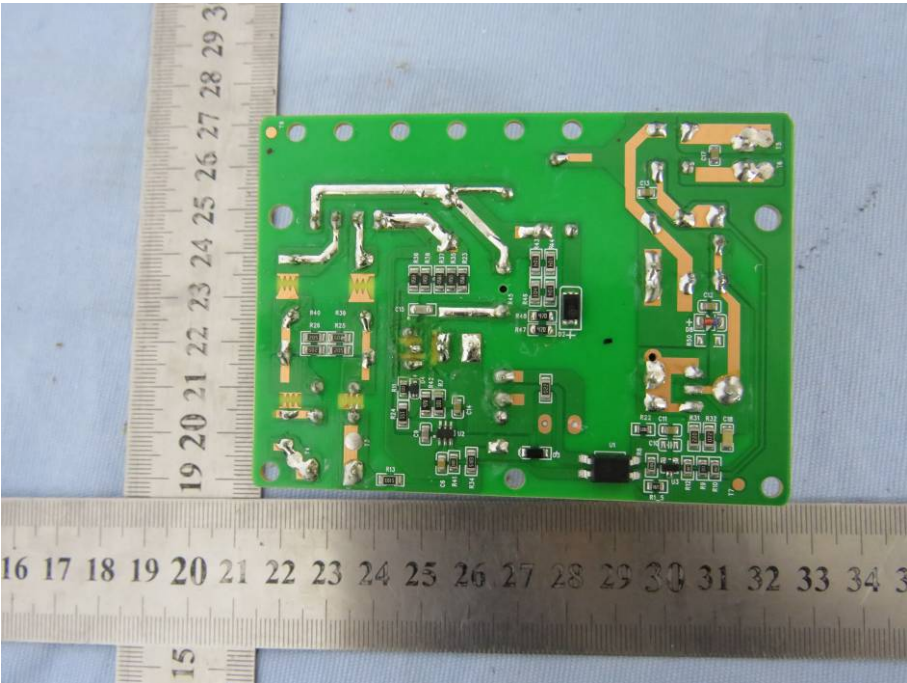
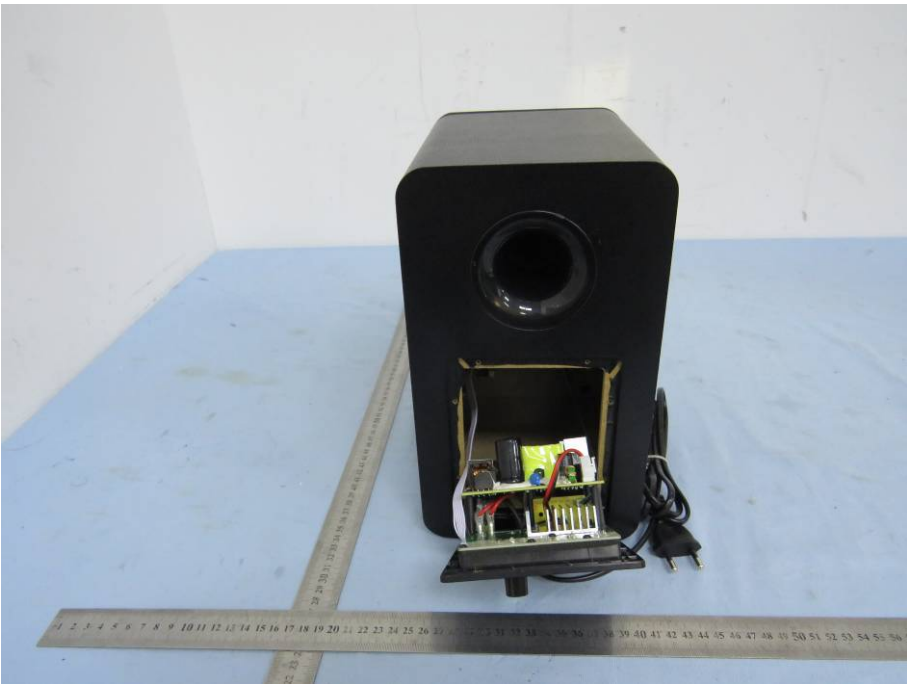

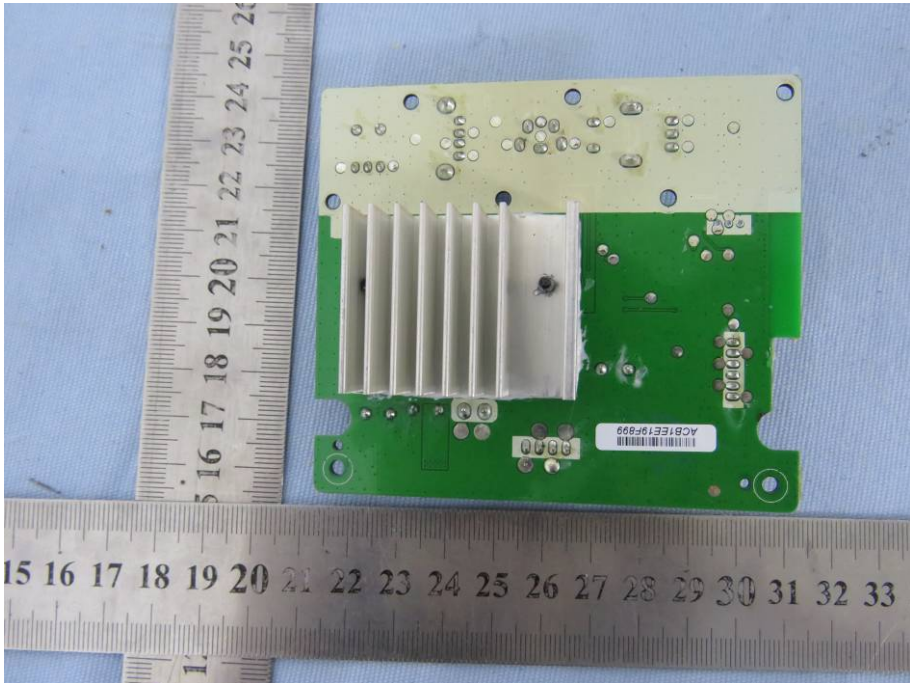
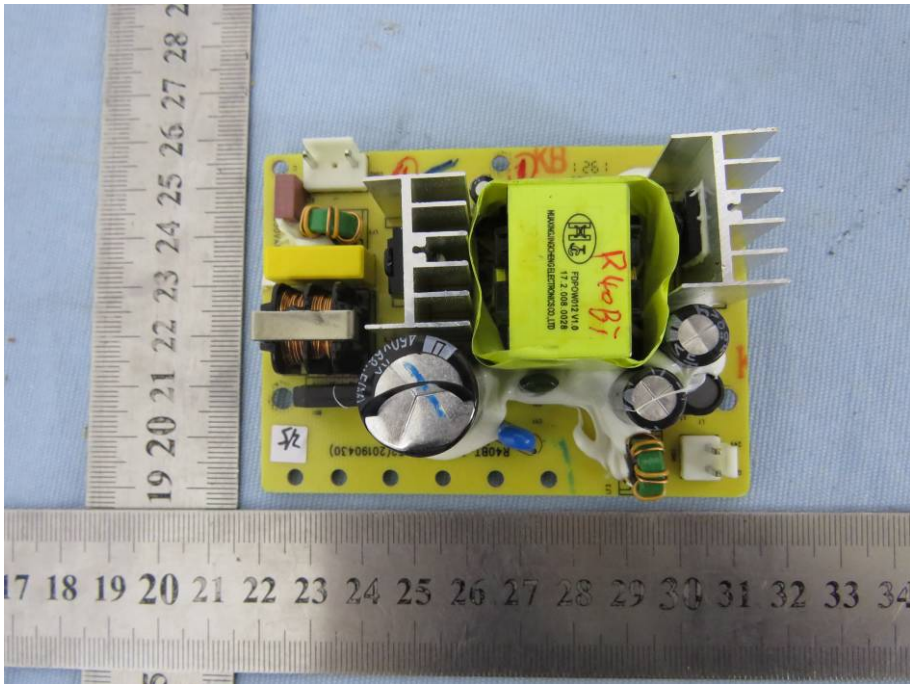

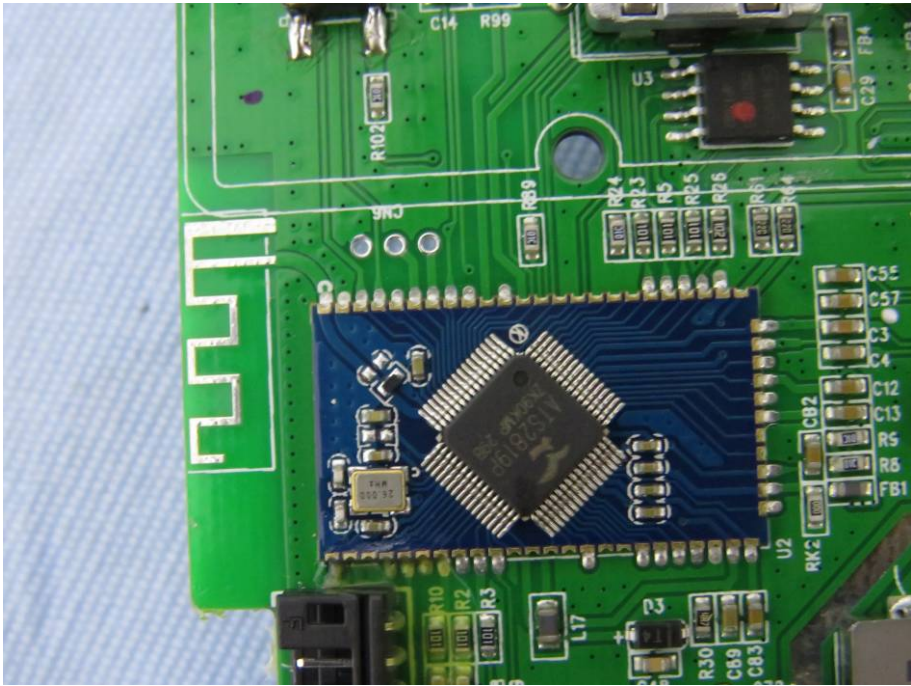
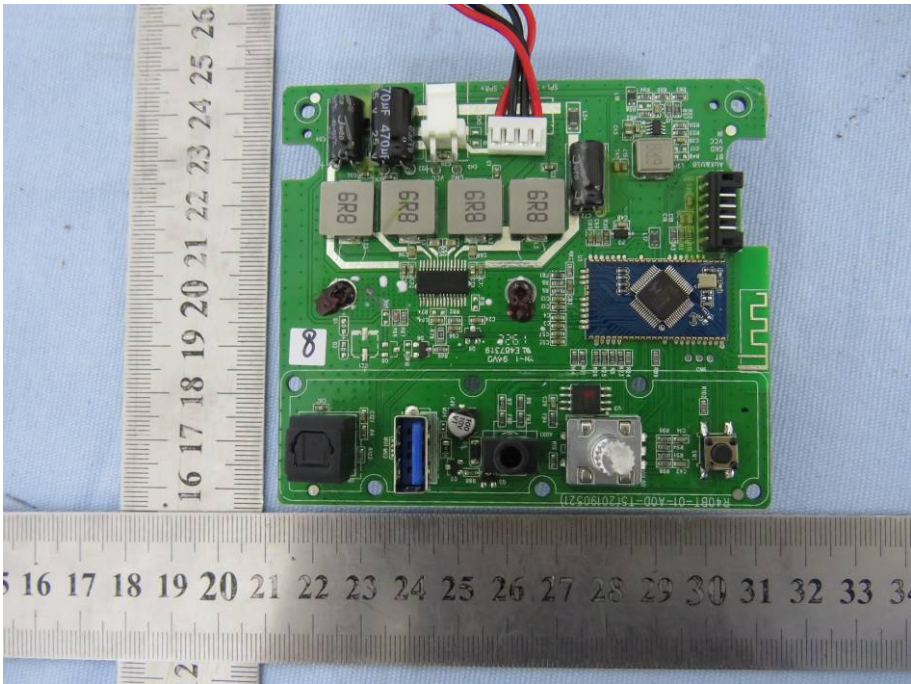

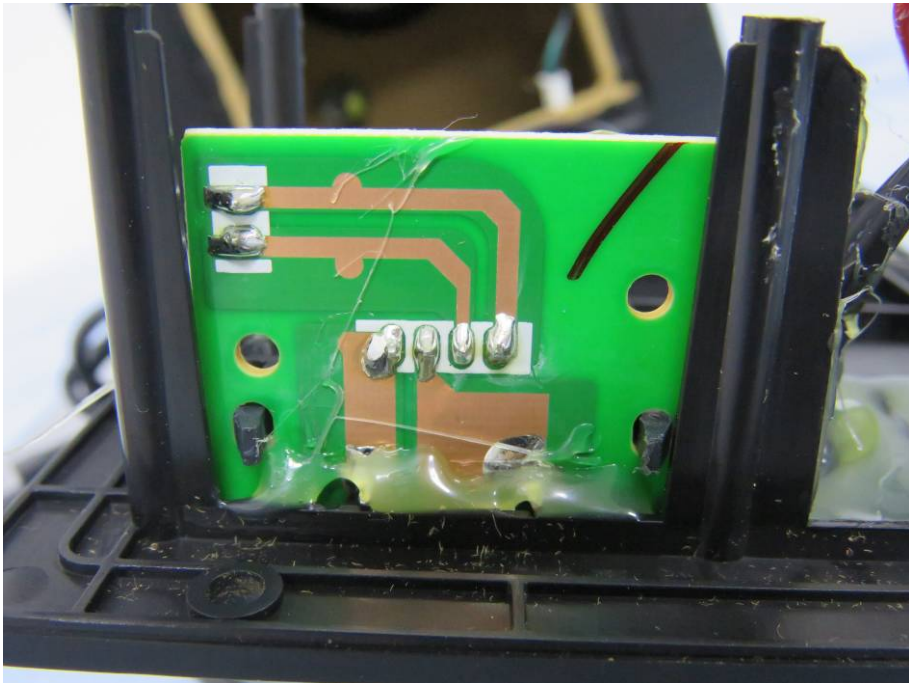
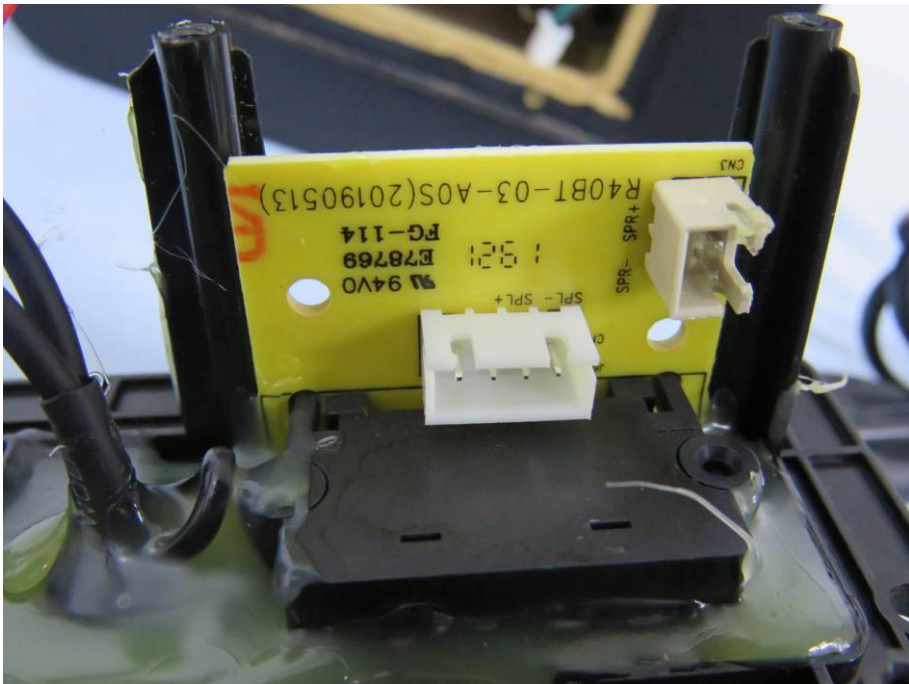

---End---