

RF TEST REPORT

The device described below is tested by Dongguan Nore Testing Center Co., Ltd. to determine the maximum emission levels emanating from the device, the severe levels which the device can endure and E.U.T.'s performance criterion. The test results, data evaluation, test procedures, and equipment of configurations shown in this report were made in accordance with the RED directive 2014/53/EU.

Applicant : SHENZHEN FENDA TECHNOLOGY CO., LTD.
Address : Fenda Hi-Tech Park, Zhoushi Road, Shiyao Town, Baoan District, Shenzhen City, Guangdong, China
Manufacturer/Factory : SHENZHEN FENDA TECHNOLOGY CO., LTD.
Address : Fenda Hi-Tech Park, Zhoushi Road, Shiyao Town, Baoan District, Shenzhen City, Guangdong, China
E.U.T. : Computer Multimedia Speaker
Brand Name : F&D
Model No. : T-70X, T-77X, T-70BT, T-80X, T-68X, T-60X Plus
(For model difference refer to section 1)
Measurement Standard : ETSI EN 300328 V2.1.1: 2016
Date of Receiver : May 08, 2019; November 20, 2019
Date of Test : May 09, 2019 to July 07, 2019
Date of Report : December 05, 2019

This Test Report is Issued Under the Authority of :

Prepared by



Alina Guo / Engineer

Approved & Authorized Signer



Iori Fan / Authorized Signatory

This test report is for the customer shown above and their specific product only. This report applies to above tested sample only and shall not be reproduced in part without written approval of Dongguan Nore Testing Center Co., Ltd.

TABLE OF CONTENTS

- 1. GENERAL INFORMATION.....4**
 - PRODUCT DESCRIPTION FOR EQUIPMENT UNDER TEST 4
- 2. DESCRIPTION OF TEST MODES AND TEST FREQUENCIES.....7**
- 3. TEST FREQUENCIES AND SOFTWARE.....7**
- 4. OBJECTIVE.....7**
- 5. TEST METHODOLOGY.....7**
- 6. TEST FACILITY8**
- 7. MEASUREMENT UNCERTAINTY8**
- 8. SUPPORT EQUIPMENT9**
- 9. RF OUTPUT POWER10**
- 10. DWELL TIME, MINIMUM FREQUENCY OCCUPATION AND.....12**
HOPPING SEQUENCE.....12
- 11. OCCUPIED CHANNEL BANDWIDTH22**
- 12. HOPPING FREQUENCY SEPARATION26**
- 13. TRANSMITTER UNWANTED EMISSIONS IN THE OUT-OF BAND DOMAIN30**
- 14. TRANSMITTER SPURIOUS EMISSIONS.....33**
- 15. RECEIVER SPURIOUS EMISSIONS.....37**
- 16. RECEIVER BLOCKING40**
- 17. TEST EQUIPMENT LIST43**
- APPENDIX I.....44**
INFORMATION AS REQUIRED BY EN 300 328 V2.1.1, CLAUSE 5.4.144
- APPENDIX II.....50**
- PHOTOGRPHS OF TEST SETUP50**

Revision History of This Test Report

Report Number	Description	Issued Date
NTC1905055EV00	Initial Issue	2019-07-10
NTC1905055EV01	Updated the electrolytic capacitor voltage from 35V change 50V at PCB output circuit.	2019-12-05

1. GENERAL INFORMATION

PRODUCT DESCRIPTION FOR EQUIPMENT UNDER TEST

E.U.T.	:	Computer Multimedia Speaker
Main Model Name	:	T-70X
Additional Model name	:	T-77X, T-70BT, T-80X, T-68X, T-60X Plus
Brand Name	:	F&D
Rating	:	AC 100-240V 50/60Hz, 1A
Adapter	:	N/A
Test Voltage	:	AC 230V 50Hz
Cable	:	Audio Line: 1 to 1: 1.54m unshielded 1 to 2: 1.54m unshielded Speaker Line: 2.94m unshielded AC Mains: 1.50m unshielded
Hardware version	:	V1.0
Software version	:	V1.0
Operating Temperature Range	:	0°C to 35°C (Declaration by manufacturer)
Description of model difference	:	Those models have the same circuit schematic, construction, PCB Layout and critical components. The difference is model number only due to trading purpose.
Note	:	According to the model difference, all tests were performed on model T-70X.
Remark	:	<ol style="list-style-type: none">1. This report was an additional report based on report NTC1905055EV00.2. Compared with original report, this report has updated the electrolytic capacitor voltage from 35V change 50V at PCB output circuit.3. According to the changes, no affect the tests result and all items test data were continued to be referenced. Details refer to the report.

Technical Specification:

Item	:	Description
BT Version	:	4.2
Frequency	:	2402-2480MHz
Modulation	:	GFSK, $\pi/4$ -DQPSK, 8DPSK
Number of Channel	:	79
Channel space	:	1MHz
Antenna Type	:	PCB antenna
Antenna Gain	:	0.5dBi (declared by manufacturer)

SUMMARY OF TEST RESULTS		
Section (ETSI EN 300328)	Description of Test	TEST RESULT
4.3.1.2/4.3.2.2	RF Output Power	Compliant
4.3.2.3	Power Spectral Density (Modulations other than FHSS equipment)	N/A
4.3.1.3 / 4.3.2.4	Duty cycle, Tx-Sequence, Tx-gap (Non-adaptive equipment)	N/A ^{see note 1}
4.3.1.4	Dwell time, Minimum Frequency Occupation & Hopping Sequence (FHSS equipment)	Compliant
4.3.1.5	Hopping Frequency Separation (FHSS equipment)	Compliant
4.3.1.6 / 4.3.2.5	Medium Utilisation (Non-adaptive equipment)	N/A ^{see note 2}
4.3.1.7 / 4.3.2.6	Adaptivity	N/A ^{see note 2}
4.3.1.8 / 4.3.2.7	Occupied Channel Bandwidth	Compliant
4.3.1.9 / 4.3.2.8	Transmitter unwanted emission in the OOB domain	Compliant
4.3.1.10 / 4.3.2.9	Transmitter unwanted emissions in the spurious domain	Compliant
4.3.1.11 / 4.3.2.10	Receiver spurious emissions	Compliant
4.3.1.12/4.3.2.11	Receiver Blocking	Compliant
4.3.1.13/4.3.2.12	Geo-location capability	N/A ^{see note 3}

Note 1: Only for equipment with Non-adaptive.

Note 2: These requirements do not apply for equipment with a maximum declared RF Output power of less than 10dBm EIRP or for equipment when operating in a mode where the RF Output power is less than 10dBm EIRP.

Note 3: Only for equipment with geo-location capability

2. DESCRIPTION OF TEST MODES AND TEST FREQUENCIES

The EUT has been tested under Normal Operating condition. Pre-defined engineering program for regulatory testing used to control the EUT for staying in continuous transmitting and receiving mode is programmed. All data rate and modulation type were tested, only the worst-case record in this report.

3. TEST FREQUENCIES AND SOFTWARE

Channel	Frequency MHz
0	2402
39	2441
78	2480

Test Item	Software	Description
Conducted RF Testing and Radiated testing	BT FCC Tool V1.02	Set the EUT to different modulation and channel

4. OBJECTIVE

Electromagnetic compatibility and Radio spectrum Matters (ERM); Wideband Transmission systems; Data transmission equipment operating in the 2.4GHz ISM band and using wide band modulation techniques; Harmonized EN covering essential requirements under article 3.2 of the RE-D directive.

The objective is to determine compliance with ETSI EN 300328 V2.1.1 (2016-11).

5. TEST METHODOLOGY

All measurements contained in this report were conducted with ETSI EN 300328 V2.1.1 (2016-11).

6. TEST FACILITY

Site Description

- EMC Lab : Listed by CNAS, August 13, 2018
 The certificate is valid until August 13, 2024
 The Laboratory has been assessed and proved to be in compliance with CNAS/CL01
 The Certificate Registration Number is L5795.
- Listed by A2LA, November 01, 2017
 The certificate is valid until December 31, 2021
 The Laboratory has been assessed and proved to be in compliance with ISO17025
 The Certificate Registration Number is 4429.01
- Listed by FCC, November 06, 2017
 The Designation Number is CN1214
 Test Firm Registration Number: 907417
- Listed by Industry Canada, June 08, 2017
 The Certificate Registration Number. Is 46405-9743
- Name of Firm : Dongguan Nore Testing Center Co., Ltd.
 (Dongguan NTC Co., Ltd.)
- Site Location : Building D, Gaosheng Science and Technology Park, Hongtu Road, Nancheng District, Dongguan City, Guangdong Province, China

7. MEASUREMENT UNCERTAINTY

Parameter	Uncertainty
Occupied Channel Bandwidth	$\pm 1.42 \times 10^{-4}\%$
RF output power, conducted	$\pm 1.06\text{dB}$
Power Spectral Density, conducted	$\pm 1.06\text{dB}$
Unwanted Emissions, conducted	$\pm 2.51\text{dB}$
All emissions, radiated	$\pm 3.70\text{dB}$
Temperature	$\pm 0.8^\circ\text{C}$
Humidity	$\pm 3.2\%$
DC and low frequency voltages	$\pm 0.1\%$
Time	$\pm 5\%$
Duty cycle	$\pm 5\%$

This uncertainty represents an expanded uncertainty expressed at approximately the 95% confidence level using a coverage factor of k=2

8. SUPPORT EQUIPMENT

Notebook PC	: Manufacturer: IBM Corporation M/N: R50e S/N: L3-HZNGO P/N: 1834KDC
Adapter	: Manufacturer: IBM Corporation M/N: 08K8210 Input: AC100-240V 50/60Hz 0.5-1.0A Output: DC 16V 4.5A

9. RF OUTPUT POWER

Limits

Frequency Band	Limit
2400 ~ 2483.5 MHz	Equivalent isotropic radiated power (e.i.r.p.) ≤20 dBm

Test Method

1. Please refer to ETSI EN 300328 (V_{2.1.1}) clause 5.4.2.2.1 for conducted measurement method.
2. The measurements shall be performed at both normal environmental conditions and at the extremes of the operating temperature range.

Test Configuration

Temperature and Voltage Measurement

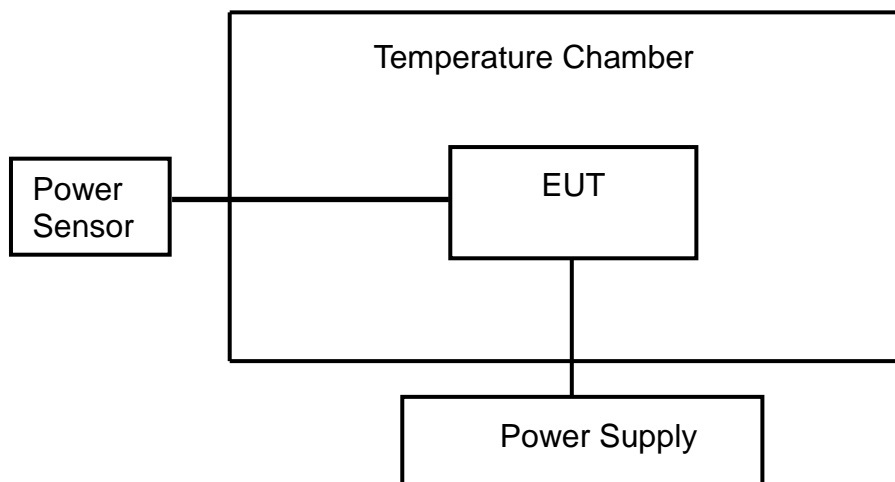

Test Result

Pass.

Please refer to following data tables.

GFSK					
Humidity :		52 %	Temperature :		22 °C
Test Result:		PASS	Test By:		Lee
Antenna Assembly Gain:				0.5dBi	
Cable Loss=				1.5dB	
Number of Burst				>20	
Hopping Mode					
Temperature (°C)	Power Supplied	Reading dBm	EIRP dBm	Limit dBm	
25	AC 230V	1.42	3.42	20	
0	AC 230V	0.43	2.43	20	
35	AC 230V	1.52	3.52	20	

Note: Calculated Power(dBm)=Output Power(dBm)+Cable Loss(dB)+Antenna Gain(dBi)

8DPSK					
Humidity :		52 %	Temperature :		22 °C
Test Result:		PASS	Test By:		Lee
Antenna Assembly Gain:				0.5dBi	
Cable Loss=				1.5dB	
Number of Burst				>20	
Hopping Mode					
Temperature (°C)	Power Supplied	Reading dBm	EIRP dBm	Limit dBm	
25	AC 230V	2.01	4.01	20	
0	AC 230V	1.64	3.64	20	
35	AC 230V	1.51	3.51	20	

Note: Calculated Power(dBm)=Output Power(dBm)+Cable Loss(dB)+Antenna Gain(dBi)

10. DWELL TIME, MINIMUM FREQUENCY OCCUPATION AND HOPPING SEQUENCE

Limits

Dwell Time	
Test Condition	Limit
Non-adaptive frequency hopping systems	≤ 15 ms
Adaptive frequency hopping systems	≤ 400 ms

Minimum Frequency Occupation Time	
Test Condition	Limit
Non-adaptive frequency hopping systems	Equal to one dwell time within a period not exceeding four times the product of the dwell time per hop and the number of hopping frequencies in use.
Adaptive frequency hopping systems	

Hopping sequence(s)	
Test Condition	Limit
Non-adaptive frequency hopping systems	≥15 hopping frequencies or 15/minimum Hopping Frequency Separation in MHz , whichever is the greater.
Adaptive frequency hopping systems	Operating frequency band ≥58.45MHz (Operating over a minimum of 70 % of the operating in the band 2,4 GHz to 2,4835 GHz)
	≥15 hopping frequencies or 15/minimum Hopping Frequency Separation in MHz , whichever is the greater.

Test Method

1. Please refer to ETSI EN 300328 (V_{2.1.1}) clause 5.4.4.2.1 for conducted measurement method.
2. The measurements shall be performed at normal environmental condition.

Test Configuration



Test Result

Pass.

Please refer to following data tables and test plots.

Temperature :	25 °C	Humidity :	53%
Test Date :	June 19, 2019	Test Result:	PASS
Test By:	Lee		

Hopping Sequence				
Hopping Channels	Hopping Channels Limits	Min. Hopping Range (%)	Min. Hopping Range Limit(%)	Result
GFSK				
79	15	95.46	70.00%	PASS
8DPSK				
79	15	96.40	70.00%	PASS

Dwell Time					
Mode	Number of Hopping Channel	Number of transmission in a period (channel number *0.4sec	Dwell Time	Limit (ms)	Result
		Period (Sec)			
GFSK					
DH1	79	31.6	131.20	400	PASS
DH3	79	31.6	265.60	400	PASS
DH5	79	31.6	311.37	400	PASS
8DPSK					
3-DH1	79	31.6	128.00	400	PASS
3-DH3	79	31.6	267.20	400	PASS
3-DH5	79	31.6	309.52	400	PASS

Minimum Frequency Occupation				
Mode	Number of Hopping Channel	Number of times (hopping frequency of hopping sequence)	Minimum Limit	Result (Pass/Fail)
GFSK				
DH1	79	1	≥1	PASS
DH3	79	3	≥1	PASS
DH5	79	3	≥1	PASS
8DPSK				
3-DH1	79	1	≥1	PASS
3-DH3	79	3	≥1	PASS
3-DH5	79	3	≥1	PASS

GFSK DH1

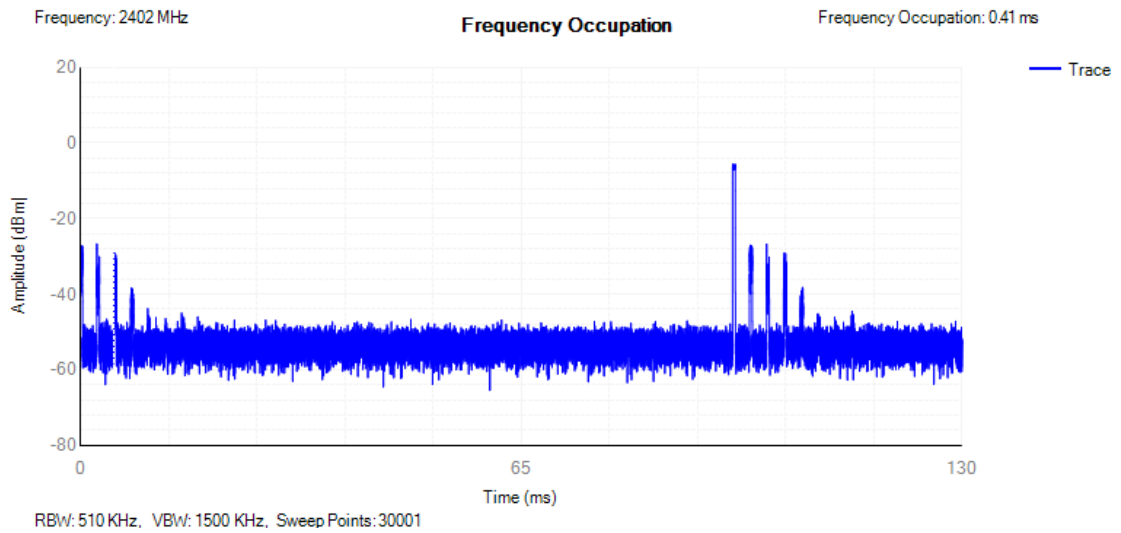
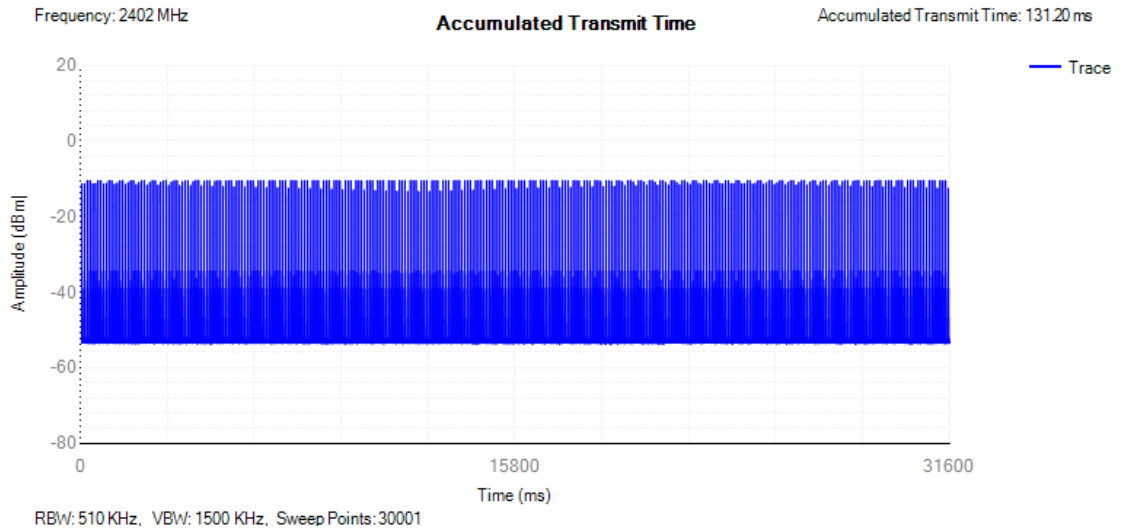

GFSK DH3

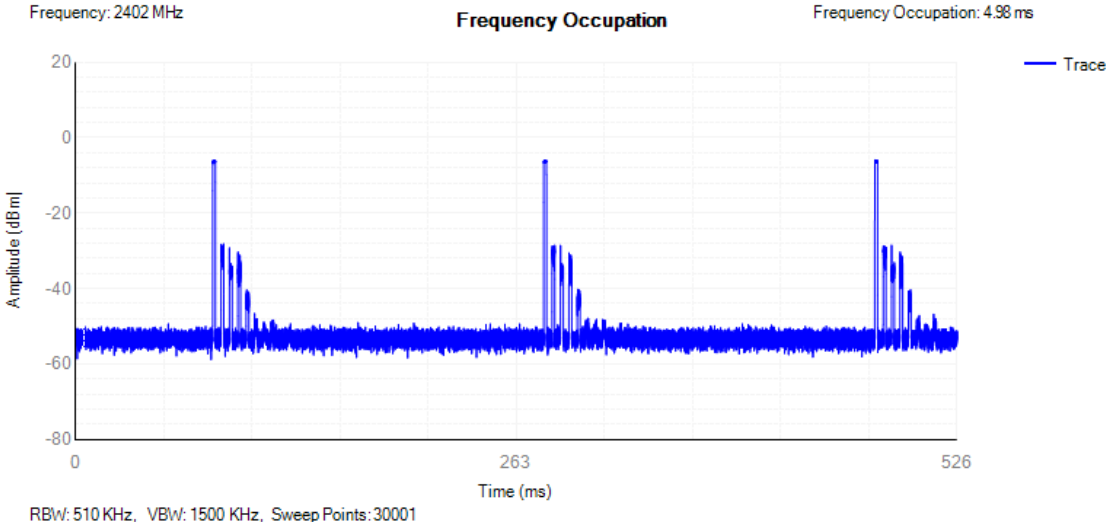
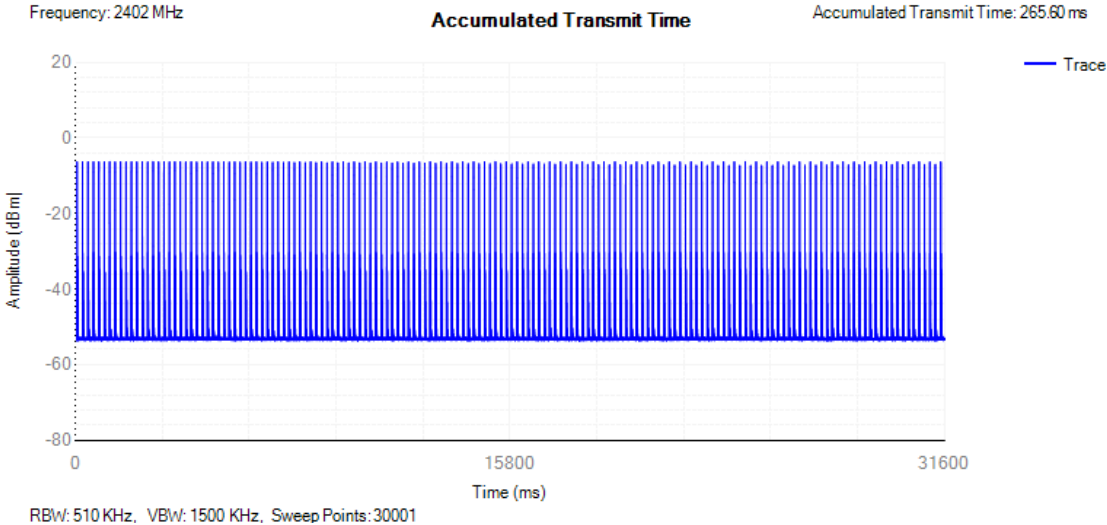

GFSK DH5

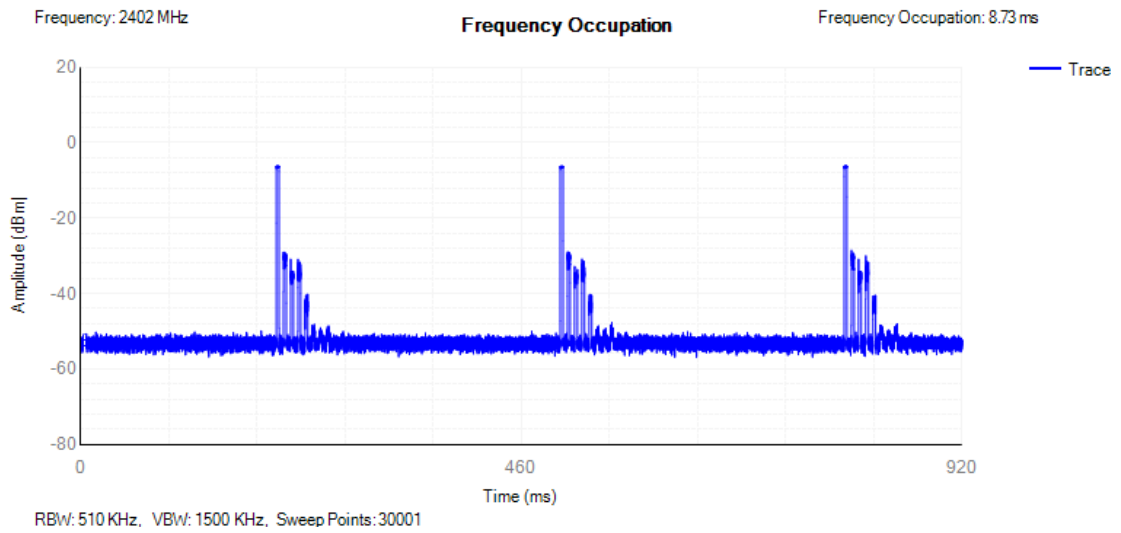
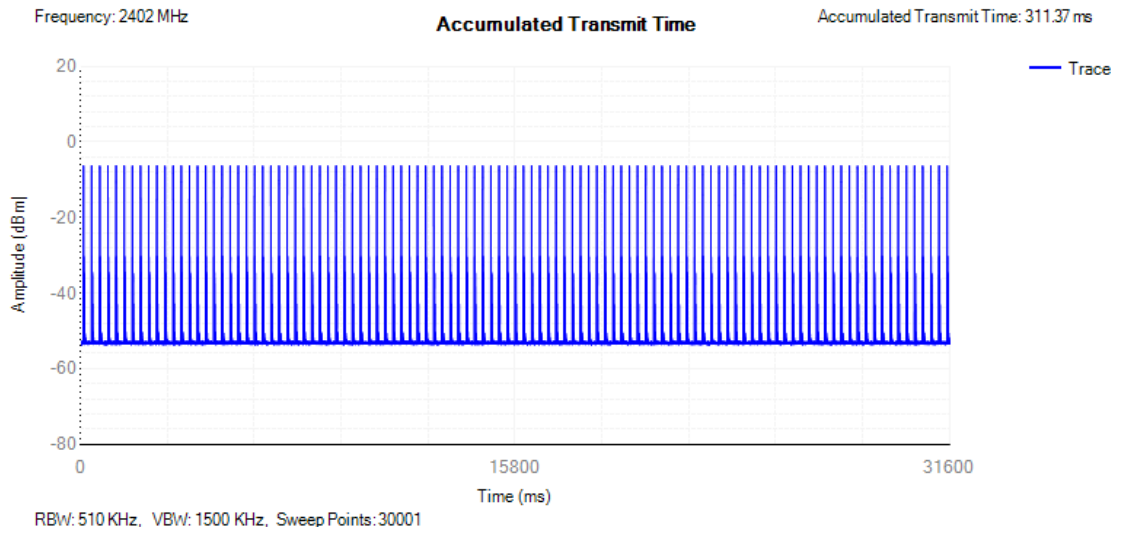

8DPSK 3-DH1

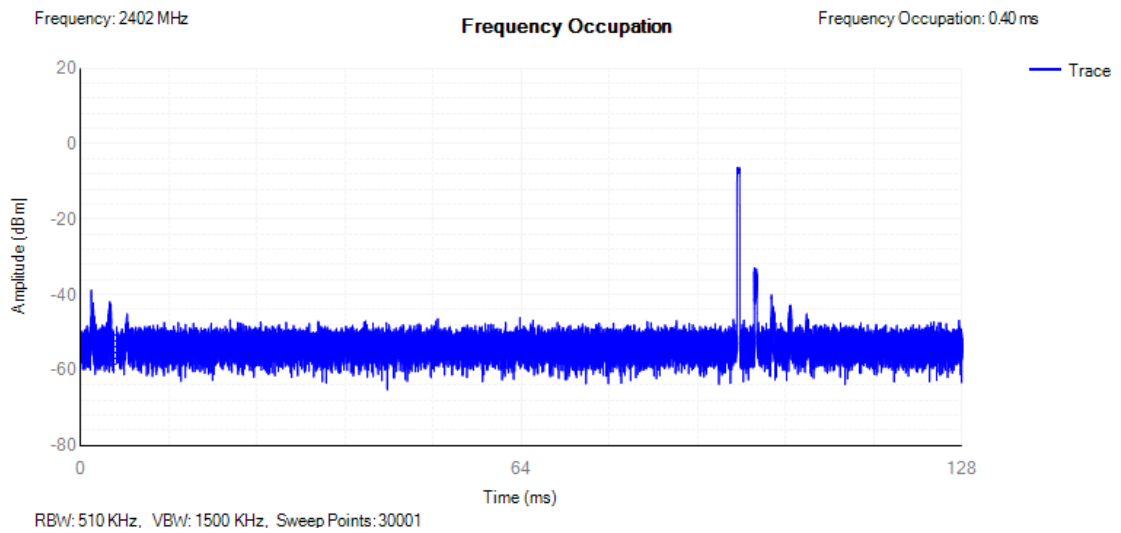
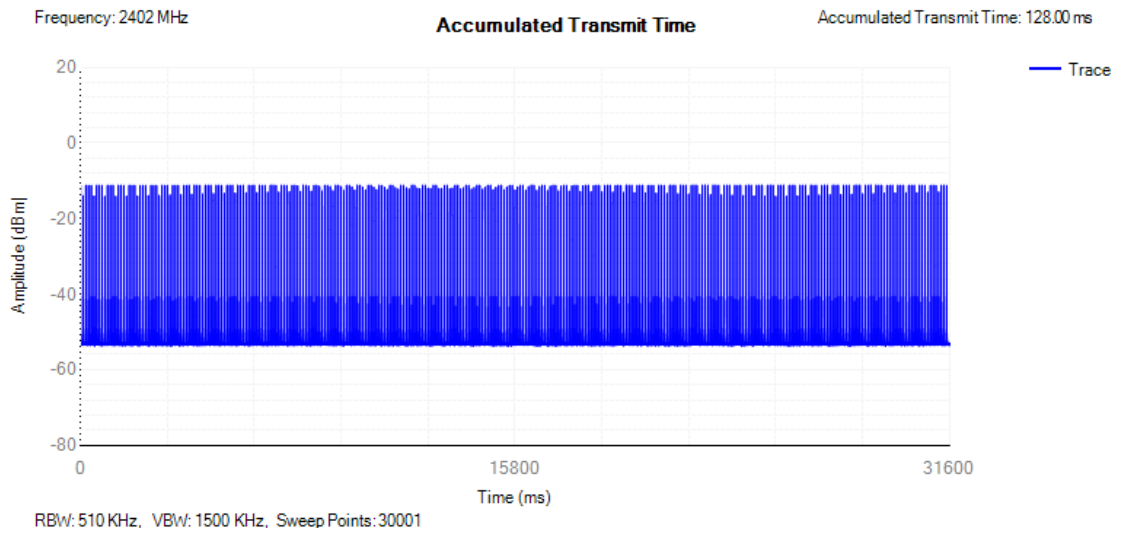

8DPSK 3-DH3

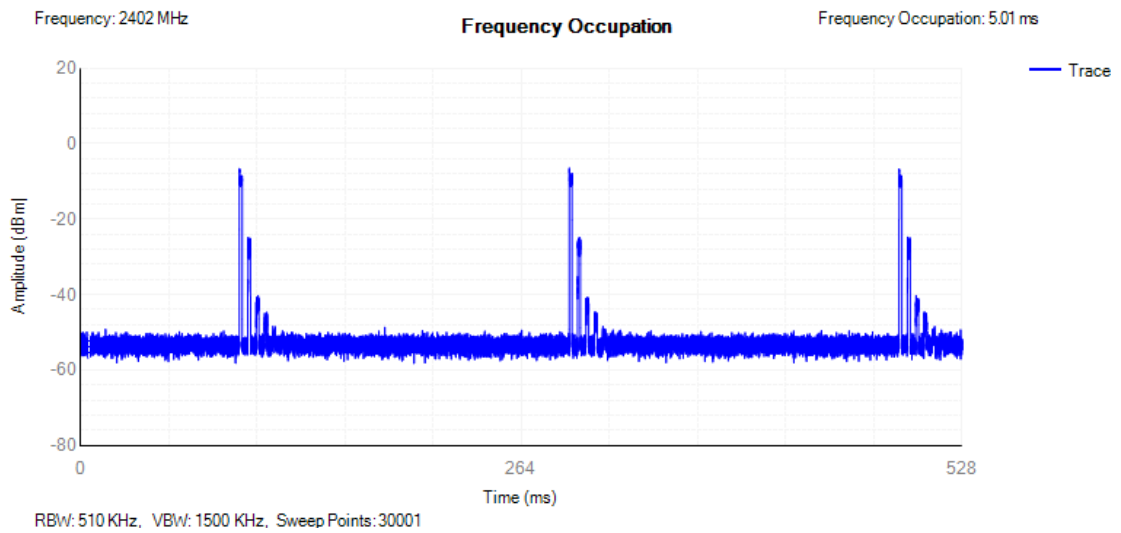
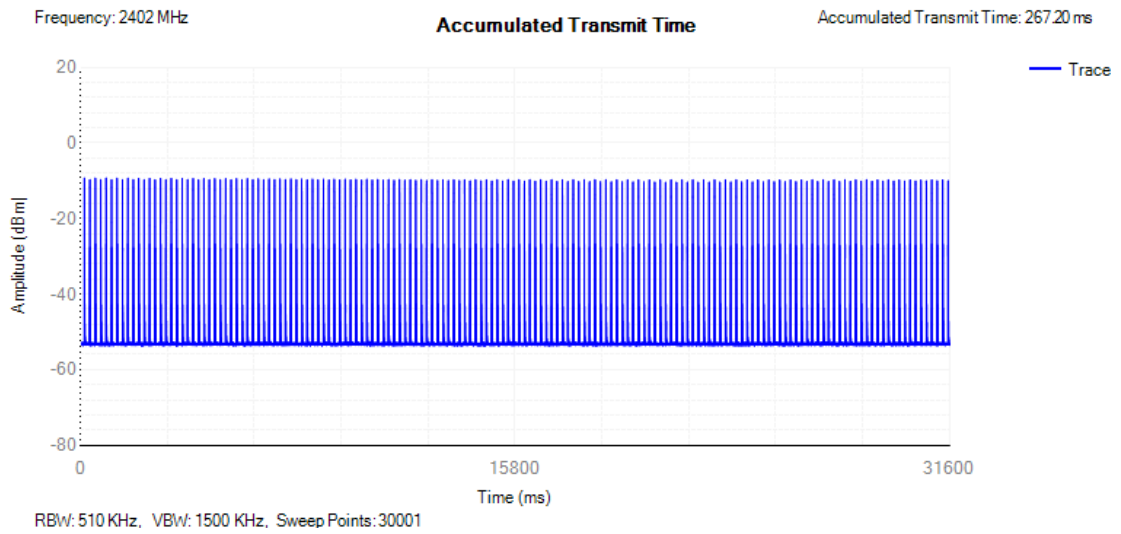

8DPSK 3-DH5

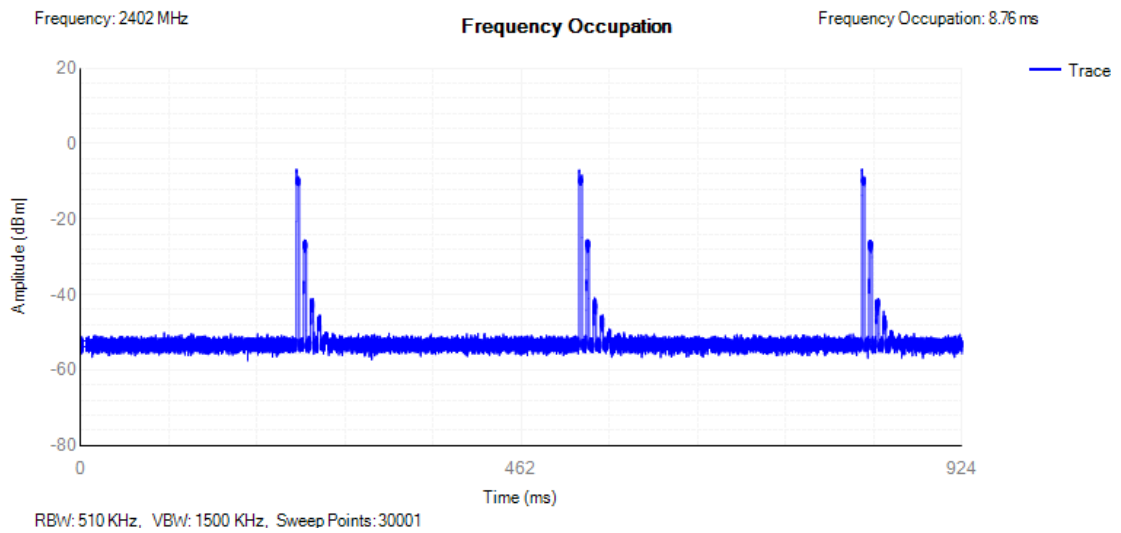
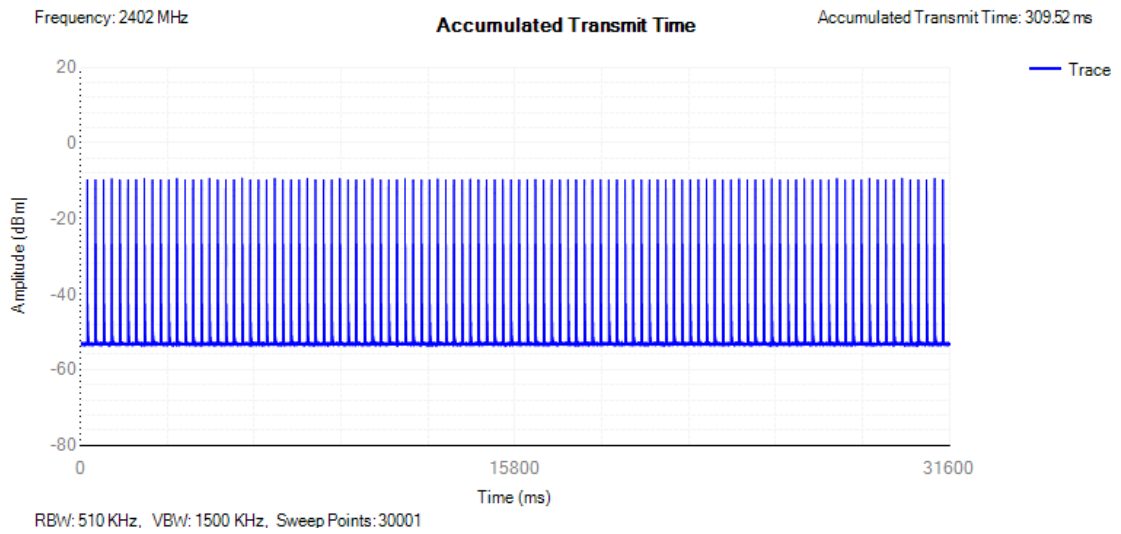

Hopping Sequence GFSK

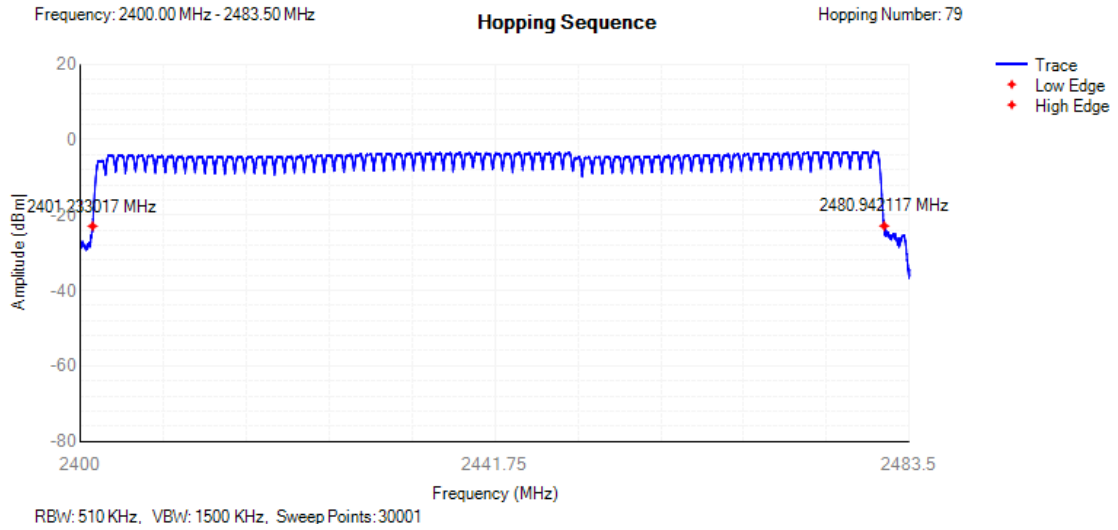

8DPSK

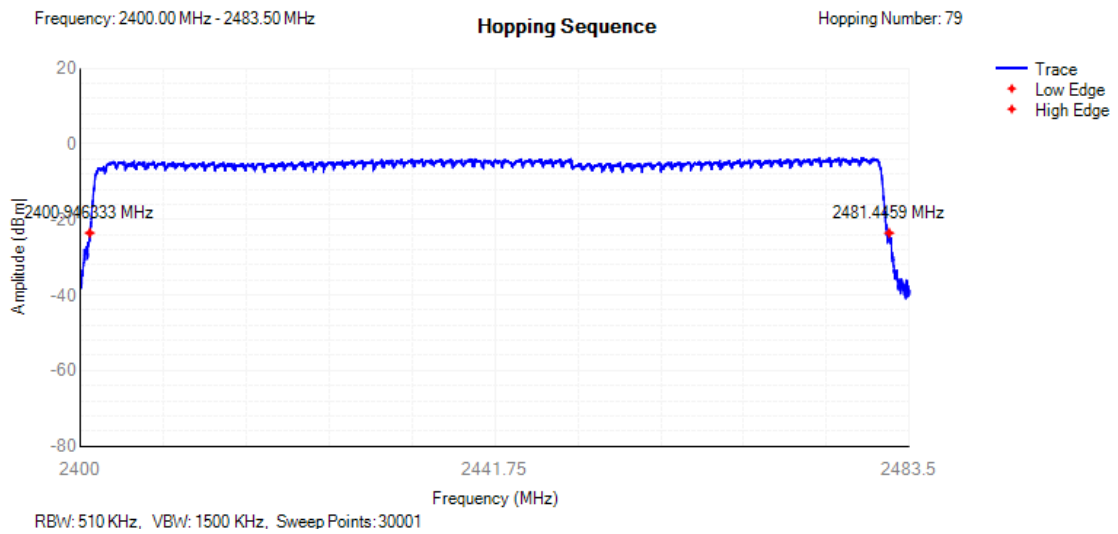

11. OCCUPIED CHANNEL BANDWIDTH

Limits

Condition	Limit
All types of equipment	Shall fall completely within the band 2400 to 2483.5 MHz
For non-adaptive using wide band modulations other than FHSS system and e.i.r.p > 10dBm	Less than 20MHz
For non-adaptive Frequency Hopping system and e.i.r.p > 10dBm	Less than 5MHz

Test Method

1. Please refer to ETSI EN 300328 (V_{2.1.1}) clause 5.4.8.2.1 for conducted measurement method.
2. The measurements shall be performed at normal environmental condition.

Test Configuration



Test Result

Pass.

Please refer to following data tables and test plots.

Temperature : 25 °C Humidity : 53%
 Test Date : June 19, 2019 Test Result: PASS
 Test By: Lee

Channel frequency (MHz)	99% Bandwidth (KHz)	FL at 99% BW (MHz)	FH at 99% BW (MHz)	Limit	Result
GFSK					
2402	841	2401.561	2402.402	FL > 2.4 GHz and FH < 2.4835 GHz	Pass
2480	841	2479.564	2480.405		Pass
8DPSK					
2402	1180	2401.385	2402.565	FL > 2.4 GHz and FH < 2.4835 GHz	Pass
2480	1178	2479.389	2480.568		Pass

Note: FL is the lowest frequency of the 99% occupied bandwidth of power envelope.
 FH is the highest frequency of the 99% occupied bandwidth of power envelope.

GFSK Lowest Channel

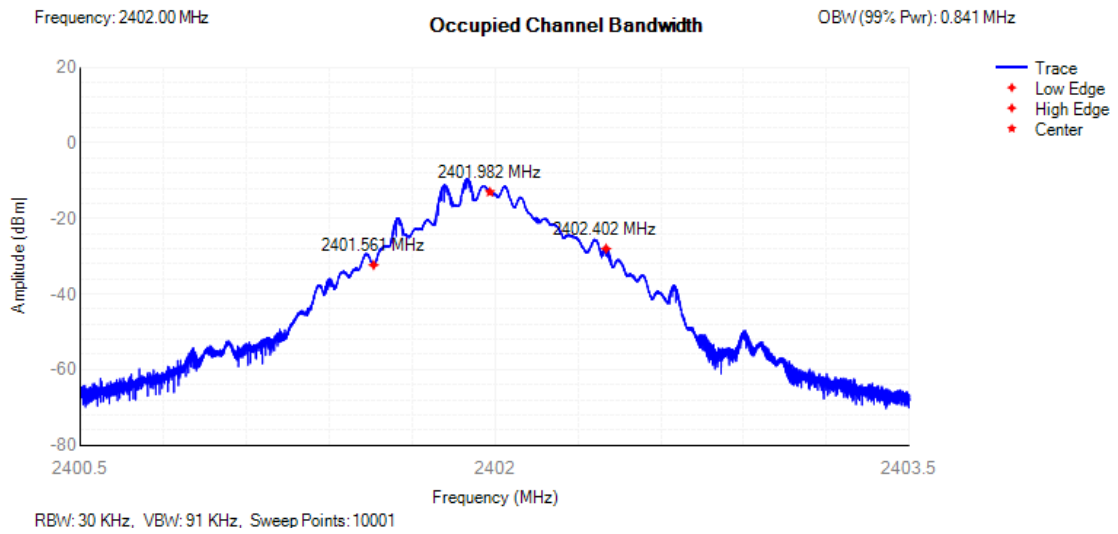

GFSK Highest Channel

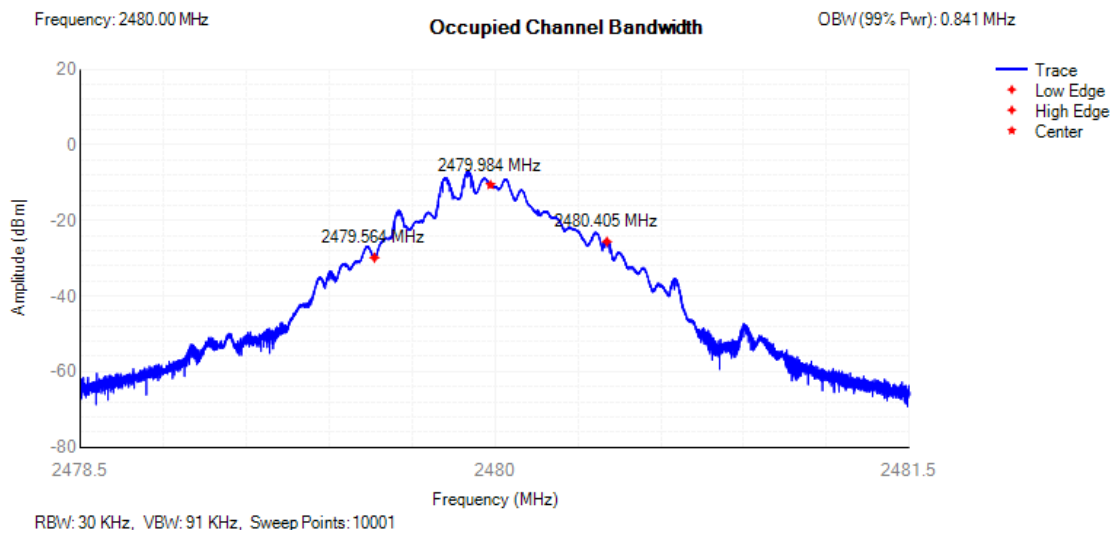

8DPSK Lowest Channel

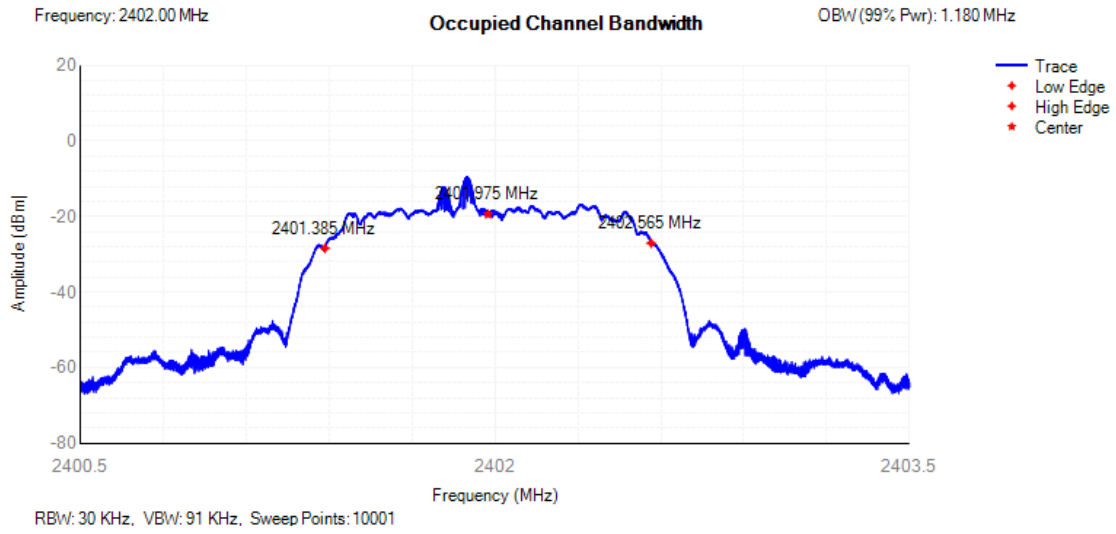

8DPSK Highest Channel

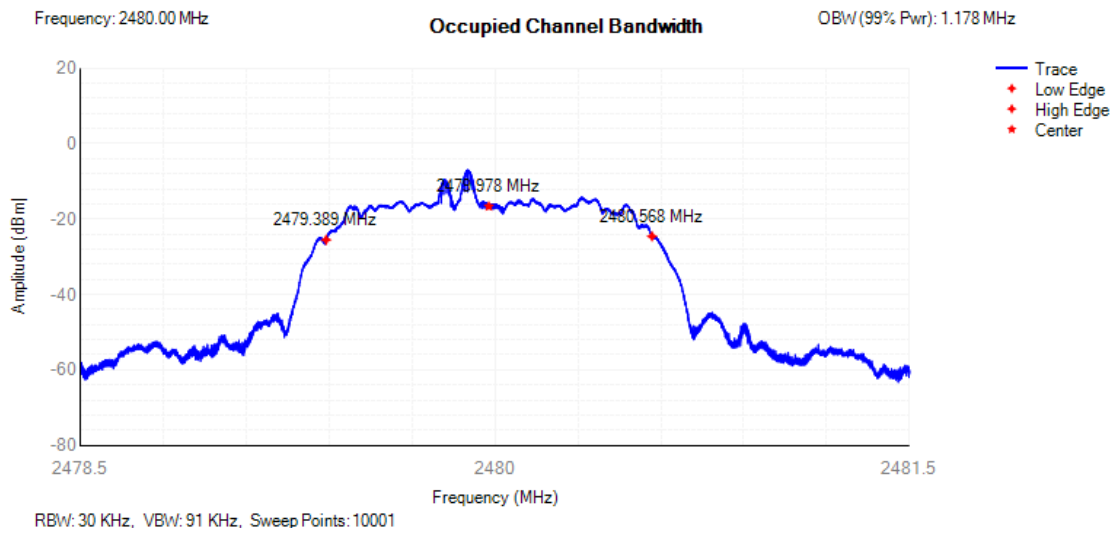

12. HOPPING FREQUENCY SEPARATION

Limits

Condition	Limit
Nom-adaptive frequency hopping systems	The minimum Hopping Frequency Separation shall be equal to Occupied Channel Bandwidth of a single hop, with a minimum separation of 100 kHz.
Adaptive frequency hopping systems	The minimum Hopping Frequency Separation shall be 100 kHz.

Test Method

1. Please refer to ETSI EN 300328 (V_{2.1.1}) clause 5.4.5.2.1 for conducted measurement method.
2. The measurements shall be performed at normal environmental condition.

Test Configuration



Test Result

Pass.

Please refer to following data tables and test plots.

Temperature : 25 °C
Test Date : June 19, 2019
Test By: Lee

Humidity : 53%
Test Result: PASS

Channel frequency (MHz)	Channel Separation (KHz)	Limit (MHz) Minimum	Result
GFSK			
2402	1000.5	0.1	Pass
2480	998.6	0.1	Pass
8DPSK			
2402	1000	0.1	Pass
2480	990	0.1	Pass

GFSK Lowest Channel

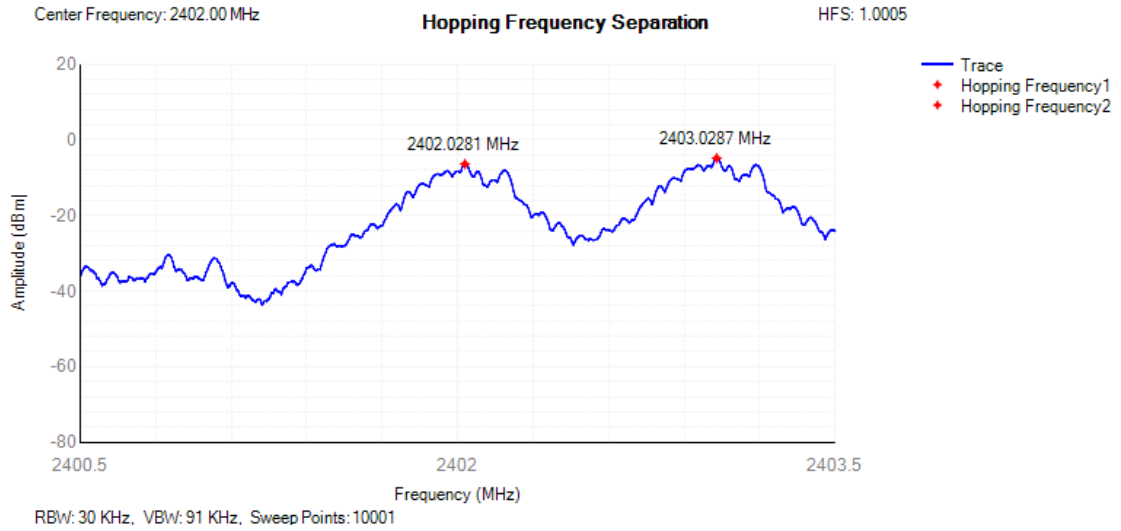

GFSK Highest Channel

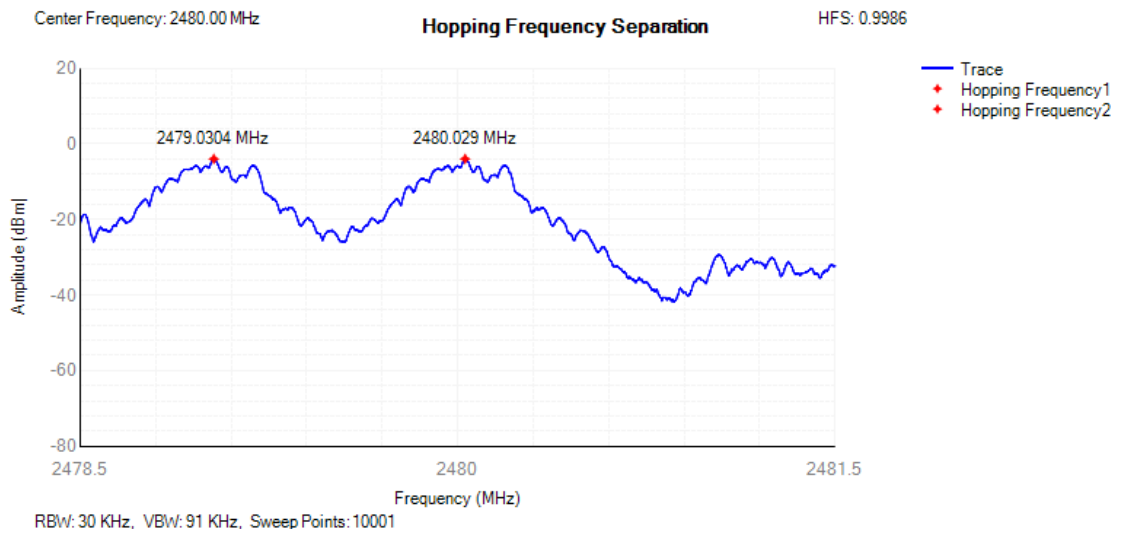

8DPSK Lowest Channel

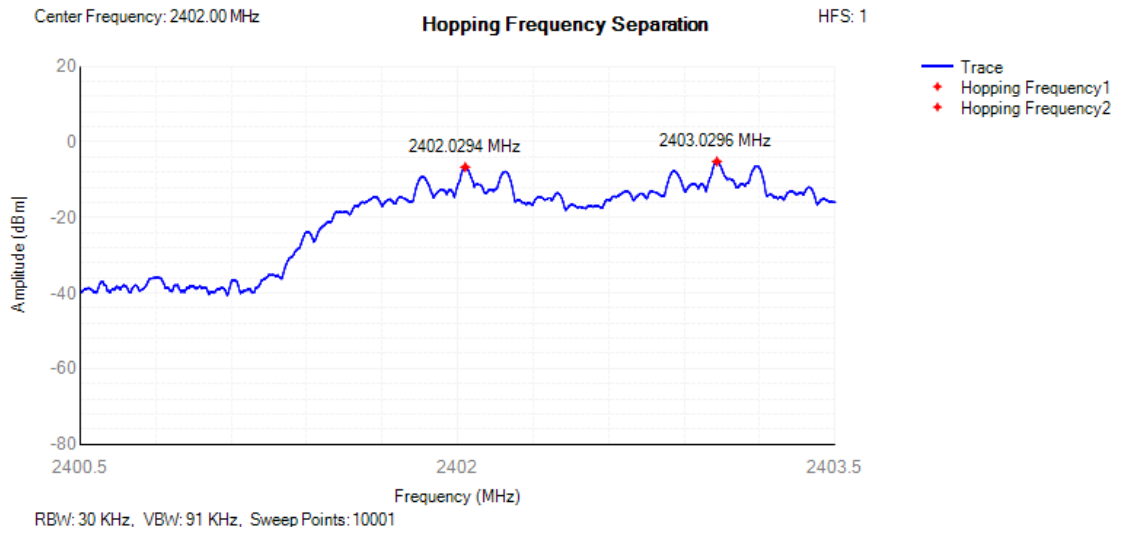

8DPSK Highest Channel

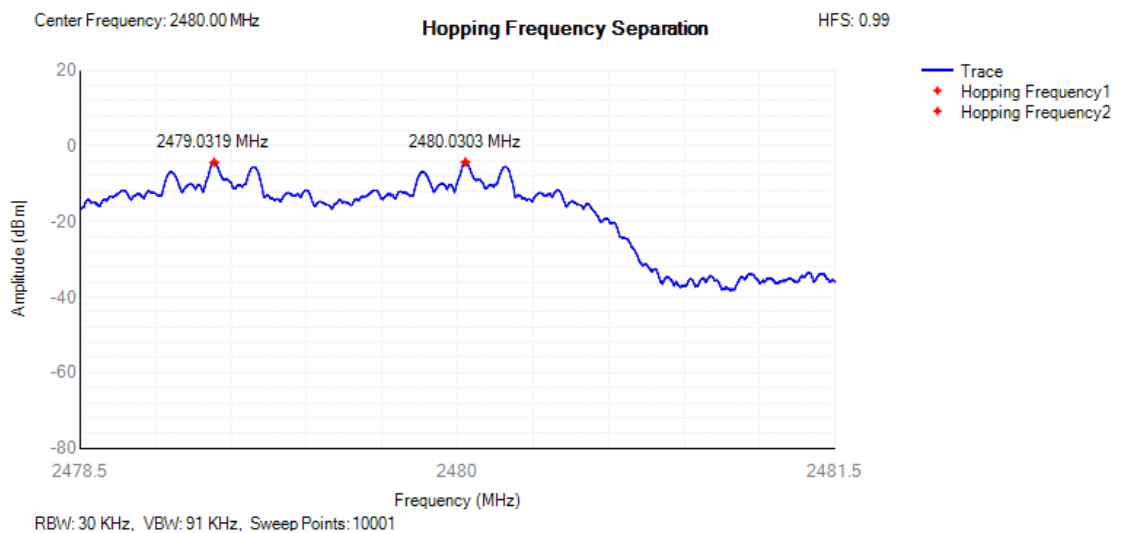

13. TRANSMITTER UNWANTED EMISSIONS IN THE OUT-OF-BAND DOMAIN

Limits

The transmitter unwanted emissions in the out-of-band domain but outside the allocated band, shall not exceed the values provided by the mask

Transmit mask

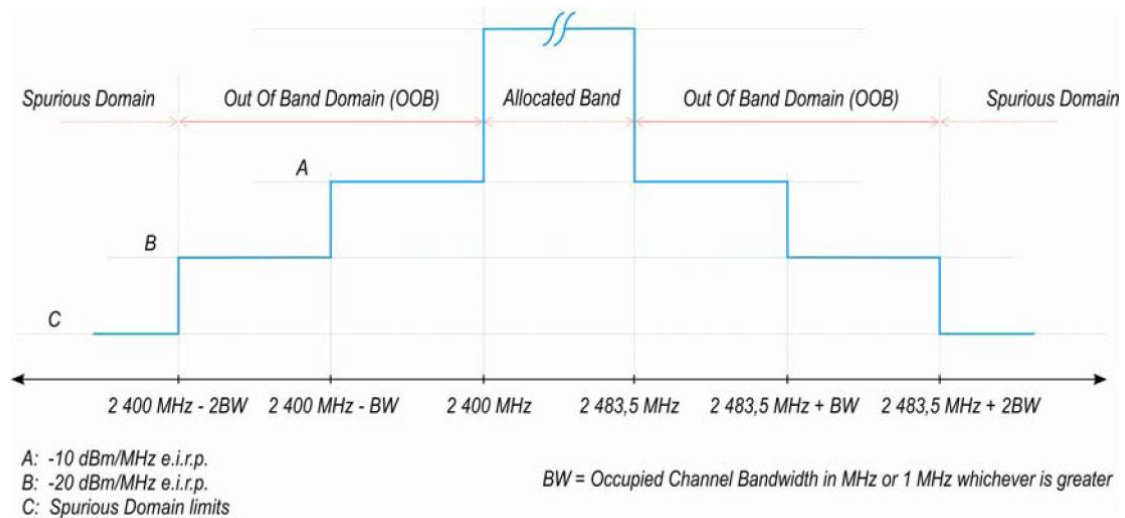

Test Method

1. Please refer to ETSI EN 300328 (V_{2.1.1}) clause 5.4.8.2.1 for conducted measurement method.
2. The measurements shall be performed at both normal environmental conditions.

Test Configuration

Temperature and Voltage Measurement

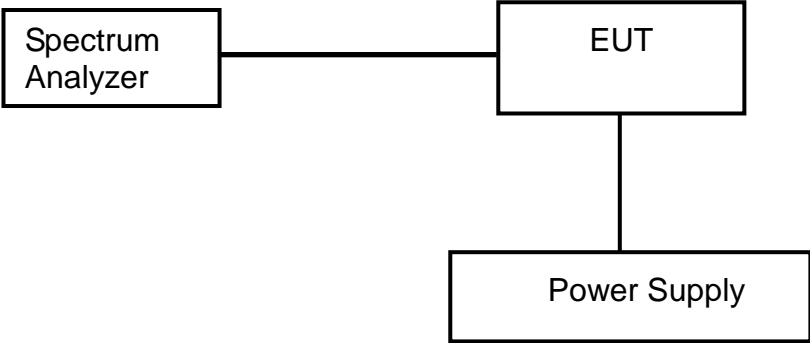

Test Result

Pass.

Please refer to following data tables.

Temperature : 25 °C
Test Date : June 19, 2019
Test By: Lee

Humidity : 53%
Test Result: PASS

Condition	2400-BW~2400 / 2483.5+BW ~2483.5 (dBm/MHz)	Limit (dBm/MHz)	2400-2*BW~2400-BW / 2483.5+2*BW ~2483.5+BW (dBm/MHz)	Limit (dBm/MHz)	Result
GFSK (Hopping)					
AC 230V	-70.84	-10	-69.46	-20	PASS
8DPSK (Hopping)					
AC 230V	-71.02	-10	-69.58	-20	PASS

14. TRANSMITTER SPURIOUS EMISSIONS

Limits:

The transmitter unwanted emissions in the spurious domain shall not exceed the values.

Frequency Range	Maximum power e.r.p. (≤ 1 GHz) e.i.r.p. (> 1 GHz)	Bandwidth
30 MHz to 47MHz	-36 dBm	100KHz
47 MHz to 74MHz	-54 dBm	100KHz
74 MHz to 87.5MHz	-36 dBm	100KHz
87.5 MHz to 118MHz	-54 dBm	100KHz
118 MHz to 174MHz	-36 dBm	100KHz
174 MHz to 230MHz	-54 dBm	100KHz
230 MHz to 470MHz	-36 dBm	100KHz
470 MHz to 862MHz	-54 dBm	100KHz
862 MHz to 1GHz	-36 dBm	100KHz
1GHz to 12.75GHz	-30 dBm	1MHz

Test Method

1. Please refer to ETSI EN 300328 (V_{2.1.1}) clause 5.4.9.2.2 for radiated measurement method.
2. The measurements shall be performed at normal environmental condition.

Test Configuration

Below 1GHz

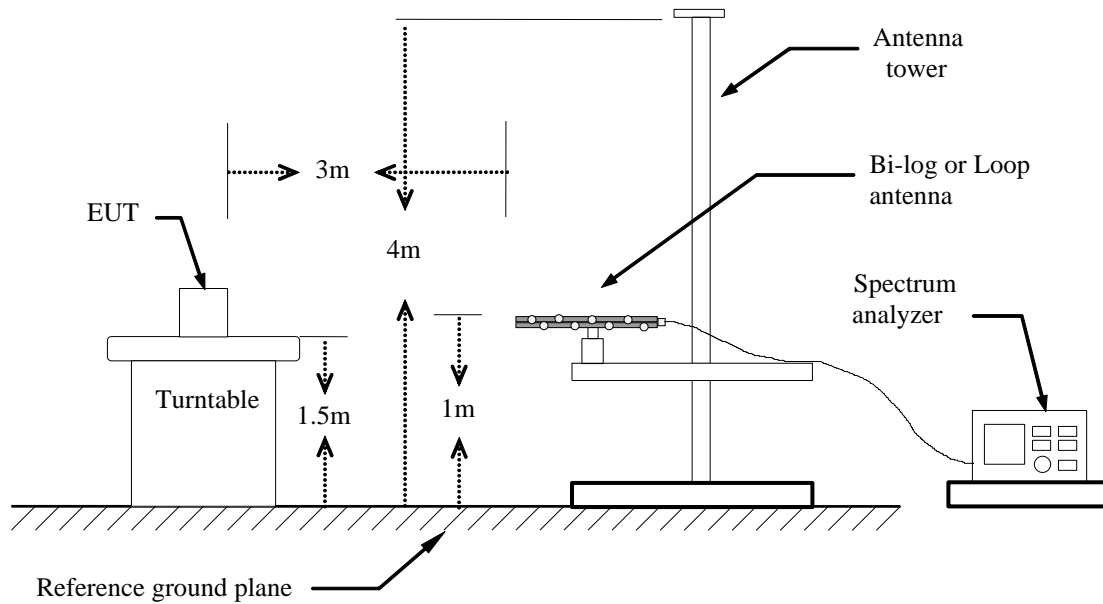

Above 1GHz

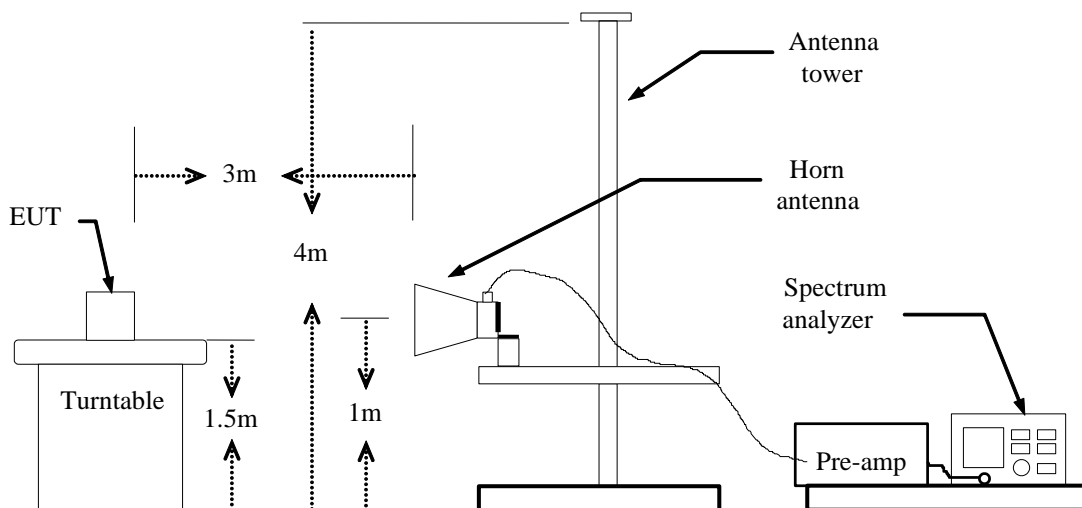

Test Result

Pass.

Please refer to following data tables of the worst case: 8DPSK .

Below 1GHz Low channel				
Humidity : 47 %		Temperature : 26 °C		
Test Result: PASS		Test By: Lee		
Test Mode: TX				
Frequency (MHz)	Antenna Polarization	Emission level (dBm)	Limit (dBm)	Margin (dB)
218.1800	Vertical	-62.77	-54.00	-8.77
229.8200	Vertical	-63.34	-54.00	-9.34

107.6000	Horizontal	-61.70	-54.00	-7.70
203.6300	Horizontal	-63.03	-54.00	-9.03

Below 1GHz High channel				
Humidity : 47 %		Temperature : 26 °C		
Test Result: PASS		Test By: Lee		
Test Mode: TX				
Frequency (MHz)	Antenna Polarization	Emission level (dBm)	Limit (dBm)	Margin (dB)
217.2100	Vertical	-62.45	-54.00	-8.45
227.8800	Vertical	63.40	-54.00	-9.40

107.6000	Horizontal	-62.23	-54.00	-8.23
202.6600	Horizontal	-63.51	-54.00	-9.51

Above 1GHz Low channel				
Humidity : 47 %		Temperature : 26 °C		
Test Result: PASS		Test By: Lee		
Test Mode: TX				
Frequency (MHz)	Antenna Polarization	Emission level (dBm)	Limit (dBm)	Margin (dB)
4804	Vertical	-44.48	-30	-14.48
7206	Vertical	-39.65	-30	-9.65

4804	Horizontal	-44.63	-30	-14.63
7206	Horizontal	-39.32	-30	-9.32

Above 1GHz High channel				
Humidity : 47 %		Temperature : 26 °C		
Test Result: PASS		Test By: Lee		
Test Mode: TX				
Frequency (MHz)	Antenna Polarization	Emission level (dBm)	Limit (dBm)	Margin (dB)
4960	Vertical	-44.91	-30	-14.91
7440	Vertical	-39.39	-30	-9.39

4960	Horizontal	-44.87	-30	-14.87
7440	Horizontal	-39.71	-30	-9.71

- Note:**
1. Emission Level (dBm) = Reading level (dBm)+Correction Factor (dB)
 2. Data of measurement within this frequency range shown “ ---” in the table above means the reading of emissions are attenuated more than 10dB below the permissible limits.
 3. The Test frequency range is 30MHz to12.75GHz.

15. RECEIVER SPURIOUS EMISSIONS

Limits

Frequency Range	Maximum power e.r.p. (≤ 1 GHz) e.i.r.p. (> 1 GHz)	Bandwidth
30 MHz to 1GHz	-57 dBm	100KHz
1GHz to 12.75GHz	-47 dBm	1MHz

Test Method

1. Please refer to ETSI EN 300328 (V_{2.1.1}) clause 5.4.10.2.2 for radiated measurement method.
2. The measurements shall be performed at normal environmental condition.

Test Configuration

Same as section 14 in this test report.

Test Result

Pass.

Please refer to following data tables of the worst case: 8DPSK.

Below 1GHz Low channel				
Humidity : 47 %		Temperature : 26 °C		
Test Result: PASS		Test By: Lee		
Test Mode: RX				
Frequency (MHz)	Antenna Polarization	Emission level (dBm)	Limit (dBm)	Margin (dB)
30.0000	Vertical	-60.95	-57.00	-3.95
224.9700	Vertical	-63.23	-57.00	-6.23

119.2400	Horizontal	-61.68	-57.00	-4.68
131.8500	Horizontal	-62.16	-57.00	-5.16

Below 1GHz High channel				
Humidity : 47 %		Temperature : 26 °C		
Test Result: PASS		Test By: Lee		
Test Mode: RX				
Frequency (MHz)	Antenna Polarization	Emission level (dBm)	Limit (dBm)	Margin (dB)
30.9700	Vertical	-61.40	-57.00	-4.40
224.0000	Vertical	-63.19	-57.00	-6.19

119.2400	Horizontal	-62.37	-57.00	-5.37
131.8500	Horizontal	-64.14	-57.00	-7.14

Above 1GHz Low channel				
Humidity : 47 %		Temperature : 26 °C		
Test Result: PASS		Test By: Lee		
Test Mode: RX				
Frequency (MHz)	Antenna Polarization	Emission level (dBm)	Limit (dBm)	Margin (dB)
2402	Vertical	-63.46	-47.00	-16.46

2402	Horizontal	-63.30	-47.00	-16.30

Above 1GHz High channel				
Humidity : 47 %		Temperature : 26 °C		
Test Result: PASS		Test By: Lee		
Test Mode: RX				
Frequency (MHz)	Antenna Polarization	Emission level (dBm)	Limit (dBm)	Margin (dB)
2480	Vertical	-63.21	-47	-16.21

2480	Horizontal	-63.05	-47	-16.05

- Note:**
1. Emission Level (dBm) = Reading level (dBm)+Correction Factor (dB)
 2. Data of measurement within this frequency range shown “ ---” in the table above means the reading of emissions are attenuated more than 10dB below the permissible limits.
 3. The Test frequency range is 30MHz to12.75GHz.

16. RECEIVER BLOCKING

Limits

Adaptive equipment using wide band modulations, shall comply with the requirements defined in clauses 4.3.1.12.3 and clauses 4.3.1.12.4 in the presence of a blocking signal with characteristics as below table.

(1) Receiver Blocking parameters for Receiver Category 1 equipment

Wanted signal mean power from companion device (dBm)	Blocking signal frequency (MHz)	Blocking signal power (dBm) (see note 2)	Type of blocking signal
Pmin + 6 dB	2 380 2 503,5	-53	CW
Pmin + 6 dB	2 300 2 330 2 360	-47	CW
Pmin + 6 dB	2 523,5 2 553,5 2 583,5 2 613,5 2 643,5 2 673,5	-47	CW

NOTE 1: Pmin is the minimum level of wanted signal (in dBm) required to meet the minimum performance criteria as defined in clause 4.3.1.12.3 in the absence of any blocking signal.
NOTE 2: The levels specified are levels in front of the UUT antenna. In case of conducted measurements, the levels have to be corrected by the actual antenna assembly gain.

(2) Receiver Blocking parameters receiver category 2 equipment

Wanted signal mean power from companion device (dBm)	Blocking signal frequency (MHz)	Blocking signal power (dBm) (see note 2)	Type of blocking signal
Pmin + 6 dB	2 380 2 503,5	-57	CW
Pmin + 6 dB	2 300 2 583,5	-47	CW

NOTE 1: Pmin is the minimum level of the wanted signal (in dBm) required to meet the minimum performance criteria as defined in clause 4.3.1.12.3 in the absence of any blocking signal.
NOTE 2: The levels specified are levels in front of the UUT antenna. In case of conducted measurements, the levels have to be corrected by the actual antenna assembly gain.

(3) Receiver Blocking parameters receiver category 3 equipment

Wanted signal mean power from companion device (dBm)	Blocking signal frequency (MHz)	Blocking signal power (dBm) (see note 2)	Type of blocking signal
Pmin + 12 dB	2 380 2 503,5	-57	CW
Pmin + 12 dB	2 300 2 583,5	-47	CW

NOTE 1: Pmin is the minimum level of the wanted signal (in dBm) required to meet the minimum performance criteria as defined in clause 4.3.1.12.3 in the absence of any blocking signal.
NOTE 2: The levels specified are levels in front of the UUT antenna. In case of conducted measurements, the levels have to be corrected by the actual antenna assembly gain.

Test Method

1. Please refer to ETSI EN 300328 (V_{2.1.1}) clause 5.4.11.2.1 for conducted measurement method.
2. The measurements shall be performed at normal environmental condition.

Test Configuration

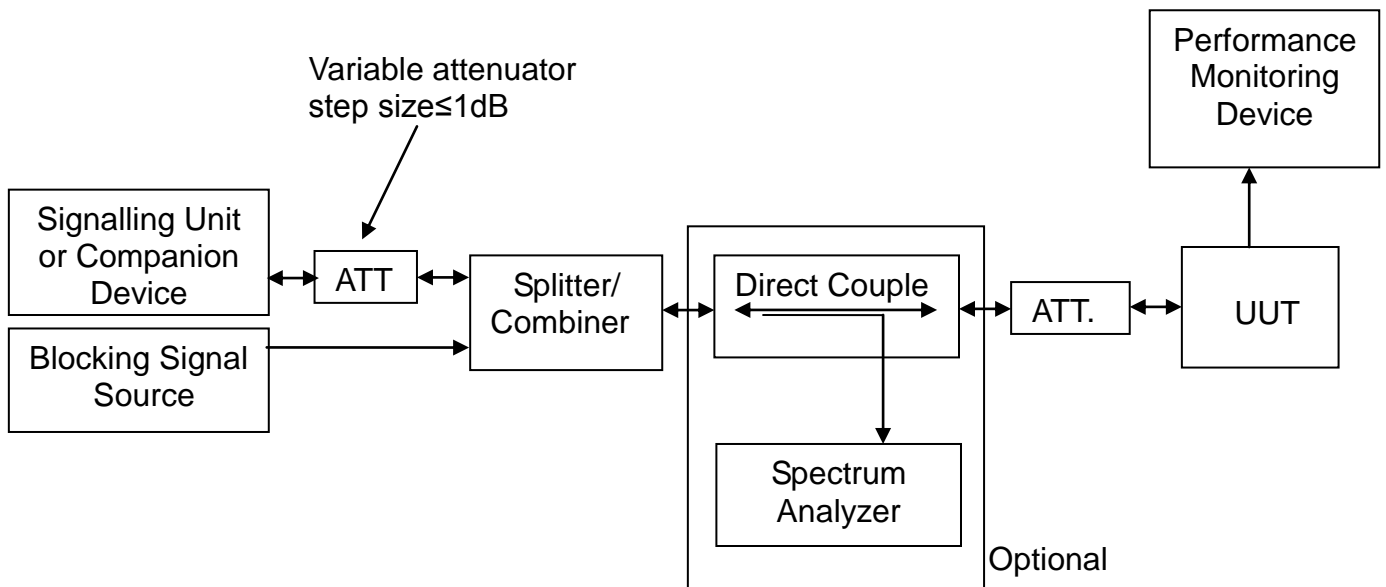

Test Result

Pass.

Please refer to following data tables.

Humidity :		52 %	Temperature :		22 °C
Test Result:		PASS	Test By		Lee
Antenna Assembly Gain:				0.5dBi	
<input type="checkbox"/> category 1		<input checked="" type="checkbox"/> category 2		<input type="checkbox"/> category 3	
Wanted signal mean power from companion device (dBm)	Blocking signal frequency (MHz)	Blocking signal power (dBm)	PER(%)	PER Limit (%)	
GFSK					
Pmin + 6 dB	2 380 2 503,5	-56.5	1.1	10	
Pmin + 6 dB	2 300 2 583,5	-46.5	1.0	10	
8DPSK					
Pmin + 6 dB	2 380 2 503,5	-56.5	1.0	10	
Pmin + 6 dB	2 300 2 583,5	-46.5	0.8	10	

17. TEST EQUIPMENT LIST

Item	Equipment	Manufacturer	Model No.	Serial No.	Last Cal.	Cal. Interval
1.	Test Receiver	Rohde & Schwarz	ESCI7	100837	Mar. 14, 2019	1 Year
2.	Antenna	Schwarzbeck	VULB9162	9162-010	Mar. 23, 2019	1 Year
3.	Spectrum Analyzer	Rohde & Schwarz	FSU26	200409/026	Mar. 14, 2019	1 Year
4.	Spectrum Analyzer	Keysight	N9020A	MY54200831	Apr. 24, 2019	1 Year
5.	Signal generator	Agilent	E4421B	MY41000708	Mar. 14, 2019	1 Year
6.	Signal generator	Agilent	N5182A	MY48180739	Mar. 14, 2019	1 Year
7.	Power Sensor	DARE	RPR3006W	15I00041SNO64	Mar. 14, 2019	1 Year
8.	Communication Tester	Rohde & Schwarz	CMW500	149004	Mar. 14, 2019	1 Year
9.	Horn Antenna	COM-Power	AH-118	071078	Mar. 23, 2019	1 Year
10.	Pre-Amplifier	HP	HP 8449B	3008A00964	Mar. 14, 2019	1 Year
11.	Pre-Amplifier	HP	HP 8447D	1145A00203	Mar. 14, 2019	1 Year
12.	Temperature & Humidity Chamber	REMAFEE	SYHR225L	N/A	Apr. 24, 2019	1 Year
13.	DC Source	Maynuo	MY8811	N/A	Mar.23,2019	1 Year
14.	Test Software	EZ	EZ_EMCC	N/A	N/A	N/A
15.	Test Software	MWRF	MWRF_V1.0	N/A	N/A	N/A

APPENDIX I

INFORMATION AS REQUIRED BY EN 300 328 V2.1.1, CLAUSE 5.4.1

In accordance with EN 300 328, clause 5.4.1, the following information is provided by the supplier.

a) The type of modulation used by the equipment:	<input checked="" type="checkbox"/> FHSS <input type="checkbox"/> other forms of modulation
b) In case of FHSS modulation:	<ul style="list-style-type: none"> In case of non-Adaptive Frequency Hopping equipment: The number of Hopping Frequencies: _____
	<ul style="list-style-type: none"> In case of Adaptive Frequency Hopping Equipment: The maximum number of Hopping Frequencies: <u>79</u> The minimum number of Hopping Frequencies: _____
	<ul style="list-style-type: none"> The (Average) Dwell Time: <u>310.445ms</u>
c) Adaptive / non-adaptive equipment:	<input type="checkbox"/> non-adaptive Equipment <input checked="" type="checkbox"/> adaptive Equipment without the possibility to switch to a non-adaptive mode <input type="checkbox"/> adaptive Equipment which can also operate in a non-adaptive mode
d) In case of adaptive equipment:	The maximum Channel Occupancy Time implemented by the equipment: _____ ms <input checked="" type="checkbox"/> The equipment has implemented an LBT based DAA mechanism
	<ul style="list-style-type: none"> In case of equipment using modulation different from FHSS: <input type="checkbox"/> The equipment is Frame Based equipment <input type="checkbox"/> The equipment is Load Based equipment <input type="checkbox"/> The equipment can switch dynamically between Frame Based and Load Based equipment
	The CCA time implemented by the equipment: _____ μ s
	<input type="checkbox"/> The equipment has implemented an non-LBT based DAA mechanism <input type="checkbox"/> The equipment can operate in more than one adaptive mode
e) In case of non-adaptive Equipment:	The maximum RF Output Power (e.i.r.p.): _____ dBm
	The maximum (corresponding) Duty Cycle: _____ %
	Equipment with dynamic behaviour, that behaviour is described here. (e.g. the different combinations of duty cycle and orresponding power levels to be declared):
f) The worst case operational mode for each of the following tests:	<ul style="list-style-type: none"> RF Output Power <u>8DPSK</u>
	<ul style="list-style-type: none"> Power Spectral Density <u>N/A</u>
	<ul style="list-style-type: none"> Duty cycle, Tx-Sequence, Tx-gap <u>N/A</u>
	<ul style="list-style-type: none"> Accumulated Transmit time, Frequency Occupation & Hopping Sequence (only for FHSS equipment) <u>GFSK</u>
	<ul style="list-style-type: none"> Hopping Frequency Separation (only for FHSS equipment) <u>GFSK</u>
	<ul style="list-style-type: none"> Medium Utilisation <u>N/A</u>
	<ul style="list-style-type: none"> Adaptivity & Receiver Blocking <u>GFSK</u>
	<ul style="list-style-type: none"> Nominal Channel Bandwidth <u>8DPSK</u>
	<ul style="list-style-type: none"> Transmitter unwanted emissions in the OOB domain <u>8DPSK</u>
	<ul style="list-style-type: none"> Transmitter unwanted emissions in the spurious domain <u>8DPSK</u>
<ul style="list-style-type: none"> Receiver spurious emissions <u>8DPSK</u> 	

g) The different transmit operating modes (tick all that apply):	<input checked="" type="checkbox"/> Operating mode 1: Single Antenna Equipment <input checked="" type="checkbox"/> Equipment with only 1 antenna <input type="checkbox"/> Equipment with 2 diversity antennas but only 1 antenna active at any moment in time <input type="checkbox"/> Smart Antenna Systems with 2 or more antennas, but operating in a (legacy) mode where only 1 antenna is used. (e.g. IEEE 802.11™ [i.3] legacy mode in smart antenna systems)
	<input type="checkbox"/> Operating mode 2: Smart Antenna Systems - Multiple Antennas without beam forming <input type="checkbox"/> Single spatial stream / Standard throughput / (e.g. IEEE 802.11™ [i.3] legacy mode) <input type="checkbox"/> High Throughput (> 1 spatial stream) using Occupied Channel Bandwidth 1 <input type="checkbox"/> High Throughput (> 1 spatial stream) using Occupied Channel Bandwidth 2 NOTE: Add more lines if more channel bandwidths are supported.
	<input type="checkbox"/> Operating mode 3: Smart Antenna Systems - Multiple Antennas with beam forming <input type="checkbox"/> Single spatial stream / Standard throughput / (e.g. IEEE 802.11™ [i.3] legacy mode) <input type="checkbox"/> High Throughput (> 1 spatial stream) using Occupied Channel Bandwidth 1 <input type="checkbox"/> High Throughput (> 1 spatial stream) using Occupied Channel Bandwidth 2 NOTE: Add more lines if more channel bandwidths are supported.
h) In case of Smart Antenna Systems:	•The number of Receive chains: _____
	•The number of Transmit chains: _____ <input type="checkbox"/> symmetrical power distribution <input type="checkbox"/> asymmetrical power distribution
	In case of beam forming, the maximum beam forming gain: _____ NOTE: Beam forming gain does not include the basic gain of a single antenna.
i) Operating Frequency Range(s) of the equipment:	•Operating Frequency Range 1: <u> 2402 </u> MHz to <u> 2480 </u> MHz •Operating Frequency Range 2: _____ MHz to _____ MHz NOTE: Add more lines if more Frequency Ranges are supported.
j) Nominal Channel Bandwidth(s):	•Nominal Channel Bandwidth 1: <u> 841 </u> KHz •Nominal Channel Bandwidth 2: <u> 1180 </u> KHz NOTE: Add more lines if more channel bandwidths are supported.
k) Type of Equipment (stand-alone, combined, plug-in radio device, etc.): Stand-alone	<input checked="" type="checkbox"/> Stand-alone <input type="checkbox"/> Combined Equipment (Equipment where the radio part is fully integrated within another type of equipment) <input type="checkbox"/> Plug-in radio device (Equipment intended for a variety of host systems) <input type="checkbox"/> Other _____

<p>l) The normal and the extreme operating conditions that apply to the equipment:</p>	<p>Normal operating conditions (if applicable): Operating temperature range: <u> 25 </u> ° C Other (please specify if applicable): Extreme operating conditions: Operating temperature range: Minimum: <u> 0 </u> ° C Maximum: <u> 35 </u> ° C Other (please specify if applicable): Minimum: <u> </u> ° C Maximum: <u> </u> ° C</p> <p>Details provided are for the:</p> <p><input checked="" type="checkbox"/> stand-alone equipment <input type="checkbox"/> combined (or host) equipment <input type="checkbox"/> test jig</p>																																								
<p>m) The intended combination(s) of the radio equipment power settings and one or more antenna assemblies and their corresponding e.i.r.p levels:</p>	<p>•Antenna Type: <input checked="" type="checkbox"/> PCB Antenna: Antenna Gain: <u> 0.5 </u> dBi If applicable, additional beamforming gain (excluding basic antenna gain): <u> </u> dB <input type="checkbox"/> Temporary RF connector provided <input type="checkbox"/> No temporary RF connector provided</p> <p><input checked="" type="checkbox"/> Dedicated Antennas (equipment with antenna connector) <input type="checkbox"/> Single power level with corresponding antenna(s) <input type="checkbox"/> Multiple power settings and corresponding antenna(s) Number of different Power Levels: <u> </u> Power Level 1: <u> </u> dBm Power Level 2: <u> </u> dBm Power Level 3: <u> </u> dBm</p> <p>NOTE 1: Add more lines in case the equipment has more power levels.. NOTE 2: These power levels are conducted power levels (at antenna connector).</p> <p>• For each of the Power Levels, provide the intended antenna assemblies, their corresponding gains (G) and the resulting e.i.r.p. levels also taking into account the beamforming gain (Y) if applicable</p> <p>Power Level 1: <u> </u> Number of antenna assemblies provided for this power level:</p> <table border="1" style="width:100%; border-collapse: collapse; text-align: center;"> <thead> <tr> <th style="width:15%;">Assembly #</th> <th style="width:20%;">Gain (dBi)</th> <th style="width:20%;">e.i.r.p.(dBm)</th> <th style="width:45%;">Part number or model name</th> </tr> </thead> <tbody> <tr><td>1</td><td></td><td></td><td></td></tr> <tr><td>2</td><td></td><td></td><td></td></tr> <tr><td>3</td><td></td><td></td><td></td></tr> <tr><td>4</td><td></td><td></td><td></td></tr> </tbody> </table> <p>Note: Add more rows in case more antenna assemblies are supported for this power level.</p> <p>Power Level 2: <u> </u> Number of antenna assemblies provided for this power level:</p> <table border="1" style="width:100%; border-collapse: collapse; text-align: center;"> <thead> <tr> <th style="width:15%;">Assembly #</th> <th style="width:20%;">Gain (dBi)</th> <th style="width:20%;">e.i.r.p.(dBm)</th> <th style="width:45%;">Part number or model name</th> </tr> </thead> <tbody> <tr><td>1</td><td></td><td></td><td></td></tr> <tr><td>2</td><td></td><td></td><td></td></tr> <tr><td>3</td><td></td><td></td><td></td></tr> <tr><td>4</td><td></td><td></td><td></td></tr> </tbody> </table> <p>Note: Add more rows in case more antenna assemblies are supported for this power level.</p>	Assembly #	Gain (dBi)	e.i.r.p.(dBm)	Part number or model name	1				2				3				4				Assembly #	Gain (dBi)	e.i.r.p.(dBm)	Part number or model name	1				2				3				4			
Assembly #	Gain (dBi)	e.i.r.p.(dBm)	Part number or model name																																						
1																																									
2																																									
3																																									
4																																									
Assembly #	Gain (dBi)	e.i.r.p.(dBm)	Part number or model name																																						
1																																									
2																																									
3																																									
4																																									

	<p>Power Level 3: _____ Number of antenna assemblies provided for this power level:</p> <table border="1" data-bbox="523 318 1422 533"> <thead> <tr> <th>Assembly #</th> <th>Gain (dBi)</th> <th>e.i.r.p.(dBm)</th> <th>Part number or model name</th> </tr> </thead> <tbody> <tr> <td>1</td> <td></td> <td></td> <td></td> </tr> <tr> <td>2</td> <td></td> <td></td> <td></td> </tr> <tr> <td>3</td> <td></td> <td></td> <td></td> </tr> <tr> <td>4</td> <td></td> <td></td> <td></td> </tr> </tbody> </table> <p>Note: Add more rows in case more antenna assemblies are supported for this power level.</p>	Assembly #	Gain (dBi)	e.i.r.p.(dBm)	Part number or model name	1				2				3				4			
Assembly #	Gain (dBi)	e.i.r.p.(dBm)	Part number or model name																		
1																					
2																					
3																					
4																					
<p>n) The nominal voltages of the stand-alone radio equipment or the nominal voltages of the combined (host) equipment or test jig in case of plug-in devices:</p>	<p>Details provided are for the: <input type="checkbox"/> stand-alone equipment <input checked="" type="checkbox"/> combined (or host) equipment <input type="checkbox"/> test jig</p> <p>Supply Voltage <input checked="" type="checkbox"/> AC mains State AC voltage <u>AC 100-240</u> V <input type="checkbox"/> DC State DC voltage _____V</p> <p>In case of DC, indicate the type of power source</p> <p><input type="checkbox"/> Internal Power Supply <input type="checkbox"/> External Power Supply or AC/DC adapter <input type="checkbox"/> Battery <input type="checkbox"/> Other: _____</p>																				
<p>o) Describe the test modes available which can facilitate testing:</p>	<p>The EUT provides TX Mode to control RF signal transmission</p>																				
<p>p) The equipment type (e.g. Bluetooth®, IEEE 802.11™ [i.3], proprietary, etc.):</p>	<p>Bluetooth®</p>																				
<p>q) If applicable, the statistical analysis referred to in clause 5.4.1 q)</p>	<p>(to be provided as separate attachment)</p>																				
<p>r) If applicable, the statistical analysis referred to in clause 5.4.1 r)</p>	<p>(to be provided as separate attachment)</p>																				
<p>s) Geo-location capability supported by the equipment:</p>	<p><input type="checkbox"/> Yes <input type="checkbox"/> The geographical location determined by the equipment as defined in clause 4.3.1.13.2 or clause 4.3.2.12.2 is not accessible to the user <input type="checkbox"/> No</p>																				
<p>t) Describe the minimum performance criteria that apply to the equipment (see clause 4.3.1.12.3 or clause 4.3.2.11.3):</p>																					



E.3 Combination for testing	Highest overall e.i.r.p. value: <u> 4.01 </u> dBm
	Corresponding Antenna assembly gain: <u> 0.5 </u> dBi
	Corresponding conducted power setting: (also the power level to be used for testing) _____ dBm
	Antenna Assembly # _____
	Listed as Power Setting #: _____
E.4 Additional information provided by the applicant	
E.4.1 Modulation:	ITU Class(es) of emission: <u> FHSS </u> Can the transmitter operate unmodulated? <input checked="" type="checkbox"/> yes <input type="checkbox"/> no
E.4.2 Duty Cycle	The transmitter is intended for: <input type="checkbox"/> Continuous duty <input type="checkbox"/> Intermittent duty <input checked="" type="checkbox"/> Continuous operation possible for testing purposes
E.4.3 About the UUT	<input checked="" type="checkbox"/> The equipment submitted are representative production models <input type="checkbox"/> If not, the equipment submitted are pre-production models ? <input type="checkbox"/> If pre-production equipment are submitted, the final production equipment will be identical in all respects with the equipment tested <input type="checkbox"/> If not, supply full details
E.4.4 Additional items and/or supporting equipment provided	<input type="checkbox"/> Spare batteries (e.g. for portable equipment) <input type="checkbox"/> Battery charging device <input type="checkbox"/> External Power Supply or AC/DC adapter <input type="checkbox"/> Test Jig or interface box <input type="checkbox"/> RF test fixture (for equipment with integrated antennas) <input type="checkbox"/> Host System Manufacturer: _____ Model #: _____ Model name: _____ <input type="checkbox"/> Combined equipment Manufacturer: _____ Model #: _____ Model name: _____ <input checked="" type="checkbox"/> User Manual <input checked="" type="checkbox"/> Technical documentation (Handbook and circuit diagrams)

APPENDIX II

PHOTOGRPHS OF TEST SETUP

Radiated Emission Below 1 GHz



Radiated Emission Above 1 GHz

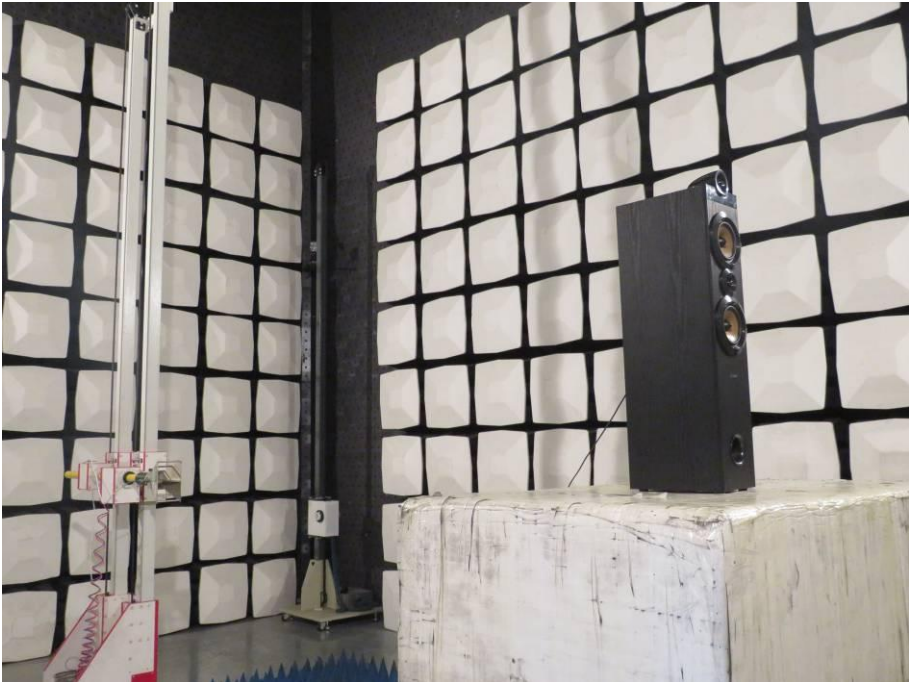

---End---