

EMC TEST REPORT

The device described below is tested by Dongguan Nore Testing Center Co., Ltd. to determine the maximum emission levels emanating from the device, the severe levels which the device can endure and E.U.T.'s performance criterion. The test results are contained in this test report. Dongguan Nore Testing Center Co., Ltd. is assumed of full responsibility for the accuracy and completeness of these tests.

Applicant : SHENZHEN FENDA TECHNOLOGY CO., LTD.
Address : Fenda Hi-Tech Park, Zhoushi Road, Shiyuan Town, Baoan District, Shenzhen City, Guangdong, China
Manufacturer /Factory : SHENZHEN FENDA TECHNOLOGY CO., LTD.
Address : Fenda Hi-Tech Park, Zhoushi Road, Shiyuan Town, Baoan District, Shenzhen City, Guangdong, China
E.U.T. : Bluetooth Speaker
Brand Name : F&D, Micromax
Model No. : W6T, W6, W6M, MBT5WSF, MBTW6T
(For model difference refer to section 2.1)
Measurement Standard : EN 55032: 2015
EN 55020: 2007+A11: 2011
(EN 61000-4-2: 2009)
Date of Receiver : February 28, 2017
Date of Test : March 01, 2017 to May 02, 2017
Date of Report : May 02, 2017

This Test Report is Issued Under the Authority of :

Prepared by

Approved & Authorized Signer

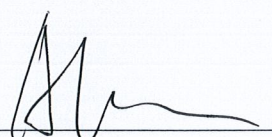
Alina Guo / Engineer
Lori Fan / Authorized Signatory

This report shows that the E.U.T. is technically compliant with the EN 55032, EN 61000-3-2, EN 61000-3-3 and EN 55020. This report applies to above tested sample only and shall not be reproduced in part without written approval of Dongguan Nore Testing Center Co., Ltd.

TABLE OF CONTENT

1. SUMMARY OF TEST RESULTS	4
2. GENERAL INFORMATION.....	5
2.1 Details of E.U.T.....	5
2.2 Description of Support Device	6
2.3 Block Diagram of Test Setup	6
2.4 Test Facility.....	7
2.5 Abnormalities from Standard Conditions	7
3. MEASURING DEVICES AND TEST EQUIPMENT	8
3.1 For Mains terminals Disturbance voltage test.....	8
3.2 For Radiated Emission Measurement	8
3.3 For Electrostatic Discharge Immunity Test	8
3.4 For EN55020 Immunity Test.....	9
4. MAINS TERMINAL DISTURBANCE VOLTAGE MEASUREMENT	10
4.1 Block Diagram of Test Setup	10
4.2 Limit of Mains Terminal Disturbance voltage measurement	10
4.3 Test Procedure	11
4.4 Operating Condition of E.U.T.....	11
4.5 Mains Terminal Disturbance Voltage Test Results	11
5. RADIATED EMISSION MEASUREMENT	14
5.1 Block Diagram of Test	14
5.2 Limit of Radiated Emission Measurement	14
5.3 Test Procedure	15
5.4 Operating Condition of E.U.T.....	15
5.5 Radiated Emission Measurement Result	15
6. PERFORMANCE CRITERIA FOR IMMUNITY	18
7. ELECTROSTATIC DISCHARGE IMMUNITY TEST	19
7.1 Block Diagram of Test Setup	19
7.2 Test Standard and Severity Levels	19
7.3 Test Procedure	20
7.4 Test Results.....	20
8. RF VOLTAGES IMMUNITY TEST(S2).....	22
8.1 Test setup	22
8.2 Test Standard and Limits	24
8.3 Test Result.....	24
9. PHOTOGRAPHS	26
9.1 Photo of Power Line Conducted Emission Measurement	26
9.2 Photo of Radiated Emission Measurement	26
9.3 Photo of Electrostatic Discharge Immunity Measurement	27
9.4 Photo of S2 Measurement.....	27

APPENDIX I (Photos of the E.U.T.) (7 pages)

Revision History of This Test Report

Report Number	Description	Issued Date
NTC1702260EV00	Initial Issue	2017-05-02

1. SUMMARY OF TEST RESULTS

The E.U.T. has been tested according to the following specifications:

EMISSION			
Standard	Test Type	Result	Remarks
EN 55032: 2015	Mains Terminal Disturbance Voltage Test	PASS	Uncertainty: 2.7dB
	Antenna Terminal Disturbance Voltage Test	N/A	Not Applicable
	Radiated Emission Test	PASS	Uncertainty: 3.4dB

IMMUNITY(EN 55020: 2007+A11: 2011)			
Standard	Test Type	Result	Remarks
EN 55020: 2007+A11: 2011	Input immunity (S1)	N/A	Not Applicable
	Immunity from conducted voltages (S2a)	PASS	Meets the requirements.
	Immunity from conducted currents (S2b)	N/A	Not Applicable
	Immunity from radiated fields (S3)	N/A	Not Applicable
	Screening effectiveness (S4)	N/A	Not Applicable
EN 61000-4-2: 2009	Electrostatic discharge immunity test	PASS	Meets the requirements of Performance Criterion B

2. GENERAL INFORMATION

2.1 Details of E.U.T.

E.U.T.	: Bluetooth Speaker
Model No.	: W6T, W6, W6M, MBT5WSF, MBTW6T All tests were carried on model W6T.
Brand Name	: F&D, Micromax
E.U.T. Class	: Class B
Operation Frequency	: Below 108MHz (Except for BT function)
Rating	: DC 5V From USB Port DC 3.7V From Li-ion battery
Adapter	: None
Test Voltage	: AC 230V 50Hz(Adapter input), DC 3.7V From battery Only the worst case was recorded in this report.
Cable	: None
Description of model difference	: These models have the same circuit schematic, construction, PCB Layout and critical components. Their difference in model number and brand name due to trading purpose.
Remark	: None

2.2 Description of Support Device

iPod	:	Manufacturer: Apple M/N: A1446 S/N: DCYNV5EMFOGQ
iPhone	:	Manufacturer: APPLE M/N: MD298CH/A S/N: DNQK31HEDTWF
Adapter	:	Model: S0500060-3C Input: AC100-240V 50/60Hz 150mA Output: DC 5.0V 600mA

2.3 Block Diagram of Test Setup

Block diagram of connection between the E.U.T. and simulators

(1) AUX IN



(2) Charging+AUX IN



(3) TF Card Playing

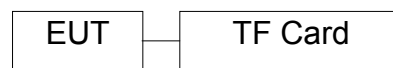

(4) Charging+TF Card Playing



2.4 Test Facility

Site Description	
EMC Lab	: Listed by CNAS, August 14, 2015 The certificate is valid until August 13, 2018 The Laboratory has been assessed and proved to be in compliance with CNAS/CL01 The Certificate Registration Number is L5795. Listed by FCC, July 03, 2014 The Certificate Number is 665078. Listed by Industry Canada, June 18, 2014 The Certificate Registration Number. Is 46405-9743
Name of Firm 1	: Dongguan Nore Testing Center Co., Ltd. (Dongguan NTC Co., Ltd.)
Site Location 1	: Building D, Gaosheng Science & Technology Park, Zhouxi Longxi Road, Nancheng District, Dongguan City, Guangdong Province, China
Name of Firm 2	: Bureau Veritas Shenzhen Co., Ltd., Dongguan Branch
Site Location 2	: No. 34, Chenwulu Section, Guantai Rd., Houjie Town, Dongguan City, Guangdong 523942, China

2.5 Abnormalities from Standard Conditions

None

3. MEASURING DEVICES AND TEST EQUIPMENT

3.1 For Mains terminals Disturbance voltage test

Item	Equipment	Manufacturer	Model No.	Serial No.	Last Cal.	Cal. Interval
1.	Test Receiver	Rohde & Schwarz	ESCI	101152	Mar. 07, 2017	1 Year
2.	L.I.S.N	Rohde & Schwarz	ENV 216	101317	Mar. 07, 2017	1 Year
3.	L.I.S.N	Schwarzbeck	NNLK8129	8129-212	Mar. 07, 2017	1 Year
4.	RF Switching Unit	Compliance Direction Systems Inc.	RSU-M2	38311	Mar. 07, 2017	1 Year

3.2 For Radiated Emission Measurement

Item	Equipment	Manufacturer	Model No.	Serial No.	Last Cal.	Cal. Interval
1.	Test Receiver	Rohde & Schwarz	ESCI7	100837	Mar. 07, 2017	1 Year
2.	Antenna	Schwarzbeck	VULB9162	9162-010	Apr. 25, 2017	1 Year
3.	Positioning Controller	UC	UC 3000	N/A	N/A	N/A
4.	Color Monitor	SUNSP0	SP-140A	N/A	N/A	N/A
5.	Single Phase Power Line Filter	SAEMC	PF201A-32	110210	N/A	N/A
6.	3 Phase Power Line Filter	SAEMC	PF401A-200	110318	N/A	N/A
7.	DC Power Filter	SAEMC	PF301A-200	110245	N/A	N/A
8.	Cable	Huber+Suhner	CBL3-NN-9M	21490001	Mar. 07, 2017	1 Year
9.	Cable	Huber+Suhner	RG223U	N/A	Mar. 07, 2017	1 Year
10.	Power Amplifier	HP	HP 8447D	1145A00203	Mar. 07, 2017	1 Year

3.3 For Electrostatic Discharge Immunity Test

Item	Equipment	Manufacturer	Model No.	Serial No.	Last Cal.	Cal. Interval
1.	ESD Tester	TESEQ	NSG 437	432	Apr. 26, 2017	1 Year

3.4 For EN55020 Immunity Test

(Bureau Veritas Shenzhen Co., Ltd., Dongguan Branch)

Item	Equipment	Manufacturer	Model No.	Serial No.	Last Cal.	Cal. Interval
1.	Broadcast System Test	Rohde&Schwarz	SFU	101543	May 14, 2016	1 Year
2.	TV Generator PAL	Rohde&Schwarz	SGPF	100200	May 14, 2016	1 Year
3.	Spectrum Analyzer	Rohde&Schwarz	FSL3	101507	May 14, 2016	1 Year
4.	Signal Generator	Rohde&Schwarz	SMB100A	102382	May 14, 2016	1 Year
5.	Signal Generator	Rohde&Schwarz	SMB100A	102383	May 14, 2016	1 Year
6.	Power Meter	Rohde&Schwarz	NRVS	101732	May 14, 2016	1 Year
7.	Audio Analyzer	Rohde&Schwarz	UPV	101346	May 14, 2016	1 Year
8.	Level Meter	Rohde&Schwarz	URV35	100335	May 14, 2016	1 Year
9.	100V Insertion Unit 50Ω	Rohde&Schwarz	URV5-Z4	100207	May 14, 2016	1 Year
10.	RF Probe	Rohde&Schwarz	URV5-Z7	100657	May 14, 2016	1 Year
11.	Absorbing Clamp	Rohde&Schwarz	MDS-21	100352	May 14, 2016	1 Year
12.	Test Software	Rohde&Schwarz	T80-K1	N/A	N/A	N/A

4. MAINS TERMINAL DISTURBANCE VOLTAGE MEASUREMENT

4.1 Block Diagram of Test Setup

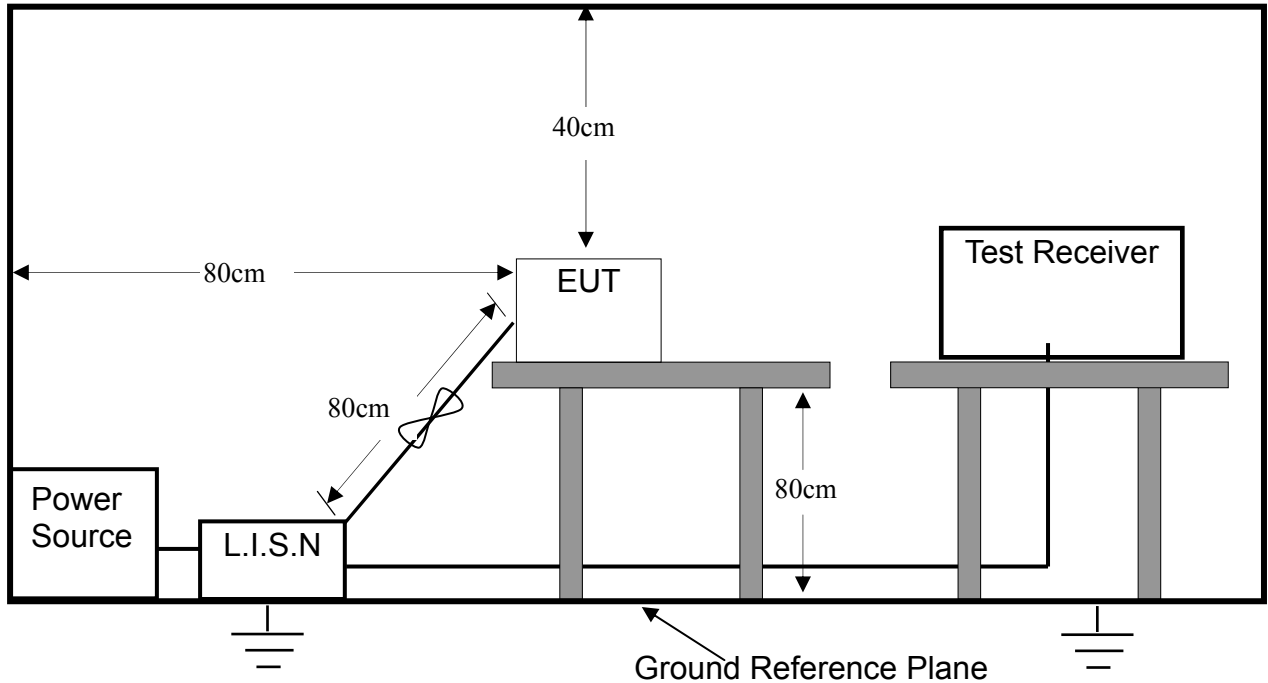

4.2 Limit of Mains Terminal Disturbance voltage measurement

Test Standard: EN 55032

Frequency range (MHz)	Limits (dB(uV))	
	Quasi-peak	Average
0.15 to 0.5	66 to 56*	56 to 46*
0.5 to 5	56	46
5 to 30	60	50

*Decreasing linearly with the logarithm of the frequency.

- Note:
1. If the limits for the average detector are met when using the quasi-peak detector, then the limits for the measurements with the average detector are considered to be met.
 2. The higher value measured with and without the outer conductor screen of the antenna terminal connected to earth is considered.
 3. Television receivers with teletext facilities should be tested in teletext mode with teletext picture.

4.3 Test Procedure

The E.U.T. is put on the 0.8 m high table and connected to the AC mains through a Artificial Mains Network (AMN). This provided a 50ohm coupling impedance for the tested equipments. Both sides of AC line are checked to find out the maximum conducted emission levels according to the EN 55032 regulations during conducted emission test.

The bandwidth of the test receiver (R&S Test Receiver ESCI) is set at 9 KHz.

4.4 Operating Condition of E.U.T.

4.4.1 Setup the E.U.T. and simulators as shown in Section 2.3.

4.4.2 Turn on the power of all equipments.

4.4.3 Let the E.U.T. work in test modes (Charging+TF Card Playing, Charging+AUX IN) and test it.

4.5 Mains Terminal Disturbance Voltage Test Results

PASS.

Please refer to the following pages of the worst case: Charging+AUX IN.



Dongguan NTC Co., Ltd.
 Tel: +86-769-22022444 Fax: +86-769-22022799
 Web: [Http://www.ntc-c.com](http://www.ntc-c.com)

Site: Conduction

Test Time: 2017-4-10 16:37:47

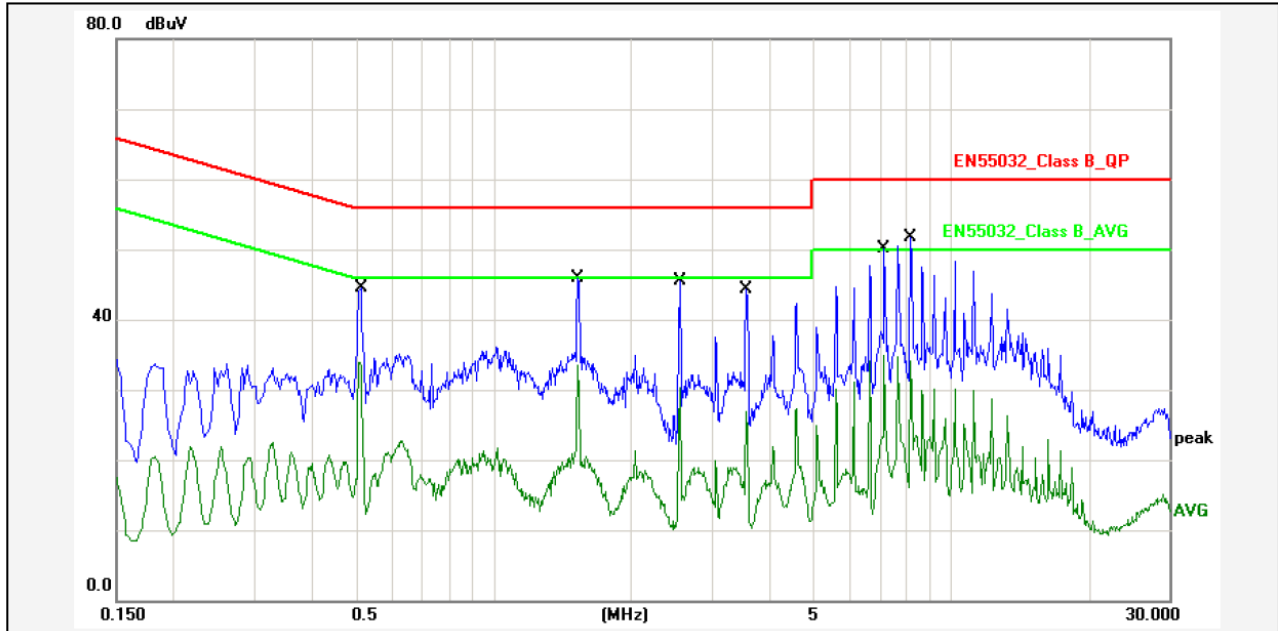

Report No.: W6T
 Test Standard: EN55032_Class B_QP
 Test item: Conducted Emission
 Applicant: FENDA
 Product: Bluetooth Speaker
 Model No.: W6T
 Phase: L1
 Temp.()/Hum.(%): 20(C) / 53 %
 Power Rating: AC 230V/50Hz
 Test Engineer: Lueng

Test Mode: Charging+AUX IN
 Remark:

No.	Frequency (MHz)	Factor (dBuV)	Reading (dBuV)	Level (dBuV)	Limit (dBuV)	Margin (dB)	Detector	P/F	Remark
1	0.5140	10.80	30.70	41.50	56.00	-14.50	QP	P	
2	0.5140	10.80	20.30	31.10	46.00	-14.90	AVG	P	
3	1.5339	10.80	32.00	42.80	56.00	-13.20	QP	P	
4	1.5339	10.80	19.60	30.40	46.00	-15.60	AVG	P	
5	2.5540	10.80	31.70	42.50	56.00	-13.50	QP	P	
6	2.5540	10.80	16.40	27.20	46.00	-18.80	AVG	P	
7	3.5820	10.80	30.50	41.30	56.00	-14.70	QP	P	
8	3.5820	10.80	13.30	24.10	46.00	-21.90	AVG	P	
9	7.1499	10.80	36.40	47.20	60.00	-12.80	QP	P	
10	7.1499	10.80	20.90	31.70	50.00	-18.30	AVG	P	
11	8.1737	10.80	37.80	48.60	60.00	-11.40	QP	P	
12	8.1737	10.80	20.30	31.10	50.00	-18.90	AVG	P	

Note: Level=Reading+Factor.
 Margin=Limit-Level.



Dongguan NTC Co., Ltd.
Tel: +86-769-22022444 Fax: +86-769-22022799
Web: [Http://www.ntc-c.com](http://www.ntc-c.com)

Site: Conduction

Test Time: 2017-4-10 16:30:10

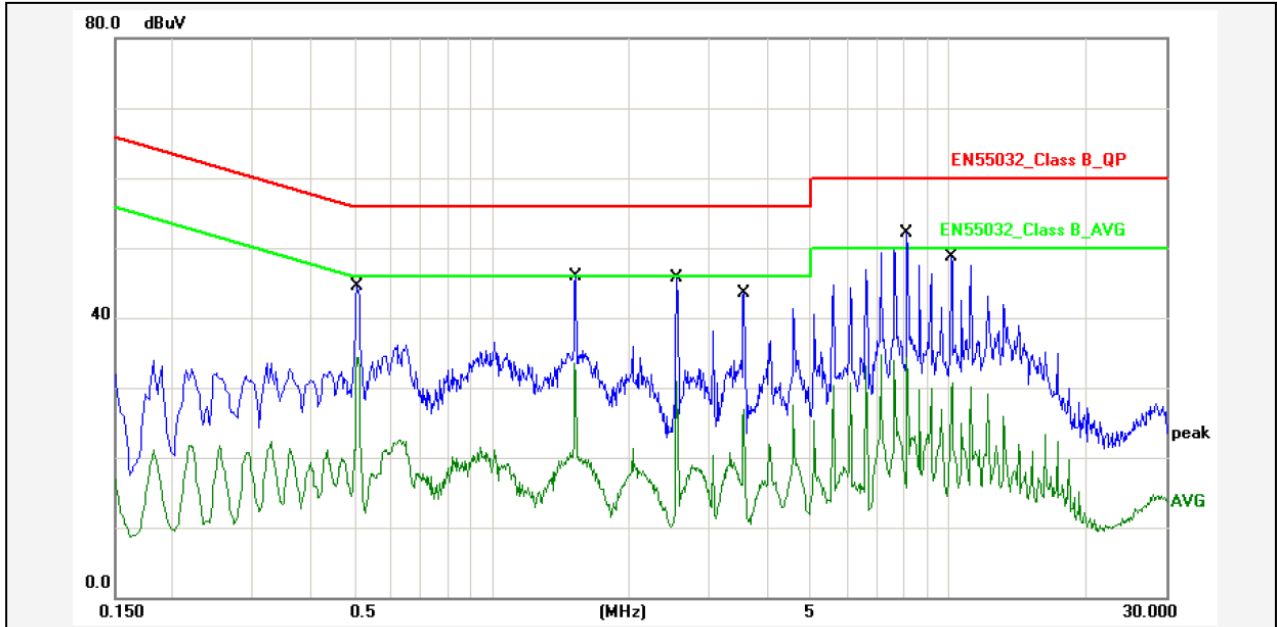

Report No.:	W6T	Phase:	N
Test Standard:	EN55032_Class B_QP	Temp.()/Hum.(%):	20(C) / 53 %
Test item:	Conducted Emission	Power Rating:	AC 230V/50Hz
Applicant:	FENDA	Test Engineer:	Lueng
Product:	Bluetooth Speaker		
Model No.:	W6T		
Test Mode:	Charging+AUX IN		
Remark:			

No.	Frequency (MHz)	Factor (dBuV)	Reading (dBuV)	Level (dBuV)	Limit (dBuV)	Margin (dB)	Detector	P/F	Remark
1	0.5100	10.80	30.60	41.40	56.00	-14.60	QP	P	
2	0.5100	10.80	20.60	31.40	46.00	-14.60	AVG	P	
3	1.5300	10.80	32.00	42.80	56.00	-13.20	QP	P	
4	1.5300	10.80	22.70	33.50	46.00	-12.50	AVG	P	
5	2.5460	10.80	31.80	42.60	56.00	-13.40	QP	P	
6	2.5460	10.80	16.70	27.50	46.00	-18.50	AVG	P	
7	3.5660	10.80	29.50	40.30	56.00	-15.70	QP	P	
8	3.5660	10.80	13.10	23.90	46.00	-22.10	AVG	P	
9	8.1418	10.80	38.30	49.10	60.00	-10.90	QP	P	
10	8.1418	10.80	30.50	41.30	50.00	-8.70	AVG	P	
11	10.1779	10.80	34.90	45.70	60.00	-14.30	QP	P	
12	10.1779	10.80	17.10	27.90	50.00	-22.10	AVG	P	

Note: Level=Reading+Factor.
Margin=Limit-Level.

5. RADIATED EMISSION MEASUREMENT

5.1 Block Diagram of Test

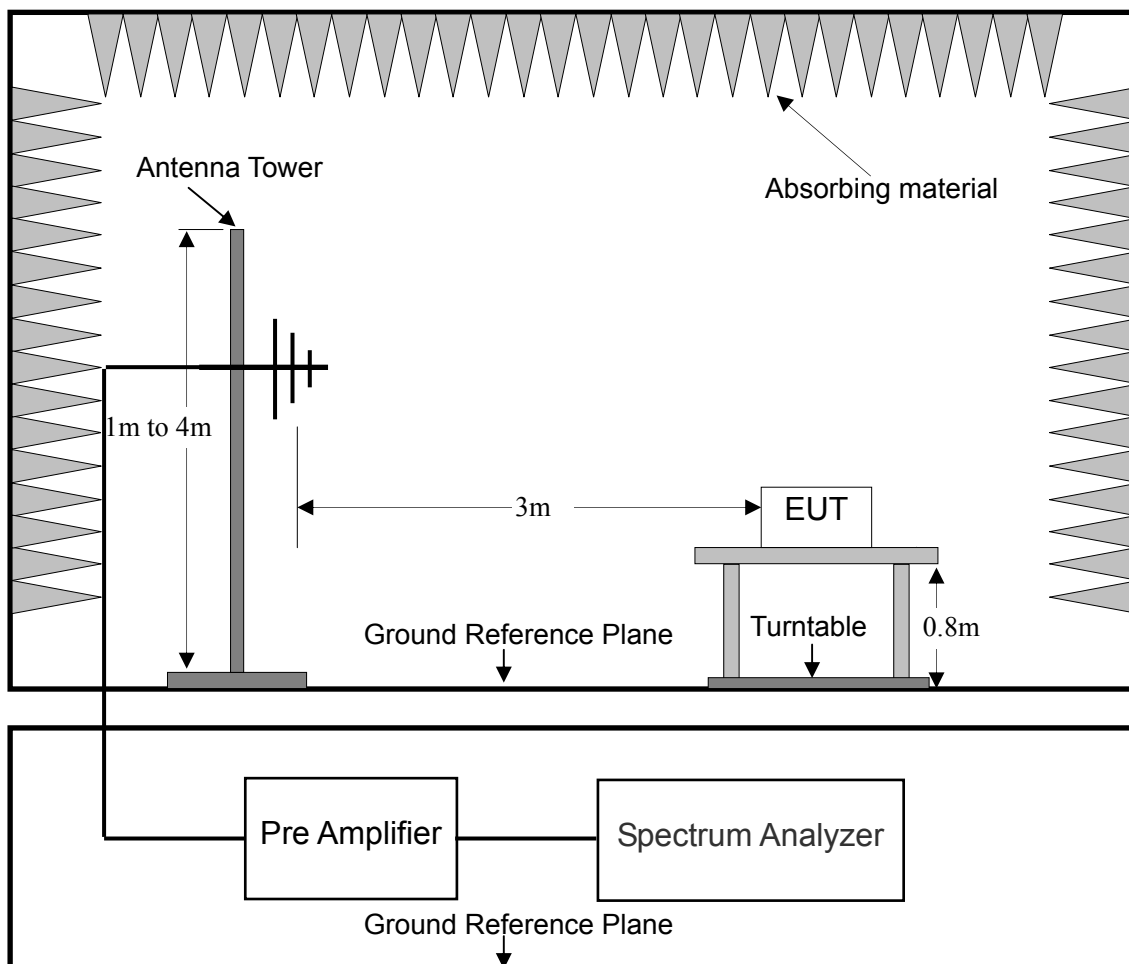

5.2 Limit of Radiated Emission Measurement

Test Standard: EN 55032

Limits for radiated disturbance at a measuring distance of 3m

Limits below 1GHz

Frequency range MHz	Quasi-peak limits dB(uV/m)
30 to 230	40
230 to 1000	47

Note 1 The lower limit shall apply at the transition frequency.

Note 2 Additional provisions may be required for cases where interference occurs.

5.3 Test Procedure

E.U.T. and its simulators are placed on a turntable, which is 0.8 meter high above ground. The turntable can rotate 360 degrees to determine the position of the maximum emission level. E.U.T. is set 3.0 meters away from the receiving antenna, which is mounted on a antenna tower. The antenna can be moved up and down between 1.0 meter and 4 meters to find out the maximum emission level. Broadband antenna (calibrated bilog antenna) is used as receiving antenna. Both horizontal and vertical polarization of the antenna is set on measurement. In order to find the maximum emission levels, all of the interface cables must be manipulated according to EN 55032 on radiated emission measurement.

The bandwidth of the EMI test is set at 120 KHz.
The frequency range from 30 MHz to 1 GHz is checked.

5.4 Operating Condition of E.U.T.

5.4.1 Setup the E.U.T. and simulators as shown in Section 2.3.

5.4.2 Turn on the power of all equipments.

5.4.3 Let the E.U.T. work in test modes (Charging+TF Card Playing, Charging+AUX IN, TF Card Playing, AUX IN) and test it.

5.5 Radiated Emission Measurement Result

PASS.

Please refer to the following pages of the worst case: Charging+TF Card Playing.



Dongguan NTC Co., Ltd.
Tel: +86-769-22022444 Fax: +86-769-22022799
Web: [Http://www.ntc-c.com](http://www.ntc-c.com)

Site: Radiation

Test Time: 2017-4-13 14:03:28

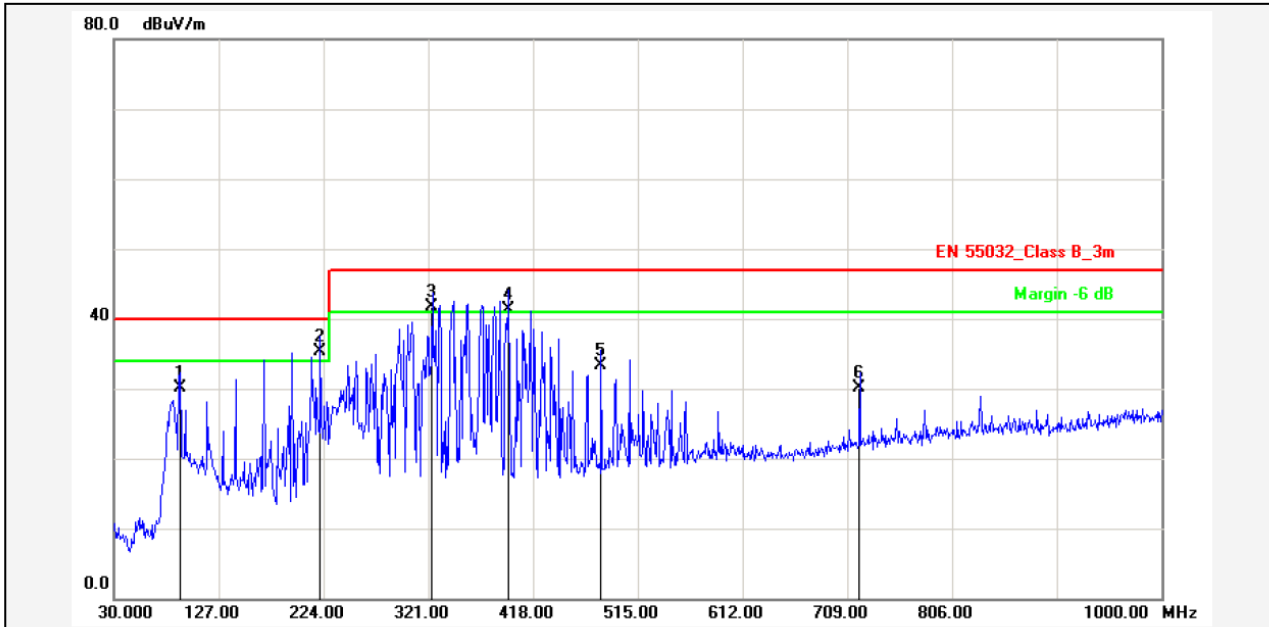

Report No.:	W6T	Test Standard:	EN 55032_Class B_3m	Test Distance:	3m
Test item:	Radiation Emission	Ant. Polarization:	Horizontal	Temp.(C)/Hum.(%):	22(C) / 54 %
Applicant:	FENDA	Power Rating:	AC 230V/50Hz	Test Engineer:	Knight
Product:	Bluetooth Speaker	Test Mode: Charging+TF Card Playing			
Model No.:	W6T	Remark:			

No.	Frequency (MHz)	Factor (dB/m)	Reading (dBuV)	Level (dBuV/m)	Limit (dBuV/m)	Margin (dB)	Detector	Height (cm)	Azimuth (deg.)	P/F	Remark
1	91.1099	-13.66	43.86	30.20	40.00	-9.80	QP			P	
2	221.0900	-12.91	48.31	35.40	40.00	-4.60	QP			P	
3	324.8798	-9.78	51.48	41.70	47.00	-5.30	QP			P	
4	395.6899	-9.13	50.53	41.40	47.00	-5.60	QP			P	
5	481.0500	-7.19	40.59	33.40	47.00	-13.60	QP			P	
6	720.6399	-3.28	33.48	30.20	47.00	-16.80	QP			P	

Note: Level=Reading+Factor.
Margin=Limit-Level.



Dongguan NTC Co., Ltd.
 Tel:+86-769-22022444 Fax:+86-769-22022799
 Web: [Http://www.ntc-c.com](http://www.ntc-c.com)

Site: Radiation

Test Time: 2017-4-13 14:10:15

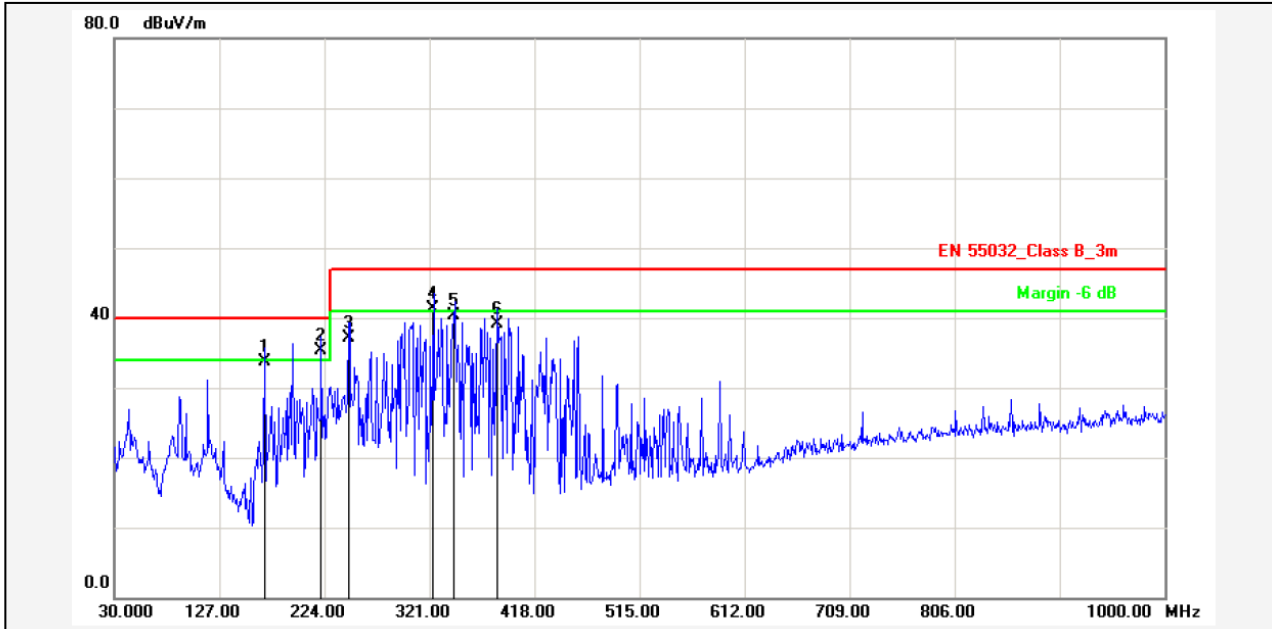

Report No.: W6T
 Test Standard: EN 55032_Class B_3m
 Test item: Radiation Emission
 Applicant: FENDA
 Product: Bluetooth Speaker
 Model No.: W6T

Test Distance: 3m
 Ant. Polarization: Vertical
 Temp.(C)/Hum.(%): 22(C) / 54 %
 Power Rating: AC 230V/50Hz
 Test Engineer: Knight

Test Mode: Charging+TF Card Playing
 Remark:

No.	Frequency (MHz)	Factor (dB/m)	Reading (dBuV)	Level (dBuV/m)	Limit (dBuV/m)	Margin (dB)	Detector	Height (cm)	Azimuth (deg.)	P/F	Remark
1	168.7100	-17.85	51.55	33.70	40.00	-6.30	QP			P	
2	221.0900	-15.91	51.21	35.30	40.00	-4.70	QP			P	
3	246.3100	-14.19	51.39	37.20	47.00	-9.80	QP			P	
4	324.8798	-11.78	53.18	41.40	47.00	-5.60	QP			P	
5	344.2798	-11.21	51.51	40.30	47.00	-6.70	QP			P	
6	384.0500	-11.19	50.39	39.20	47.00	-7.80	QP			P	

Note: Level=Reading+Factor.
 Margin=Limit-Level.

6. PERFORMANCE CRITERIA FOR IMMUNITY

The performance criteria are referred to the test standard: EN 55020

Performance Criteria A

The equipment shall continue to operate as intended during the test. No change of actual operating state (for example change of channel) is allowed as a result of the application of the test. Multifunction equipment shall for each function meet the relevant requirements. Evaluation is carried out for audio and video functions.

Evaluation of Audio Quality

The criterion of compliance with the requirement is a wanted to unwanted audio signal ratio of ≥ 40 dB at a wanted audio signal level of 50mW, or at another audio signal level specified by the manufacturer. If the S/N ratio is less than 43dB, the performance criterion for audio assessment is the actual S/N ratio minus 3dB. For AM sound receivers the criterion is ≥ 26 dB at 50mW; and is ≥ 26 dB at 500mW for the AM/FM car radios or broadcast receiver cards for computers.

Evaluation of Video Quality

In the evaluation of picture interference the wanted test signal produces a standard picture (in the case of video tape equipment on the screen of the test-tv-set) and the unwanted signal produces a degradation of the picture. The degradation may be in a number of forms, such as a superposed pattern, disturbance of synchronization, geometrical distortion, loss of picture contrast, of colour, etc.

The criterion of compliance with the requirement is just perceptible degradation by observation of the picture. The screen shall be observed under normal viewing conditions (brightness 15 lx to 20 lx), at a viewing distance of six times the height of the screen.

Performance criterion B

The equipment shall continue to operate as intended after the test. No loss of function is allowed after the test when the apparatus is used as intended, but failures which are recovered automatically but which cause temporary delay in processing, are permissible. No change of actual operating state for example change of channel or stored data and settings is allowed as a result of the application of the test. During the test, degradation of performance is allowed.

7. ELECTROSTATIC DISCHARGE IMMUNITY TEST

7.1 Block Diagram of Test Setup

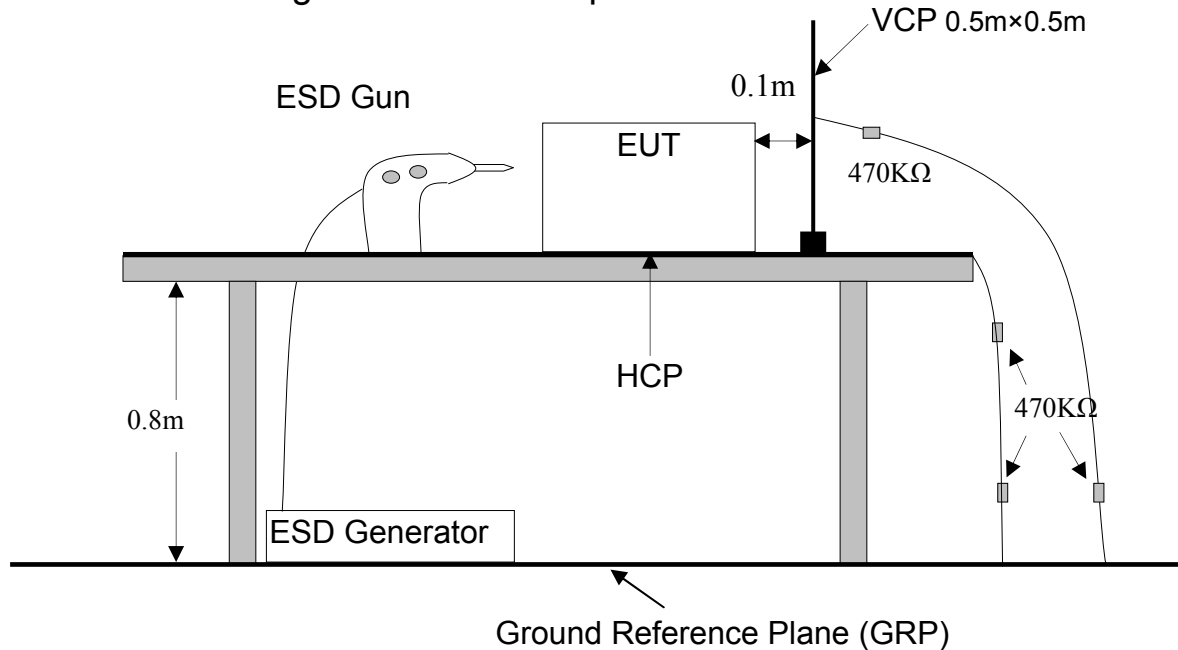

7.2 Test Standard and Severity Levels

7.2.1 Test Standard:

EN 55020

(EN 61000-4-2 Air Discharge: Severity Level: 3, ± 8 KV;

Contact Discharge: Level: 2, ± 4 KV)

7.2.2 Severity Levels:

Level	Test Voltage Contact Discharge (KV)	Test Voltage Air Discharge (KV)
1.	± 2	± 2
2.	± 4	± 4
3.	± 6	± 8
4.	± 8	± 15
X	Special	Special

7.3 Test Procedure

7.3.1 Air Discharge:

This test is done on a non-conductive surface. The round discharge tip of the discharge electrode shall be approached as fast as possible to touch the E.U.T.. After each discharge, the discharge electrode shall be removed from the E.U.T..

The generator is then re-triggered for a new single discharge and repeated 10 times for each pre-selected test point. This procedure shall be repeated until all the air discharge completed.

7.3.2 Contact Discharge:

All the procedure shall be same as Section 7.3.1. except that the tip of the discharge electrode shall touch the E.U.T..

7.3.3 Indirect discharge for horizontal coupling plane

At least 10 single discharges (in the most sensitive polarity) shall be applied at the front edge of each HCP opposite the center point of each unit(if applicable) of the E.U.T. and 0.1m from the front of the E.U.T.. The long axis of the discharge electrode shall be in the plane of the HCP and perpendicular to its front edge during the discharge.

7.3.4 Indirect discharge for vertical coupling plane

At least 10 single discharges (in the most sensitive polarity) shall be applied to the center of one vertical edge of the coupling plane. The coupling plane, of dimensions 0.5m X 0.5m, is placed parallel to, and positioned at a distance of 0.1m from the E.U.T.. Discharges shall be applied to the coupling plane, with this plane in sufficient different positions that the four faces of the E.U.T. are completely illuminated.

7.4 Test Results

PASS.

Please refer to the following page.

Electrostatic Discharge Test Results

Ambient Condition:	Temp.: 22 °C	R.H.: 57%	Air Pressure : 101 kPa
Power Supply:	AC 230V(Adapter input) DC 3.7V	Required Performance Criterion : B	
Test Level:	±2, 4 KV Contact Discharge; ±2, 4, 8 KV Air Discharge For each point positive 10 times and negative 10 times		
Tested mode:	TF Card Playing, Charging+AUX IN, Charging+TF Card Playing, AUX IN		
Test Point	Kind A-Air Discharge C-Contact Discharge	Result (Performance Criterion)	
TF Card port	A	A	
Slot of EUT	A	A	
DC Port	C	A	
AUX Port	A	A	
Metal	C	A	
Indirect Discharge (HCP)	C	A	
Indirect Discharge (VCP)	C	A	
<p>Note: The EUT stop working during the test, but it can be resumed to normal operation by user after test. After consider with client's confirmation that relevant instruction will be mentioned in the manual, so the test result was considered to be passed.</p>			
Test Equipment : ESD Tester (TESEQ, NSG 437)		Test Engineer : Chilam	

8. RF VOLTAGES IMMUNITY TEST(S2)

8.1 Test setup

Antenna terminals:

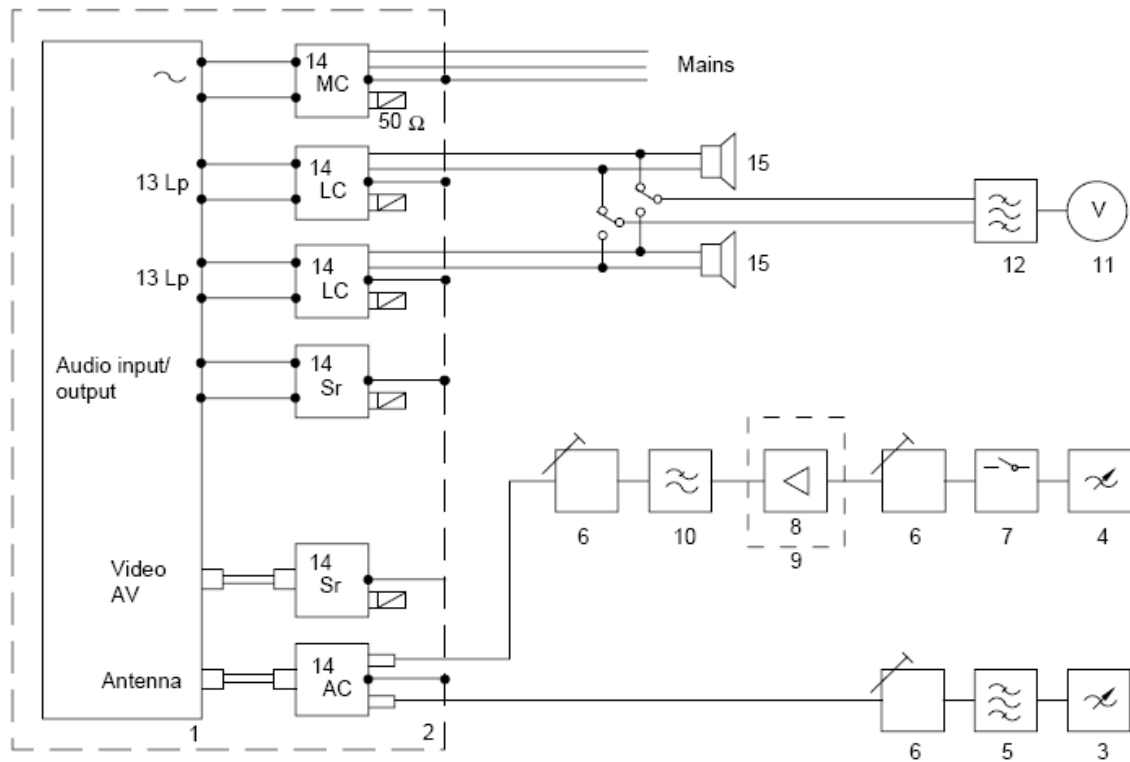

IEC 451/02

Key

- | | |
|-----------------------------------|---|
| 1 Equipment under test | 9 Shielded box Sh |
| 2 Metal plate P = 2 m × 1 m | 10 Low-pass filter F |
| 3 Generator of wanted signal G1 | 11 Audio frequency voltmeter V |
| 4 Generator of unwanted signal G2 | 12 Band-pass filter 0,5 kHz to 3 kHz (see annex B) |
| 5 Channel filter Fc | 13 Loudspeaker connectors Lp |
| 6 Attenuators T1, T2, T3 | 14 Coupling units MC, LC, Sr, AC (see annex C) |
| 7 Switch S1 | of the loudspeaker |
| 8 Amplifier Am | 15 Dummy load simulating the nominal impedance of the loudspeaker |

Other terminals:

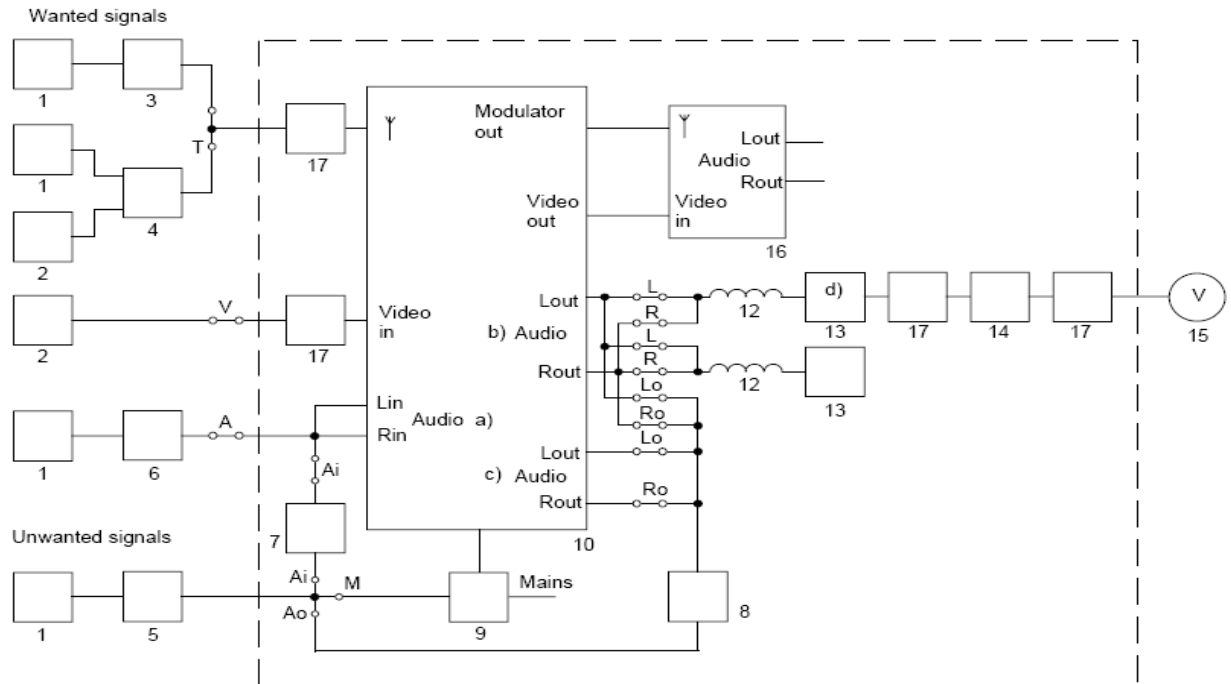

IEC 452/02

- a) Channels 1 and 2 in the case of two channel sound television equipment.
- b) Audio power output provided for adjusting and measurement.
- c) Other audio outputs.
- d) To be left out in case of high-resistance (>10 kΩ) audio output impedance.

Key

- | | |
|---------------------------------------|---|
| 1 AF generator 1 kHz G1 | 10 Equipment under test |
| 2 Video generator G2 | 11 Metal plate $P = 2 \text{ m} \times 1 \text{ m}$ |
| 3 RF generator G3 for FM | 12 RF choke $L = 100 \mu\text{H}$ |
| 4 RF generator G4 for TV | 13 Rated load impedance of the audio output R_L |
| 5 RF generator G5 for unwanted signal | 14 Band-pass filter BP (input impedance 10 kΩ) |
| 6 Impedance (R_s to R_{G1}) | 15 Audio frequency voltmeter V |
| 7 RC network for audio inputs RC_i | 16 Test-TV-set TTS |
| 8 RC network for audio outputs RC_o | 17 Sheath current choke Sh (ferrite cores) |
| 9 Mains stop filter MSF | |

(12, 13, 14 and 15 may be replaced by figure 2b or 2c if appropriate.)
 R_s rated source impedance of the audio input (1 kΩ in the case of video tape equipment).

8.2 Test Standard and Limits

8.2.1 Test Standard

EN 55020

8.2.2 Limits

Table 1 Limits of immunity of RF voltages of mains, loudspeaker and headphone terminals

Frequency MHz	Level dB(μ V)(e.m.f.)
0.15 to 30	130
30 to 100	120
100 to 150	120-110 ^a
^a Decreasing linearly with the logarithm of frequency	

Table 2 Limits of immunity to RF voltages of audio input and output terminals (except loudspeaker and headphone terminals)(S2)

Frequency MHz	Level dB(μ V)(e.m.f.)
0.15 to 1.6	80-90 ^a
1.6 to 20	90-120 ^a
20 to 100	120
100 to 150	120-110 ^b
^a Increasing linearly with the logarithm of frequency	
^b Decreasing linearly with the logarithm of frequency	

8.3 Test Result

PASS.

Please refer to the following page of the worst case.

Test: Immunity Conducted Voltages S2a <W6T>

Test Mode: Combi Device -
Operating Mode: AUX
Frequency: -

Monitor: Audio Out
S/N: 69.5 dB
AF Level: 446.0 mV

Interf. Signal: AUX, 100317-00878-001, 3/10/2017, 3:01:33PM

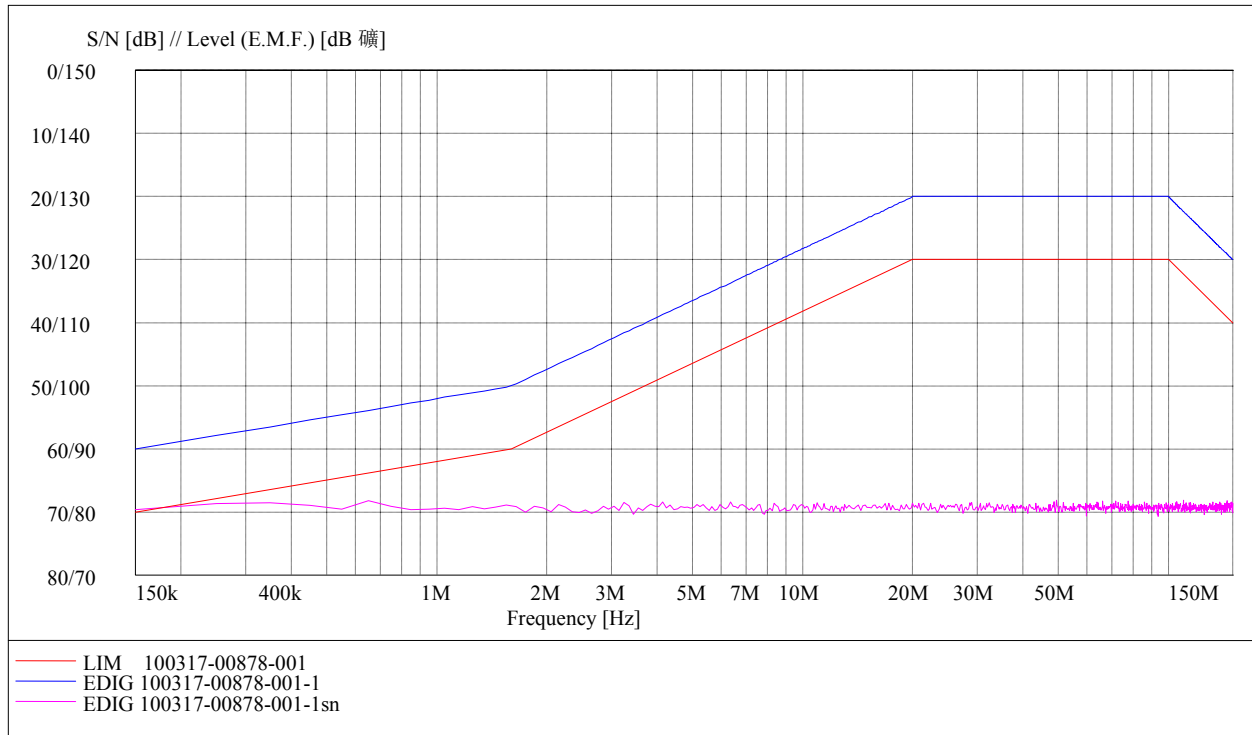

9. PHOTOGRAPHS

9.1 Photo of Power Line Conducted Emission Measurement



9.2 Photo of Radiated Emission Measurement

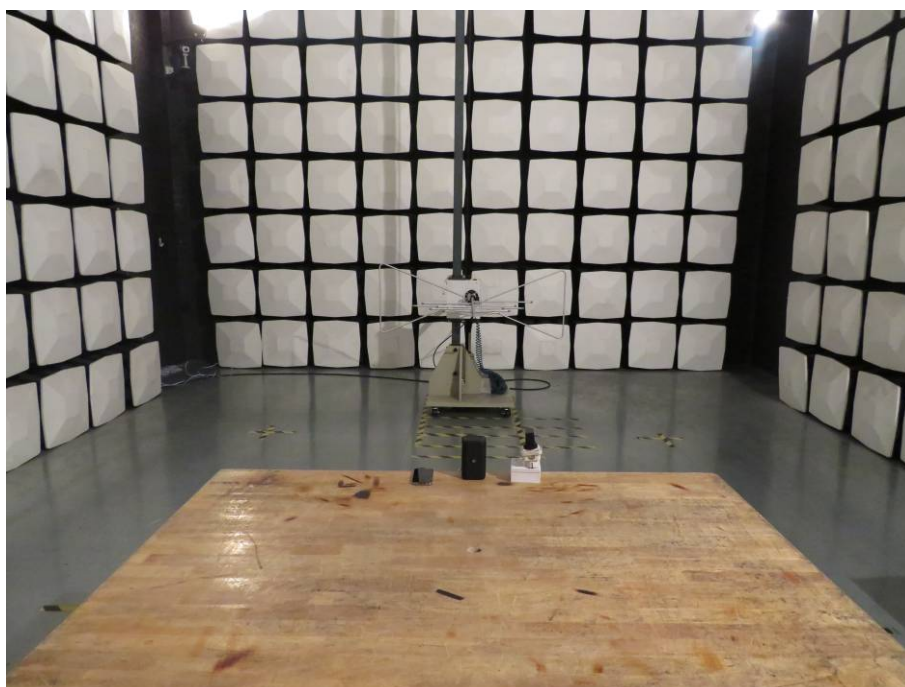

9.3 Photo of Electrostatic Discharge Immunity Measurement



9.4 Photo of S2 Measurement



APPENDIX I (PHOTOS OF E.U.T.)

Figure 1
General Appearance of the E.U.T.



Figure 2
General Appearance of the E.U.T.



Figure 3
General Appearance of the E.U.T.



Figure 4
General Appearance of the E.U.T.



Figure 5
General Appearance of the E.U.T.



Figure 6
General Appearance of the E.U.T.



Figure 7
General Appearance of the E.U.T.



Figure 8
General Internal of the E.U.T.

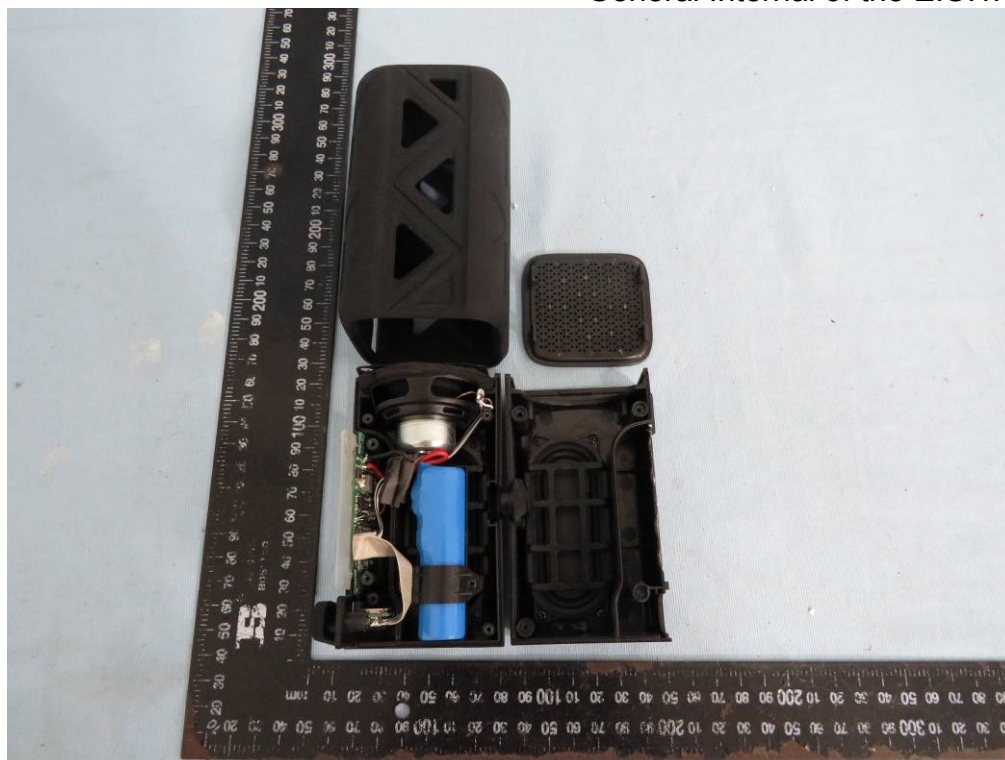

Figure 9
General Appearance of the PCB

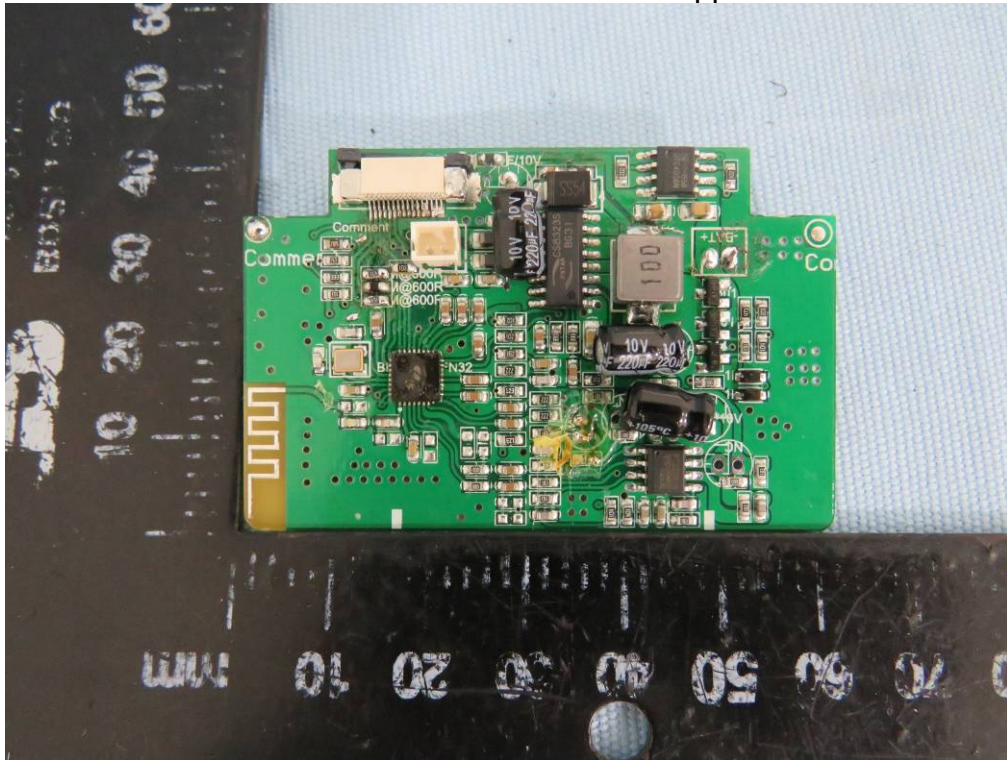

Figure 10
General Appearance of the PCB

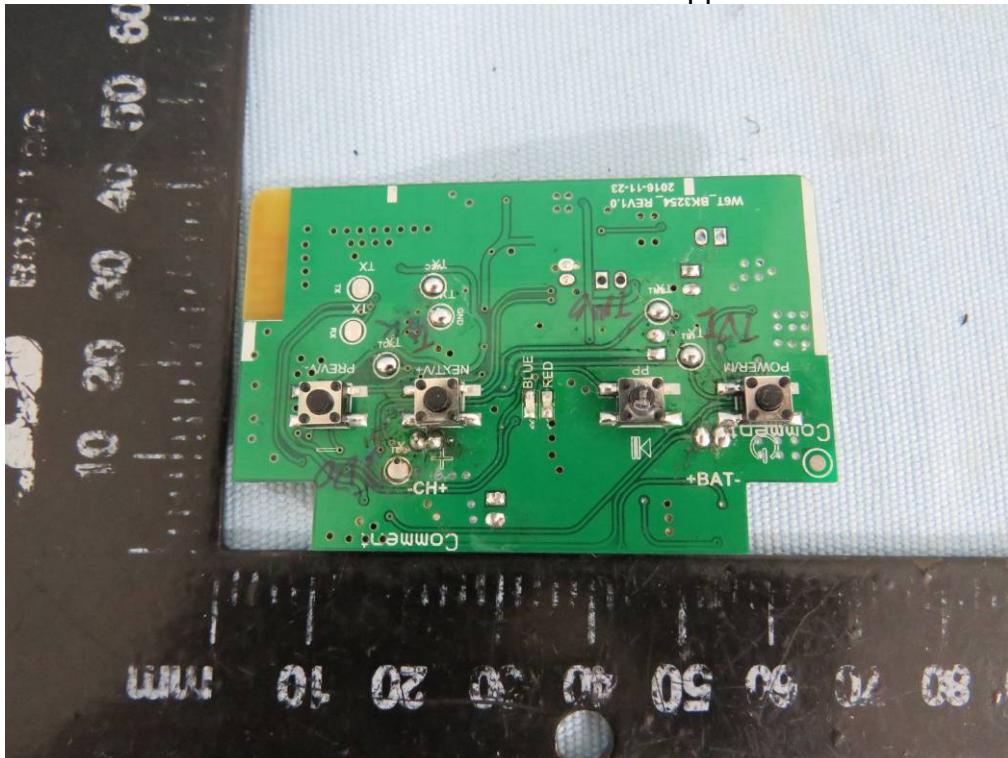

Figure 11
General Appearance of the PCB

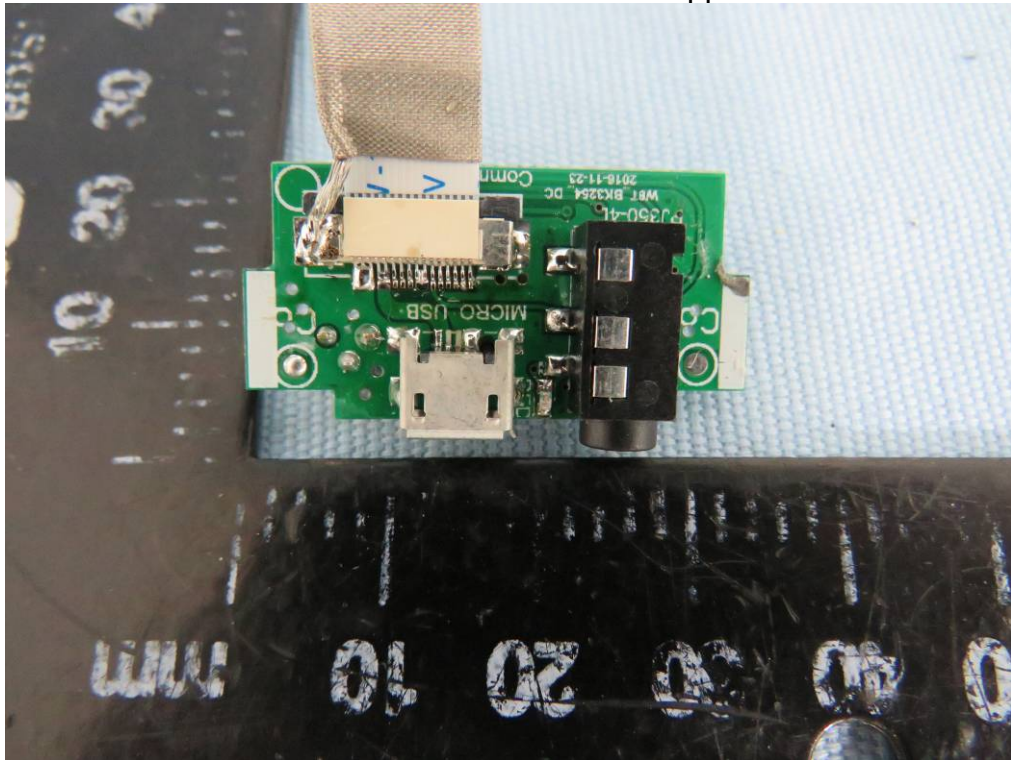

Figure 12
General Appearance of the PCB

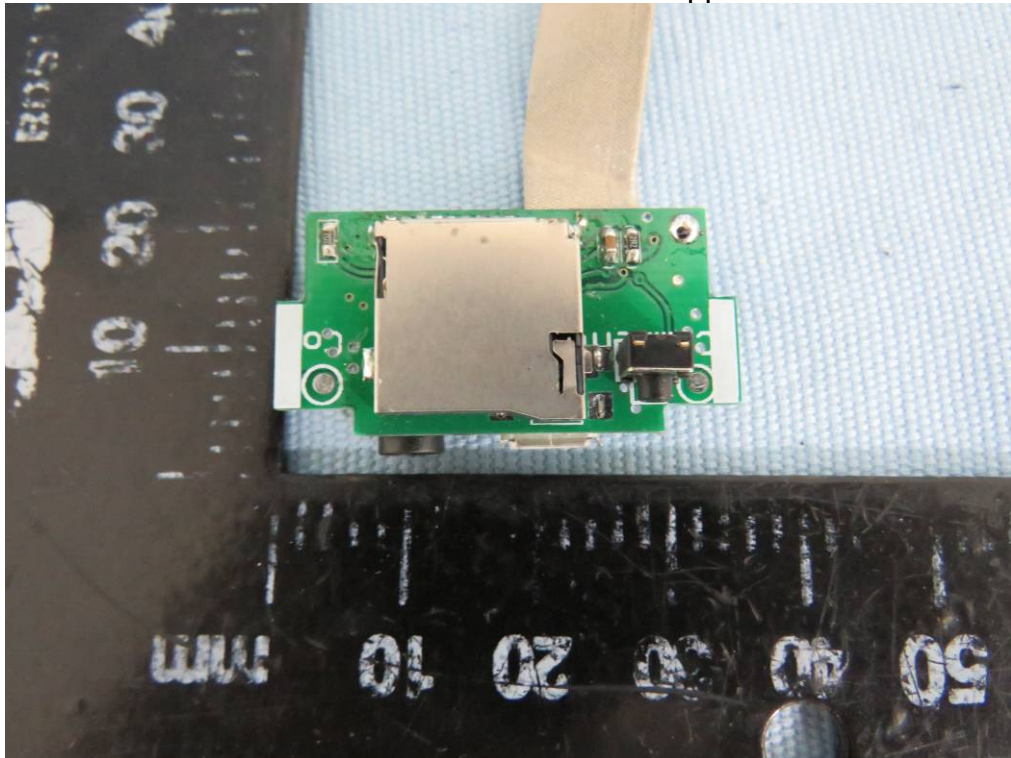

Figure 13
General Appearance of the PCB

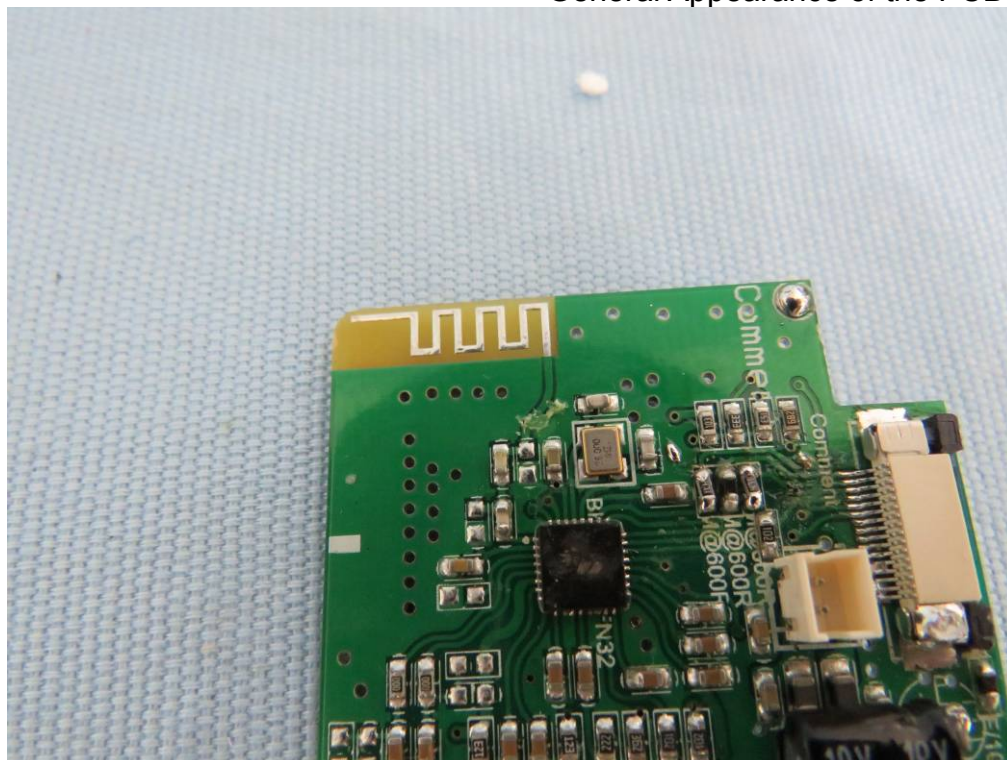

Figure 14
General Appearance of the battery

