

EMC Test Report

Project No. : 1712C140
Equipment : Gaming Mouse Mat
Test Model : RZ02-0250
Series Model : RZ02-0250XXXX-XXXX (X: Can be 0-9, A-Z)
Applicant : Razer Inc.
Address : 201 3rd Street, Suite 900, San Francisco, CA 94103, USA

Date of Receipt : Dec. 14, 2017
Date of Test : Dec. 14, 2017 ~ Dec. 22, 2017
Issued Date : Dec. 25, 2017
Tested by : BTL Inc.

Testing Engineer : Helen Wang
(Helen Wang)

Technical Manager : Bill Zhang
(Bill Zhang)

Authorized Signatory : Tony Li
(Tony Li)

B T L I N C .

No.3, Jinshagang 1st Road, Shixia, Dalang Town, Dongguan, Guangdong, China.

TEL: +86-769-8318-3000 FAX: +86-769-8319-6000



Declaration

BTL represents to the client that testing is done in accordance with standard procedures as applicable and that test instruments used has been calibrated with standards traceable to international standard(s) and/or national standard(s).

BTL's reports apply only to the specific samples tested under conditions. It is manufacture's responsibility to ensure that additional production units of this model are manufactured with the identical electrical and mechanical components. **BTL** shall have no liability for any declarations, inferences or generalizations drawn by the client or others from **BTL** issued reports.

BTL's report must not be used by the client to claim product certification, approval, or endorsement by NVLAP, NIST, or any agency of the Federal Government.

This report is the confidential property of the client. As a mutual protection to the clients, the public and **BTL-self**, extracts from the test report shall not be reproduced except in full with **BTL's** authorized written approval.

BTL's laboratory quality assurance procedures are in compliance with the **ISO Guide 17025** requirements, and accredited by the conformity assessment authorities listed in this test report.

Limitation

For the use of the authority's logo is limited unless the Test Standard(s)/Scope(s)/Item(s) mentioned in this test report is (are) included in the conformity assessment authorities acceptance respective.

Table of Contents

Page

REPORT ISSUED HISTORY	6
1 . CERTIFICATION	7
2 . SUMMARY OF TEST RESULTS	8
2.1 TEST FACILITY	10
2.2 MEASUREMENT UNCERTAINTY	10
3 . GENERAL INFORMATION	11
3.1 GENERAL DESCRIPTION OF EUT	11
3.2 DESCRIPTION OF TEST MODES	11
3.3 EUT OPERATING CONDITIONS	12
3.4 BLOCK DIAGRAM SHOWING THE CONFIGURATION OF SYSTEM TESTED	12
3.5 DESCRIPTION OF SUPPORT UNITS	12
4 . EMC EMISSION TEST	13
4.1 RADIATED EMISSION	13
4.1.1 LIMITS	13
4.1.2 MEASUREMENT INSTRUMENTS LIST	14
4.1.3 TEST PROCEDURE	15
4.1.4 DEVIATION FROM TEST STANDARD	15
4.1.5 TEST SETUP	15
4.1.6 MEASUREMENT DISTANCE	16
4.1.7 TEST RESULTS (UP TO 1 GHZ)	17
4.2 CONDUCTED EMISSION MEASUREMENT AT AC MAINS POWER PORTS	19
4.2.1 LIMITS	19
4.2.2 MEASUREMENT INSTRUMENTS LIST	19
4.2.3 TEST PROCEDURE	20
4.2.4 DEVIATION FROM TEST STANDARD	20
4.2.5 TEST SETUP	20
4.2.6 TEST RESULTS	21
5 . EMC IMMUNITY TEST	23
5.1 STANDARD COMPLIANCE/SEVERITY LEVEL/CRITERIA	23
5.2 GENERAL PERFORMANCE CRITERIA	25
5.3 ELECTROSTATIC DISCHARGE IMMUNITY TEST (ESD)	26
5.3.1 TEST SPECIFICATION	26
5.3.2 MEASUREMENT INSTRUMENTS	26
5.3.3 TEST PROCEDURE	26
5.3.4 DEVIATION FROM TEST STANDARD	27
5.3.5 TEST SETUP	27
5.3.6 TEST RESULTS	28

Table of Contents

Page

5.4 RADIATED, RADIO-FREQUENCY, ELECTROMAGNETIC FIELD IMMUNITY TEST (RS)	30
5.4.1 TEST SPECIFICATION	30
5.4.2 MEASUREMENT INSTRUMENTS	30
5.4.3 TEST PROCEDURE	30
5.4.4 DEVIATION FROM TEST STANDARD	30
5.4.5 TEST SETUP	31
5.4.6 TEST RESULTS	32
5.5 ELECTRICAL FAST TRANSIENT/BURST IMMUNITY TEST (EFT/BURST)	33
5.5.1 TEST SPECIFICATION	33
5.5.2 MEASUREMENT INSTRUMENTS	33
5.5.3 TEST PROCEDURE	33
5.5.4 DEVIATION FROM TEST STANDARD	33
5.5.5 TEST SETUP	34
5.5.6 TEST RESULTS	35
5.6 SURGE IMMUNITY TEST	36
5.6.1 TEST SPECIFICATION	36
5.6.2 MEASUREMENT INSTRUMENTS	36
5.6.3 TEST PROCEDURE	37
5.6.4 DEVIATION FROM TEST STANDARD	37
5.6.5 TEST SETUP	37
5.6.6 TEST RESULTS	38
5.7 IMMUNITY TO CONDUCTED DISTURBANCES, INDUCED BY RADIO-FREQUENCY FIELDS TEST (CS)	39
5.7.1 TEST SPECIFICATION	39
5.7.2 MEASUREMENT INSTRUMENTS	39
5.7.3 TEST PROCEDURE	39
5.7.4 DEVIATION FROM TEST STANDARD	39
5.7.5 TEST SETUP	40
5.7.6 TEST RESULTS	41
5.8 POWER FREQUENCY MAGNETIC FIELD IMMUNITY TEST (PFMF)	42
5.8.1 TEST SPECIFICATION	42
5.8.2 MEASUREMENT INSTRUMENTS	42
5.8.3 TEST PROCEDURE	42
5.8.4 DEVIATION FROM TEST STANDARD	42
5.8.5 TEST SETUP	43
5.8.6 TEST RESULTS	44
5.9 VOLTAGE DIPS, SHORT INTERRUPTIONS AND VOLTAGE VARIATIONS IMMUNITY TEST	45
5.9.1 TEST SPECIFICATION	45
5.9.2 MEASUREMENT INSTRUMENTS	45
5.9.3 TEST PROCEDURE	45

Table of Contents

Page

5.9.4 DEVIATION FROM TEST STANDARD	45
5.9.5 TEST SETUP	46
5.9.6 TEST RESULTS	47
6 . EUT TEST PHOTO	48

REPORT ISSUED HISTORY

Issued No.	Description	Issued Date
BTL-EMC-1-1712C140	Original Issue.	Dec. 25, 2017

1. CERTIFICATION

Equipment : Gaming Mouse Mat
Brand Name : RAZER
Test Model : RZ02-0250
Series Model : RZ02-0250XXXX-XXXX (X: Can be 0-9, A-Z)
Applicant : Razer Inc.
Manufacturer : Razer (Asia-Pacific) Pte.,Ltd.
Address : 514 Chai Chee Lane #07-01 ~ 06 Singapore 469029, Tel: +65 6505 2188
Factory : RAZER TECHNOLOGY AND DEVELOPMENT (SHENZHEN) CO., LTD
Address : East Wing, 3rd Floor, Block 2, Phase 1 of Vision Shenzhen Business Park Keji South Road, Hi-Tech Industrial Park, Shenzhen 518057, China
Date of Test : Dec. 14, 2017 ~ Dec. 22, 2017
Test Sample : Engineering Sample
Standard(s) : EN 55032: 2015 Class B
EN 55024: 2010+A1:2015
EN 61000-4-2: 2009
EN 61000-4-3: 2006+A1:2008+A2:2010
EN 61000-4-4: 2012
EN 61000-4-5: 2014
EN 61000-4-6: 2014+AC:2015
EN 61000-4-8: 2010
EN 61000-4-11: 2004

The above equipment has been tested and found compliance with the requirement of the relative standards by BTL Inc.
The test data, data evaluation, and equipment configuration contained in our test report (Ref No. BTL-EMC-1-1712C140) were obtained utilizing the test procedures, test instruments, test sites that has been accredited by the Authority of TAF according to the ISO-17025 quality assessment standard and technical standard(s).

2. SUMMARY OF TEST RESULTS

Test procedures according to the technical standards:

Emission					
Standard(s)	Test Item	Limit	Judgment	Remark	
EN 55032: 2015	Radiated emissions up to 1 GHz	Class B	PASS		
	Radiated emissions above 1 GHz	Class B	N/A	NOTE (1) NOTE (2)	
	Radiated emissions from FM receivers	-----	N/A	NOTE (1) NOTE (6)	
	Conducted emissions AC mains power port	Class B	PASS	NOTE (7)	
	Asymmetric mode conducted emissions	AAN	-----	N/A	NOTE (1) NOTE (8)
		Current Probe	-----	N/A	
		CVP	-----	N/A	
Conducted differential voltage emissions	-----	N/A	NOTE (1) NOTE (9)		

Immunity EN 55024: 2010+A1:2015				
Section(s)	Test Item	Performance Criterion	Judgment	Remark
EN 61000-4-2:2009	Electrostatic discharge immunity	B	PASS	
EN 61000-4-3: 2006+A1:2008+A2:2010	Radiated, radio-frequency, electromagnetic field immunity	A	PASS	
EN 61000-4-4:2012	Electrical fast transient/burst immunity	B	PASS	
EN 61000-4-5:2014	Surge immunity	B/C	PASS	NOTE (4)
EN 61000-4-6: 2014+AC :2015	Immunity to conducted disturbances, induced by radio-frequency fields	A	PASS	
EN 61000-4-8:2010	Power frequency magnetic field immunity	A	PASS	
EN 61000-4-11:2004	Voltage dips, short interruptions and voltage variations immunity	B / C / C	PASS	NOTE (5)

NOTE:

- (1) "N/A" denotes test is not applicable to this device.
- (2) The EUT's max operating frequency is 12 MHz which does not exceed 108 MHz, so the test will not be performed.
- (3) If the power consumption is less than 75W, there is no limit applied.
- (4) Performance Criterion C for signal ports and telecommunication ports.
Performance Criterion B for input d.c. power port and a.c. power ports.
- (5) Voltage Dips: >95% reduction – Performance Criterion B
Voltage Dips: 30% reduction – Performance Criterion C
Voltage Interruptions: >95% reduction – Performance Criterion C
- (6) If the EUT has FM function the test will be performed.
- (7) If the EUT has AC power mains port the test will be performed.
- (8)

Cable Type	Number of pairs	Measurement type	Procedures
Balanced Unscreened	1 (2 wire) ;2 (4 wire); 3 (6 wire) ;4 (8 wire)	Voltage	AAN
Balanced Unscreened	See a)	Voltage and Current	CP+CVP
Screened or Coaxial	n/a	Voltage	AAN
Screened or Coaxial	n/a	Voltage or Current	CP or CVP
Unbalanced cables	n/a	Voltage and Current	CP+CVP

Ports connected to cables with more than 4 balanced pairs or where the port is unable to function correctly when connected through an AAN.

- (9) If the EUT has tuner port the test will be performed.
- (10) The requirement followed by the client's specification.

2.1 TEST FACILITY

The test facilities used to collect the test data in this report is at the location of No.3, Jinshagang 1st Road, Shixia, Dalang Town, Dongguan, Guangdong, China.

2.2 MEASUREMENT UNCERTAINTY

Where relevant, the following measurement uncertainty levels have been estimated for tests performed on the EUT as specified in CISPR 16-4-2, The BTL measurement uncertainty is less than the CISPR 16-4-2 U_{cispr} requirement.

The reported uncertainty of measurement $y \pm U$, where expanded uncertainty U is based on a standard uncertainty multiplied by a coverage factor of $k=2$, providing a level of confidence of approximately **95%**.

A. Radiated emissions up to 1 GHz measurement:

Test Site	Method	Measurement Frequency Range	Ant. H / V	U, (dB)
DG-CB08 (10m)	CISPR	30MHz ~ 200MHz	V	4.66
		30MHz ~ 200MHz	H	4.64
		200MHz ~ 1,000MHz	V	4.88
		200MHz ~ 1,000MHz	H	4.86

B. Conducted emissions AC mains power port measurement:

Test Site	Method	Measurement Frequency Range	U, (dB)
DG-C02	CISPR	150 kHz ~ 30MHz	2.32

C. Immunity Measurement:

Test Site	Method	Measurement Frequency Range	U, (dB)
DG-SR02	EN 61000-4-2	Rise time t_r	14.6 %
		Peak current I_p	7.70 %
		Current at 30 ns	7.72 %
		Current at 60 ns	7.72 %
DG-CB05	EN 61000-4-3	80MHz~1GHz	2.175 dB
		Electrical measurements	2.267 dB
		Measuring the demodulation on analogue wired network lines	2.267 dB
DG-SR05	EN 61000-4-4	Voltage rise time (t_r)	10.4 %
		Voltage peak value(V_P)	8.2 %
		Voltage pulse width(t_w)	6.0 %
DG-SR05	EN 61000-4-5	Voltage front time (T_{fv})	5.8 %
		Voltage peak value(V_P)	3.9 %
		Voltage duration(t_d)	0.6 %
DG-CB06	EN 61000-4-6	CDN	3.25 dB
		EM Clamp	4.410 dB
		Electrical measurements	3.258 dB
		measuring the demodulation on analogue wired network lines	3.258 dB
DG-SR05	EN 61000-4-8	Magnetic Field Level	3.787 %
DG-SR05	EN 61000-4-11	voltage fall time (T_f)	2 %

Note: Unless specifically mentioned, the uncertainty of measurement has not been taken into account to declare the compliance or non-compliance to the specification.

3. GENERAL INFORMATION

3.1 GENERAL DESCRIPTION OF EUT

Equipment	Gaming Mouse Mat
Brand Name	RAZER
Test Model	RZ02-0250
Series Model	RZ02-0250XXXX-XXXX (X: Can be 0-9, A-Z)
Model Difference	It is the same as the basic model and X is used to define which country it is for under the same family series.
Power Source	Supplied from USB port.
Power Rating	DC5V 180mA

Note:

1. For a more detailed features description, please refer to the manufacturer's specifications or the user's manual.

3.2 DESCRIPTION OF TEST MODES

To investigate the maximum EMI emission characteristics generates from EUT, the test system was pre-scanning tested base on the consideration of following EUT operation mode or test configuration mode which possible have effect on EMI emission level. Each of these EUT operation mode(s) or test configuration mode(s) mentioned above was evaluated respectively.

Pretest Mode	Description
Mode 1	Operating

For Radiated Test	
Final Test Mode	Description
Mode 1	Operating

For Conducted Test	
Final Test Mode	Description
Mode 1	Operating

For EMS Test	
Final Test Mode	Description
Mode 1	Operating

3.3 EUT OPERATING CONDITIONS

The EUT exercise program used during radiated and/or conducted emission measurement was designed to exercise the various system components in a manner similar to a typical use. The standard test signals and output signal as following:

1. EUT connected to PC via USB cable.
2. PC connected to keyboard via USB cable.
3. PC connected to monitor via D-SUB cable.
4. The mouse is putted on the EUT.

3.4 BLOCK DIAGRAM SHOWING THE CONFIGURATION OF SYSTEM TESTED

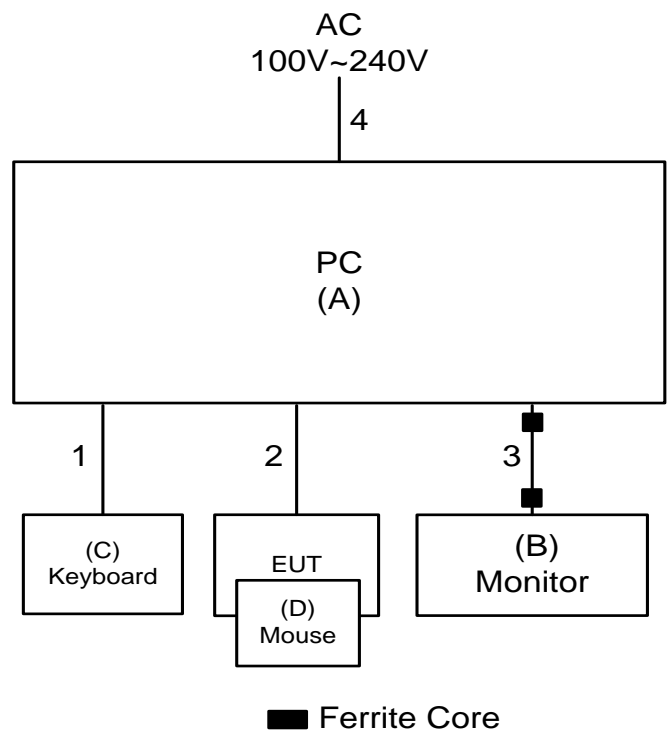

3.5 DESCRIPTION OF SUPPORT UNITS

The EUT has been tested as an independent unit together with other necessary accessories or support units. The following support units or accessories were used to form a representative test configuration during the tests.

Item	Equipment	Mfr/Brand	Model/Type No.	FCC ID	Series No.
A	PC	DELL	9010 MT	DOC	HOTQ2W1
B	Monitor	DELL	E117FPC	N/A	CN-OFJ179-64180-6AG-IWNS
C	Keyboard	DELL	L100	DOC	CNORH6596589071T08NE
D	Mouse	DELL	MS111-P	DOC	CN011D3V71581279OLOT

Item	Shielded Type	Ferrite Core	Length	Note
1	YES	NO	1.8m	USB Cable
2	YES	NO	1.8m	USB Cable
3	YES	YES	1.8m	D-SUB Cable
4	YES	NO	1.8m	AC Cable

4. EMC EMISSION TEST

4.1 RADIATED EMISSION

4.1.1 LIMITS

Class A equipment up to 1000MHz

Table clause	Frequency range MHz	Measurement			Class A limits dB(μV/m)
		Facility (see Table A.1)	Distance m	Detector type/ bandwidth	
A2.1	30-230	OATS/SAC	10	Quasi peak / 120 kHz	40
	230-1000				47
A2.2	30-230	OATS/SAC	3		50
	230-1000				57
A2.3	30-230	FAR	10	Quasi peak / 120 kHz	42 to 35
	230-1000				42
A2.4	30-230	FAR	3		52 to 45
	230-1000				52

Apply only A2.1 or A2.2 or A2.3 or A2.4 across the entire frequency range.

Class B equipment up to 1000MHz

Table clause	Frequency range MHz	Measurement			Class B limits dB(μV/m)
		Facility (see Table A.1)	Distance m	Detector type/ bandwidth	
A4.1	30-230	OATS/SAC	10	Quasi peak / 120 kHz	30
	230-1000				37
A4.2	30-230	OATS/SAC	3		40
	230-1000				47
A4.3	30-230	FAR	10	Quasi peak / 120 kHz	32 to 25
	230-1000				32
A4.4	30-230	FAR	3		42 to 35
	230-1000				42

Apply only table clause A4.1 or A4.2 or A4.3 or A4.4 across the entire frequency range.

These requirements are not applicable to the local oscillator and harmonics frequencies of equipment covered by Table A.6.

Notes:

- (1) The limit for radiated test was performed according to as following: EN 55032
- (2) The tighter limit applies at the band edges.
- (3) Emission level (dBuV/m)=20log Emission level (uV/m).
- (4) The test result calculated as following:
 Measurement Value = Reading Level + Correct Factor
 Correct Factor = Antenna Factor + Cable Loss - Amplifier Gain(if use)
 Margin Level = Measurement Value - Limit Value

Required highest frequency for radiated measurement

Highest internal frequency (F_x) MHz	Highest measured frequency MHz
$F_x \leq 108$	1000
$108 < F_x \leq 500$	2000
$500 < F_x \leq 1000$	5000
$F_x > 1000$	5 th up to a maximum 6 GHz,

Note for FM and TV broadcast receiver, F_x is determined from the highest frequency generated or used excluding the local oscillator and tuned frequencies.

4.1.2 MEASUREMENT INSTRUMENTS LIST

Up to 1GHz:

Item	Kind of Equipment	Manufacturer	Type No.	Serial No.	Calibrated until
1	Pre-Amplifier	Mini-Circuits	EMC 9135	980284	Mar. 26, 2018
2	Pre-Amplifier	Mini-Circuits	EMC 9135	980283	Mar. 26, 2018
3	Trilog-Broadband Antenna	Schwarzbeck	VULB9168	586	Mar. 26, 2018
4	Trilog-Broadband Antenna	Schwarzbeck	VULB9168	587	Mar. 26, 2018
5	Cable	emci	LMR-400(5 m+11m+15 m)	N/A	Nov. 03, 2018
6	Cable	emci	LMR-400(5 m+8m+15 m)	N/A	Nov. 03, 2018
7	Measurement Software	Farad	EZ-EMC Ver.BTL-2A NT-1	N/A	N/A
8	Multi-Device Controller	ETS-Lindgren	2090	N/A	N/A
9	Attenuator	N/A	SA18N-06	6dB	Apr. 14, 2018
10	Attenuator	N/A	SA18N-06	6dB	Apr. 14, 2018
11	Receiver	Keysight	N9038A	MY54450004	Aug. 15, 2018
12	MXE EMI Receiver	Agilent	N9038A	MY53220133	Jun. 20, 2018

Remark: "N/A" denotes no model name, no serial no. or no calibration specified.
All calibration period of equipment list is one year.

4.1.3 TEST PROCEDURE

- The measuring distance of 10 m shall be used for measurements. The EUT was placed on the top of a rotating table 0.8 meter above the ground at a 10 meter semi-anechoic chamber. The table was rotated 360 degrees to determine the position of the highest radiation.(below 1GHz).
- The height of the equipment or of the substitution antenna shall be 0.8 m, the height of the test antenna shall vary between 1 m to 4 m. Both horizontal and vertical polarizations of the antenna are set to make the measurement.
- The initial step in collecting radiated emission data is a receiver peak detector mode pre-scanning the measurement frequency range. Significant peaks are then marked and then Quasi Peak detector mode re-measured.
- All readings are Peak unless otherwise stated QP in column of Note. Peak denotes that the Peak reading compliance with the QP Limits and then QP Mode measurement didn't perform. (below 1GHz)
- For the actual test configuration, please refer to the related Item - Block Diagram of system tested (please refer to 3.3).

4.1.4 DEVIATION FROM TEST STANDARD

No deviation

4.1.5 TEST SETUP

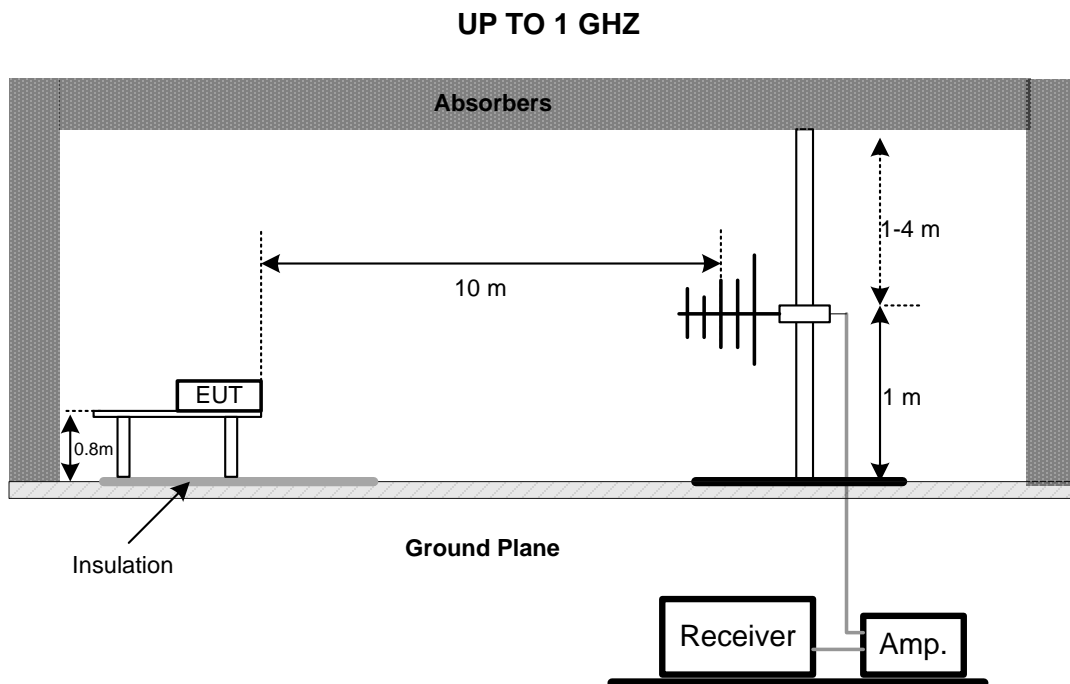

Note: The antenna can be moved between 1 to 4 meters above the ground.

4.1.6 MEASUREMENT DISTANCE

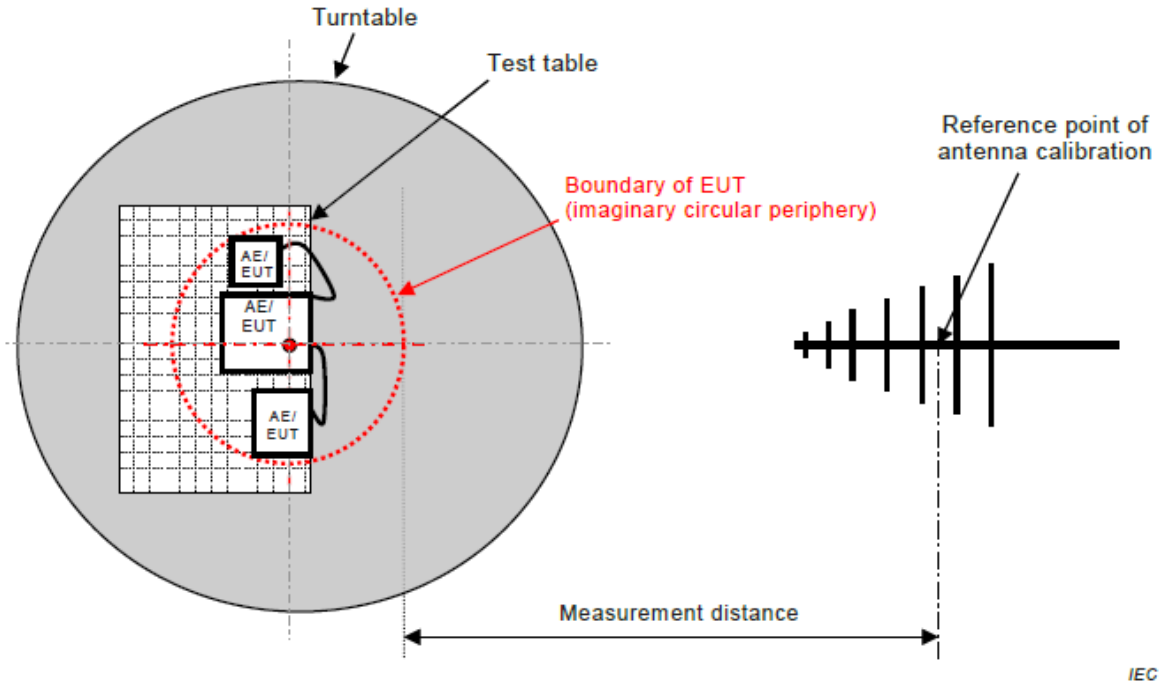

Figure C.1 – Measurement distance

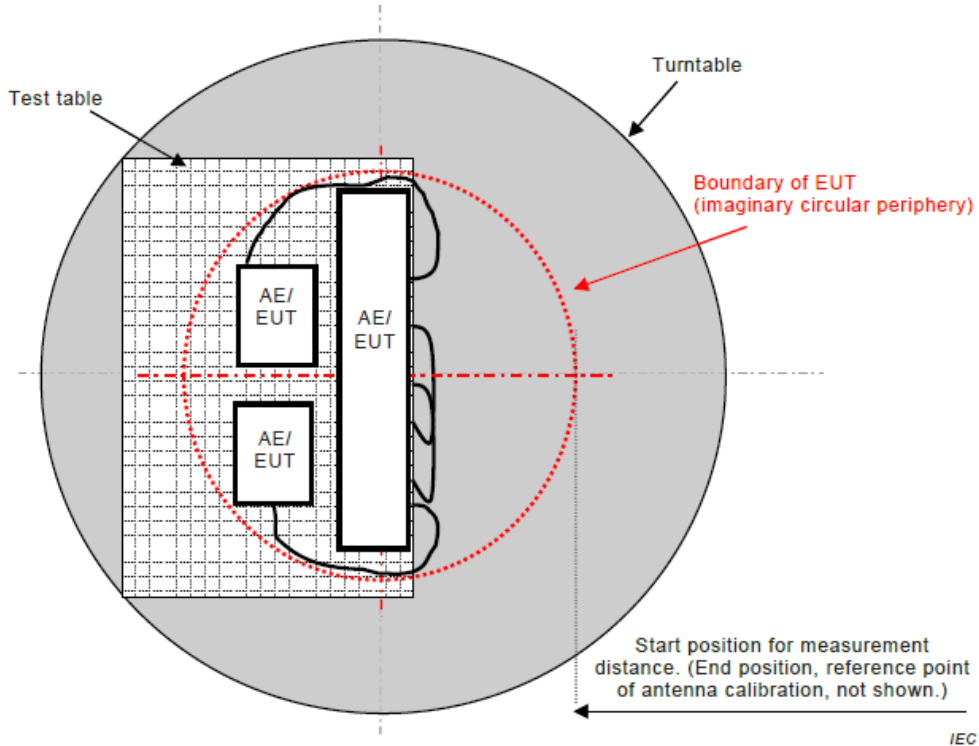
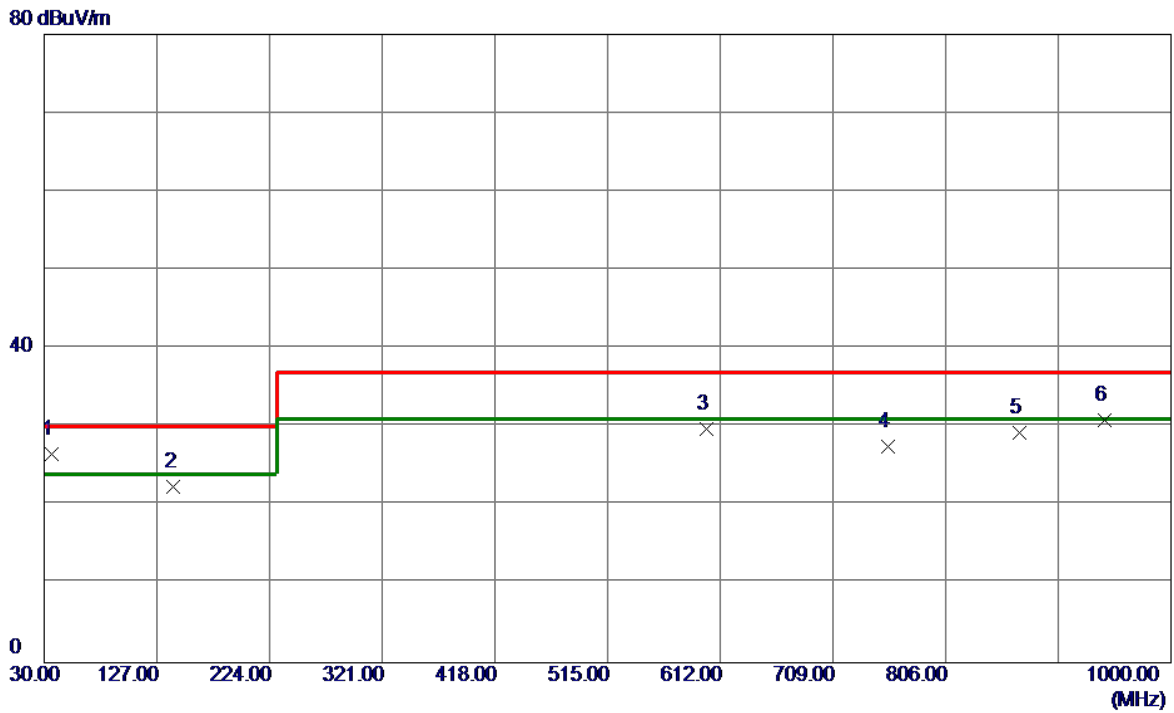

Figure C.2 – Boundary of EUT, Local AE and associated cabling

4.1.7 TEST RESULTS (UP TO 1 GHZ)

EUT	Gaming Mouse Mat	Model Name	RZ02-0250
Temperature	25°C	Relative Humidity	60%
Test Voltage	DC 5V	Polarization	Vertical
Test Mode	Operating		
Test Engineer	Helen Wang		



No.	Freq. MHz	Reading Level dBuV/m	Correct Factor dB	Measure ment dBuV/m	Limit dBuV/m	Margin dB	Detector
1 *	36.3050	50.20	-23.69	26.51	30.00	-3.49	QP
2	141.5500	44.48	-22.07	22.41	30.00	-7.59	QP
3	599.8750	43.82	-14.05	29.77	37.00	-7.23	QP
4	756.0450	38.66	-11.17	27.49	37.00	-9.51	QP
5	870.0200	39.22	-9.95	29.27	37.00	-7.73	QP
6	943.2550	38.96	-8.12	30.84	37.00	-6.16	QP

EUT	Gaming Mouse Mat	Model Name	RZ02-0250
Temperature	25°C	Relative Humidity	60%
Test Voltage	DC 5V	Polarization	Horizontal
Test Mode	Operating		
Test Engineer	Helen Wang		

80 dBuV/m

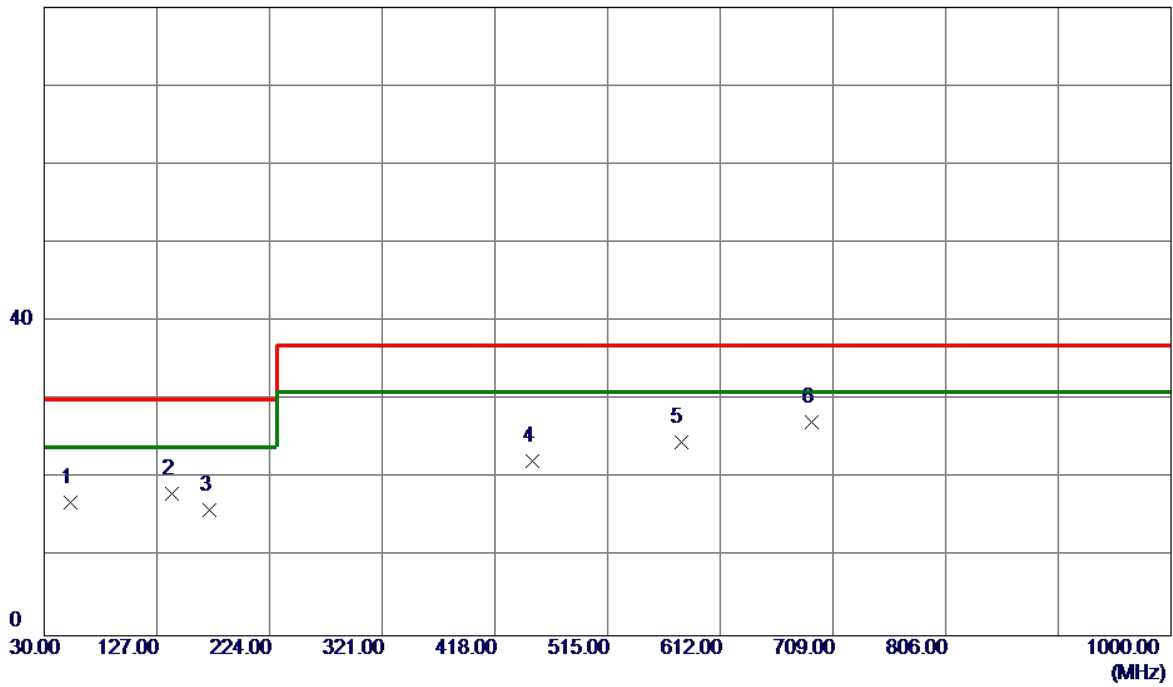

No.	Freq. MHz	Reading Level dBuV/m	Correct Factor dB	Measure ment dBuV/m	Limit dBuV/m	Margin dB	Detector
1	52.3100	33.01	-16.08	16.93	30.00	-13.07	QP
2	139.6100	33.76	-15.69	18.07	30.00	-11.93	QP
3	172.5900	31.27	-15.24	16.03	30.00	-13.97	QP
4	450.0100	31.77	-9.53	22.24	37.00	-14.76	QP
5	578.0500	31.56	-6.88	24.68	37.00	-12.32	QP
6 *	690.5700	31.99	-4.78	27.21	37.00	-9.79	QP

4.2 CONDUCTED EMISSION MEASUREMENT AT AC MAINS POWER PORTS

4.2.1 LIMITS

Requirements for conducted emissions from AC mains power ports of Class A equipment

Table clause	Frequency Range MHz	Coupling Device	Detector Type / bandwidth	Class A Limits (dB(μV))
A9.1	0.15 - 0.5	AMN	Quasi Peak / 9 kHz	79
	0.5 - 30			73
A9.2	0.15 - 0.5	AMN	Average / 9 kHz	66
	0.5 - 30			60

Apply A9.1 and A9.2 across the entire frequency range.

Requirements for conducted emissions from AC mains power ports of Class B equipment

Table clause	Frequency Range MHz	Coupling Device	Detector Type / bandwidth	Class B Limits (dB(μV))
A10.1	0.15 - 0.5	AMN	Quasi Peak / 9 kHz	66-56
	0.5 - 5			56
	5 - 30			60
A10.2	0.15 - 0.5	AMN	Average / 9 kHz	56-46
	0.5 - 5			46
	5 - 30			50

Apply A10.1 and A10.2 across the entire frequency range.

NOTE:

(1) The test result calculated as following:

Measurement Value = Reading Level + Correct Factor

Correct Factor = Insertion Loss + Cable Loss + Attenuator Factor(if use)

Margin Level = Measurement Value – Limit Value

4.2.2 MEASUREMENT INSTRUMENTS LIST

Item	Kind of Equipment	Manufacturer	Type No.	Serial No.	Calibrated until
1	Measurement Software	Farad	EZ-EMC Ver.NB-03A 1-01	N/A	N/A
2	LISN	EMCO	3816/2	00052765	Mar. 26, 2018
3	50Ω Terminator	SHX	TF2-3G-A	08122901	Mar. 26, 2018
4	TWO-LINE V-NETWORK	R&S	ENV216	101447	Mar. 26, 2018
5	EMI Test Receiver	R&S	ESCI	100382	Mar. 26, 2018
6	Cable	N/A	RG223	12m	Oct. 19, 2018

Remark: "N/A" denotes no model name, no serial no. or no calibration specified.

All calibration period of equipment list is one year.

4.2.3 TEST PROCEDURE

- a. The EUT was placed 0.8 meters from the horizontal ground plane with EUT being connected to the power mains through a line impedance stabilization network (LISN). All other support equipments powered from additional LISN(s). The LISN provide 50 Ohm/ 50uH of coupling impedance for the measuring instrument.
- b. Interconnecting cables that hang closer than 40 cm to the ground plane shall be folded back and forth in the center forming a bundle 30 to 40 cm long.
- c. I/O cables that are not connected to a peripheral shall be bundled in the center. The end of the cable may be terminated, if required, using the correct terminating impedance. The overall length shall not exceed 1 m.
- d. LISN at least 80 cm from nearest part of EUT chassis.
- e. For the actual test configuration, please refer to the related Item –EUT Test Photos.

4.2.4 DEVIATION FROM TEST STANDARD

No deviation

4.2.5 TEST SETUP

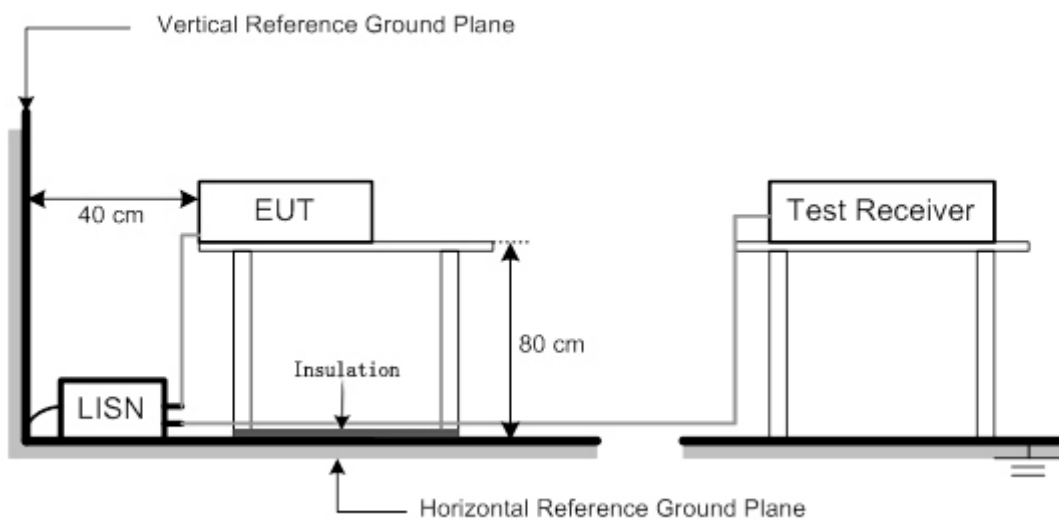

4.2.6 TEST RESULTS

EUT	Gaming Mouse Mat	Model Name	RZ02-0250
Temperature	25°C	Relative Humidity	53%
Test Voltage	DC 5V	Phase	Line
Test Mode	Operating		
Test Engineer	Helen Wang		

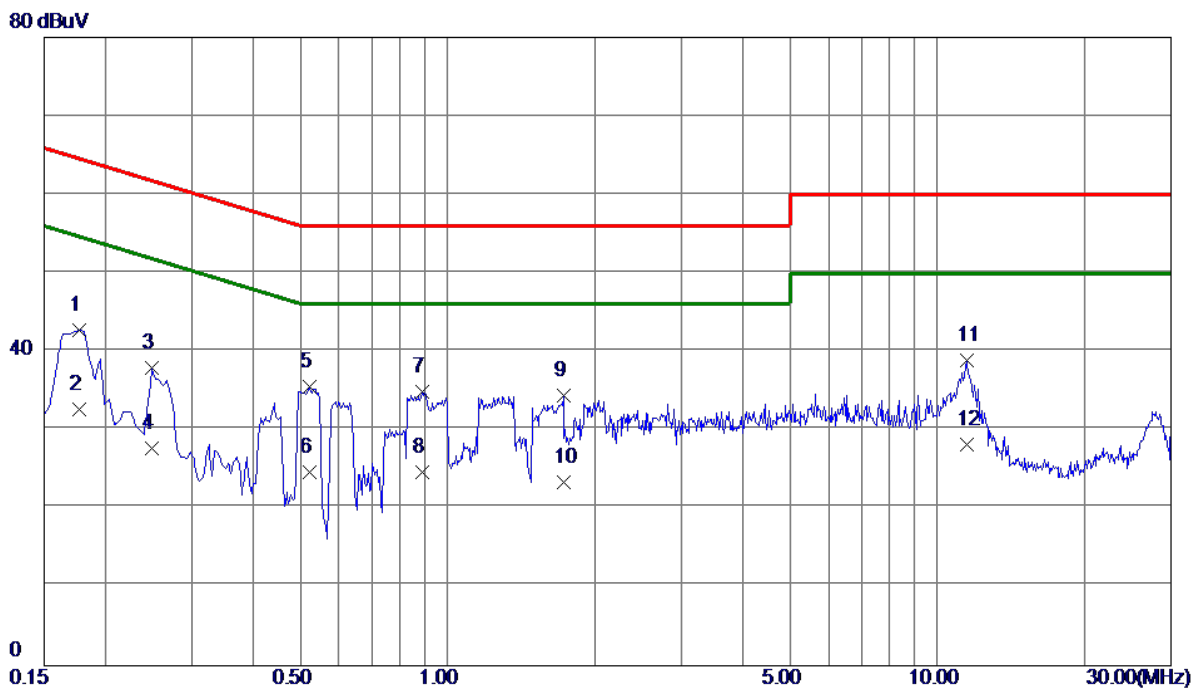

No.	Freq. MHz	Reading Level dBuV	Correct Factor dB	Measure ment dBuV	Limit dBuV	Margin dB	Detector
1	0.1770	32.91	9.78	42.69	64.63	-21.94	QP
2	0.1770	22.80	9.78	32.58	54.63	-22.05	AVG
3	0.2490	28.14	9.76	37.90	61.79	-23.89	QP
4	0.2490	17.90	9.76	27.66	51.79	-24.13	AVG
5 *	0.5235	25.68	9.80	35.48	56.00	-20.52	QP
6	0.5235	14.90	9.80	24.70	46.00	-21.30	AVG
7	0.8880	25.02	9.85	34.87	56.00	-21.13	QP
8	0.8880	14.80	9.85	24.65	46.00	-21.35	AVG
9	1.7250	24.55	9.91	34.46	56.00	-21.54	QP
10	1.7250	13.50	9.91	23.41	46.00	-22.59	AVG
11	11.4584	28.42	10.40	38.82	60.00	-21.18	QP
12	11.4584	17.80	10.40	28.20	50.00	-21.80	AVG

EUT	Gaming Mouse Mat	Model Name	RZ02-0250
Temperature	25°C	Relative Humidity	53%
Test Voltage	DC 5V	Phase	Neutral
Test Mode	Operating		
Test Engineer	Helen Wang		

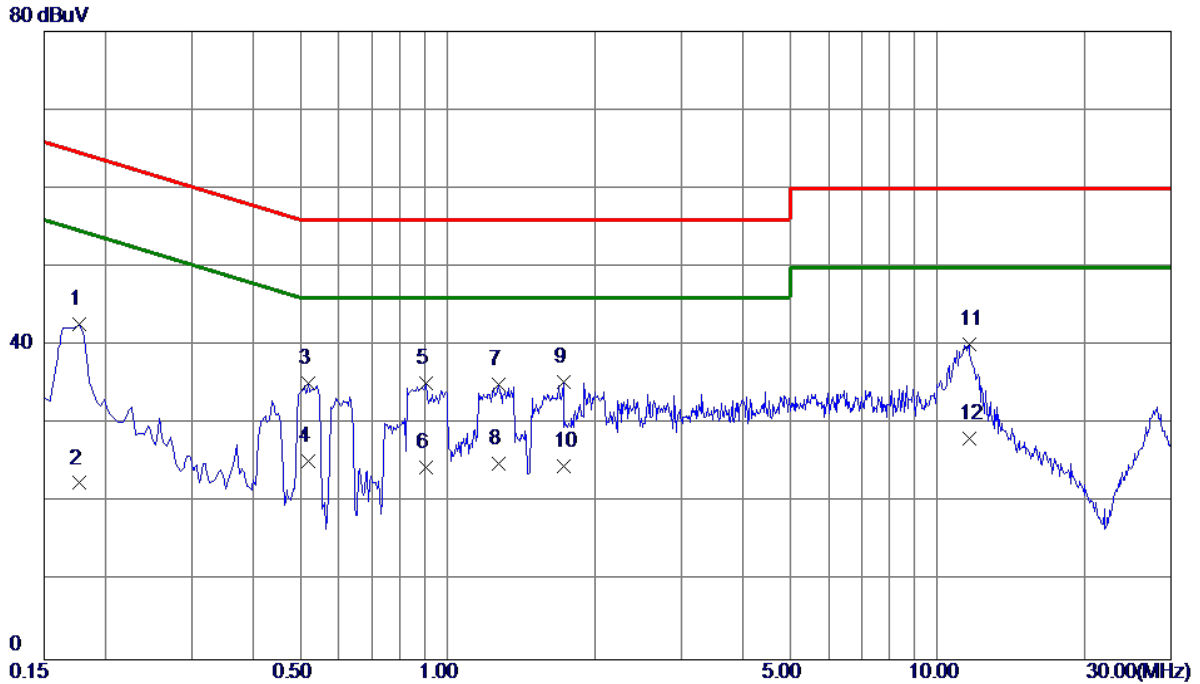

No.	Freq. MHz	Reading Level dBuV	Correct Factor dB	Measure ment dBuV	Limit dBuV	Margin dB	Detector
1	0.1770	32.98	9.68	42.66	64.63	-21.97	QP
2	0.1770	12.80	9.68	22.48	54.63	-32.15	AVG
3	0.5190	25.45	9.70	35.15	56.00	-20.85	QP
4	0.5190	15.60	9.70	25.30	46.00	-20.70	AVG
5	0.9060	25.39	9.74	35.13	56.00	-20.87	QP
6	0.9060	14.80	9.74	24.54	46.00	-21.46	AVG
7	1.2705	25.30	9.76	35.06	56.00	-20.94	QP
8	1.2705	15.20	9.76	24.96	46.00	-21.04	AVG
9	1.7250	25.60	9.81	35.41	56.00	-20.59	QP
10	1.7250	14.90	9.81	24.71	46.00	-21.29	AVG
11 *	11.5935	29.79	10.38	40.17	60.00	-19.83	QP
12	11.5935	17.81	10.38	28.19	50.00	-21.81	AVG

5. EMC IMMUNITY TEST

5.1 STANDARD COMPLIANCE/SEVERITY LEVEL/CRITERIA

Tests Standard No.	Test Specification Level / Test Mode	Test Ports	Criteria
Electrostatic discharge EN 61000-4-2 (ESD)	±8 kV air discharge ±4 kV contact discharge (Direct Mode)	Enclosure	B
	±4kV HCP discharge ±4kV VCP discharge (Indirect Mode)	Enclosure	B
Radiated, radio-frequency, electromagnetic field immunity EN 61000-4-3 (RS)	80 MHz to 1000 MHz 3V/m(unmodulated, r.m.s), 1 kHz, 80%, AM modulated	Enclosure	A
Electrical fast transient/burst immunity EN 61000-4-4 (EFT/Burst)	±0.5kV(peak) 5/50ns Tr/Th 5kHz Repetition Frequency (100kHz Repetition Frequency for xDSL equipment)	Signal ports and telecommunication ports (Only applicable to cable length>3 m)	B
	±0.5kV(peak) 5/50ns Tr/Th 5kHz Repetition Frequency	DC Power Ports	B
	±1 kV(peak) 5/50ns Tr/Th 5kHz Repetition Frequency	AC Power Ports	B
Surge immunity EN 61000-4-5 (Surges)	±1 kV(peak) 10/700 Tr/Th μs(NOTE) (without primary protection)	Signal ports and telecommunication ports (applicable only to ports connect directly to outdoor cables)	C
	±4 kV(peak) 10/700 Tr/Th μs(NOTE) (with primary protectors fitted)		C
	±0.5 kV(peak) 1.2/50(8/20) Tr/Th μs	DC Power Ports (applicable only to ports connect directly to outdoor cables)	B
	±1 kV(peak) 1.2/50(8/20) Tr/Th μs (line to line)	AC Power Ports	B
	±2 kV(peak) 1.2/50(8/20) Tr/Th μs (line to earth or ground)		B

Immunity to conducted disturbances, induced by radio-frequency fields EN 61000-4-6 (Injected Current)	0.15 MHz to 80 MHz 3V(unmodulated, r.m.s), 1kHz 80%, AM 150Ω source impedance	Signal ports and telecommunication ports (Only applicable to cable length>3 m)	A
	0.15 MHz to 80 MHz 3V(unmodulated, r.m.s), 1kHz 80%, AM 150Ω source impedance	DC Power Ports	A
	0.15 MHz to 80 MHz 3V(unmodulated, r.m.s), 1kHz 80%, AM 150Ω source impedance	AC Power Ports	A
Power frequency magnetic field immunity EN 61000-4-8 (PFMF)	50 Hz or 60Hz, 1A/m(r.m.s) μs	Enclosure	A
Voltage dips, short interruptions and voltage variations immunity EN 61000-4-11 (Voltage Interruption/Dips)	Voltage reduction > 95% 0.5 period Voltage reduction 30% 25 periods Voltage reduction > 95% 250 periods	AC Power Ports	B C C

Note.

Where the coupling network for the 10/700 μs waveform affects the functioning of high speed data ports, the test shall be carried out using a 1,2/50 (8/20) μs waveform and appropriate coupling network.

5.2 GENERAL PERFORMANCE CRITERIA

According to **EN55024** standard, the general performance criteria as following:

<p>Criterion A</p>	<p>The equipment shall continue to operate as intended without operator intervention. No degradation of performance or loss of function is allowed below a performance level specified by the manufacturer when the equipment is used as intended. The performance level may be replaced by a permissible loss of performance.</p> <p>If the minimum performance level or the permissible performance loss is not specified by the manufacturer, then either of these may be derived from the product description and documentation, and by what the user product description and documentation, and by what the user may reasonably expect from the equipment if used as intended.</p>
<p>Criterion B</p>	<p>After the test, the equipment shall continue to operate as intended without operator intervention. No degradation of performance or loss of function is allowed, after the application of the phenomenon below a performance level specified by the manufacturer, when the equipment is used as intended. The performance level may be replaced by a permissible loss of performance.</p> <p>During the test, degradation of performance is allowed. However, no change of operating state if stored data allowed to persist after the test. If the minimum performance level (or the permissible performance loss) is not specified by the manufacturer, then either of these may be derived from the product description and documentation, and by what the user may reasonably expect from the equipment if used as intended.</p>
<p>Criterion C</p>	<p>Loss of function is allowed, provided the function is self-recoverable, or can be restored by the operation of the controls by the user in accordance with the manufacturer's instructions.</p> <p>Functions, and/or information stored in non-volatile memory, or protected by a battery backup, shall not be lost.</p>

5.3 ELECTROSTATIC DISCHARGE IMMUNITY TEST (ESD)

5.3.1 TEST SPECIFICATION

Basic Standard	EN 61000-4-2
Discharge Impedance	330 ohm / 150 pF
Required Performance	B
Discharge Voltage	Air Discharge: ± 2 kV, ± 4 kV, ± 8 kV (Direct) Contact Discharge: ± 2 kV, ± 4 kV (Direct/Indirect)
Polarity	Positive & Negative
Number of Discharge	Air Discharge: min. 20 times at each test point Contact Discharge: min. 200 times in total
Discharge Mode	Single Discharge
Discharge Period	1 second minimum

5.3.2 MEASUREMENT INSTRUMENTS

Item	Kind of Equipment	Manufacturer	Type No.	Serial No.	Calibrated until
1	ESD Generator	TESEQ AG	NSG 437	450	Nov. 01, 2018

Remark: "N/A" denotes no model name, no serial No. or no calibration specified.

All calibration period of equipment list is one year.

5.3.3 TEST PROCEDURE

The test generator necessary to perform direct and indirect application of discharges to the EUT in the following manner:

- a. Contact discharge was applied to conductive surfaces (Direct) and coupling planes (Indirect) of the EUT.

During the test, it was performed with single discharges. For the single discharge time between successive single discharges was at least 1 second. The EUT shall be exposed to at least 200 discharges, 100 each at negative and positive polarity, at a minimum of four test points. One of the test points shall be subjected to at least 50 indirect discharges to the center of the front edge of the horizontal coupling plane. The remaining three test points shall each receive at least 50 direct contact discharges.

If no direct contact test points are available, then at least 200 indirect discharges shall be applied in the indirect mode. Test shall be performed at a maximum repetition rate of one discharge per second.

Vertical Coupling Plane (VCP):

The coupling plane, of dimensions 0.5m x 0.5m, is placed parallel to, and positioned at a distance 0.1m from, the EUT, with the Discharge Electrode touching the coupling plane.

The four faces of the EUT will be performed with electrostatic discharge.

Horizontal Coupling Plane (HCP):

The coupling plane is placed under to the EUT. The generator shall be positioned vertically at a distance of 0.1m from the EUT, with the Discharge Electrode touching the coupling plane.

The four faces of the EUT will be performed with electrostatic discharge.

- b. Air discharges at insulation surfaces of the EUT.

It was at least ten single discharges with positive and negative at the same selected point.

5.3.4 DEVIATION FROM TEST STANDARD

No deviation

5.3.5 TEST SETUP

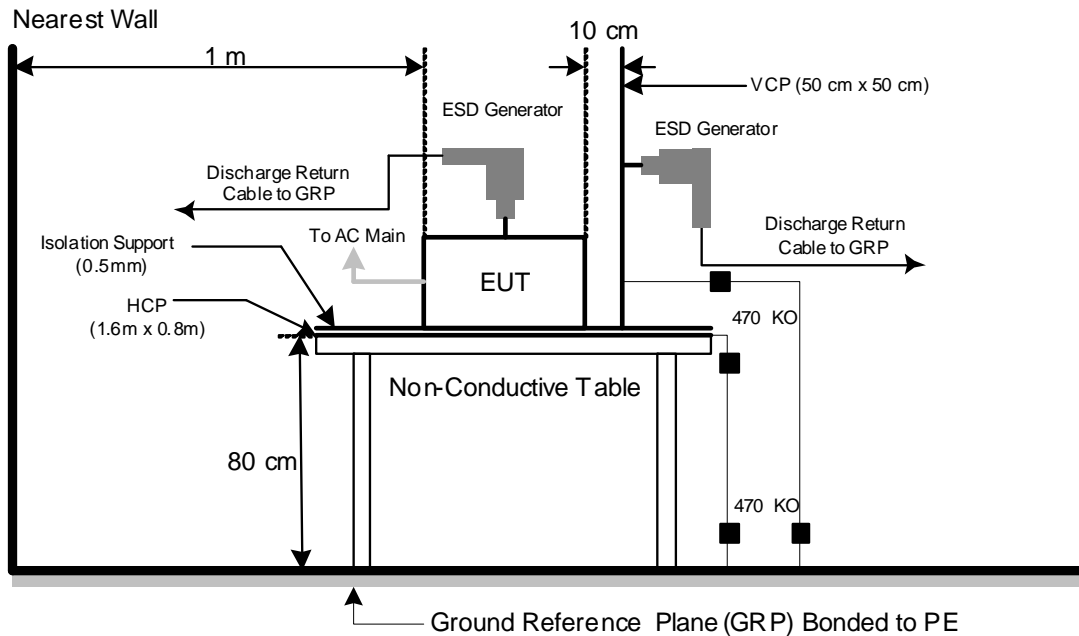

Note:

TABLE-TOP EQUIPMENT

The configuration consisted of a wooden table 0.8 meters high standing on the Ground Reference Plane. The GRP consisted of a sheet of aluminum at least 0.25mm thick, and 2.5 meters square connected to the protective grounding system. A Horizontal Coupling Plane (1.6m x 0.8m) was placed on the table and attached to the GRP by means of a cable with 940k total impedance. The equipment under test was installed in a representative system as described in EN 61000-4-2, and its cables were placed on the HCP and isolated by an insulating support of 0.5mm thickness. A distance of 1-meter minimum was provided between the EUT and the walls of the laboratory and any other metallic structure.

FLOOR-STANDING EQUIPMENT

The equipment under test was installed in a representative system as described in EN 61000-4-2, and its cables were isolated from the Ground Reference Plane by an insulating support of 0.1-meter thickness. The GRP consisted of a sheet of aluminum that is at least 0.25mm thick, and 2.5meters square connected to the protective grounding system and extended at least 0.5 meters from the EUT on all sides.

5.3.6 TEST RESULTS

EUT	Gaming Mouse Mat	Model Name	RZ02-0250
Temperature	25°C	Relative Humidity	56%
Test Voltage	AC 230V/50Hz	Pressure	1010hPa
Test Mode	Operating		

Mode	Air Discharge								Contact Discharge							
	2kV		4kV		8kV		- kV		2kV		4kV		- kV			
Location	P	N	P	N	P	N	P	N	P	N	P	N	P	N		
1	A	A	A	A	A	A	-	-	A	A	A	A	-	-		
2	A	A	A	A	A	A	-	-	-	-	-	-	-	-		
Criteria	B								-		B				-	
Result	A								-		A				-	
Judgment	PASS								-		PASS				-	

Mode	HCP Contact Discharge						VCP Contact Discharge							
	2kV		4kV		- kV		2kV		4kV		- kV			
Location	P	N	P	N	P	N	P	N	P	N	P	N		
1	A	A	A	A	-	-	A	A	A	A	-	-		
2	A	A	A	A	-	-	A	A	A	A	-	-		
3	A	A	A	A	-	-	A	A	A	A	-	-		
4	A	A	A	A	-	-	A	A	A	A	-	-		
Criteria	B						-		B				-	
Result	A						-		A				-	
Judgment	PASS						-		PASS				-	

Note:

- 1) P/N denotes the Positive/Negative polarity of the output voltage.
- 2) Test condition:
 Direct/Indirect(HCP/VCP) discharges: Minimum 50 times (Positive/Negative) at eachpoint.
 Air discharges: Minimum 20 times (Positive/Negative) at each point.
- 3) Test location(s) in which discharge (Air and contact discharge) to be applied illustrated by photos shown in next page(s)
- 4) The Indirect (HCP/VCP) discharges description of test point as following:
 1.left side; 2.right side; 3.front side; 4.rear side.
- 5) N/A - denotes test is not applicable in this test report
- 6) Criterion A: No observation of any performance degradation.
- 7) Criterion B: Some degradation of performance is observed but the equipment continues to operate as intended.
- 8) Criterion C: Loss of functionality, but self-recoverable by user, without loss of information or settings.

PHOTO(S) SHOWN THE LOCATION(S) OF ESD EVALUATED



5.4 RADIATED, RADIO-FREQUENCY, ELECTROMAGNETIC FIELD IMMUNITY TEST (RS)

5.4.1 TEST SPECIFICATION

Basic Standard	EN 61000-4-3
Required Performance	A
Frequency Range	80 MHz - 1000 MHz
Field Strength	3 V/m(unmodulated, r.m.s)
Modulation	1 kHz Sine Wave, 80%, AM Modulation
Frequency Step	1% of fundamental
Polarity of Antenna	Horizontal and Vertical
Test Distance	3 m
Antenna Height	1.5 m
Dwell Time	at least 3 seconds

5.4.2 MEASUREMENT INSTRUMENTS

Item	Kind of Equipment	Manufacturer	Type No.	Serial No.	Calibrated until
1	Power amplifier	MILMEGA	80RF1000-250	1064833	Aug. 20, 2020
2	Antenna	ETS	3142C	00047662	Mar. 26, 2018
3	Measurement Software	TOYO	IM5/RS Ver 3.8.050	N/A	N/A
4	MXG Analog Signal Generator	Agilent	N5181A	MY49060710	Aug. 20, 2018

Remark: "N/A" denotes no model name, no serial No. or no calibration specified.

All calibration period of equipment list is one year.

5.4.3 TEST PROCEDURE

The EUT and support equipment, which are placed on a table that is 0.8 meter above ground and the testing was performed in a fully-anechoic chamber.

The testing distance from antenna to the EUT was 3 meters.

The other condition as following manner:

- a. The field strength level was 3 V/m(unmodulated, r.m.s).
- b. The frequency range is swept from 80 MHz to 1000 MHz, with the signal 80%amplitude modulated with a 1 kHz sine wave. The rate of sweep did not exceed 1.5×10^{-3} decade/s. Where the frequency range is swept incrementally, the step size was 1% of fundamental.
- c. The dwell time at each frequency shall be not less than the time necessary for the EUT to be able to respond.
- d. The test was performed with the EUT exposed to both vertically and horizontally polarized fields on each of the four sides.

5.4.4 DEVIATION FROM TEST STANDARD

No deviation

5.4.5 TEST SETUP

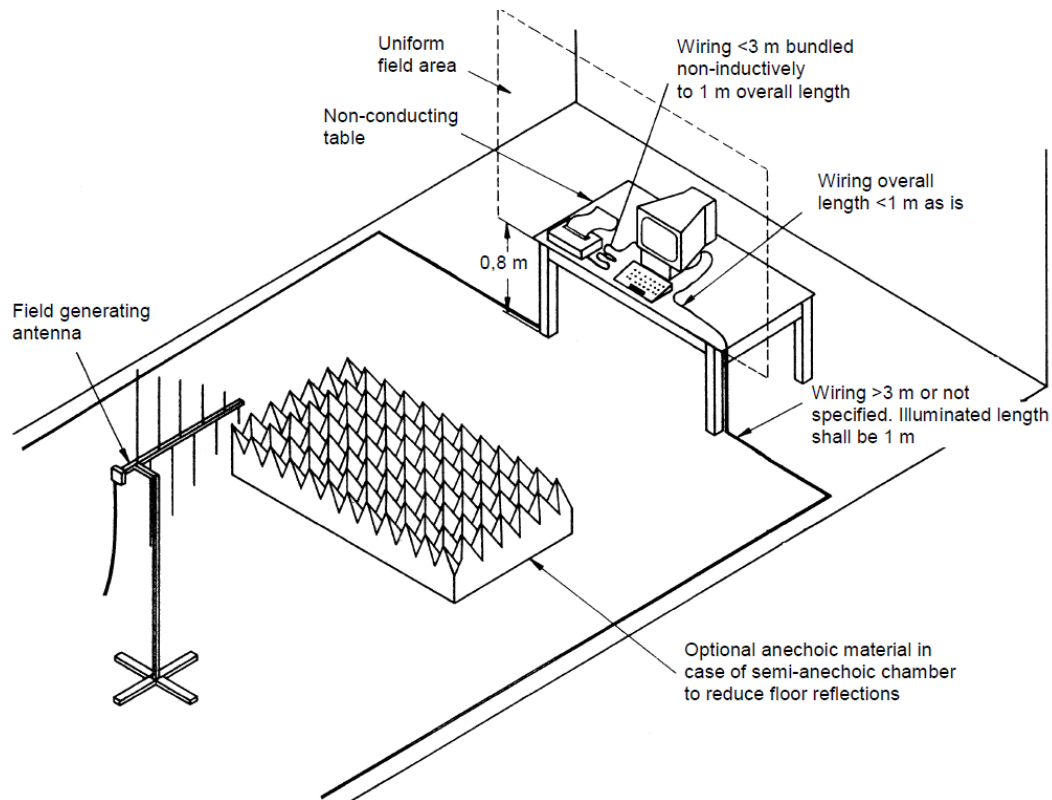

Note:

TABLE-TOP EQUIPMENT

The EUT installed in a representative system as described in EN 61000-4-3 was placed on a non-conductive table 0.8 meters in height. The system under test was connected to the power and signal wire according to relevant installation instructions.

FLOOR-STANDING EQUIPMENT

The EUT installed in a representative system as described in EN 61000-4-3 was placed on a non-conductive wood support 0.1 meters in height. The system under test was connected to the power and signal wire according to relevant installation instructions.

5.4.6 TEST RESULTS

EUT	Gaming Mouse Mat	Model Name	RZ02-0250
Temperature	25°C	Relative Humidity	56%
Test Voltage	AC 230V/50Hz		
Test Mode	Operating		

Frequency Range (MHz)	RF Field Position	R.F. Field Strength	Azimuth	Criterion	Result	Judgment
80 - 1000	H / V	3V (unmodulated, r.m.s) AM Modulated 1000Hz, 80%	0	A	A	PASS
			90			
			180			
			270			

Note:

- 1) P/N denotes the Positive/Negative polarity of the output voltage.
- 2) N/A - denotes test is not applicable in this test report.
- 3) Criterion A: No observation of any performance degradation.
- 4) Criterion B: Some degradation of performance is observed but the equipment continues to operate as intended.
- 5) Criterion C: Loss of functionality, but self-recoverable by user, without loss of information or settings.

5.5 ELECTRICAL FAST TRANSIENT/BURST IMMUNITY TEST (EFT/BURST)

5.5.1 TEST SPECIFICATION

Basic Standard	EN 61000-4-4
Required Performance	B
Test Voltage	Power Line: ± 1 kV
Polarity	Positive & Negative
Impulse Frequency	5 kHz: except for xDSL equipment 100 kHz: only for single lines of xDSL equipment.
Impulse Wave shape	5/50 ns
Burst Duration	15 ms
Burst Period	300 ms
Test Duration	Not less than 1 min.

5.5.2 MEASUREMENT INSTRUMENTS

Item	Kind of Equipment	Manufacturer	Type No.	Serial No.	Calibrated until
1	THE MODULAR SOLUTION FOR 6 KV APPLICATIONS	Teseq	NSG 3060	1423	Aug. 20, 2018
2	Measurement Software	Teseq	Win 3000 Version 1.2.0	N/A	N/A

Remark: "N/A" denotes no model name, no serial No. or no calibration specified.

All calibration period of equipment list is one year.

5.5.3 TEST PROCEDURE

The EUT and support equipment(s) are placed on a table that is 0.8 meter high above a metal ground plane and should be located 0.1 m \pm 0.01m high above the Ground Reference Plane (1m*1m min. and 0.65mm thick min).

The other condition as following manner:

- a. The length of power cord between the coupling device and the EUT should not exceed 1 meter.
- b. Both positive and negative polarity discharges were applied.
- c. The duration time of each test sequential was 1 minute

5.5.4 DEVIATION FROM TEST STANDARD

No deviation

5.5.5 TEST SETUP

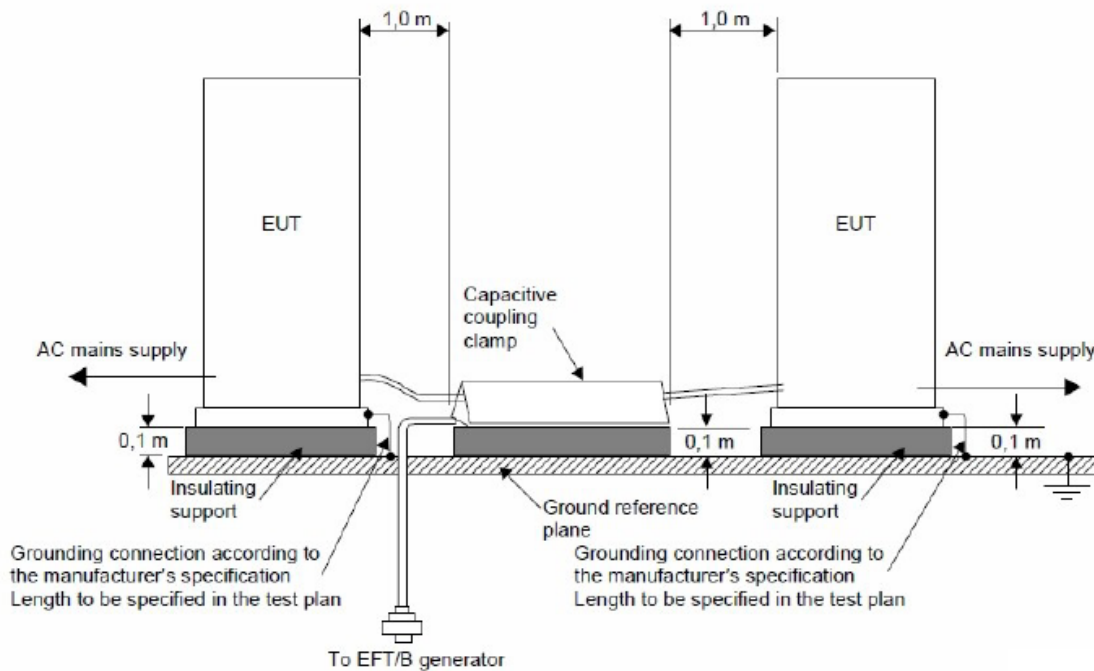
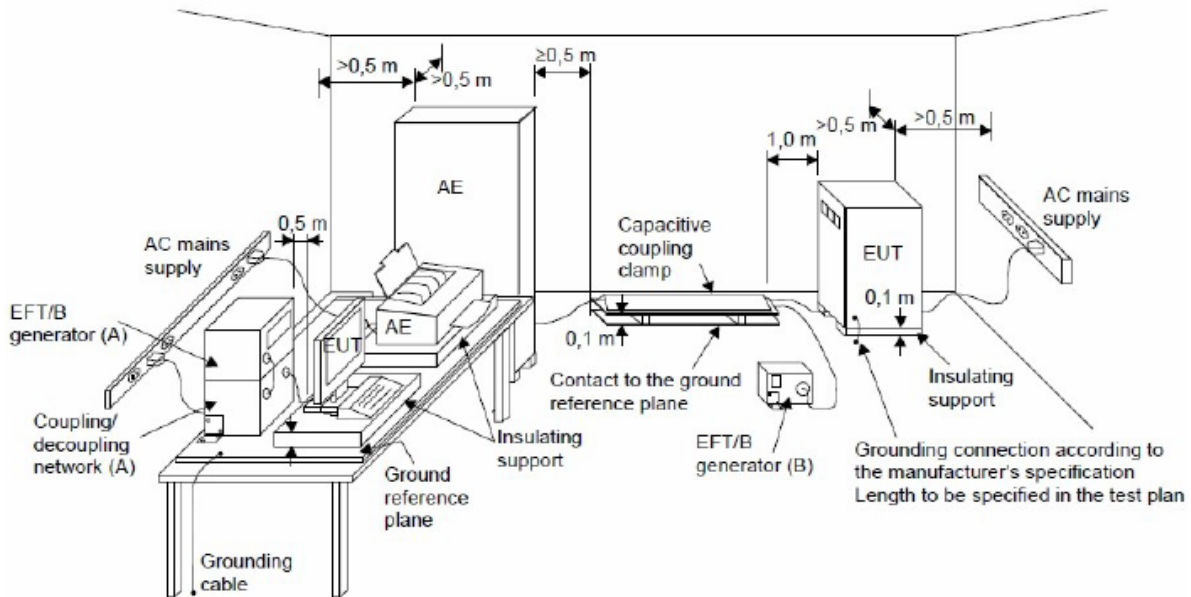

Note:

TABLE-TOP EQUIPMENT

The configuration consisted of a wooden table (0.8m high) standing on the Ground Reference Plane and should be located 0.1 m+/- 0.01m above the Ground Reference Plane. The GRP consisted of a sheet of aluminum (at least 0.25mm thick and 2.5m square) connected to the protective grounding system. A minimum distance of 0.5m was provided between the EUT and the walls of the laboratory or any other metallic structure.

FLOOR-STANDING EQUIPMENT

The EUT installed in a representative system as described in EN 61000-4-4 and its cables were isolated from the Ground Reference Plane by an insulating support that is 0.1-meter thick. The GRP consisted of a sheet of aluminum (at least 0.25mm thick and 2.5m square) connected to the protective grounding system.

5.5.6 TEST RESULTS

EUT	Gaming Mouse Mat	Model Name	RZ02-0250
Temperature	25°C	Relative Humidity	56%
Test Voltage	AC 230V/50Hz		
Test Mode	Operating		

EUT Ports Tested		Polarity	Repetition Frequency	Test Level 1kV	Criterion	Result	Judgment
AC Power Port	Line (L)	+	5 kHz	A	B	A	PASS
		-	5 kHz	A			
	Neutral (N)	+	5 kHz	A	B	A	PASS
		-	5 kHz	A			
	Ground (PE)	+	5 kHz	A	B	A	PASS
		-	5 kHz	A			

Note:

- 1) P/N denotes the Positive/Negative polarity of the output voltage.
- 2) N/A - denotes test is not applicable in this test report
- 3) Criterion A: No observation of any performance degradation.
- 4) Criterion B: Some degradation of performance is observed but the equipment continues to operate as intended.
- 5) Criterion C: Loss of functionality, but self-recoverable by user, without loss of information or settings.

5.6 SURGE IMMUNITY TEST

5.6.1 TEST SPECIFICATION

Basic Standard	EN 61000-4-5
Required Performance	B
Wave-Shape	Combination Wave for power lines 1.2/50 us Open Circuit Voltage 8 /20 us Short Circuit Current
Test Voltage	Power Line: ± 0.5 kV, ± 1 kV, ± 2 kV
Surge Input/Output	L-N, L-PE, N-PE
Generator Source Impedance	2 ohm between networks 12 ohm between network and ground
Polarity	Positive/Negative
Phase Angle:	AC Port: $0^\circ/90^\circ/180^\circ/270^\circ$
Pulse Repetition Rate	1 time / min. (maximum)
Number of Tests	5 positive and 5 negative at selected points

5.6.2 MEASUREMENT INSTRUMENTS

Item	Kind of Equipment	Manufacturer	Type No.	Serial No.	Calibrated until
1	THE MODULAR SOLUTION FOR 6 KV APPLICATIONS	Teseq	NSG 3060	1423	Aug. 20, 2018
2	Measurement Software	Teseq	Win 3000 Version 1.2.0	N/A	N/A

Remark: "N/A" denotes no model name, no serial No. or no calibration specified.
All calibration period of equipment list is one year.

5.6.3 TEST PROCEDURE

a. For EUT power supply:

The surge is to be applied to the EUT power supply terminals via the capacitive coupling network. Decoupling networks are required in order to avoid possible adverse effects on equipment not under test that may be powered by the same lines, and to provide sufficient decoupling impedance to the surge wave. The power cord between the EUT and the coupling/decoupling networks shall be 2meters in length (or shorter).

b. For test applied to unshielded unsymmetrically operated interconnection lines of EUT :

The surge is applied to the lines via the capacitive coupling. The coupling /decoupling networks shall not influence the specified functional conditions of the EUT. The interconnection line between the EUT and the coupling/decoupling networks shall be 2 meters in length (or shorter).

c. For test applied to unshielded symmetrically operated interconnection /telecommunication lines of EUT :

The surge is applied to the lines via gas arrestors coupling. Test levels below the ignition point of the coupling arrester cannot be specified. The interconnection line between the EUT and the coupling/decoupling networks shall be 2 meters in length (or shorter).

5.6.4 DEVIATION FROM TEST STANDARD

No deviation

5.6.5 TEST SETUP

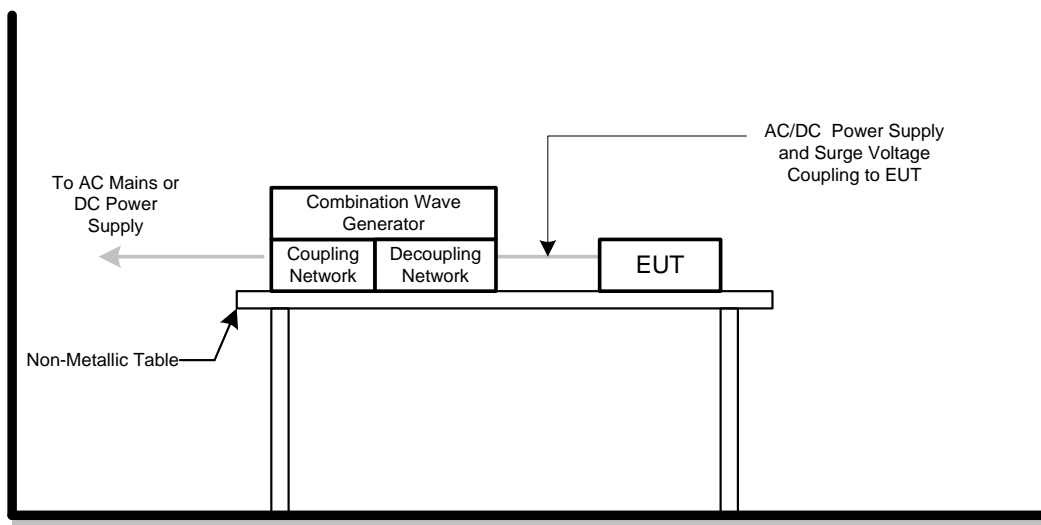

5.6.6 TEST RESULTS

EUT	Gaming Mouse Mat	Model Name	RZ02-0250
Temperature	25°C	Relative Humidity	56%
Test Voltage	AC 230V/50Hz		
Test Mode	Operating		

Wave Form EUT Ports Tested		1.2/50(8/20)Tr/Thµs						Criterion	Result	Judgment
		Polarity	Phase	Voltage						
				0.5kV	1kV	-- kV	-- kV			
AC	L – N (2 ohm)	+/-	0°	A	A	-	-	B	A	PASS
		+/-	90°	A	A	-	-			
		+/-	180°	A	A	-	-			
		+/-	270°	A	A	-	-			

Wave Form EUT Ports Tested		1.2/50(8/20)Tr/Thµs						Criterion	Result	Judgment
		Polarity	Phase	Voltage						
				0.5kV	1kV	2kV	-- kV			
AC	L – PE (12 ohm)	+/-	0°	A	A	A	-	B	A	PASS
		+/-	90°	A	A	A	-			
		+/-	180°	A	A	A	-			
		+/-	270°	A	A	A	-			
	N – PE (12 ohm)	+/-	0°	A	A	A	-	B	A	PASS
		+/-	90°	A	A	A	-			
		+/-	180°	A	A	A	-			
		+/-	270°	A	A	A	-			

Note:

- 1) Polarity and Numbers of Impulses: 5 Pst / Ngt at each tested mode
- 2) N/A - denotes test is not applicable in this Test Report
- 3) Criterion A: No observation of any performance degradation.
- 4) Criterion B: Some degradation of performance is observed but the equipment continues to operate as intended.
- 5) Criterion C: Loss of functionality, but self-recoverable by user, without loss of information or settings.

5.7 IMMUNITY TO CONDUCTED DISTURBANCES, INDUCED BY RADIO-FREQUENCY FIELDS TEST (CS)

5.7.1 TEST SPECIFICATION

Basic Standard	EN 61000-4-6
Required Performance	A
Frequency Range	0.15 MHz - 80 MHz
Field Strength	3 V (unmodulated, r.m.s.)
Modulation	1 kHz Sine Wave, 80%, AM Modulation
Frequency Step	1% of fundamental
Dwell Time	at least 3 seconds

5.7.2 MEASUREMENT INSTRUMENTS

Item	Kind of Equipment	Manufacturer	Type No.	Serial No.	Calibrated until
1	Power CDN	FCC	FCC-801-M2/M3-16A	100270	Mar. 26, 2018
2	Power Amplifier	Teseq	CBA230M-080	T43748	Mar. 26, 2018
3	Signal Generator	HP	8648A	3636A02964	Mar. 26, 2018
4	Measurement Software	Farad	EZ-CS(V2.0.1.2)	N/A	N/A

Remark: "N/A" denotes no model name, no serial No. or no calibration specified.
All calibration period of equipment list is one year.

5.7.3 TEST PROCEDURE

The EUT and support equipment, are placed on a table that is 0.8 meter above a metal ground plane measured 1m*1m min. and 0.65mm thick min.

The other condition as following manner:

- a. The field strength level was 3 V (unmodulated, r.m.s.)
- b. The frequency range is swept from 150 kHz to 80 MHz, with the signal 80% amplitude modulated with a 1 kHz sine wave. The rate of sweep did not exceed 1.5×10^{-3} decade/s. Where the frequency range is swept incrementally, the step size was 1% of fundamental.
- c. The dwell time at each frequency shall be not less than the time necessary for the EUT to be able to respond.

5.7.4 DEVIATION FROM TEST STANDARD

No deviation

5.7.5 TEST SETUP

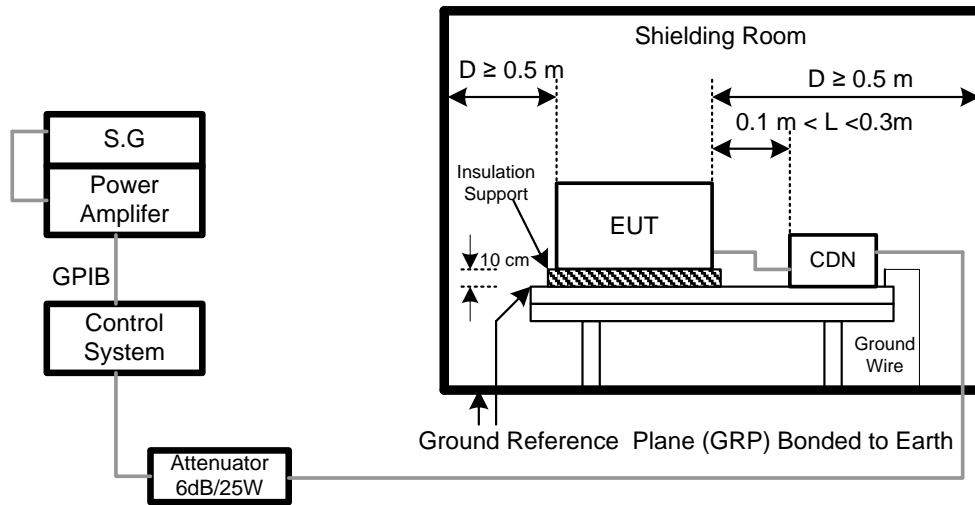

NOTE:

FLOOR-STANDING EQUIPMENT

The equipment to be tested is placed on an insulating support of 0.1 meters height above a ground reference plane. All relevant cables shall be provided with the appropriate coupling and decoupling devices at a distance between 0.1 meters and 0.3 meters from the projected geometry of the EUT on the ground reference plane.

5.7.6 TEST RESULTS

EUT	Gaming Mouse Mat	Model Name	RZ02-0250
Temperature	25°C	Relative Humidity	56%
Test Voltage	AC 230V/50Hz		
Test Mode	Operating		

Test Ports (Mode)	Freq.Range (MHz)	Field Strength	Criteria	Results	Judgment
Input/ Output AC.PowerPort	0.15 ---80	3V(unmodulated, r.m.s) AM Modulated 1000Hz, 80%	A	A	PASS
Input/ Output DC. PowerPort	0.15 --- 80		A	N/A	N/A
Signal Line (N/A)	0.15 --- 80		A	N/A	N/A

Note:

- 1). N/A - denotes test is not applicable in this test report.
- 2) Criterion A: No observation of any performance degradation.
- 3) Criterion B: Some degradation of performance is observed but the equipment continues to operate as intended.
- 4) Criterion C: Loss of functionality, but self-recoverable by user, without loss of information or settings.

5.8 POWER FREQUENCY MAGNETIC FIELD IMMUNITY TEST (PFMF)

5.8.1 TEST SPECIFICATION

Basic Standard	EN 61000-4-8
Required Performance	A
Frequency Range	50/60 Hz
Field Strength	1 A/m
Observation Time	1 minute
Inductance Coil	Rectangular type, 1mx1m

5.8.2 MEASUREMENT INSTRUMENTS

Item	Kind of Equipment	Manufacturer	Type No.	Serial No.	Calibrated until
1	Magnetic Field test Generator	FCC	F-1000-4-8-G-125A	04032	Mar. 26, 2018
2	Magnetic Field immunity loop	Thermo KeyTek	F-1000-4-8/9/10-L-1M	04024	Mar. 26, 2018

Remark: "N/A" denotes no model name, no serial No. or no calibration specified.

All calibration period of equipment list is one year.

5.8.3 TEST PROCEDURE

The EUT and support equipment, are placed on a table that is 0.8 meter above a metal ground plane measured 1m*1m min. and 0.65mm thick min.

The other condition as following manner:

- a. The equipment cabinets shall be connected to the safety earth directly on the GRP via the earth terminal of the EUT.
- b. The cables supplied or recommended by the equipment manufacturer shall be used. 1 meter of all cables used shall be exposed to the magnetic field.

5.8.4 DEVIATION FROM TEST STANDARD

No deviation

5.8.5 TEST SETUP

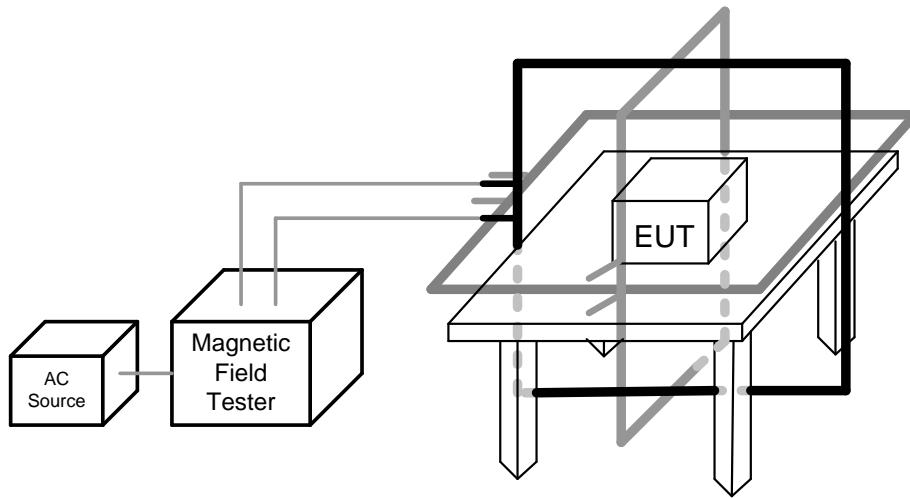

Note:

TABLE-TOP EQUIPMENT

The equipment shall be subjected to the test magnetic field by using the induction coil of standard dimension (1 m x 1 m). The induction coil shall then be rotated by 90 degrees in order to expose the EUT to the test field with different orientations.

FLOOR-STANDING EQUIPMENT

The equipment shall be subjected to the test magnetic field by using induction coils of suitable dimensions. The test shall be repeated by moving and shifting the induction coils, in order to test the whole volume of the EUT for each orthogonal direction. The test shall be repeated with the coil shifted to different positions along the side of the EUT, in steps corresponding to 50 percent of the shortest side of the coil. The induction coil shall then be rotated by 90 degrees in order to expose the EUT to the test field with different orientations.

5.8.6 TEST RESULTS

EUT	Gaming Mouse Mat	Model Name	RZ02-0250
Temperature	25°C	Relative Humidity	56%
Test Voltage	AC 230V/50Hz		
Test Mode	Operating		

50Hz

Test Mode	Test Level	Antenna aspect	Duration (s)	Criteria	Results	Judgment
Enclosure	1 A/m	X	60	A	A	PASS
Enclosure	1 A/m	Y	60	A	A	PASS
Enclosure	1 A/m	Z	60	A	A	PASS

60Hz

Test Mode	Test Level	Antenna aspect	Duration (s)	Criteria	Results	Judgment
Enclosure	1 A/m	X	60	A	A	PASS
Enclosure	1 A/m	Y	60	A	A	PASS
Enclosure	1 A/m	Z	60	A	A	PASS

Note:

- 1). N/A - denotes test is not applicable in this test report.
- 2) Criterion A: No observation of any performance degradation.
- 3) Criterion B: Some degradation of performance is observed but the equipment continues to operate as intended.
- 4) Criterion C: Loss of functionality, but self-recoverable by user, without loss of information or settings.

5.9 VOLTAGE DIPS, SHORT INTERRUPTIONS AND VOLTAGE VARIATIONS IMMUNITY TEST

5.9.1 TEST SPECIFICATION

Basic Standard	EN 61000-4-11
Required Performance	B (For >95% Voltage Dips) C (For 30% Voltage Dips) C (For >95% Voltage Interruptions)
Test Duration Time	Minimum three test events in sequence
Interval between Event	Minimum ten seconds
Phase Angle	0°/180°
Test Cycle	3 times

5.9.2 MEASUREMENT INSTRUMENTS

Item	Kind of Equipment	Manufacturer	Type No.	Serial No.	Calibrated until
1	THE MODULAR SOLUTION FOR 6 KV APPLICATIONS	Teseq	NSG 3060	1423	Aug. 20, 2018
2	Measurement Software	Teseq	Win 3000 Version 1.2.0	N/A	N/A

Remark: "N/A" denotes no model name, no serial No. or no calibration specified.

All calibration period of equipment list is one year.

5.9.3 TEST PROCEDURE

The EUT shall be tested for each selected combination of test levels and duration with a sequence of three dips/interruptions with intervals of 10 s minimum (between each test event). Each representative mode of operation shall be tested. Abrupt changes in supply voltage shall occur at zero crossings of the voltage waveform.

5.9.4 DEVIATION FROM TEST STANDARD

No deviation

5.9.5 TEST SETUP

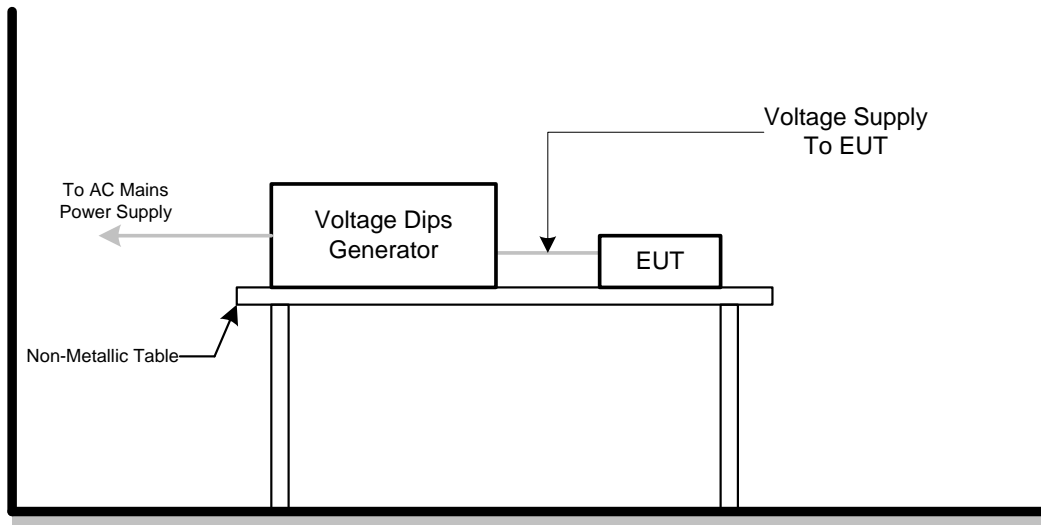

5.9.6 TEST RESULTS

EUT	Gaming Mouse Mat	Model Name	RZ02-0250
Temperature	25°C	Relative Humidity	56%
Test Voltage	AC 230V/50Hz		
Test Mode	Operating		

AC 100V/50Hz				
Voltage Reduction	Periods	Criteria	Results	Judgment
Voltage dip > 95%	0.5	B	A	PASS
Voltage dip 30%	25	C	A	PASS
Interruption > 95%	250	C	C	PASS

AC 230V/50Hz				
Voltage Reduction	Periods	Criteria	Results	Judgment
Voltage dip > 95%	0.5	B	A	PASS
Voltage dip 30%	25	C	A	PASS
Interruption > 95%	250	C	C	PASS

AC 240V/50Hz				
Voltage Reduction	Periods	Criteria	Results	Judgment
Voltage dip > 95%	0.5	B	A	PASS
Voltage dip 30%	25	C	A	PASS
Interruption > 95%	250	C	C	PASS

Note:

- 1). N/A - denotes test is not applicable in this test report.
- 2) Criterion A: No observation of any performance degradation.
- 3) Criterion B: Some degradation of performance is observed but the equipment continues to operate as intended.
- 4) Criterion C: Loss of functionality, but self-recoverable by user, without loss of information or settings.

6. EUT TEST PHOTO

Radiated emissions up to 1 GHz

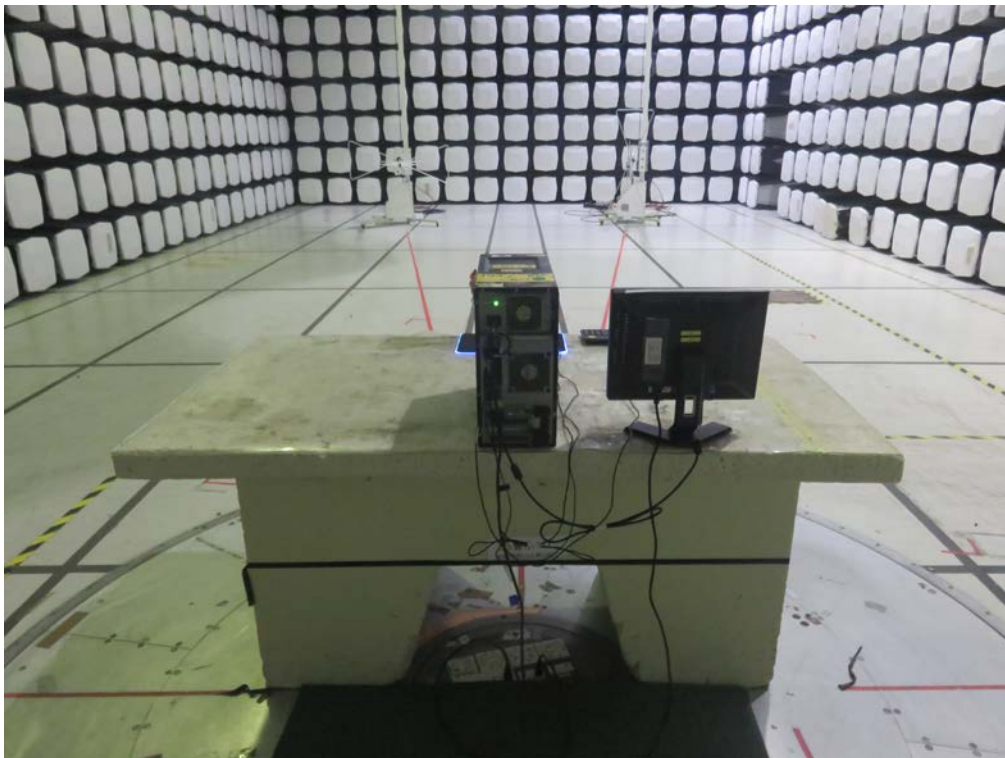
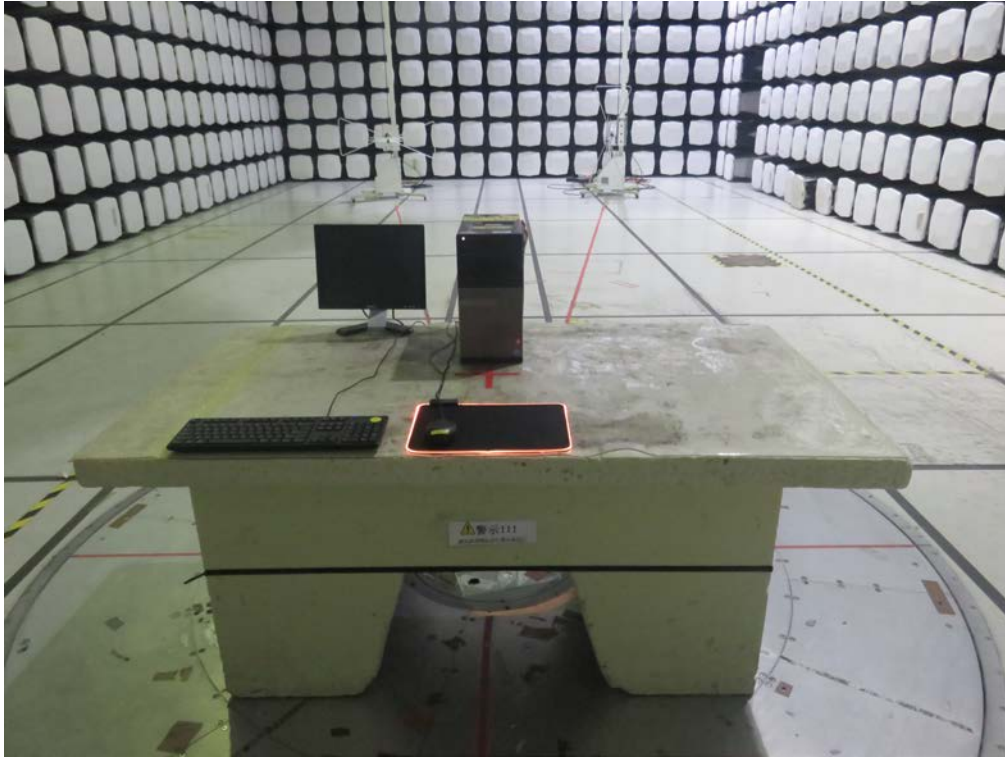

Conducted emissions AC mains power port

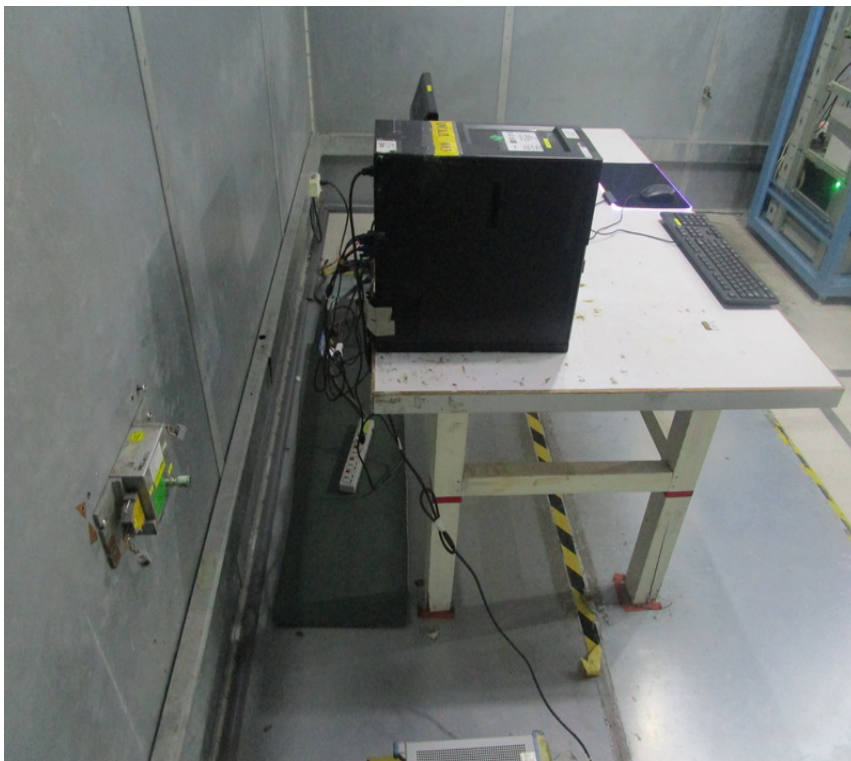

Electrostatic discharge immunity



Radiated, radio-frequency, electromagnetic field immunity



Electrical fast transient/burst immunity



Surge immunity



Immunity to conducted disturbances, induced by radio-frequency fields



Power frequency magnetic field immunity



Voltage dips, short interruptions and voltage variations immunity

